

Part A ►  
Introduction and  
Administration

WOOLLAHRA DEVELOPMENT CONTROL PLAN 2015



# Chapter A1 Introduction

Part A ► Introduction and Administration

CHAPTER A1 APPROVED ON 27 APRIL 2015  
AND COMMENCED ON 23 MAY 2015

Last amended on 26 July 2024



---

# Chapter A1 ▶ Introduction

## Contents

<b>A1.1</b>	<b>ABOUT THIS DEVELOPMENT CONTROL PLAN</b> .....	<b>1</b>
	A1.1.1 Name of development control plan.....	1
	A1.1.2 Commencement.....	1
	A1.1.3 Land where this plan applies.....	1
	A1.1.4 Development to which this plan applies.....	1
	A1.1.5 Objectives of this plan.....	1
	A1.1.6 Definitions.....	2
	A1.1.7 Relationship to other documents.....	2
	A1.1.8 Repealed development control plans.....	4
	A1.1.9 Savings and transitional provisions relating to development applications.....	5
<b>A1.2</b>	<b>STRUCTURE OF THIS DEVELOPMENT CONTROL PLAN</b> .....	<b>8</b>
<b>A1.3</b>	<b>THE DEVELOPMENT ASSESSMENT PROCESS</b> .....	<b>10</b>
	A1.3.1 Development that requires consent.....	10
	A1.3.2 How applications are assessed.....	11
	A1.3.3 How applications are determined.....	11
<b>A1.4</b>	<b>LIST OF AMENDMENTS</b> .....	<b>12</b>



---

## A1.1 About this development control plan

### A1.1.1 Name of development control plan

---

This plan is Woollahra Development Control Plan 2015 (DCP).

This DCP has been prepared consistent with Part 3, Division 6 of the *Environmental Planning and Assessment Act 1979* (EP&A Act) and the *Environmental Planning and Assessment Regulation 2000* (Regulation).

### A1.1.2 Commencement

---

This plan was adopted by Council on 27 April 2015 and commenced on 23 May 2015.

### A1.1.3 Land where this plan applies

---

This plan applies to all land within the Woollahra Municipality.

### A1.1.4 Development to which this plan applies

---

This plan applies to development requiring consent under the Woollahra Local Environmental Plan 2014 (Woollahra LEP 2014).

Under section 79C of the EP&A Act, Council is required to take into consideration the relevant provisions of any applicable DCP when determining an application for development.

### A1.1.5 Objectives of this plan

---

The Woollahra DCP is Council's main non-statutory document for regulating development, establishing the detailed planning and design guidelines for development across the municipality.

The overarching objectives of the DCP are:

- O1 To give effect to the aims of Woollahra LEP 2014.
- O2 To facilitate development that is permissible under Woollahra LEP 2014 with reference to the unique characteristics of the area where the development is proposed.
- O3 To achieve the objectives contained in Woollahra LEP 2014.
- O4 To establish controls that provide a balance between flexibility and certainty in the development assessment process.

O5 (Repealed)

O6 To establish a consistent set of definitions for terms used in the DCP.

Note: In addition to these overarching objectives, the objectives in each chapter of the DCP also apply to development.

### A1.1.6 Definitions

---

The definitions in Chapter A3 of this part define words and expressions for the purpose of this DCP. Where specified in Chapter A3, a word or expression used in this DCP can have the same meaning as it has in Woollahra LEP 2014.

### A1.1.7 Relationship to other documents

---

#### State environmental planning policies

State environmental planning policies (SEPPs) may apply to the land to which this DCP applies. Where this occurs, the statutory provisions of those SEPPs prevail over this DCP.

Clause 6A of SEPP No 65 Design Quality of Residential Apartment Development sets out the relationship between certain provisions contained in Parts 3 and 4 of the Apartment and Design Guide (NSW Department of Planning and Environment, June 2015) and provisions in a development control plan. Clause 6A makes the objectives, design criteria and guidelines for the following eight matters in the Apartment and Design Guide prevail over a DCP. The eight matters are:

Visual privacy (Part 3F)

Solar and daylight access (Part 4A)

Natural ventilation (Part 4B)

Ceiling heights (Part 4C)

Apartment size and layout (Part 4D)

Private open space and balconies (Part 4E)

Common circulation and spaces (Part 4F)

Storage (Part 4G)

Those provisions in Woollahra DCP 2015 that specify requirements, standards or controls that relate to any of the eight matters listed in clause 6A and contained in Parts 3 and 4 of the Apartment Design Code have no effect in the assessment and determination of a development application for development to which SEPP No 65 applies.

All other provisions of Woollahra DCP 2015 can be applied to the assessment and determination of a DA for development to which SEPP No 65 applies.



## Woollahra LEP 2014

This DCP supplements the requirements of Woollahra LEP 2014 and must be read in conjunction with the LEP. If there is any inconsistency between this DCP and Woollahra LEP 2014, the LEP prevails.

## Woollahra Community Participation Plan

Division 2.6 of the EP&A Act sets out the mandatory community participation requirements with respect to the exercise of relevant planning functions. It states that the mandatory requirements are those identified in:

- ▶ Part 1 Schedule 1 of the EP&A Act, and
- ▶ a community participation plan prepared under Division 2.6.

The Woollahra Community Participation Plan sets out how and when Council will undertake community participation when exercising relevant planning functions. This includes notification of development applications and applications to modify a development consent.

## Contributions plans

Section 94 of the EP&A Act contains provisions that allow Council to impose, as a condition of development consent or as a condition of a Complying Development Certificate, a requirement that the applicant dedicate land free of cost, or pay a monetary contribution, or both. This is in order to meet demand for public amenities and public services, the demand for which would be generated by the proposed development.

Section 94A of the EP&A Act contains provisions that allow Council to impose, as a condition of development consent or as a condition of a Complying Development Certificate, a requirement that the applicant pay a levy based on a percentage of the proposed cost of carrying out the development.

These contributions are used for providing, extending or augmenting public facilities such as recreational open space or public car parking. The development contributions plans supplement the provisions of Woollahra LEP 2014 and DCP.

---

### A1.1.8 Repealed development control plans

---

This DCP repeals the following DCPs:

- ▶ Woollahra Residential DCP 2003;
- ▶ Paddington Heritage Conservation Area DCP 2008;
- ▶ Woollahra Heritage Conservation Area DCP 2003;
- ▶ Watsons Bay Heritage Conservation Area DCP 2003;
- ▶ Double Bay Centre DCP 2002;
- ▶ Edgecliff Commercial Centre DCP 1995;
- ▶ Rose Bay Centre DCP 2000;
- ▶ Neighbourhood Centres DCP 2009;
- ▶ 13 Albert Street, Edgecliff DCP (Monte Oliveto) 2000;
- ▶ Babworth House DCP 1999 (103 Darling Point Road, Darling Point);
- ▶ Bishops court DCP 1995 (11 Greenoaks Avenue, Darling Point);
- ▶ 9 Cooper Park Road, Bellevue Hill DCP 1995;
- ▶ 9a Cooper Park Road, Bellevue Hill DCP 2014;
- ▶ Hawthornden DCP 1996 (6-12 Roslyndale Avenue, Woollahra);
- ▶ Kilmory DCP 2002 (6 Wentworth Street, Point Piper);
- ▶ 188 Oxford Street, Paddington and Part Lot 1 DP 215537 DCP 1997;
- ▶ 118 Wallis Street, Woollahra DCP 1995;
- ▶ Advertising and Notification DCP 2007;
- ▶ Exempt and Complying DCP 2005;
- ▶ Parking DCP 2011;
- ▶ Access DCP 2004;
- ▶ Contaminated Land DCP 2010;
- ▶ Site Waste Minimisation and Management DCP 2010;
- ▶ Child Care Centres DCP 2006;
- ▶ Educational Establishments DCP 2012; and
- ▶ Woollahra Telecommunications and Radiocommunications DCP 2004;
- ▶ Draft Flood Risk Management DCP; and
- ▶ Draft Stormwater Drainage Management DCP.

This DCP also repeals various policies and codes including: Code for Advertising (1987), Development Control Guidelines for the Provision of Foreshore Open Space and Access (1991), Private Stormwater Code (2009) and the Landscape Code (1988).

---

### A1.1.9 Savings and transitional provisions relating to development applications

---

Despite Section 1.1.8 regarding the repeal of DCPs, policies and codes, the DCPs listed in Section 1.1.8 above will continue to apply to development applications (DAs), applications to modify development consents and applications for review of a determination, that were made prior to but not determined on the date of commencement of this DCP.

This DCP (as commenced on 23 May 2015) continues to apply to development applications, applications to modify consents under section 96 of the EP&A Act and applications for review of determinations under section 82A of the EP&A Act that were made prior to but not determined before the commencement of Amendment No 1 to this DCP.

This DCP (as commenced on 23 May 2015) continues to apply to development applications, applications to modify consents under section 96 of the EP&A Act and applications for review of determinations under section 82A of the EP&A Act that were made prior to but not determined before the commencement of Amendment No 2 to this DCP.

This DCP (as commenced on 23 May 2015) continues to apply to development applications, applications to modify consents under section 96 of the EP&A Act and applications for review of determinations under section 82A of the EP&A Act that were made prior to but not determined before the commencement of Amendment No 3 to this DCP.

This DCP (as commenced on 23 May 2015) continues to apply to development applications, applications to modify consents under section 96 of the EP&A Act and applications for review of determinations under section 82A of the EP&A Act that were made prior to but not determined before the commencement of Amendment No 4 to this DCP.

This DCP (as commenced on 23 May 2015) continues to apply to development applications, applications to modify consents under section 4.55 of the EP&A Act and applications for review of determination under Division 8.2 Reviews of the EP&A Act that were made prior to but not determined before the commencement of Amendment No 7 to this DCP.

This DCP (as commenced on 23 May 2015) continues to apply to development applications, applications to modify consents under section 4.55 of the EP&A Act and applications for review of determination under Division 8.2 Reviews of the EP&A Act that were made prior to but not determined before the commencement of Amendment No. 8 to this DCP.

This DCP (as commenced on 23 May 2015) continues to apply to development applications, applications to modify consents under section 4.55 of the EP&A Act and applications for review of determination under Division 8.2 Reviews of the EP&A Act that were made prior to but not determined before the commencement of Amendment No 9 to this DCP.

This DCP (as commenced on 23 May 2015) continues to apply to development applications, applications to modify consents under section 4.55 of the EP&A Act and applications for review of determinations under Division 8.2 Reviews of the EP&A Act that were made prior to but not determined before the commencement of Amendment No 10 to this DCP.

This DCP (as commenced on 23 May 2015) continues to apply to development applications, applications to modify consents under section 4.55 of the EP&A Act and applications for review of

---

---

determination under Division 8.2 Reviews of the EP&A Act that were made prior to but not determined before the commencement of Amendment No 11 to this DCP.

This DCP (as commenced on 23 May 2015) continues to apply to development application to modify consents under section 4.55 of the EP&A Act and applications for review of determination under Division 8.2 Reviews of the EP&A Act that were made prior to but not determined before the commencement of Amendment No 13 to this DCP.

This DCP (as commenced on 23 May 2015) continues to apply to development application to modify consents under section 4.55 of the EP&A Act and applications for review of determination under Division 8.2 Reviews of the EP&A Act that were made prior to but not determined before the commencement of Amendment No 5 to this DCP.

This DCP (as commenced on 23 May 2015) continues to apply to development application to modify consents under section 4.55 of the EP&A Act and applications for review of determination under Division 8.2 Reviews of the EP&A Act that were made prior to but not determined before the commencement of Amendment No 12 to this DCP.

This DCP (as commenced on 23 May 2015) continues to apply to development application to modify consents under section 4.55 of the EP&A Act and applications for review of determination under Division 8.2 Reviews of the EP&A Act that were made prior to but not determined before the commencement of Amendment No 15 to this DCP.

This DCP (as commenced on 23 May 2015) continues to apply to development applications, applications to modify consents under section 4.55 of the EP&A Act and applications for review of determination under Division 8.2 Reviews of the EP&A Act that were made prior to but not determined before the commencement of Amendment No 14 to this DCP.

This DCP (as commenced on 23 May 2015) continues to apply to development applications, applications to modify consents under section 4.55 of the EP&A Act and applications for review of determination under Division 8.2 Reviews of the EP&A Act that were made prior to but not determined before the commencement of Amendment No 16 to this DCP.

This DCP (as commenced on 23 May 2015) continues to apply to development applications, applications to modify consents under section 4.55 of the EP&A Act and applications for review of determination under Division 8.2 Reviews of the EP&A Act that were made prior to but not determined before the commencement of Amendment No 17 to this DCP.

This DCP (as commenced on 23 May 2015) continues to apply to development applications, applications to modify consents under section 4.55 of the EP&A Act and applications for review of determination under Division 8.2 Reviews of the EP&A Act that were made prior to but not determined before the commencement of Amendment No 18 to this DCP.

This DCP (as commenced on 23 May 2015) continues to apply to development applications, applications to modify consents under section 4.55 of the EP&A Act and applications for review of determination under Division 8.2 Reviews of the EP&A Act that were made prior to but not determined before the commencement of Amendment No 19 to this DCP.

This DCP (as commenced on 23 May 2015) continues to apply to development applications, applications to modify consents under section 4.55 of the EP&A Act and applications for review of

---

determination under Division 8.2 Reviews of the EP&A Act that were made prior to but not determined before the commencement of Amendment No 20 to this DCP.

This DCP (as commenced on 23 May 2015) continues to apply to development applications, applications to modify consents under section 4.55 of the EP&A Act and applications for review of determination under Division 8.2 Reviews of the EP&A Act that were made prior to but not determined before the commencement of Amendment No 21 to this DCP.

This DCP (as commenced on 23 May 2015) continues to apply to development applications, applications to modify consents under section 4.55 of the EP&A Act and applications for review of determination under Division 8.2 Reviews of the EP&A Act that were made prior to but not determined before the commencement of Amendment No 23 to this DCP.

This DCP (as commenced on 23 May 2015) continues to apply to development applications, applications to modify consents under section 4.55 of the EP&A Act and applications for review of determination under Division 8.2 Reviews of the EP&A Act that were made prior to but not determined before the commencement of Amendment No 25 to this DCP.

This DCP (as commenced on 23 May 2015) continues to apply to development applications, applications to modify consents under section 4.55 of the EP&A Act and applications for review of determination under Division 8.2 Reviews of the EP&A Act that were made prior to but not determined before the commencement of Amendment No 24 to this DCP.

This DCP (as commenced on 23 May 2015) continues to apply to development applications, applications to modify consents under section 4.55 of the EP&A Act and applications for review of determination under Division 8.2 Reviews of the EP&A Act that were made prior to but not determined before the commencement of Amendment No 26 to this DCP.

## A1.2 Structure of this development control plan

This DCP contains seven parts, and comprises chapters within each part. The content structure of the DCP is illustrated in the table below.

Applicants and designers must read all applicable parts of the DCP to ensure they have met the DCP's requirements.

Woollahra DCP 2014	Where the parts apply
<b>Part A: Introduction and Administration</b> A1 Introduction A2 (Repealed) A3 Definitions	<b>Part A</b> applies to all DAs.  It contains information for all applications including the dictionary that defines the words and expressions used in this DCP.
<b>Part B: General Residential</b> B1 Residential Precincts B2 Neighbourhood Heritage Conservation Areas B3 General Development Controls	<b>Part B</b> applies to DAs proposed on land located within the residential precincts of Darling Point, Double Bay, Wallaroy, Manning Road, Point Piper, Bellevue Hill South, Bellevue Hill North, Rose Bay, Vaucluse West, and Vaucluse East or within the neighbourhood heritage conservation areas of Etham Avenue, Darling Point Road, Mona Road, Loftus Road and Mona Road, Aston Gardens, Victoria Road, Balfour Road, Beresford Estate, Rose Bay Gardens Estate, Kent Road and Bell Street.
<b>Part C: Heritage Conservation Areas</b> C1 Paddington HCA C2 Woollahra HCA C3 Watsons Bay HCA	<b>Part C</b> applies to DAs proposed on land located within the heritage conservation areas of Paddington, Woollahra and Watsons Bay.
<b>Part D: Business Centres</b> D1 Neighbourhood Centres D2 Mixed Use Centres D3 General Controls for Neighbourhood and Mixed Use Centres D4 Edgecliff Centre D5 Double Bay Centre D6 Rose Bay Centre	<b>Part D</b> applies to DAs proposed on land zoned Edgecliff, Double Bay and Rose Bay Centres, as well as to land zoned E1 Local Centre or MU1 Mixed Use under Woollahra LEP 2014.

Woollahra DCP 2014	Where the parts apply
<p><b>Part E: General Controls for All Development</b></p> <ul style="list-style-type: none"> <li>E1 Parking and Access</li> <li>E2 Stormwater and Flood Risk Management</li> <li>E3 Tree Management</li> <li>E4 Contaminated Land</li> <li>E5 Waste Management</li> <li>E6 Sustainability</li> <li>E7 Signage</li> <li>E8 Adaptable Housing</li> </ul>	<p><b>Part E</b> contains general controls which can apply to development irrespective of location.</p> <p>It establishes controls that all applications must consider.</p>
<p><b>Part F: Land Use Specific Controls</b></p> <ul style="list-style-type: none"> <li>F1 Child Care Centres</li> <li>F2 Educational Establishments</li> <li>F3 Licensed Premises</li> <li>F4 Telecommunications</li> </ul>	<p><b>Part F</b> applies to DAs relating to specific development types.</p> <p>The controls in Part F apply in addition to the controls in Parts B, C or D (as relevant).</p>
<p><b>Part G: Site-Specific Controls</b></p> <ul style="list-style-type: none"> <li>G1 Babworth House, Darling Point</li> <li>G2 Kilmory, Point Piper</li> <li>G3 Hawthornden, Woollahra</li> <li>G4 9a Cooper Park Road, Bellevue Hill</li> <li>G5 3-9 Sisters Lane, Edgecliff</li> <li>G6 4A Nelson Street and 118 Wallis Street, Woollahra</li> <li>G7 Former Royal Women’s Hospital, Paddington</li> <li>G8 252-254 New South Head Road, Double Bay</li> </ul>	<p><b>Part G</b> applies to DAs proposed on specific sites.</p> <p>The controls in Part G apply in addition to the controls in Parts B, C or D (as relevant).</p>

## A1.3 The development assessment process

Development and building works can be classified as exempt development, complying development, or development which requires consent from the relevant planning authority, which in most cases is Council.

Exempt development applies to minor development which does not require any approval. Complying development requires a complying development certificate to be issued by a principal certifying authority, which can be either Council or a private certifier.

Development that is exempt or complying development is set out in:

- ▶ Woollahra LEP 2014 (Schedule 2 and 3); and
- ▶ Various SEPPs including: *State Environmental Planning Policy (Exempt and Complying Development Codes) 2008*, *State Environmental Planning Policy (Infrastructure) 2007*, and *SEPP (Affordable Rental Housing) 2009*.

All other development requires consent. This DCP applies to development that requires consent.

Applicants should ensure development complies with the objectives and controls in both the LEP and this DCP.

### A1.3.1 Development that requires consent

In the Woollahra Municipality, due to the topography, proximity to the harbour and the nature of the development proposals, development consent from Council is usually required for the following activities, unless otherwise specified in a SEPP:

- ▶ to erect a new building or structure, or to add to or alter an existing building;
- ▶ to carry out development relating to a heritage item listed under Woollahra LEP 2014;
- ▶ to demolish a building;
- ▶ to change the use of an existing building or parcel of land to another use;
- ▶ to subdivide land or strata subdivide a building; and
- ▶ to carry out earthworks, excavation or filling.

Applicants are strongly advised to make an appointment for a formal pre-DA consultation with Council's Assessment Officers before detailed plans for the proposal are drawn up. This will help to identify important issues at an early stage and avoid later problems in the assessment process.

Before lodging a development application, applicants must also consider whether the proposal will require other approvals or licences from a NSW Government agency, in addition to Council's development consent. In these cases, Council will refer the application to the relevant agency so that there is an integrated assessment of the proposal. These referral agencies include the Roads and Maritime Services, Office of Environment & Heritage and the Department of Primary Industries.

To assist applicants, Council has also prepared a DA Guide which explains how to prepare a development application.



---

### A1.3.2 How applications are assessed

---

Development applications are assessed by Council under the EP&A Act. Council assesses applications on their merits having regard to Woollahra LEP 2014 and this DCP.

However, compliance with Woollahra LEP 2014 and this DCP does not guarantee Council's approval. In particular, the following factors in section 79C of the EP&A Act must also be taken into account:

- ▶ the provisions of any other environmental planning instrument and any other development control plan applying to the land;
- ▶ the provisions of any planning agreement that has been entered into under section 93F of the EP&A Act, or any draft planning agreement that a developer has offered to enter into under section 93F;
- ▶ any relevant provisions of the Regulation;
- ▶ the provisions of any coastal zone management plan (within the meaning of the *Coastal Protection Act 1979*) that apply to the land to which the development application relates;
- ▶ the likely impacts of that development, including environmental impacts on both the natural and built environments, and social and economic impacts in the locality;
- ▶ the suitability of the site for the development;
- ▶ any submissions made in accordance with the EP&A Act or the Regulation; and
- ▶ the public interest.

---

### A1.3.3 How applications are determined

---

Development applications can be determined at a local government level in one of four ways depending on the significance of the proposal, the level of non-conformity with Council's development controls and the number of objections received:

1. Delegated determination by a Council officer.
2. Determination by the Application Assessment Panel, which comprises senior Council officers.
3. Determination by the Woollahra Local Planning Panel, which comprises three approved independent persons with relevant expertise and a representative of the local community who is not a councillor or mayor.
4. Determination by the relevant Sydney district and regional planning panel, which comprises three members appointed by the Minister and two council nominees.

## A1.4 List of amendments

Amendment	Date of approval and commencement	Description of amendment
<b>No 1</b>	Date approved - 12 December 2016  Date commenced - 21 December 2016	Replace Chapter E1 Parking and Access updating existing provisions and inserting new provisions for vehicle parking and access
<b>No 2</b>	Date approved - 10 April 2017  Date commenced - 19 April 2017	Replace Chapter B3 General Development Controls inserting new objectives for design excellence, simplify setback controls and other minor amendments relating to wall height controls, acoustic and visual privacy, on-site parking, landscaping, swimming pools, outbuildings, fence and battle-axe lot controls
<b>No 3</b>	Date approved - 26 November 2018  Date commenced - 2 January 2019	Amend chapter B3 General Development controls to insert a new section called B3.5.5 - Internal Amenity to ensure that rooms in a dwelling, particularly rooms that are located below natural ground level, have high levels of indoor residential amenity for health and well-being.
<b>No 4</b>	Date approved - 26 November 2018  Date commenced - 2 January 2019	Amend Chapter B3 General Development Controls by amending and inserting various objectives, controls, introductions and notes relating to: <ul style="list-style-type: none"> <li>• Roof forms and roof structures</li> <li>• Plant equipment (including lifts and lift over runs)</li> <li>• Planting on elevated areas</li> <li>• Use of reflective material.</li> </ul>
<b>No 5</b>	Date approved - 26 October 2020  Date commenced - 7 December 2020	The amendment responds to the introduction of the Low Rise Housing Diversity Code.  The amendments are distributed throughout the DCP and insert references to the new housing types of Manor house and Multi dwelling housing (terraces) alongside existing references to residential flat buildings and multi dwelling housing.
<b>No 7</b>	Date approved - 11 November 2019  Date commenced - 2 January 2020	Chapter A3 Definitions: Amend definitions for “infill” and “pavilion”. Insert new definition for “courtyard”.  Chapter C1 Paddington Heritage Conservation Area: Amend and insert various objectives, controls, introductions and notes relating to single storey buildings, multi-storey terrace style housing, infill development and general controls for all development.

Amendment	Date of approval and commencement	Description of amendment
<b>No 8</b>	<p>Date approved - 9 December 2019</p> <p>Date commenced - 20 January 2020</p>	<p>Amend Chapters D5 Double Bay Centre, E5 Waste Management and F3 Licensed Premises by modifying and amending various introductions, controls and objectives to:</p> <ul style="list-style-type: none"> <li>• Address potential tensions between business activities and residential amenity in Double Bay.</li> <li>• Insert examples of design solutions that could reduce noise transmission in Double Bay.</li> <li>• Address noise and nuisance arising from waste and recycling collections.</li> <li>• Amend bin sizes and types for Paddington and West Woollahra.</li> </ul>
<b>No 9</b>	<p>Date approved - 11 November 2019</p> <p>Date commenced - 2 January 2020</p>	<p>Amend Chapter A1 by inserting additional savings and transitional provisions.</p> <p>Amend Chapter E1 Parking and Access by modifying and amending various sections, controls and objectives to:</p> <ul style="list-style-type: none"> <li>• Update electric vehicle circuitry controls to reflect evolving industry and policy development.</li> <li>• Insert mandatory requirements for electric circuitry to accommodate future installation of electric vehicle charging points.</li> <li>• Insert mandatory requirements for electric vehicle charging points in certain developments.</li> </ul>
<b>No 10</b>	<p>Date approved - 25 November 2019</p> <p>Date commenced - 2 January 2020</p>	<p>Repeal Chapter A2 Advertising and Notifications and amend Chapter A1 General Development Controls to remove references to the repealed Chapter A2 and insert relevant references to the Woollahra Community Participation Plan.</p>
<b>No 11</b>	<p>Date approved - 24 February 2020</p> <p>Date commenced - 16 March 2020</p>	<p>Amend Chapter A1 by inserting additional savings and transitional provisions.</p> <p>Amend Chapter D4 Edgecliff Centre, D5 Double Bay Centre and D6 Rose Bay Centre by adding various sections, controls and objectives for public art in major development.</p>
<b>No 12</b>	<p>Date approved - 22 February 2021</p> <p>Date commenced - 12 April 2021</p>	<p>Amend Chapter C1 Paddington Heritage Conservation Area by inserting additional objectives and controls relating to the protection of pub buildings.</p>

Amendment	Date of approval and commencement	Description of amendment
<b>No 13</b>	Date approved - 29 September 2020	Chapter A3 Definitions: insert the definition for “courtyard housing”. Delete the definition for “pavilion”.
	Date commenced - 12 October 2020	Chapter C1 Paddington Heritage Conservation Area: Amend clause 1.3.1 Single storey buildings, clause 1.4.3 Rear elevations, rear additions, significant outbuildings and yards and Table 8 in clause 1.5.8 Materials, finishes and details. Amendments include: <ul style="list-style-type: none"> <li>replacing the definition of “pavilion” with “courtyard housing”</li> <li>adding and amending controls and diagrams for rear additions to single storey buildings.</li> </ul>
<b>No 14</b>	Date approved - 26 July 2021	Amend Part B Chapter B1 and B3; Part C Chapters C1, C2 and C3 by modifying and amending various sections, controls and objectives to strengthen provisions for Inter-War flat buildings and timber buildings in Paddington and Watsons Bay.
	Date commenced - 30 August 2021	
<b>No 15</b>	Date approved - 22 March 2021	Amend Chapter A1 by inserting additional savings and transitional provisions.
	Date commenced - 12 April 2021	Amend Part B Chapter B3; Part C Chapters C1, C2 and C3; Part D Chapter D3 and Part G Chapter G4 by modifying and amending various sections, controls and objectives to strengthen controls for air-conditioning and other mechanical plant equipment to help protect streetscape character and amenity.
<b>No 16</b>	Date approved - 26 July 2021	Amend Part B Chapter C1 by modifying and amending various sections, controls and objectives affecting single storey buildings, multi-storey terrace style housing, infill development, side elevations and additions, rear elevations, roof forms and lofts over garages and studios.
	Date commenced - 30 August 2021	
<b>No 17</b>	Date approved - 26 July 2021	Amend Chapter A1 by inserting additional savings and transitional provisions.
	Date commenced - 30 August 2021	Amend Part B Chapter B3; Part C Chapters C1, C2 and C3; Part D Chapter D3, D4, D5 and D6 to strengthen controls for fire hydrant systems to address streetscape character and amenity impacts.
<b>No 18</b>	Date approved - 25 October 2021	Amend Chapter D5 Double Bay Centre, section D5.6.7 Geotechnology and hydrogeology by deleting this section and combine with Chapter E2 Stormwater and Flood Risk Management section E2.2.10 Groundwater (hydrogeology).
	Date commenced - 6 December 2021	Amend Chapter E2 Stormwater and Flood Risk Management, section E2.2.10 Groundwater (hydrogeology).

Amendment	Date of approval and commencement	Description of amendment
<b>No 19</b>	Date approved - 25 October 2021  Date commenced - 6 December 2021	Amend Chapter A3 Definitions and Chapter B2 by modifying and amending various sections, controls and objectives to strengthen provisions for Neighbourhood HCAs.
<b>No 20</b>	Date approved - 14 November 2022  Date commenced - 5 December 2022	Amend Chapter B3 by modifying the objectives and controls relating to excavation works.
<b>No 21</b>	Date approved - 28 November 2022  Date commenced - 14 July 2023	Amend Chapters B3 and E3 to introduce urban greening requirements, remove floorplate controls for dwelling houses, semi-detached dwellings and dual occupancies that are being replaced by floor space ratio controls in the Woollahra Local Environmental Plan 2014, and other associated administrative changes.
<b>No 22</b>	Date approved - 9 October 2023  Date commenced - 27 October 2023	Amend Part G by inserting Chapter G8 - 252-254 New South Head Road, Double Bay and introducing controls and objectives to address environmental and other amenity impacts that could result from future development on the site.
<b>No 23</b>	Date approved - 15 November 2023  Date commenced - 8 December 2023	Amend Chapter A1 by inserting additional savings and transitional provisions.  Amend Part B Chapter B3; Part C Chapters C1, C2 and C3; Part D Chapters D3, D4, D5 and D6, by modifying and amending various sections, controls and objectives to address the amenity impacts of electrical infrastructure, including particularly substations.
<b>No 25</b>	Date approved 11 December 2023  Date commenced - 22 December 2023	Amend Chapter A1 by inserting additional savings and transitional provisions.  Amend Chapter A3 to insert a new definition of solar energy systems.  Amend Chapter E6 to modify controls relating to solar energy systems.  Amend Chapters B2, C2, C3 and D1 to made administrative changes in support of the above amendments.

Amendment	Date of approval and commencement	Description of amendment
<b>No.24</b>	Date approved 13 May 2024	Amend Chapter A1 by inserting additional savings and transitional provisions.
	Date commenced 31 May 2024	Amend Chapters A1, C1, D1, D2, D3, D4, E1, E7 and F3 by updating references to employment zone names (administrative only).
<b>No. 26</b>	Date approved 8 July 2024	Amend Chapter A1 by inserting additional savings and transitional provisions.
	Date commenced 26 July 2024	Amend Part B, Chapter B3, section B3.7.4, 'ancillary development - tennis courts' to include basketball and sports courts, and ensure they are appropriately located and designed.

# Chapter A2

## Advertising and Notification

Part A ► Introduction and Administration

CHAPTER A2 APPROVED ON 27 APRIL 2015

AND COMMENCED ON 23 MAY 2015

Repealed on 2 January 2020

# Chapter A3 Definitions

Part A ► Introduction and Administration

CHAPTER A3 APPROVED ON 27 APRIL 2015

AND COMMENCED ON 23 MAY 2015

Last amended on 22 December 2023





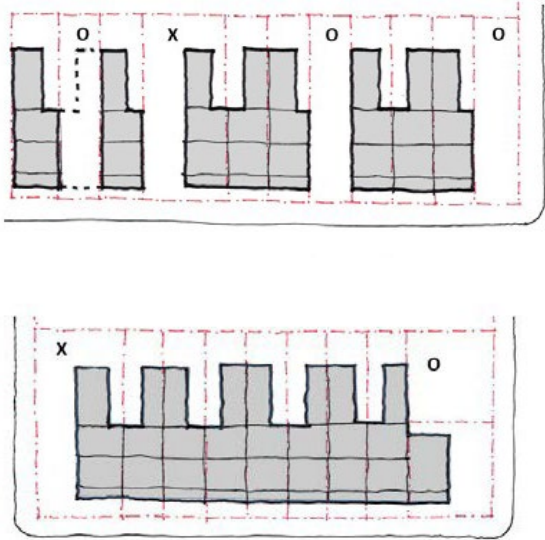
## A3.1 Definitions

<b>adaptation</b>	<p>as defined in the Burra Charter.</p> <p>Note: Means changing a place to suit the existing use or a proposed use.</p>
<b>aesthetic significance</b>	<p>as defined in NSW Heritage Manual, Heritage Office &amp; Department of Urban Affairs and Planning, Sydney, 1996 (NSW Heritage Manual) - Assessing Heritage Significance.</p> <p>Note: Important in demonstrating aesthetic characteristics and/or a high degree of creative or technical achievement.</p>
<b>alter</b>	<p>in relation to a heritage item or to a building or work within a heritage conservation area means:</p> <ul style="list-style-type: none"> <li>► make structural changes to the outside of the heritage item, building or work, or Inter-War flat building, or</li> <li>► make non-structural changes to the detail, fabric, finish or appearance of the outside of the heritage item, building or work, but not changes that involve the maintenance of the existing detail, fabric, finish and appearance of the outside of the heritage item, building or work.</li> </ul>
<b>amenity</b>	<p>as defined in Heritage Terms and Abbreviations (NSW Heritage Manual).</p> <p>Note: Refers to qualities of usefulness, comfort and pleasure in items and areas of the environment. Heritage arguments are often used incorrectly to defend items or areas when amenity considerations are more relevant and appropriate.</p>
<b>attached dwelling</b>	<p>as defined in Woollahra LEP 2014.</p> <p>Note: Within the Paddington, Woollahra and Watsons Bay HCA contexts, this commonly takes the form of a building known as a terrace, where the terrace is part of a group of three or more dwellings.</p>
<b>attic</b>	<p>as defined in Woollahra LEP 2014.</p>
<b>boat shed</b>	<p>as defined in Woollahra LEP 2014.</p>
<b>Building Code of Australia (BCA)</b>	<p>the Building Code of Australia (BCA) is Volumes One and Two of the National Construction Code (NCC). The BCA has been given the status of building regulation by all States and Territories.</p> <p>The BCA contains technical provisions for the design and construction of buildings and other structures, covering such matters as structure, fire resistance, access and egress, services and equipment, and energy efficiency as well as certain aspects of health and amenity.</p>
<b>building envelope</b>	<p>the three-dimensional space within which a building is to be confined.</p>

<b>building height</b>	as defined in Woollahra LEP 2014.
<b>building line</b>	as defined in Woollahra LEP 2014.
<b>Burra Charter (and its guidelines)</b>	the charter adopted by Australia International Council on Monuments and Sites (ICOMOS), which establishes the nationally accepted principles for the conservation of places of cultural significance.
<b>character</b>	the combination of features and qualities of a place.
<b>coastal inundation</b>	the storm-related flooding of coastal lands by ocean waters due to elevated still water levels (storm surge) and wave run-up.
<b>compatible use</b>	as defined in Heritage Terms and Abbreviations (NSW Heritage Manual). Note: A use for a heritage item which involves no change to its culturally significant fabric, changes which are substantially reversible or changes which make a minimal impact.
<b>conservation</b>	as defined in Heritage Terms and Abbreviations (NSW Heritage Manual). Note: All the processes of looking after an item so as to retain its cultural significance. It includes maintenance and may, according to circumstances, include preservation, restoration, reconstruction and adaptation and will be commonly a combination of more than one of these.
<b>conservation policy</b>	as defined in Heritage Terms and Abbreviations (NSW Heritage Manual). Note: A proposal to conserve a heritage item arising out of the opportunities and constraints presented by the statement of heritage significance and other considerations.
<b>context</b>	the particular built, natural, historical and/or social characteristics of a building or place's setting.
<b>contributory building</b>	a building that makes an important and significant contribution to the character and significance of the heritage conservation area. It has a reasonable to high degree of integrity and dates from a key development period of significance of a heritage conservation area. A building which: <ul style="list-style-type: none"> <li>▶ due to its materials, detailing, finishes, scale, form, siting and landscaping makes a positive impact and contribution to the streetscape character and to the cultural significance of the heritage conservation area; and</li> <li>▶ is from a significant historical period and is altered yet recognisable and reversible.</li> </ul>
<b>contributory item</b>	a building, work, archaeological site, tree or place and its setting, which contributes to the heritage significance of a conservation area.

<b>courtyard</b>	an area that is open to the sky and of sufficient size to be used as private open space. A courtyard does not include a lightwell or a breezeway.
<b>courtyard housing</b>	<p>a structure which:</p> <ul style="list-style-type: none"> <li>► must be wholly located at the rear of the existing principal building,</li> <li>► must be separated from the principal building by a courtyard</li> <li>► must be separated by a narrow, non-habitable lightweight linking structure, and</li> <li>► must be subsidiary in form and scale to the principal building.</li> </ul> <p>Courtyard housing is not infill development, or a garage, or a loft over a garage, or studio.</p>
<b>cultural landscape</b>	<p>as defined in Heritage Terms and Abbreviations (NSW Heritage Manual).</p> <p>Note: Those areas of the landscape which have been significantly modified by human activity. They include rural lands such as farms, villages and mining sites, as well as country towns.</p>
<b>cultural plantings</b>	plants including native plants that were planted for a deliberate purpose (see also ‘significant cultural plantings’).
<b>curtilage</b>	as defined in Woollahra LEP 2014.
<b>deep soil landscaped area</b>	<p>the area of the site that contains landscaped area which has no above ground, ground level or subterranean development.</p> <p>Note: ‘landscaped area’ is defined in Woollahra LEP 2014.</p>
<b>demolish</b>	as defined in Woollahra LEP 2014.
<b>dormer</b>	a structure comprising a window, roof and side walls projecting from a sloping roof.
<b>dual occupancy</b>	as defined in Woollahra LEP 2014.
<b>dwelling</b>	as defined in Woollahra LEP 2014.
<b>dwelling house</b>	as defined in Woollahra LEP 2014.
<b>Eastern suburbs banksia scrub</b>	vegetation within the Watsons Bay, Camp Cove and Sydney Harbour National Park areas, which is endemic to these areas.
<b>ecologically sustainable development</b>	has the same meaning as in the <i>Environmental Planning and Assessment Act 1979</i> .
<b>educational establishment</b>	as defined in Woollahra LEP 2014.

<b>excavation permit</b>	as defined in Heritage Terms and Abbreviations (NSW Heritage Manual).  Note: A permit issued by the Heritage Council of New South Wales under section 60 or section 140 of the <i>Heritage Act 1977</i> to disturb or excavate a relic.
<b>fabric</b>	physical material or substances. In the case of a building, fabric would include materials such as brick, stone, timber, mortar, glazing, iron, steel, terracotta and slate.
<b>façade</b>	the elevation of a building facing the street/s.
<b>floor space ratio</b>	as defined in Woollahra LEP 2014.
<b>form</b>	in relation to a building, means its overall shape and configuration of components.
<b>freeboard</b>	a factor of safety typically used in relation to the setting of flood planning levels. It compensates for uncertainties in the estimation of flood levels across the floodplain, such as wave action, localised hydraulic behaviour and impacts that are specific event related, such as levee and embankment settlement, and other effects such as sea level rise.
<b>gross floor area</b>	as defined in Woollahra LEP 2014.
<b>ground level (existing)</b>	as defined in Woollahra LEP 2014.
<b>group</b>	a number of related buildings that form a group, that may include pairs of buildings and terrace groups.  Groups of related buildings display shared characteristics such as an original builder, architectural style, form, scale and details.  In some instances, terrace groups can include sub-groups where a group comprises a range of buildings, e.g. corner commercial buildings integrated into terrace house groups.
<b>habitable room</b>	as defined in the Building Code of Australia (BCA).  Note: Habitable room means a room used for normal domestic activities, and:  a) includes a bedroom, living room, lounge room, music room, television room, kitchen, dining room, sewing room, study, playroom, family room and sunroom; but  b) excludes a bathroom, laundry, water closet, pantry, walk-in wardrobe, corridor, hallway, lobby, photographic darkroom, clothes-drying room, and other spaces of a specialised nature occupied neither frequently nor for extended periods.

<b>heritage conservation area</b>	as defined in Woollahra LEP 2014.
<b>heritage conservation management plan</b>	as defined in Woollahra LEP 2014.
<b>heritage impact statement</b>	as defined in Woollahra LEP 2014.
<b>heritage item</b>	as defined in Woollahra LEP 2014.
<b>heritage significance</b>	as defined in Woollahra LEP 2014.
<b>infill development</b>	<p>is the erection of a building that is:</p> <ul style="list-style-type: none"> <li>▶ constructed on an existing vacant registered allotment of land; and</li> <li>▶ does not include side, rear or front alterations and additions to an existing building.</li> </ul>  <p>O = Acceptable infill site X = Unacceptable infill site</p>
<b>integrity</b>	<p>as defined in Heritage Terms and Abbreviations (NSW Heritage Manual).</p> <p>Note: A heritage item is said to have integrity if its assessment and statement of significance is supported by sound research and analysis, and its fabric and curtilage are still largely intact.</p>
<b>Inter-War flat building</b>	a building of two or more storeys and containing two or more dwellings, constructed in the period from c.1918 to c.1950.

<b>intrusive development</b>	development which is inappropriate to the significant heritage character of a heritage conservation area due to its form, scale, bulk, materials and proportions and which adversely affects adjoining buildings, the streetscape and general character of the area.
<b>jetty</b>	as defined in Woollahra LEP 2014.
<b>landscaped area</b>	as defined in Woollahra LEP 2014.
<b>LEP</b>	Woollahra Local Environmental Plan 2014.
<b>local significance</b>	as defined in Heritage Terms and Abbreviations (NSW Heritage Manual). Note: Items of heritage significance which are fine examples, or rare, at the local community level.
<b>loggia</b>	an open sided, roofed space attached to the side of a building.
<b>maintenance</b>	as defined in Woollahra LEP 2014.
<b>manor house</b>	as defined in <i>State Environmental Planning Policy (Exempt and Complying Development Codes) 2008</i> .
<b>mixed use development</b>	as defined in Woollahra LEP 2014.
<b>movable heritage</b>	as defined in Heritage Terms and Abbreviations (NSW Heritage Manual). Note: Heritage items not fixed to a site or place (for example, furniture, locomotives and archives).
<b>multi dwelling housing</b>	as defined in Woollahra LEP 2014.
<b>multi dwelling housing (terraces)</b>	as defined in Woollahra LEP 2014.
<b>native vegetation</b>	has the same meaning as in the <i>Native Vegetation Act 2003</i> .
<b>natural ventilation</b>	ventilation by natural airflow, unassisted by mechanical means, through doors, operable windows and louvres.
<b>neutral buildings</b>	a building that does not contribute or does not detract from the significant character of the heritage conservation area.  A neutral building is: <ul style="list-style-type: none"> <li>▶ from a significant historical period, but altered in form, in an irreversible way; or</li> <li>▶ a sympathetic contemporary infill.</li> </ul>

<b>non-habitable room</b>	refer ‘habitable room’ in the Building Code of Australia (BCA).  Note: A non-habitable room is a bathroom, laundry, water closet, pantry, walk-in wardrobe, corridor, hallway, lobby, photographic darkroom, clothes-drying room, and other spaces of a specialised nature occupied neither frequently nor for extended periods.
<b>north facing</b>	the orientation range within 20° west and 30° east of true solar north.
<b>NSW Heritage Manual</b>	a document prepared by the NSW Heritage Office which comprises a series of publications explaining the three steps of the NSW Heritage Management System and how they can be applied.
<b>objectives</b>	define the intention of each control element and/or indicate the desired outcomes to be achieved in the completed development.
<b>original significant fabric</b>	the physical materials and substances belonging to the initial construction phase of a place that contribute to heritage significance.  In the case of a building, original significant fabric would include all the original materials of the principal building form and extant external materials of the secondary wing, if the form is intact and the external materials are substantially intact.
<b>parapet</b>	an upstanding wall or barrier placed at the edge of a platform, balcony or roof.
<b>passive solar design</b>	design principles that aim to prevent unwanted heat, in the form of sunlight, entering the building during summer and to maximise solar access into the building during winter. Building orientation, the location and treatment of glazing, thermal mass, insulation, and ventilation all work to exclude and dissipate heat in summer and retain and capitalise on heat in winter.
<b>place</b>	as defined in Heritage Terms and Abbreviations (NSW Heritage Manual).  Note: A site, area or landscape or group of works, together with associated structures, contents and surrounds.
<b>preservation</b>	as defined in Heritage Terms and Abbreviations (NSW Heritage Manual).  Note: Maintaining the fabric of a place in its existing state and retarding deterioration.
<b>principal elevation</b>	the elevation of a building that faces a public space. Buildings may contain more than one principal presenting elevation such as an A-typical triangular shaped lot.
<b>principal roof form</b>	the principal roof plane/s located over the principal building form (predominantly the front building section).

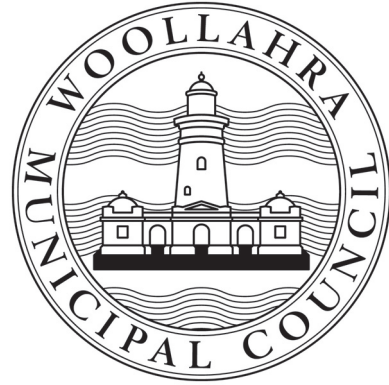


<b>private domain</b>	all land which is privately owned and which is not included in the public domain.
<b>private open space</b>	as defined in Woollahra LEP 2014.
<b>public domain</b>	all land which is owned by a public authority and includes roads, footpaths, laneways and parks.
<b>rarity</b>	as defined in Assessing Heritage Significance (NSW Heritage Manual). Note: Possesses uncommon, rare or endangered aspects of the area cultural or natural history.
<b>reconstruction</b>	as defined in Heritage Terms and Abbreviations (NSW Heritage Manual). Note: Returning a place as nearly as possible to a known earlier state by the introduction of new or old materials into the fabric (not to be confused with conjectural reconstruction).
<b>representativeness</b>	as defined in Assessing Heritage Significance (NSW Heritage Manual). Note: It is important in demonstrating the principal characteristics of a class of the area's cultural or natural places or cultural or natural environments.
<b>residential flat building</b>	as defined in Woollahra LEP 2014.
<b>restoration</b>	as defined in Heritage Terms and Abbreviations (NSW Heritage Manual). Note: Returning the existing fabric of a place to a known earlier state by removing accretions or by reassembling existing components without the introduction of new material.
<b>reverse skillion</b>	where the presenting outer edge of an attached skillion roof form is located at a height above the point of attachment or in the case of a single unattached roof plane where the highest presenting end of the roof plane contains an eave overhang.
<b>reviewable condition</b>	as defined in the <i>Environmental Planning and Assessment Act 1979</i> (s80A) Note: means any of the following: a) a condition that permits extended hours of operation (in addition to other specified hours of operation), b) a condition that increases the maximum number of persons permitted in a building (in addition to the maximum number otherwise permitted).
<b>roof terrace</b>	a trafficable roof of a building (or part thereof) (including a garage or carport) which has the potential to be used for the purpose of private open space, storage or roof garden and which is either open to the sky or partly covered by a non-continuous shade device.

<b>roofscape</b>	a view or expanse of roofs including their pitch and form, and elements such as chimneys, parapets, party walls, guttering and roof materials.
<b>row</b>	a continuous line of buildings. Attached housing or terrace style housing is predominantly constructed in rows.
<b>sandstone heath</b>	heath and scrub which is found on shallow exposed sandstone-derived soils which border the sea coast, and extend to varying distances inland, or where drainage is impeded by rock shelves or shale lenses.
<b>scale</b>	the size of a building and its relationship with surrounding buildings and landscape.
<b>seawall</b>	a structure placed partially or wholly along the land/water interface to protect the land from the sea or to stop accelerated erosion of the shoreline, but does not include a breakwater.
<b>secondary elevation</b>	those elevations behind the principal building form.
<b>semi-detached dwelling</b>	as defined in Woollahra LEP 2014.  Note: Within the Paddington and Woollahra HCA contexts, this commonly takes the form of a building known as a terrace, where the terrace is attached to only one other dwelling.
<b>sensitive marine environment</b>	the environment in which any of the following ecological communities exist along the harbour foreshore within the Woollahra Municipality, as identified in the Development Control Plan for <i>Sydney Regional Environmental Plan (Sydney Harbour Catchment) 2005</i> : <ul style="list-style-type: none"> <li>► rocky intertidal;</li> <li>► sandy intertidal;</li> <li>► grassland;</li> <li>► seagrass beds;</li> <li>► mixed sandy intertidal and rock shelf; and</li> <li>► mixed rocky intertidal and sand.</li> </ul>
<b>setback</b>	as defined in Woollahra LEP 2014 (refer to building line or setback).
<b>shopfront elevation</b>	the elevation to the street including the areas above and below an awning.
<b>side boundary fence</b>	a fence separating allotments or on a side street, in the case of a corner site, but does not include a fence within the street front zone.
<b>significant cultural plantings</b>	plants including native plants that were planted for a deliberate purpose and which reflect the taste or fashion of a particular period or were associated with a person or event of historical significance.

<b>significant tree</b>	a tree identified on Council’s significant tree register.
<b>significant views</b>	views and vistas from streets and public reserves which strongly contribute to a sense of place and cultural identity.
<b>site area</b>	as defined in Woollahra LEP 2014.
<b>soffit</b>	the lower face or visible surface of a ceiling, eave, projecting slab or the like.
<b>solar access</b>	the amount of direct access to sunlight enjoyed by a building, room or open space.
<b>solar energy system</b>	solar energy system means any of the following systems— a) a photovoltaic electricity generating system used for the primary purpose of generating electricity for a land use— i) carried out on the land on which the system is located, or ii) carried out by the owner of the system on adjoining land, b) a solar hot water system, c) a solar air heating system.
<b>spa pool</b>	as defined in the <i>Swimming Pools Act 1992</i> .
<b>State heritage significance</b>	as defined in the <i>Heritage Act 1977</i> .
<b>storey</b>	as defined in Woollahra LEP 2014.
<b>street alignment</b>	the horizontal shape of the street reserve boundary.
<b>street front zone</b>	comprises the front building elevation and visible roof, front yard, the side boundary fences in the front yard and the street boundary fence.
<b>street name inlays</b>	the (usually) red lettering insert in footpaths, kerbs or gutters found at many intersections to indicate the name of the respective street.
<b>streetscape</b>	encompasses both the public and private domain and includes the street design, its landscaping, traffic management treatments, surfaces, utility installations, all buildings abutting the street and their facades, associated landscaping, fences, paths, driveways and the like. The arrangement and integration of these components and their visual appearance determine the streetscape character.
<b>swimming pool</b>	as defined in the <i>Swimming Pools Act 1992</i> .

<p><b>terrace</b></p>	<p>is a style of housing. The buildings share a similar design and form and are linked by common party walls. In Woollahra LEP 2014, a terrace is defined as:</p> <ul style="list-style-type: none"> <li>▶ a semi-detached dwelling (where the terrace is only attached to only one other dwelling); or</li> <li>▶ an attached dwelling (where the terrace is part of a building that containing 3 or more dwellings).</li> </ul>
<p><b>unaltered</b></p>	<p>in relation to a building or group of buildings means that the building or group of buildings has retained its original form and character but may have minor changes including changes to windows and doors and some loss of detail that may be reversible.</p>
<p><b>unbuilt upon area</b></p>	<p>the area of the site not covered by the building footprint and any roofed structures, but excludes uncovered parking areas and driveways. Uncovered parking areas and driveways are not to be calculated as unbuilt upon area.</p>



## Part B ► General Residential

WOOLLAHRA DEVELOPMENT CONTROL PLAN 2015



# Chapter B1 Residential Precincts

Part B ► General Residential

CHAPTER B1 APPROVED ON 27 APRIL 2015  
AND COMMENCED ON 23 MAY 2015

Last amended on 30 August 2021





# Chapter B1 ▶ Residential Precincts

## Contents

- B1.1 INTRODUCTION ..... 1**
  - B1.1.1 Land where this chapter applies..... 1
  - B1.1.3 Objectives..... 2
- B1.2 DARLING POINT PRECINCT..... 5**
  - B1.2.1 Precinct character statement ..... 6
  - B1.2.2 Desired future character ..... 7
- B1.3 DOUBLE BAY PRECINCT ..... 9**
  - B1.3.1 Precinct character statement ..... 10
  - B1.3.2 Desired future character ..... 10
- B1.4 WALLAROY PRECINCT ..... 12**
  - B1.4.1 Precinct character statement ..... 13
  - B1.4.2 Desired future character ..... 13
- B1.5 MANNING ROAD PRECINCT..... 15**
  - B1.5.1 Precinct character description ..... 16
  - B1.5.2 Desired future character ..... 16
- B1.6 POINT PIPER PRECINCT..... 18**
  - B1.6.1 Precinct character statement ..... 19
  - B1.6.2 Desired future character ..... 19
- B1.7 BELLEVUE HILL SOUTH PRECINCT ..... 21**
  - B1.7.1 Precinct character statement ..... 22
  - B1.7.2 Desired future character ..... 22
- B1.8 BELLEVUE HILL NORTH PRECINCT ..... 24**
  - B1.8.1 Precinct character statement ..... 25
  - B1.8.2 Desired future character ..... 25
- B1.9 ROSE BAY PRECINCT ..... 28**
  - B1.9.1 Precinct character statement ..... 29
  - B1.9.2 Desired future character ..... 29
- B1.10 VAUCLUSE WEST PRECINCT ..... 31**
  - B1.10.1 Precinct character statement ..... 32
  - B1.10.2 Desired future character ..... 32
- B1.11 VAUCLUSE EAST PRECINCT..... 34**
  - B1.11.1 Precinct character statement ..... 35
  - B1.11.2 Desired future character ..... 35



## B1.1 Introduction

This is Chapter B1 of the General Residential (Part B) of the Woollahra Development Control Plan 2015 (DCP). It contains the precinct controls for 10 residential precincts.

This chapter seeks to ensure that development has regard to its context and is compatible with the desired future character for each precinct as described in this chapter.

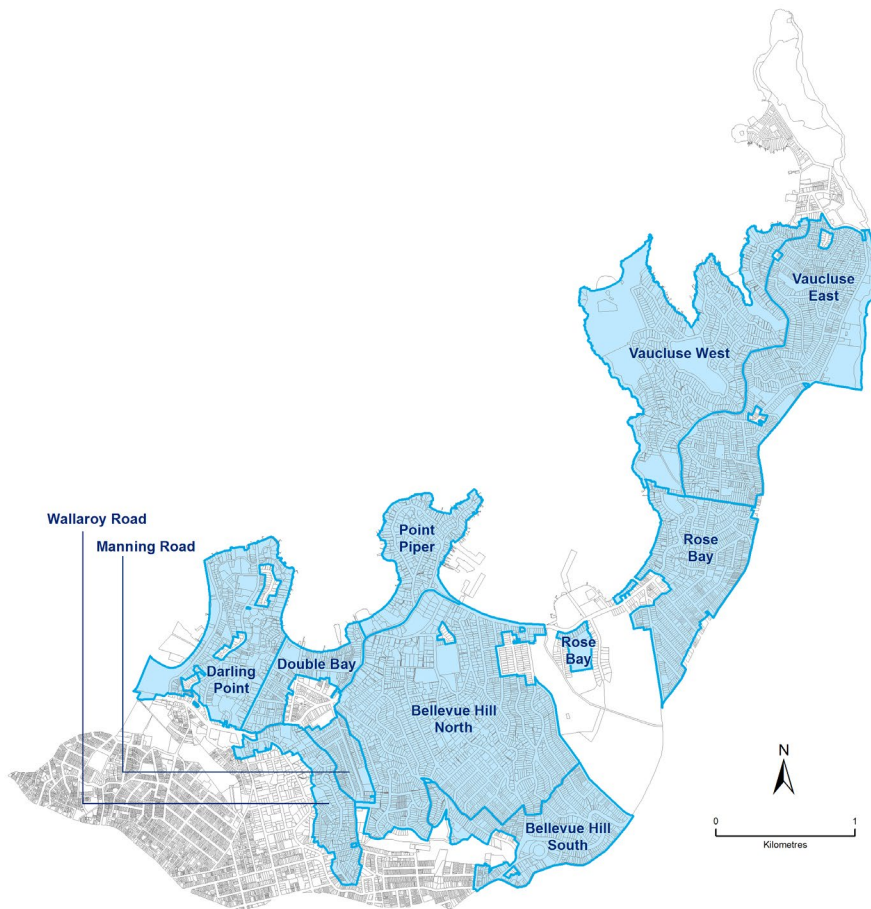
### B1.1.1 Land where this chapter applies

---

This chapter applies to the following residential precincts:

- ▶ Darling Point
- ▶ Double Bay
- ▶ Wallaroy
- ▶ Manning Road
- ▶ Point Piper
- ▶ Bellevue Hill South
- ▶ Bellevue Hill North
- ▶ Rose Bay
- ▶ Vaucluse West
- ▶ Vaucluse East

These precincts are identified on the map below. A separate map of each precinct is also provided in the relevant sections of this chapter.



### B1.1.2 Development to which this chapter applies

This chapter applies to development that requires development consent.

Generally this will be residential development, but may include other permitted uses such as child care centres, community facilities, educational establishments, neighbourhood shops and places of public worship, and other uses permitted in Woollahra LEP 2014.

### B1.1.3 Objectives

The objectives of this chapter are:

- 01 To ensure development reflects the desired future character of the precinct.
- 02 To preserve the significant features of individual precincts which contribute to their unique character.
- 03 To ensure that the design and siting of development suitably responds to the surrounding built form and natural features.

- 04 To limit impacts on the amenity of adjoining and adjacent development.
- 05 To ensure the preservation of significant view corridors and ridgelines.
- 06 To retain and reinforce tree canopies and landscape qualities.
- 07 To ensure that streetscape and scenic quality is preserved.

#### **B1.1.4 Relationship to other parts of the DCP**

---

This chapter is to be read in conjunction with the other parts of the DCP that are relevant to the development proposal, including:

- ▶ Part B: Chapter B2 Neighbourhood HCAs - this chapter contains objectives and controls that apply to development in a neighbourhood HCA.
- ▶ Part B: Chapter B3 General Development Controls.
- ▶ Part E: General Controls for All Development - this part contains chapters on Parking and Access, Stormwater and Flood Risk Management, Tree Management, Contaminated Land, Waste Management, Sustainability, Signage and Adaptable Housing.
- ▶ Part F: Land Use Specific Controls - this part contains chapters on Child Care Centres, Educational Establishments, Licensed Premises and Telecommunications.

---

### B1.1.5 How to use this chapter

---

The primary planning considerations for the residential precincts are set out in two chapters:

- ▶ Chapter B1 Residential Precincts; and
- ▶ Chapter B3 General Development Controls.

#### Chapter B1 Residential Precincts

Each section in this chapter represents a particular geographic area, called a precinct. Applicants only need to refer to the particular precinct that is relevant to their site.

Each precinct comprises the following elements:

- ▶ map showing the extent of the precinct;
- ▶ precinct character statement, providing a brief description of the precinct;
- ▶ desired future character, establishing the direction and outcomes required to be achieved through development in the precinct. This includes a list of streetscape character and key elements important to each precinct, and a list of desired future character objectives. The desired future character objectives describe the outcomes that are required to be achieved through development within the precinct.

Applicants need to demonstrate how their development fulfils the relevant objectives, and preserves or enhances the important character elements for the precinct, having particular regard to:

- ▶ surrounding building height, bulk and scale;
- ▶ any predominant architectural styles, roof forms, materials and colours;
- ▶ prevailing building lines;
- ▶ landscape and vegetation features;
- ▶ topography;
- ▶ view corridors;
- ▶ scenic quality; and
- ▶ adjacent heritage conservation areas or contributory items.

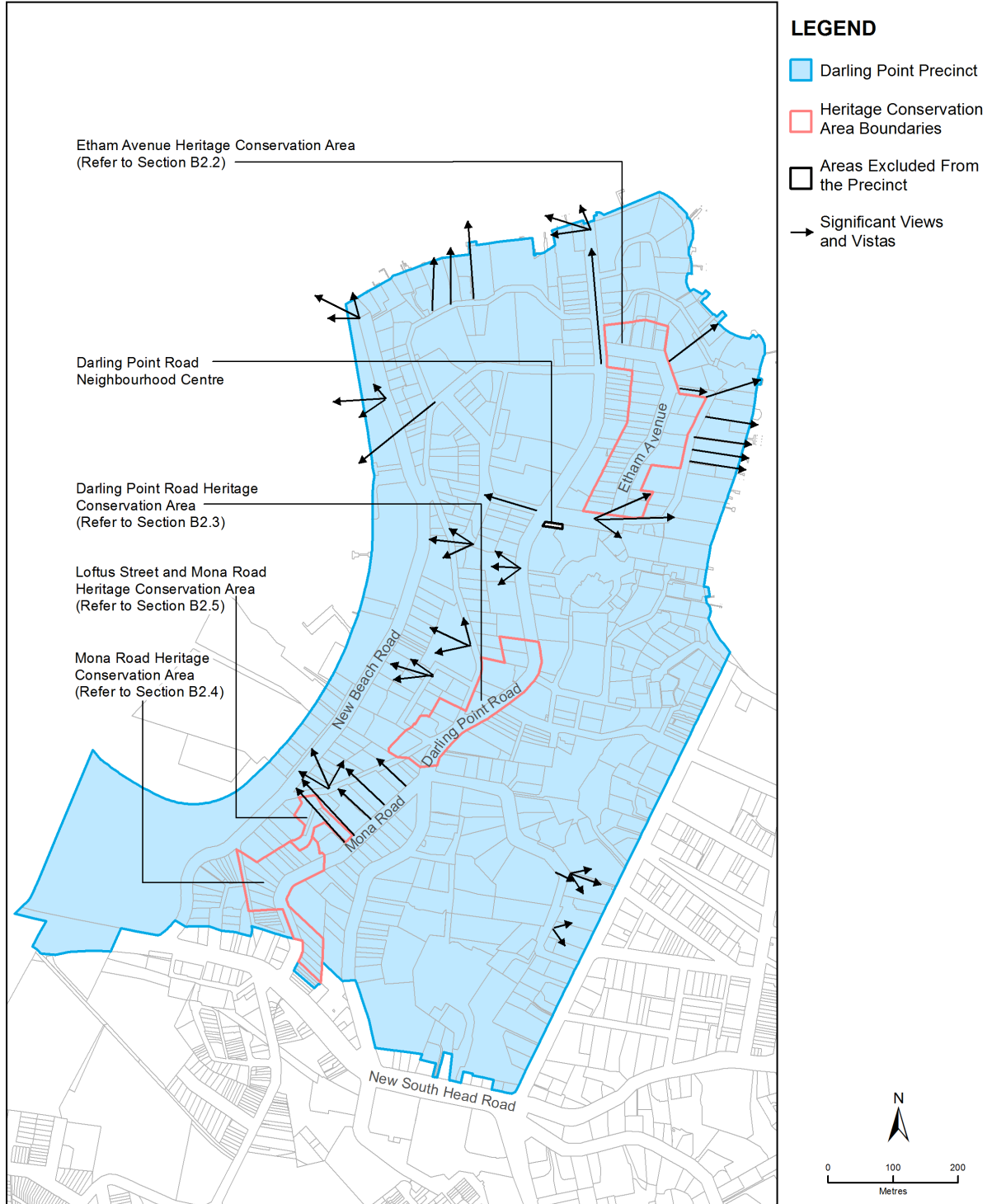
#### Chapter B3 General Development Controls

The general controls in Chapter B3 apply to all land where Chapter B1 applies.

Development is required to fulfil the relevant requirements of all the general controls. Unless otherwise indicated, where there is a disparity between the objectives and controls in Chapters B1 and B3, the precinct desired future character statements and objectives in this chapter takes precedence over the general objectives and controls.

## B1.2 Darling Point Precinct

MAP 2 Darling Point Precinct



---

### B1.2.1 Precinct character statement

---

The Darling Point precinct is located on a highly prominent peninsula on Sydney Harbour sited between Rushcutters Bay and Double Bay. Darling Point provides spectacular views to the harbour from both private houses and public spaces. The street trees and trees in private yards provide the peninsula with a soft landscape quality.

Significant landmarks within the precinct include: St Mark's church, Ascham School, the heritage properties of Babworth House and Bishops Court, harbourside reserves at McKell Park and Yarranabbe Park, and the heritage listed Sir David Martin Reserve which contains the Drill Hall, former HMAS Rushcutter and HMAS Rushcutter slipway.

The built environment is notable for the wide variety of architectural styles and housing types. The precinct also contains a significant number of heritage items (refer to Woollahra LEP 2014) and encompasses the heritage conservation areas at Etham Avenue, Darling Point Road, Mona Road and Loftus Road /Mona Road.

A significant element of the heritage items and heritage conservation areas is the siting of buildings within a landscaped setting. Additional planning provisions for the four neighbourhood heritage conservation areas within the Darling Point precinct are set out in Chapter B2 in this Part of the DCP.

Streets surrounding the ridgeline of Darling Point Road include residential flat buildings up to eight storeys, dwelling houses, semi-detached dwellings and groups of terraces (attached dwellings).

Existing groups of relatively intact period terraces that are not heritage items but contribute to the architectural diversity of the precinct, such as those along New Beach Road (11-14, 48-52 and 70-71), Ocean Avenue (71-73 and 77-81) and Darling Point Road (125-127).

In the post-war period, high rise residential towers of up to 20 storeys were developed along the ridgeline of Darling Point. Significantly, many of the towers contain extensive landscaped grounds and gardens which provide an openness and allow for distant views. Some of these towers are located along the waterfront and represent intrusive development when viewed from the Sydney Harbour.

Similarly other residential flat buildings that have not been designed to step down and follow the slope of the land, also present to the harbour as a sheer façade.

The Rushcutters Bay foreshore area comprises a mix of buildings, including heritage listed semi-detached dwellings on the south-eastern side of New Beach Road, as well as commercial uses relating to the marinas at Rushcutters Bay. These include the Cruising Yacht Club of Australia, Ship Chandlers, and d'Albora Marina.



---

### B1.2.2 Desired future character

---

The Darling Point precinct is an established residential area with a rich mixture of architectural styles and forms. Development is to retain the visual prominence of the tree canopy, particularly along the ridgeline of Darling Point Road.

Most development is in the form of alterations and additions to the existing housing stock.

Where a building comprises historic or aesthetic values, it is important that development reflects the scale of the existing built form and retains the character of the original building particularly in regard to the roof form, massing, details, materials and finishes. For example, the groups of period terraces at New Beach Road, Ocean Avenue and Darling Point Road should be retained and enhanced.

Development adjoining a contributory item or heritage conservation area is to have regard to the architectural values of the building and establish a sympathetic interface.

Where an existing building does not comprise historic or aesthetic value, sympathetic contemporary design is permitted.

Where new development occurs, the buildings are to provide a height, bulk, and scale compatible with those buildings that are predominantly two to four storeys in height, and have regard to the visual impact of the development from the harbour.

Existing intrusive high rise and tower developments are not to be reproduced.

On the low side of streets where existing development predominantly presents as single or two storey, the height and scale of this built form to the street should be retained and the development designed to step down and follow the slope of the land. This will minimise cut and fill and also limit overshadowing and privacy impacts to neighbouring properties.

Attention must also be given to retaining views from the public domain and providing for view sharing from private properties; these can be achieved by providing suitable side boundary setbacks, roof forms and thoughtful distribution of building form across the site.

#### Streetscape character and key elements of the precinct

Development respects and enhances the existing elements of the character that contribute to the precinct including:

- a) the rich mixture of architectural styles;
- b) the stepping of development on the hillside to minimise visual impact and follow the landform;
- c) the significance of heritage items and the adjacent heritage conservation areas of Darling Point Road, Etham Avenue, Mona Road and Loftus Road/Mona Road and individual heritage items;
- d) well established gardens and trees;
- e) remnant estate gardens;
- f) historic stonewalls on private and public land;

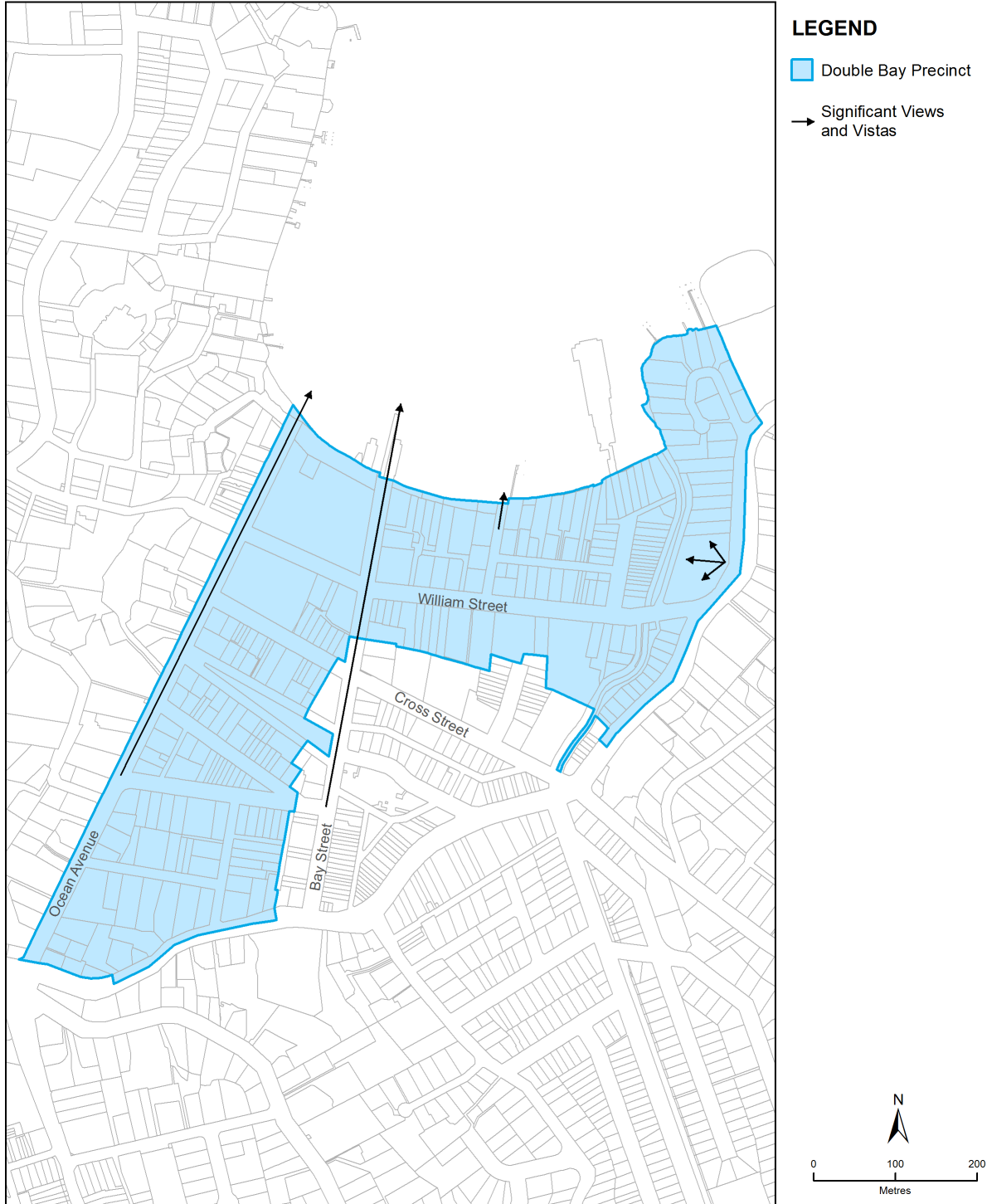
- 
- g) historic stairway and streetscape elements;
  - h) pedestrian links through the precinct;
  - i) mature street trees especially along the ridgeline;
  - j) the highly visible tree canopy providing a dense green backdrop to views from Sydney Harbour and surrounding lands;
  - k) extensive views afforded from the public spaces including corridors between buildings and the preservation of important iconic and harbour views; and
  - l) waterfront reserves and parks.

#### Desired future character objectives

- 01 To respect and enhance the streetscape character and key elements of the precinct.
- 02 To maintain the sense of the historic grand estates.
- 03 To maintain the evolution of residential building styles through the introduction of well designed contemporary buildings incorporating modulation and a varied palette of materials.
- 04 To maintain the heritage significance of heritage items and buildings in adjacent heritage conservation areas.
- 05 To ensure that development does not reproduce or match existing intrusive buildings.
- 06 To ensure that alterations and additions to period buildings, such as semi-detached dwellings and attached dwellings, do not detract from the character of these buildings and their presentation to the street.
- 07 To ensure roof forms are articulated to provide attractive roofscapes and designed to minimise view loss.
- 08 To design and site buildings to respond to the topography and minimise cut and fill.
- 09 To ensure that development is subservient to the tree line along the ridge of Darling Point Road when viewed from the harbour.
- 010 To retain and reinforce the setting of mature street trees and garden plantings especially along the ridgeline by retaining existing trees and providing appropriate replacement planting.
- 011 To retain the landscape setting of the locality by maintaining landscaped areas around buildings and minimising hard stand areas.
- 012 To retain and reinforce the stone and brick retaining walls that characterise the sloping streets of the precinct.
- 013 To protect important iconic and harbour views from public spaces and to provide additional important views from public spaces when possible.

## B1.3 Double Bay Precinct

MAP 3 Double Bay Precinct



---

### B1.3.1 Precinct character statement

---

The Double Bay residential precinct is located to the north and west of the Double Bay centre and includes the Double Bay Public School and 'Steyne Park' between the school and the waterfront. It also includes Council's local history library within Foster Park and a child care centre.

The Double Bay precinct has a strong feeling of community and convenience due to the facilities located within the precinct and the proximity of the adjacent town centre.

The precinct sits within a low lying basin, framing the Double Bay foreshore. The precinct is notable for both the density of its built form and its green landscape character. The tree canopy, formed by both street trees and private plantings, is a prominent element in the municipality's presentation from Sydney Harbour and should be maintained.

The street pattern allows for long views to the harbour, and distant views to surrounding hillsides. Three major streets dominate the precinct: the curvilinear New South Head Road which forms an edge to the precinct to the south; Ocean Avenue, the north-south oriented boulevard that divides Double Bay from the hillside of Darling Point; and the east-west oriented William Street. Due to the topography and location, each of these major streets presents unique settings within the broader common elements of the precinct.

The precinct contains dwelling houses, terraces (attached dwellings) and residential flat buildings, including a number of Inter-War flat buildings that make a significant contribution to the precinct character. The quality of buildings within the precinct represents an evolution and mix of building styles that often maintain a consistent scale across both sides of the street.

### B1.3.2 Desired future character

---

The precinct is an established area comprising many residential flat buildings. Development will generally be in the form of improvements to the existing residential flat buildings.

There are a significant number of Inter-War flat buildings that contribute to the precinct character and are worthy of retention, especially around William Street, New South Head Road and Gladswood Gardens. Alterations and additions to the Inter-War flat buildings are to retain the character of the original building through appropriate use of materials, and should not significantly alter significant and traditional building elements visible from the street.

New development on sites in the R2 Low Density Residential zones along Guilfoyle Street, Cooper Street and the southern side of William Street are to be well-designed and address the street so that development make a positive contribution to the public domain.

On sloping land, new development should step down the site to reinforce the topography and minimise cut and fill. Attention must also be given to protecting views, particularly views from public spaces down Ocean Avenue, Bay and Beach Streets to the harbour, and views from New South Head Road to the harbour.

### Streetscape character and key elements of the precinct

Development respects and enhances the existing elements of the neighbourhood character that contribute to the precinct including:

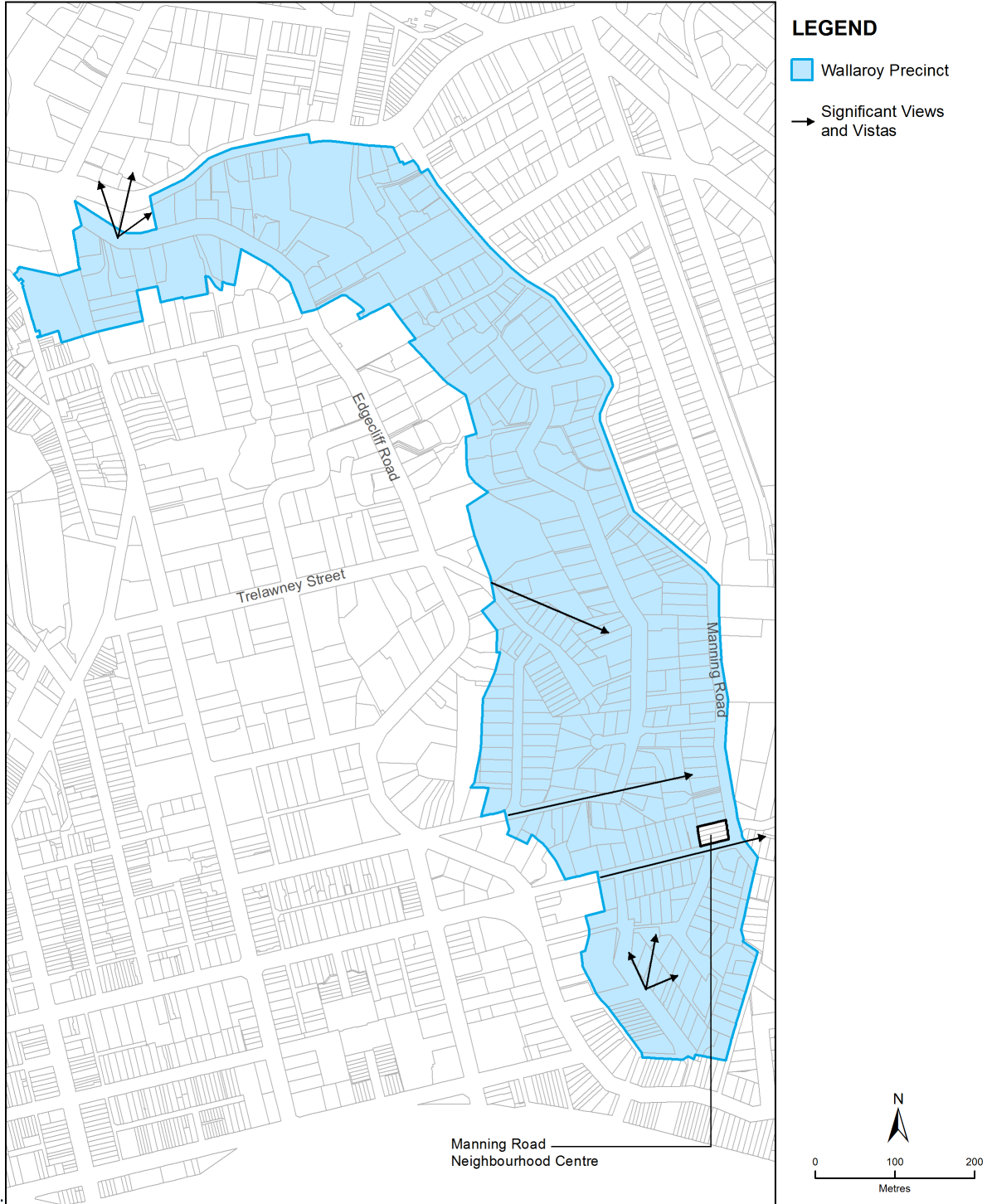
- a) the rich mixture of architectural styles and building forms;
- b) the topography and the siting of development on New South Head Road, which descends into (and ascends out of) the Double Bay centre;
- c) well established gardens and trees including the avenue plantings in Ocean, Guilfoyle and South Avenues, Bay Street and William Street;
- d) the established tree canopy;
- e) the harbour views and view corridors from public places;
- f) the character of Inter-War flat buildings; and
- g) the heritage significance of the adjoining Transvaal Avenue Heritage Conservation Area.

### Desired future character objectives

- 01 To respect and enhance the streetscape character and key elements of the precinct.
- 02 To reinforce a consistent building scale within streets.
- 03 To design and site buildings to respond to the topography and minimise cut and fill.
- 04 To maintain the evolution of residential building styles through the introduction of well designed contemporary buildings, incorporating modulation and a varied palette of materials.
- 05 To ensure that rooflines sit within the predominant street tree canopy.
- 06 To maintain the significance of heritage items within the precinct, and the character of the adjoining Transvaal Avenue Heritage Conservation Area.
- 07 To retain Inter-War flat buildings, particularly significant and traditional building elements visible from the street.
- 08 To provide a transition between the higher density buildings of the Double Bay centre and the lower density buildings of the residential area.
- 09 To retain and reinforce the green setting of mature street trees, private trees and garden plantings.
- 010 To protect important iconic and harbour views from the public spaces.
- 011 To maintain on-street parking and minimise kerb crossings, particularly on Bay Street and Ocean Avenue.

## B1.4 Wallaroy Precinct

MAP 4 Wallaroy Precinct



---

### **B1.4.1 Precinct character statement**

---

The Wallaroy precinct is sited along a ridgeline and hillside overlooking Double Bay and Sydney Harbour. The precinct extends from the valley floor at Manning Road to the main arterial road at New South Head Road and the Woollahra Heritage Conservation Area adjacent to Edgecliff Road.

The steeply sloping topography allows for expansive views from the streets as they wind down the hill from Edgecliff Road.

This is a predominantly low density residential precinct. It contains a mix of mainly one and two storey dwelling houses along Wallaroy Road, the eastern part of Attunga Street, Milton Avenue and the western side of Manning Road. There are some two storey houses with garaging underneath in Manning Road and Linden Avenue, establishing a three storey presentation to the street.

Residential flat buildings are located in the northern part of the precinct towards New South Head Road, and in the western and southern parts of the precinct towards Edgecliff Road and Bondi Junction.

### **B1.4.2 Desired future character**

---

Development is to establish a transition from the large subdivisions and residential flat buildings at New South Head Road and Edgecliff Road to the dwelling houses situated on the slopes.

There is a mix of old and new buildings within this precinct. Alterations and additions to the period houses should retain key elements of the original buildings, including sense of the spacious grounds, setbacks and traditional roof forms, as viewed from the street.

New dwellings may have contemporary designs, but should not detract from adjoining period housing or the predominant character of the streetscape immediately surrounding the site. Particular consideration should be given to establishing consistent front and side setbacks, and providing compatible materials, roof forms and street walls.

On sloping sites, development should step down the site to maintain views, protect the privacy and solar access of adjoining and adjacent properties, and minimise cut and fill.

Residential flat buildings are permitted in the northern part of the precinct up to a height of six storeys. Where these sites adjoin properties with a lower height limit, development is to establish a sympathetic transition to the boundaries; this may be through a graduation of building bulk and height, increased setbacks, or both.

Development adjacent to the Woollahra Heritage Conservation Area must suitably respond to the significance of the HCA.

---

### Streetscape character and key elements of the precinct

Development respects and enhances the existing elements of the neighbourhood character that contribute to the precinct including:

- a) the period housing, including large Federation and Inter-War houses set within spacious grounds;
- b) pitched roof or articulated roof forms;
- c) the stepping of development on the hillside;
- d) well established private gardens and trees;
- e) grassed verges and mature street trees;
- f) sandstone garden walls at the street;
- g) the highly visible tree canopy providing a dense green backdrop to views from Sydney Harbour and surrounding lands;
- h) the preservation of view corridors from public places, including view corridors between buildings; and
- i) Inter-War flat buildings.

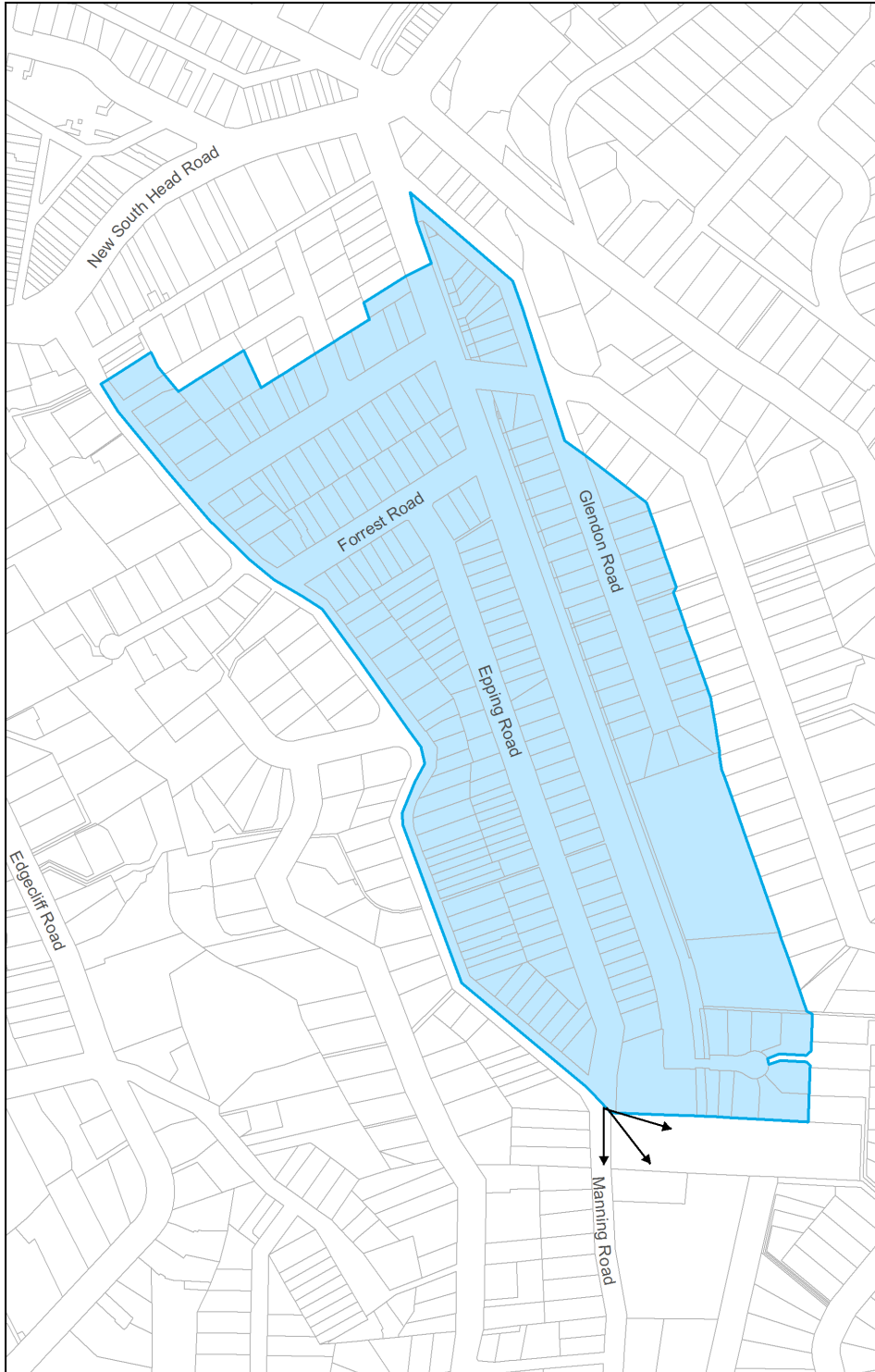
### Desired future character objectives

- 01 To respect and enhance the streetscape character and key elements of the precinct.
- 02 To establish a development transition from the large residential flat buildings and lots at New South Head Road and Edgecliff Road to the smaller dwelling houses situated on the slopes.
- 03 To design and site buildings to respond to the topography and minimise cut and fill.
- 04 To maintain the evolution of residential building styles through the introduction of well designed contemporary buildings, incorporating modulation and a varied palette of materials.
- 05 To protect iconic, harbour and other significant views from the public spaces of the precinct.
- 06 To promote view corridors between buildings to significant views, particularly harbour views.
- 07 To ensure that development on the western boundary of the precinct does not have an adverse impact on the heritage significance of the adjoining Woollahra Heritage Conservation Area.
- 08 To retain and reinforce the green setting of mature street trees, private trees and garden plantings.
- 09 To retain Inter-War flat buildings, particularly significant and traditional building elements visible from the street.





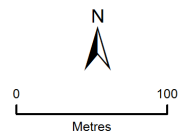
## B1.5 Manning Road Precinct

MAP 5 Manning Road Precinct



### LEGEND

-  Manning Road Precinct Boundary
-  Significant Views and Vistas



---

### B1.5.1 Precinct character description

---

The Manning Road precinct lies at the base of the Double Bay valley. To the south, east and west are residential areas situated on the hillside, and to the north is the Double Bay centre. The planning controls establish a transition area by graduating the intensity of residential development from the Double Bay Centre to the residential areas.

Although the precinct is zoned R3 Medium Density Residential, the historic subdivision pattern of small single lots provides for the dominant building form of dwelling houses and semi-detached dwellings. The exception is Court Road and parts of Manning Road where lot sizes are relatively larger and some residential flat buildings have been developed.

Forrest Road, Glendon Road and parts of Manning Road are characterised by single storey bungalows and semi-detached dwellings, interspersed with two storey contemporary dwellings.

A significant amount of redevelopment has occurred in Epping Road. The development has predominantly taken the form of two storey semi-detached dwellings or dwellings houses with reduced side setbacks, reflecting the narrow frontages of lots along that street.

### B1.5.2 Desired future character

---

The precinct's exceptional characteristic is its landscape quality provided by its location at the base of the valley, the highly visible private gardens and the prominent street tree plantings and grassed verges. Development is to reinforce the landscape character by maintaining a landscape setting.

There is a mix of old and new buildings within this precinct. Development for residential flat buildings is generally occurring in the transition area around Court Road close to the Double Bay Centre. However, this precinct is zoned R3 Medium Density Residential and is identified for change.

Development is to recognise the character of the existing built fabric and other prevailing characteristics in the street, such as front gardens, side setbacks and roof forms. Contemporary designs should respond to the streetscape character or adjoining period housing.

Carports and other parking structures must not to dominate the streetscape, and for development on the eastern side of Epping Road vehicle access will only be allowed from the rear lane.

#### Streetscape character and key elements of the precinct

Development respects and enhances the existing elements of the neighbourhood character that contributes to the precinct including:

- a) the period housing, including modest Federation and Inter-War bungalows in landscape settings;
- b) buildings and roof forms sited beneath the highly visible tree canopy;
- c) regular separation and rhythm of spaces between buildings;
- d) uniform street and rear setbacks incorporating highly visible soft landscaping;

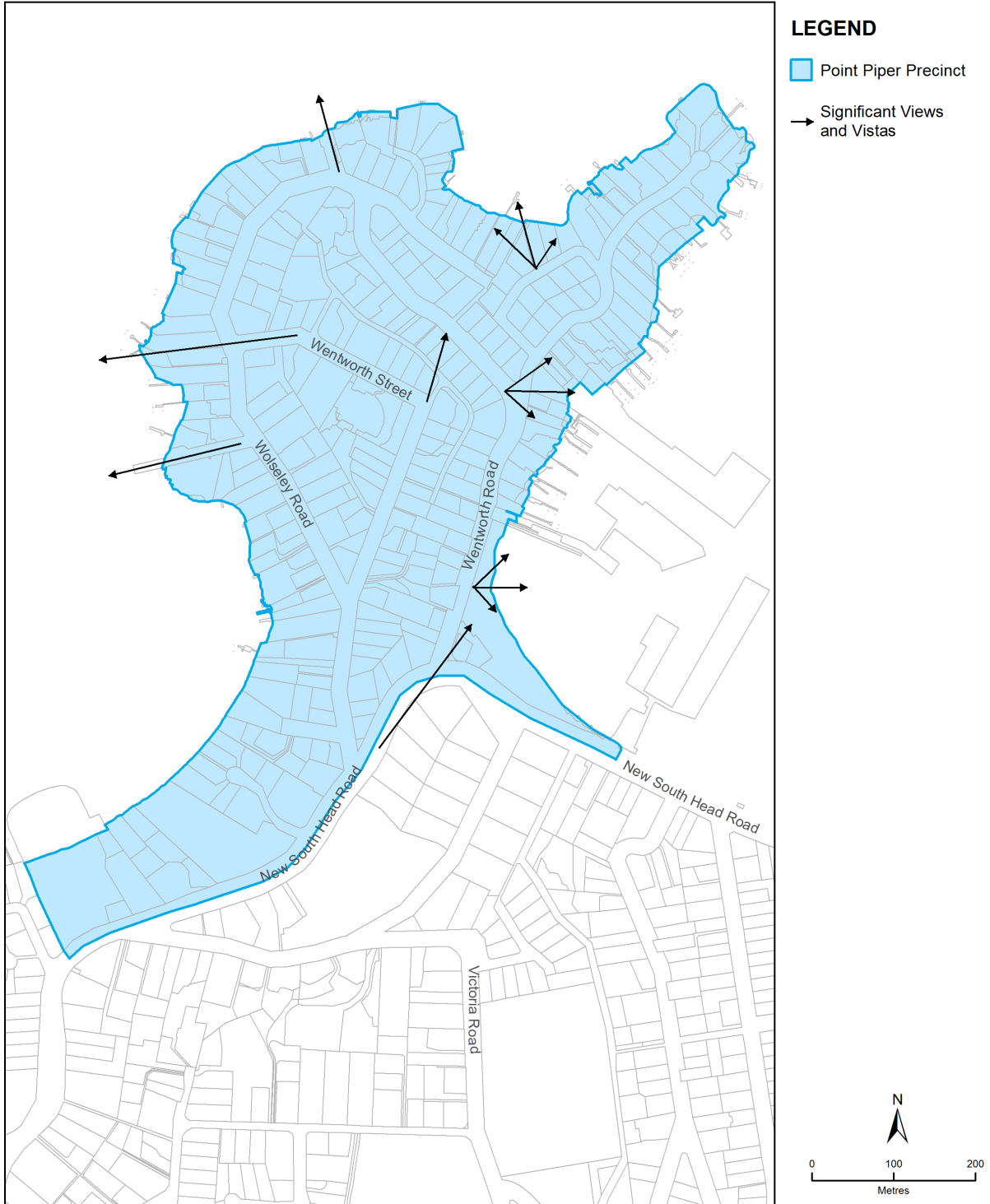
- e) mature street trees and grassed verges; and
- f) the highly visible tree canopy as it appears from the surrounding lands.

#### **Desired future character objectives**

- O1 To respect and enhance the streetscape character and key elements of the precinct.
- O2 To establish a transition between the urban quality of the Double Bay centre and the landscape setting and built form character of the residential precinct.
- O3 To reinforce the landscape character and low scale residential character of the Double Bay valley floor.
- O4 To retain and reinforce the green setting of mature street trees, private trees and garden plantings.
- O5 To ensure on-site parking does not dominate the streetscape.
- O6 To ensure that contemporary housing designs do not detract from the streetscape character or adjoining period housing.

## B1.6 Point Piper Precinct

MAP 6 Point Piper Precinct



---

### B1.6.1 Precinct character statement

---

The Point Piper precinct is a prominent peninsula on Sydney Harbour between Double Bay and Rose Bay. The location provides extensive views across the harbour and surrounding harbourside suburbs.

The precinct contains a range of housing types and styles including an excellent group of Inter-War flat buildings at Longworth Avenue (substantially retained in their garden settings), large post World War II flat buildings at Wolseley Road, and more recent substantial harbourside houses on large lots (including battle-axe lots).

However, the streetscapes within the precinct vary in quality, and often front fences, walls and garages fronting the street block harbour views from the footpath.

### B1.6.2 Desired future character

---

The Point Piper precinct is an established residential area with a mixture of architectural styles and forms. It contains both R2 Low Density and R3 Medium Density Residential zoned land.

In the areas zoned R2, development will generally take the form of dwelling houses set within landscaped garden settings. Development must provide opportunities for view sharing from both public spaces and private properties. In particular, buildings should step down the site, also minimising cut and fill. The design of roofs, garages and fences should also facilitate view sharing opportunities and must not dominate the streetscape.

Development on the low side of the street should also contribute to maintaining a consistent front setback, generally set as a 4 metre setback.

Properties at 10, 12 and 14 Longworth Avenue must establish a single storey presentation to the street and provide for view sharing to surrounding properties.

The western side of the peninsula is predominantly zoned R3 zoning, and development for residential flat buildings and multi dwelling housing is encouraged.

The area between Longworth Avenue and Wunulla Road comprises a number of well maintained Inter-War flat buildings. These buildings make a significant contribution to the streetscape. Alterations and additions to these Inter-War flat buildings are to retain the character of the original building through appropriate use of materials, and should not significantly alter significant and traditional building elements visible from the street.

#### Streetscape character and key elements of the precinct

Development respects and enhances the existing elements of the neighbourhood character that contribute to the precinct including:

- a) the rich mixture of architectural styles and forms;
- b) views and glimpses of the harbour between buildings from public spaces;
- c) the stepping of development down the hillside;

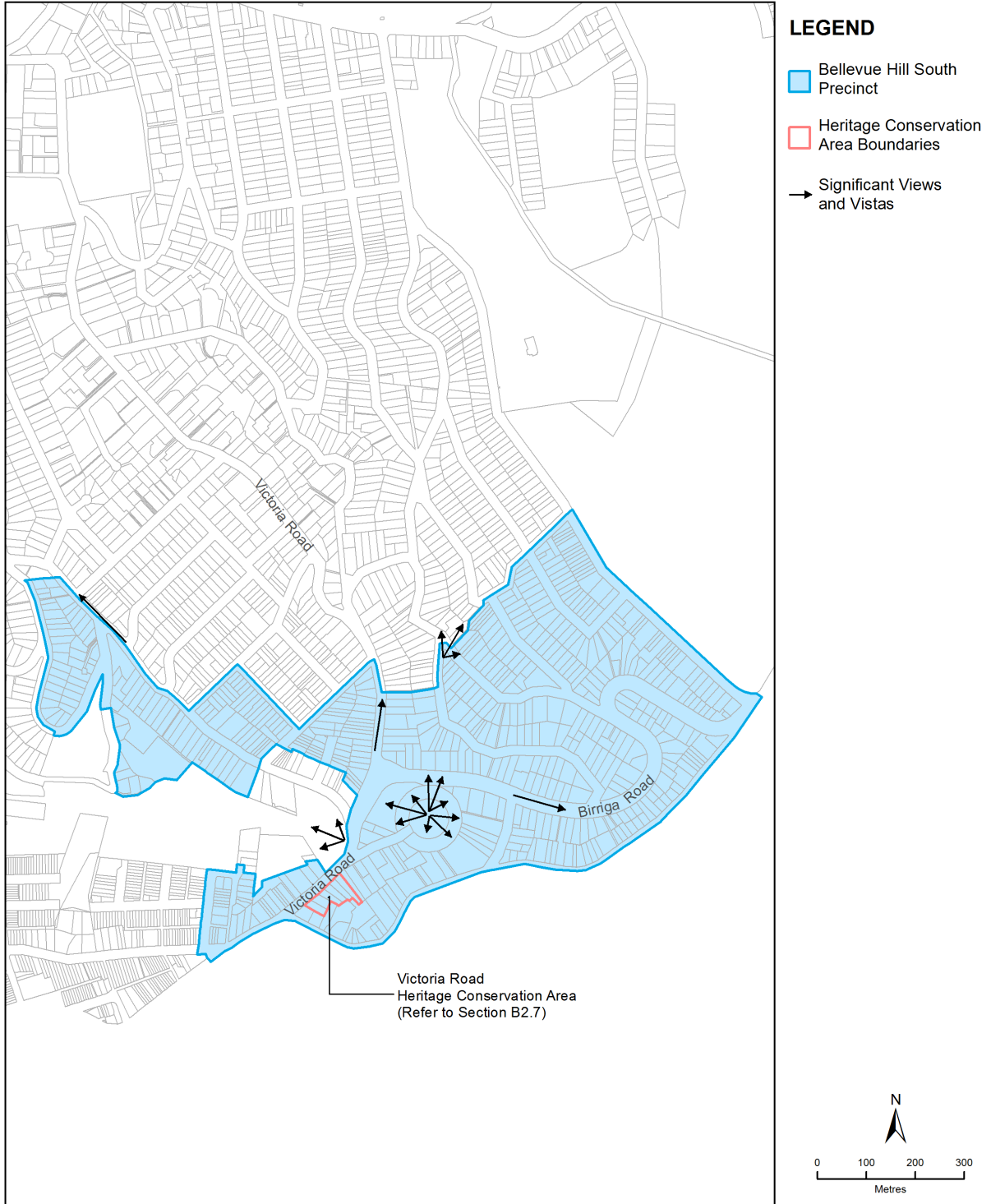
- 
- d) well established private gardens and trees;
  - e) mature street trees;
  - f) stone and brick retaining walls on public and private land; and
  - g) Inter-War flat buildings.

#### Desired future character objectives

- 01 To respect and enhance the streetscape character and key elements of the precinct.
- 02 To maintain the evolution of residential building styles through the introduction of well designed contemporary buildings, incorporating modulation and a varied palette of materials.
- 03 To ensure that development on the low side of the street maintains a consistent front setback.
- 04 To design and site buildings to respond to the topography and minimise cut and fill.
- 05 To protect iconic and harbour views from the street and other public spaces in the precinct, including views between buildings and over or through front fences.
- 06 To ensure that development facilitates view sharing to adjoining and adjacent private properties.
- 07 To maintain the sense of the historic grand estates by retaining the garden settings and streetscape elements.
- 08 To retain Inter-War flat buildings, particularly significant and traditional building elements visible from the street.
- 09 To retain and reinforce the stone and brick retaining walls that characterise the sloping streets of the precinct.

## B1.7 Bellevue Hill South Precinct

MAP 7 Bellevue Hill South Precinct



---

### B1.7.1 Precinct character statement

---

The Bellevue Hill South precinct is sited along the ridgeline and plateau of Bellevue Hill. The precinct contains a wide range of housing types and styles. As with many of the residential areas across the municipality, the built fabric is set within a landscaped setting.

Land within this precinct is zoned R3 Medium Density Residential, but the form and scale of buildings vary from the Inter-War flat buildings and more recent flat buildings to low density dwelling houses and semi-detached dwellings.

The street pattern in this part of Bellevue Hill responds to the nature of the landform, curvilinear in hillside areas, and rectilinear in flat areas. Distant views to the city skyline and the harbour are available from some parts of the precinct.

The precinct contains a number of street types in an identifiable hierarchy, and the precinct is generally divided into two sections based on the road hierarchy.

The main roads include Birriga Road, Old South Head Road, Victoria Road and Bellevue Road. Development along these roads is characterised by Inter-War and contemporary residential flat buildings, interspersed with semi-detached and detached dwelling houses. The housing stock includes original dwellings from the early 20th century and Inter-War period with more substantial contemporary dwelling houses.

Development along the local roads contains a mix of dwelling houses, semi-detached houses, multi-dwelling housing and residential flat buildings. Development on the sloping sites steps down the hillside. The precinct contains a diverse mix of building styles from early 20th century buildings to well-designed contemporary buildings.

The precinct also incorporates, or is adjacent to, significant public parklands and open spaces. The upper part of Cooper Park, the Woollahra Golf Course and Bellevue Park all contribute to the identity of the precinct.

### B1.7.2 Desired future character

---

New development on the major streets of Birriga Road, Victoria Road and Old South Head Road will generally take the form of residential flat buildings and multi dwelling housing, and maintenance of existing Inter-War flat buildings. New development should be designed to step down sloping sites and provide side boundary setbacks that allow for views between buildings. Development should not detract from the amenity of adjoining and adjacent lower density forms of residential development.

Development along the local roads will provide a mix of housing densities and styles in well designed contemporary buildings, which reinforce the natural topography and provide opportunities for view sharing. This may include multi-dwelling housing, attached dwellings and dwelling houses in the transition area at Boronia Street, Blaxland Road and the northern side of Bundarra Road, and semi-detached dwellings, as well as dwelling houses, in Pringle Place and Buller Street.



Development must provide opportunities for view sharing from both public spaces and private properties. In particular, buildings should step down the site, also minimising cut and fill.

### Streetscape character and key elements of the precinct

Development respects and enhances the existing elements of the neighbourhood character that contribute to the precinct including:

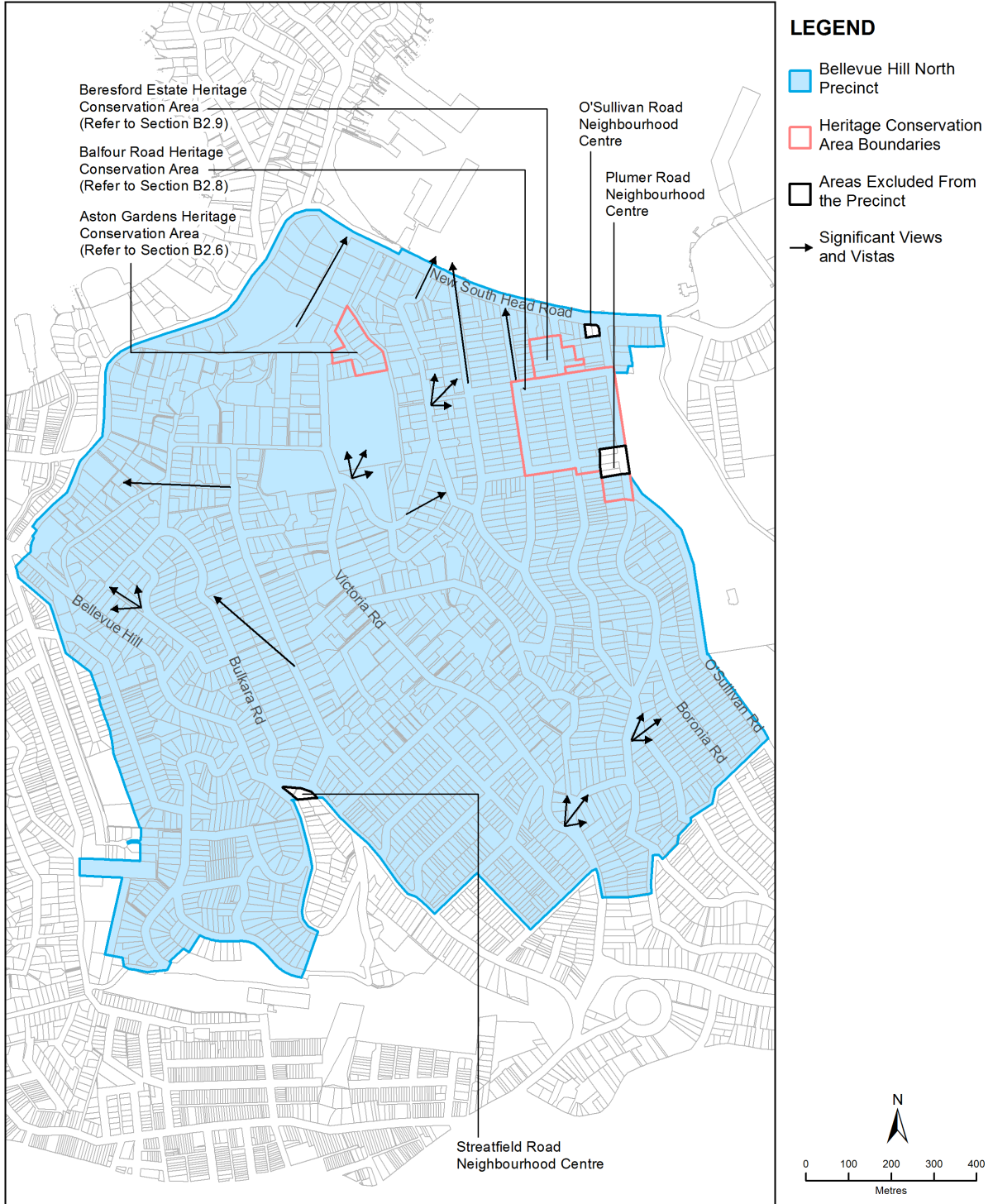
- a) the rich mixture of architectural styles and forms;
- b) the stepping of development down the hillside;
- c) interconnected streets following the contours of the land;
- d) deep soil landscaping within the front and rear setbacks;
- e) mature street trees and grassed verges;
- f) the highly visible tree canopy providing a dense green backdrop to views from Sydney Harbour and surrounding lands;
- g) the preservation of views from public places, including view corridors between buildings; and
- h) Inter-War flat buildings.

### Desired future character objectives

- O1 To respect and enhance the streetscape character and key elements of the precinct.
- O2 To maintain the evolution of residential building styles through the introduction of well designed contemporary buildings, incorporating modulation and a varied palette of materials.
- O3 To establish a transition of development scale from the detached dwelling houses at the northern end of Bellevue Hill to the residential flat buildings that address the major streets - Birriga Road, Old South Head Road and Victoria Road - situated along the precinct ridgeline.
- O4 To retain Inter-War flat buildings and ensure that alterations and additions do not detract from the character of these buildings and their presentation to the street.
- O5 To design and site buildings to respond to the topography and minimise cut and fill.
- O6 To preserve significant views and vistas to surrounding areas from the streets and parks.
- O7 To reinforce the landscape setting and maintain the existing tree canopy.

# B1.8 Bellevue Hill North Precinct

## MAP 8 Bellevue Hill North Precinct



---

### B1.8.1 Precinct character statement

---

The Bellevue Hill North precinct is sited on the slopes and plateau of Bellevue Hill. New South Head Road, the main arterial road, forms the northern edge of the precinct.

The precinct contains three distinct settings:

- ▶ the edge development fronting New South Head Road (between Bellevue Road and Victoria Road) which contains predominantly substantial residential flat buildings set behind sandstone walls, garages and steps;
- ▶ development opposite the Rose Bay promenade on New South Head Road, typically large detached buildings within a landscape setting; and
- ▶ the one to three storey dwelling houses and residential flat buildings set in the winding streets that follow the contours of Bellevue Hill.

As with many of the higher parts of the municipality, significant views and vistas are available from many of the public spaces. This precinct also contains two large private school campuses: Cranbrook School and Scots College.

---

### B1.8.2 Desired future character

---

The Bellevue Hill North precinct is an established residential area with a rich mixture of architectural styles and forms. Development is to be compatible with the existing built fabric, subdivision pattern and other prevailing characteristics in the street, such as setbacks and roof forms.

On sloping sites, development should step down the site to maintain views, protect the privacy and solar access of adjoining and adjacent properties, and minimise cut and fill. The design of roofs and fences should also facilitate view sharing opportunities, and carports and other parking structures must not to dominate the streetscape.

There are pockets of Inter-War flat buildings along Drumalbyn Road that contribute to the precinct character, and the retention of these buildings is encouraged. Alterations and additions to the Inter-War flat buildings are to retain the character of the original building through appropriate use of materials, and should not significantly alter significant and traditional building elements visible from the street.

Development is to retain views of the harbour from public spaces and provide for view sharing from private properties. Development adjacent to the heritage conservation areas must also suitably respond to the significance of the HCA.

---

### Streetscape character and key elements of the precinct

Development respects and enhances the existing elements of the neighbourhood character that contribute to the precinct including:

- a) the rich mixture of residential architectural styles and forms, including dwelling houses and residential flat buildings;
- b) the relationship of development along New South Head Road to the promenade and the harbour;
- c) buildings set within highly visible gardens;
- d) the tree canopy formed by both street and private yard plantings;
- e) mature street trees, grassed verges and sandstone walls;
- f) harbour views available from the streets within the precinct;
- g) the heritage significance of the adjoining Aston Gardens, Beresford Estate and Balfour Road Heritage Conservation Areas; and
- h) Inter-War flat buildings.

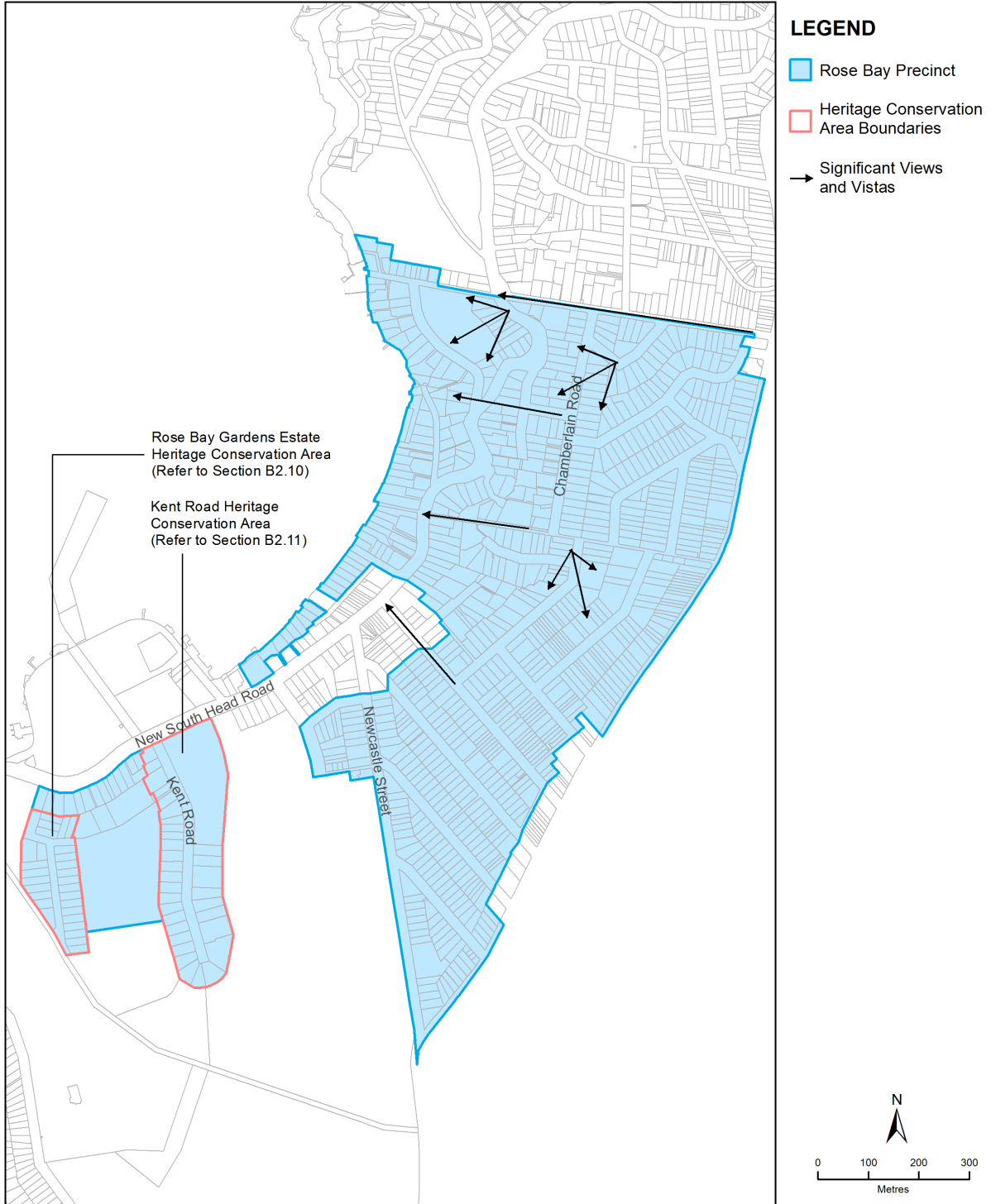
### Desired future character objectives

- 01 To respect and enhance the streetscape character and key elements of the precinct.
- 02 To maintain the evolution of residential building styles through the introduction of well designed contemporary buildings incorporating modulation and a varied palette of materials.
- 03 To maintain a transition of development scale from the residential flat buildings that address New South Head Road, to the dwelling houses that dominate the majority of the precinct.
- 04 To reinforce a consistent building scale with streets.
- 05 To ensure that development responds in form and siting to the street and subdivision pattern.
- 06 To design and site buildings to respond to the topography and minimise cut and fill.
- 07 To reinforce the landscape setting and maintain the existing tree canopy which forms a green backdrop when viewed from the harbour and the surrounding districts.
- 08 To retain and reinforce the green setting of mature street trees, private trees and garden plantings and minimise hard stand areas.

- 09 To protect important views from the public spaces of the precinct to the harbour and city skyline, including view corridors between buildings.
- 010 To ensure that development facilitates view sharing to adjoining and adjacent private properties.
- 011 To ensure on-site parking does not dominate the streetscape.
- 012 To retain Inter-War flat buildings, particularly significant and traditional building elements visible from the street.

## B1.9 Rose Bay Precinct

MAP 9 Rose Bay Precinct



---

### B1.9.1 Precinct character statement

---

The Rose Bay residential precinct incorporates the hillside at the neck of the eastern suburbs peninsula and the lowest part of the Rose Bay basin (adjacent to the large park and recreational area). The street block system in the low lying areas is generally rectilinear, allowing for regular building lots. On the hillsides, irregular street and block patterns occur reflecting the topography.

Prominent building types within the precinct include Inter-War detached housing and Art Deco flat buildings. More recent development, particularly in Spencer and Carlisle Streets, has seen the subdivision pattern altered to create larger lots for residential flat buildings.

The Rose Bay residential precinct is sited between the two main urban connectors of Old South Head Road and New South Head Road. The Rose Bay Centre is located on New South Head Road in the western part of the precinct. The mixed use centres of Rose Bay North and Rose Bay South are located on Old South Head Road. These centres frame the precinct and serve the daily and weekly shopping needs of the local community.

This precinct also includes the Kambala School, Lyne Park and the Royal Sydney Golf Club.

---

### B1.9.2 Desired future character

---

This precinct includes land zoned R2 Low Density Residential and R3 Medium Density Residential. Most of the R3 Medium Density Residential land is located near the business centres and the main connector roads. Although much of this R3 zoned land currently contains many dwelling houses, this area is identified for change and will be redeveloped for medium density residential uses such as residential flat buildings, manor houses, multi dwelling housing, multi dwelling housing (terraces) and attached dwellings.

In particular, there is opportunity for redevelopment along Old South Head Road, with a view to providing a greater intensity of development adjacent to this classified road.

The residential areas zoned R2 Low Density Residential will continue to experience an evolution of residential building styles through the introduction of well-designed contemporary dwelling houses, which reinforce the natural topography and provide opportunities for view sharing.

On the hillsides and steeply sloping sites, the built form should step with the land to ensure development reflects the existing topography and minimises the need for excavation.

#### Streetscape character and key elements of the precinct

Development respects and enhances the existing elements of the neighbourhood character that contribute to the precinct including:

- a) the rich mixture of residential architectural styles and forms, including dwelling houses and residential flat buildings;
- b) the pattern of rectilinear residential streets within the valley basin, and curvilinear streets in the steeper areas;

- 
- c) dwelling houses set within highly visible gardens;
  - d) the visual relief within streetscapes provided by the separation of buildings, the articulation of facades and building forms;
  - e) the tree canopy formed by both street and private yard plantings;
  - f) sandstone garden walls at the street;
  - g) the relationship of residential development to the open spaces (including Lyne Park and the Royal Sydney Golf Club) and the harbour;
  - h) the iconic and harbour views available from the streets and other public spaces, including view corridors between buildings; and
  - i) Inter-War flat buildings.

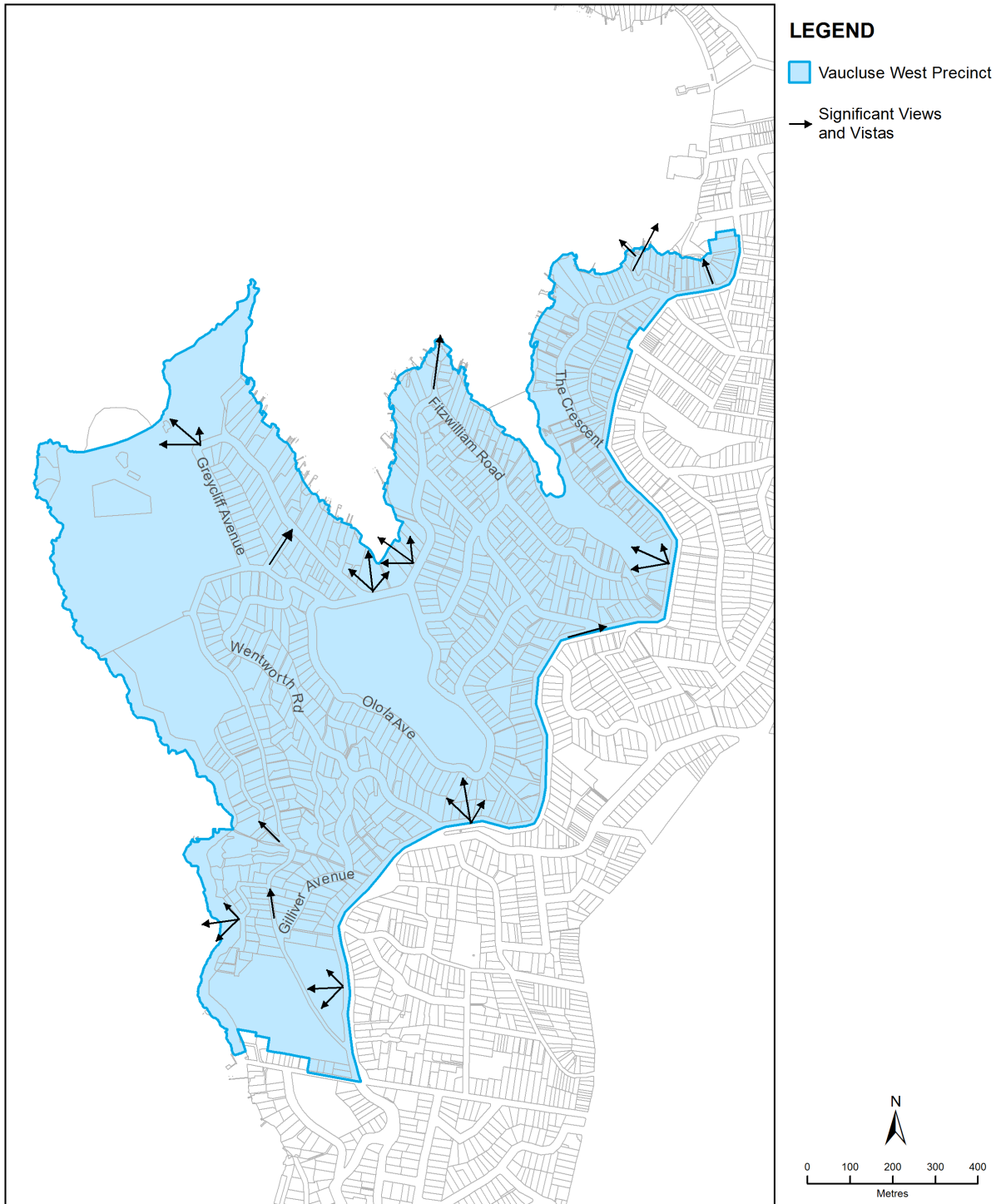
#### Desired future character objectives

- 01 To respect and enhance the streetscape character and key elements of the precinct.
- 02 To encourage development at a scale which relates to the function and role of the streets they address, i.e. larger scale development on the major streets (Old South Head Road and New South Head Road adjacent to the commercial centre) and a range of housing types on the minor streets.
- 03 To provide for an evolution of building stock from dwelling houses to medium density development in the R3 zoned areas.
- 04 To maintain the evolution of residential building styles through the introduction of well designed contemporary buildings incorporating modulation and a varied palette of materials.
- 05 To reinforce a consistent building scale within streets.
- 06 To design and site buildings to respond to the topography and minimise cut and fill.
- 07 To protect important iconic and harbour views from the public spaces of the precinct.
- 08 To reinforce the landscape setting and maintain the existing tree canopy.
- 09 To retain Inter-War flat buildings, particularly significant and traditional building elements visible from the street.



## B1.10 Vaucluse West Precinct

MAP 10 Vaucluse West Precinct



---

### B1.10.1 Precinct character statement

---

The Vaucluse West precinct is sited along the foothills of the harbour foreshore between Rose Bay and Watsons Bay. The precinct is one of outstanding natural beauty and includes foreshore waterfront reserves and waterfront parks, including Nielson Park and Parsley Bay, as well as two large park-like estates: Strickland House and Vaucluse House. The precinct also contains the heritage listed Kincoppal School.

It is a low density residential precinct characterised by large dwelling houses. Though the architectural styles and forms vary, these dwelling houses are generally located within a garden setting and have common street setbacks and side setbacks that allow for views between buildings. Recent development has tended to take the form of three storey dwelling houses with flat roof designs.

The landform, street trees, domestic gardens and substantial foreshore parklands create a dominant visual impression of a well treed landscape. The location adjacent to the harbour also provides for water and parkland views from the streets.

#### Streetscape character and key elements of the precinct

Development respects and enhances the existing elements of the neighbourhood character that contribute to the precinct including:

- a) the relationship of the precinct to the harbour;
- b) the rich mixture of architectural styles, and the emphasis on their connection to the landform;
- c) buildings set within highly visible gardens;
- d) buildings addressing the street; and
- e) the harbour and iconic views available from the streets of the precinct, including view corridors between buildings.

---

### B1.10.2 Desired future character

---

The Vaucluse West precinct is to maintain the evolution of low density residential development through the introduction of well-designed contemporary dwelling houses that retain views of the harbour from public spaces and provide for view sharing from private properties.

Development may be three storeys, but should establish a two storey presentation to the street with a reduced scale on the third floor, which will help reduce building bulk and scale.

On sloping sites, development should step down the site to maintain views, protect the privacy and solar access of adjoining and adjacent properties, and minimise cut and fill.

In particular, development is to retain views of the harbour from public spaces and provide for view sharing from private properties; these can be achieved by providing suitable side boundary setbacks and fencing, roof forms and thoughtful distribution of building form across the site.

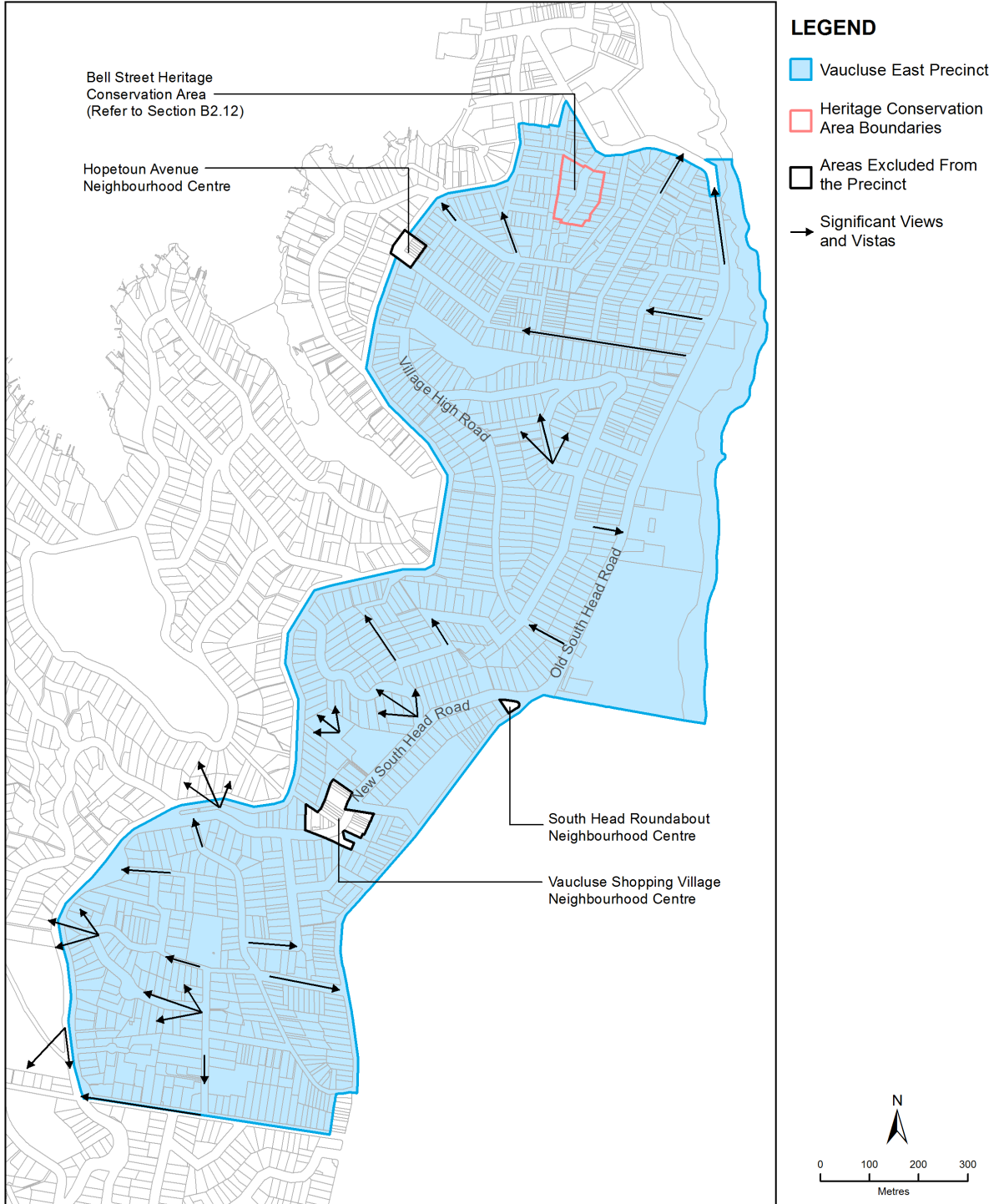
The built form should not detract from the unique features of the natural landscape, or be of such a scale that it dominates adjoining development, or is visually intrusive when viewed from the streetscape or the harbour.

#### Desired future character objectives

- 01 To respect and enhance the streetscape character and key elements of the precinct.
- 02 To retain the scenic qualities provided by the dramatic topography and natural vegetation that provide an attractive setting on Sydney Harbour.
- 03 To maintain the evolution of residential building styles through the introduction of good contemporary buildings incorporating modulation and a varied palette of materials.
- 04 To minimise building bulk and scale of three storey development by designing development to generally present as a two storey form to the street.
- 05 To design and site buildings to respond to the topography and minimise cut and fill.
- 06 To protect important views from the public spaces of the precinct to the harbour and the city skyline including view corridors between buildings.
- 07 To reinforce the landscape setting and maintain the existing tree canopy.
- 08 To retain and reinforce the green setting of mature street trees, private trees and garden plantings.

## B1.11 Vaucluse East Precinct

MAP 11 Vaucluse East Precinct



---

### B1.11.1 Precinct character statement

---

The Vaucluse East Precinct comprises an elevated plateau which provides an extensive backdrop and significant scenic presentation to Sydney Harbour along its eastern foreshore.

A spectacular feature of the precinct is the public foreshore land on the eastern side of Old South Head Road which contains the Macquarie Lighthouse, a prominent harbour landmark and parkland. The highest parts of the precinct afford 360° views of both the harbour and ocean. Vantage points include Johnsons Lookout, Samuel Park, Gap Park, Christison Park and Lighthouse Reserve.

The precinct contains a wide range of housing types and styles reflecting important stages in its development. Large areas are characterised by Federation and Inter-War bungalows. Inter-War residential flat buildings are also important contributors to the local character. However, the dominant development type is the dwelling house, located within a garden setting and highlighted by consistent street setbacks and side setbacks that allow for views between buildings.

The precinct's exposed location at the plateau of the peninsula has resulted in a sparser foliage and tree canopy compared with the more protected streets of the Vaucluse West precinct.

### B1.11.2 Desired future character

---

The Vaucluse East precinct is to maintain the evolution of low density residential development, generally through the introduction of well-designed contemporary dwelling houses.

Development may be three storeys, but should establish a two storey presentation to the street with a reduced scale on the third floor, which will help reduce building bulk and scale.

On sloping sites, development should step down the site to maintain views, protect the privacy and solar access of adjoining and adjacent properties, and minimise cut and fill.

The built form should not detract from the unique features of the natural landscape, or be of such a scale that it dominates adjoining development, or is visually intrusive when viewed from the streetscape or the harbour.

In particular development is to retain views of the harbour from public spaces and provide for view sharing from private properties; these can be achieved by providing suitable side boundary setbacks and fencing, roof forms and thoughtful distribution of building form across the site.

Within this precinct, some land fronting Old South Head Road is zoned R3 Medium Density Residential, and may provide opportunities for renewal of existing building stock.

---

### Streetscape character and key elements of the precinct

Development respects and enhances the existing elements of the neighbourhood character that contribute to the precinct including:

- a) the relationship of the precinct to the coastal parklands;
- b) the rich mixture of architectural styles, and their emphasis on their connection to the landform;
- c) buildings set within highly visible gardens;
- d) buildings addressing the street;
- e) the iconic and harbour views available from the streets of the precinct, including view corridors between buildings; and
- f) Inter-War flat buildings.

### Desired future character objectives

- 01 To respect and enhance the streetscape character and key elements of the precinct.
- 02 To retain the scenic qualities provided by the dramatic topography and natural vegetation within the precinct.
- 03 To maintain the evolution of low rise residential building styles through the introduction of good contemporary buildings incorporating modulation and a varied palette of materials.
- 04 To minimise building bulk and scale of three storey development by designing development to generally present as a two storey form to the street.
- 05 To design and site buildings to respond to the topography and minimise cut and fill.
- 06 To protect important views from the public spaces of the precinct to the harbour and the city skyline, including view corridors between buildings.
- 07 To reinforce the landscape setting and maintain the existing tree canopy.
- 08 To retain and reinforce the green setting of mature street trees, private trees and garden plantings.
- 09 To retain Inter-War flat buildings, particularly significant and traditional building elements visible from the street.

# Chapter B2 Neighbourhood HCAs

Part B ► General Residential

CHAPTER B2 APPROVED ON 27 APRIL 2015

AND COMMENCED ON 23 MAY 2015

Last amended on 22 December 2023

# Chapter B2 ► Neighbourhood HCAs

## Contents

- B2.1 INTRODUCTION ..... 1**
  - B2.1.1 Land where this chapter applies ..... 1
  - B2.1.2 Development to which this chapter applies ..... 3
  - B2.1.3 Objectives ..... 3
  - B2.1.4 Relationship to other parts of the DCP ..... 4
  - B2.1.5 How to use this chapter ..... 4
  - B2.1.6 Definitions ..... 5
  - B2.1.7 General Development Controls ..... 6
- B2.2 ETHAM AVENUE, DARLING POINT ..... 12**
- B2.3 DARLING POINT ROAD, DARLING POINT ..... 15**
- B2.4 MONA ROAD, DARLING POINT ..... 18**
- B2.5 LOFTUS ROAD AND MONA ROAD, DARLING POINT ..... 21**
- B2.6 ASTON GARDENS, BELLEVUE HILL ..... 23**
- B2.7 VICTORIA ROAD, BELLEVUE HILL ..... 25**
- B2.8 BALFOUR ROAD, ROSE BAY/BELLEVUE HILL ..... 27**
- B2.9 BERESFORD ESTATE, ROSE BAY ..... 32**
- B2.10 ROSE BAY GARDENS ESTATE, ROSE BAY ..... 34**
- B2.11 KENT ROAD, ROSE BAY ..... 37**
- B2.12 BELL STREET, VAUCLUSE ..... 40**







## B2.1 Introduction

This is Chapter B2 of the Woollahra Development Control Plan 2015 (DCP), Part B General Residential.

This chapter contains controls for 11 heritage conservation areas (HCAs), referred to as “neighbourhood HCAs” to distinguish these areas from the larger HCAs of Paddington, Woollahra and Watsons Bay.

These neighbourhood HCAs are identified in Schedule 5 of Woollahra Local Environmental Plan 2014 (Woollahra LEP 2014). These groups of buildings are recognised as having heritage significance based on their aesthetic, historic, scientific and/or social values and they make a significant contribution to Woollahra’s rich heritage. Some of the individual buildings and sites within these HCAs are also heritage items, whilst others are contributory items due to the positive contribution they make to the HCA.

These are areas in which the cultural significance and relationships between the various characteristics creates a sense of place that is worth conserving. The cultural significance is embodied in the subdivision pattern, building materials, styles, forms, details and arrangements of the heritage items, buildings and streetscape elements of the HCAs. Together these elements create a shared history, historic character, sense of place, and shared aesthetic or visual presence that has been identified as of particular value to the community.

These HCAs have been identified following studies and assessments by Council, including documentary investigation and fieldwork surveys. Specific elements of significance are identified in each HCA. The periods and styles of the buildings within the neighbourhood HCAs include Late Victorian cottages, Federation Arts and Crafts dwellings, Federation Queen Anne dwellings, Federation Bungalows, Inter-War dwellings and Inter-War flat buildings in the Art Deco, Spanish Mission, Georgian Revival and Functionalist styles.

### B2.1.1 Land where this chapter applies

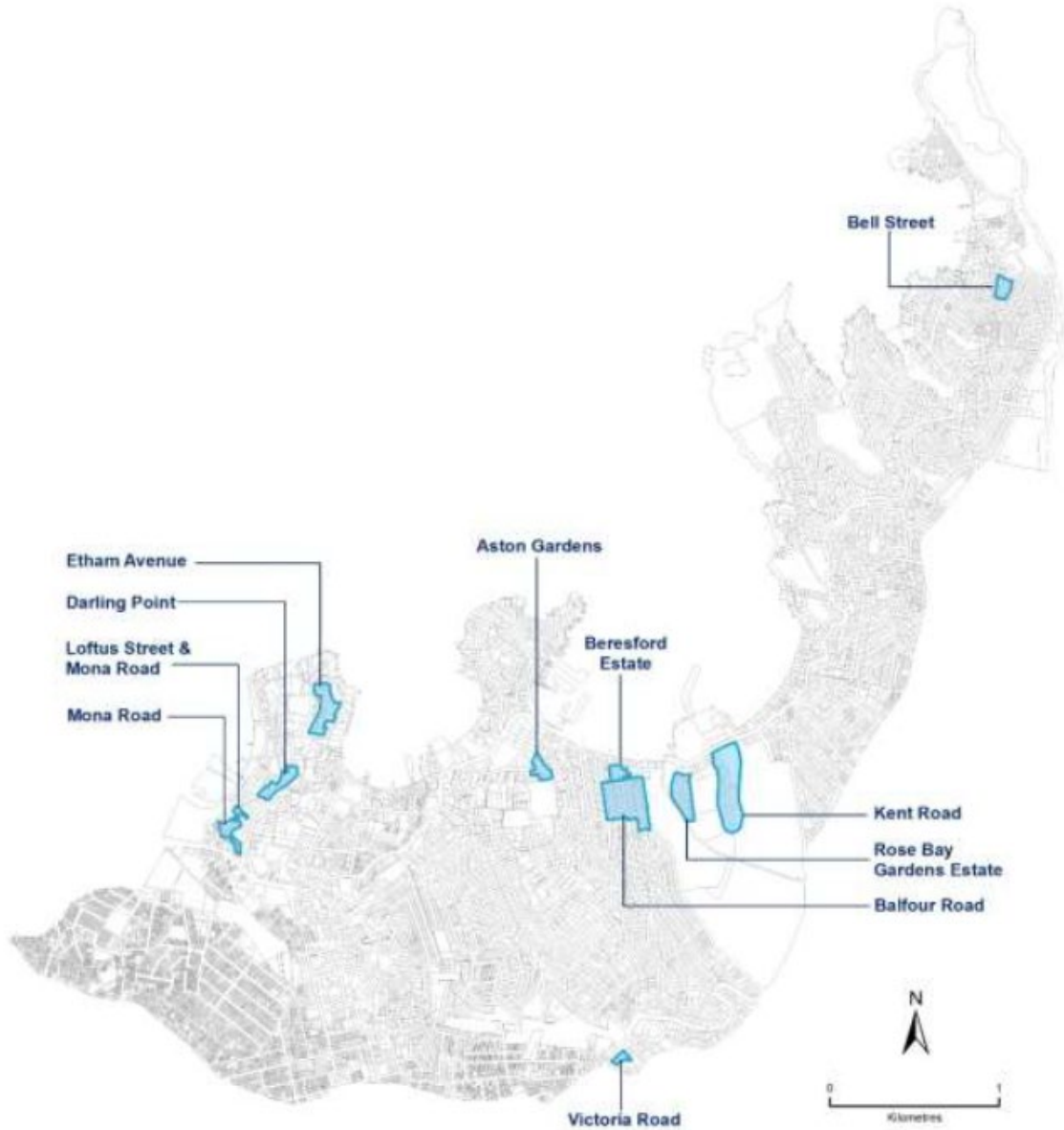
---

This chapter applies to the following neighbourhood HCAs:

- ▶ Etham Avenue, Darling Point
- ▶ Darling Point Road, Darling Point
- ▶ Mona Road, Darling Point
- ▶ Loftus Road and Mona Road, Darling Point
- ▶ Aston Gardens, Bellevue Hill
- ▶ Victoria Road, Bellevue Hill
- ▶ Balfour Road, Rose Bay
- ▶ Beresford Estate, Rose Bay
- ▶ Rose Bay Gardens Estate, Rose Bay
- ▶ Kent Road, Rose Bay
- ▶ Bell Street, Vaucluse

These neighbourhood HCAs are identified on the map below. A separate map of each HCA is also provided in the relevant sections of this chapter.

**MAP 1** Map of the Neighbourhood HCAs in the Woollahra local government area



---

### B2.1.2 Development to which this chapter applies

---

This chapter applies to development that requires development consent.

Generally this will be residential development, but may include other permitted uses such as child care centres, community facilities, educational establishments, neighbourhood shops and places of public worship, and other uses permitted in Woollahra LEP 2014.

### B2.1.3 Objectives

---

The objectives of this chapter are:

- 01 To retain the cultural or heritage significance of the HCAs, including their cohesive character and distinctive historic features.
- 02 To retain and promote evidence of the historical development and cultural significance of the neighbourhood HCAs and enable the interpretation of that development.
- 03 To encourage the ongoing conservation of heritage items and the significant elements of contributory items.
- 04 To ensure that development is sympathetic to the heritage significance of buildings, their settings, the streetscape and the broader HCA.
- 05 To ensure that development is compatible with the significant characteristics of the neighbourhood HCAs and respects the principles contained in the Australia ICOMOS *Charter for the Conservation of Places of Cultural Significance* (the Burra Charter).

This chapter seeks to ensure that development has regard to the heritage significance of the area and is compatible with the desired future character for the neighbourhood HCA. The objectives in this chapter apply in addition to the objectives in Chapter B3 General Development Controls.

Note: The term ‘original’ as used throughout the DCP refers to any significant fabric. This may be from a range of historic periods.

#### Conservation philosophy

This chapter of the DCP adopts the conservation philosophy embodied in the Australia ICOMOS Charter for the Conservation of Places of Cultural Significance (the Burra Charter).

The Burra Charter is widely accepted by Government Agencies and private industry as the standard philosophy for heritage conservation practice in Australia. The Charter sets down principles, processes and practices for the conservation of significant places.

Demolition of significant fabric within HCAs is contrary to the Woollahra LEP 2014, the Woollahra DCP 2015 and the Burra Charter. Whilst heritage listing does not preclude sensitive change, conservation and restoration of significant fabric is a priority. Demolition should be a last resort where buildings cannot be reasonably retained and conserved, in accordance with the Helou v Strathfield planning principle.

---

Further information can be found in Council's DA Guide Demolition report when considering demolition within a HCA.

### B2.1.4 Relationship to other parts of the DCP

---

This chapter is to be read in conjunction with the other parts of the DCP that are relevant to the development proposal, including:

- ▶ Chapter B1 Residential precincts.
- ▶ Chapter B3 General Development Controls.
- ▶ Part E: General Controls for All Development - this part contains chapters on Parking and Access, Stormwater and Flood Risk Management, Tree Management, Contaminated Land, Waste Management, Sustainability, Signage and Adaptable Housing.
- ▶ Part F: Land Use Specific Controls - this part contains chapters on Child Care Centres, Educational Establishments, Licensed Premises and Telecommunications.

### B2.1.5 How to use this chapter

---

The primary controls for the neighbourhood HCAs are set out in three chapters:

- ▶ Chapter B1 Residential Precincts;
- ▶ Chapter B2 Neighbourhood HCAs; and
- ▶ Chapter B3 General Development Controls.

#### Chapter B1 Residential Precincts

Each neighbourhood HCA is part of a residential precinct with its own character and desired future character as detailed in Chapter B1.

Applicants need to demonstrate how their development fulfills the relevant objectives having particular regard to the provisions in B1.

The provisions in B1 supplement B2. Unless otherwise indicated, where there is an inconsistency between the objectives and controls in Chapters B1 and B2, the HCA specific objectives and controls in B2 take precedence over the general controls.

#### Chapter B2 Neighbourhood HCAs

Each section in this chapter represents an HCA. Applicants only need to refer to the particular area that is relevant to their site.

The controls for each HCA comprise the following elements:

- ▶ map showing the extent of the HCA;
  - ▶ statement of significance identifying significant characteristics and architectural character of the HCA;
-

- ▶ desired future character for each HCA. Applicants need to demonstrate how their development fulfills the relevant objectives having particular regard to the objectives and controls at B2.1.3 and B2.1.7; and
- ▶ list of contributory items for each HCA.

Note: refer also to clause 5.10 of the Woollahra LEP 2014 when assessing impacts to heritage items and heritage conservation areas.

### Chapter B3 General Development Controls

The general controls in Chapter B3 apply to all land where Chapter B2 applies.

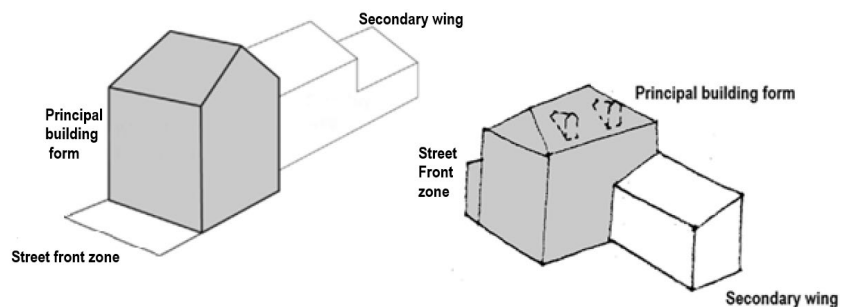
Development is required to fulfil the relevant requirements of all the general controls. Unless otherwise indicated, where there is a disparity between the objectives and controls in Chapters B2 and B3, the HCA specific objectives and controls in this chapter take precedence over the general controls.

## B2.1.6 Definitions

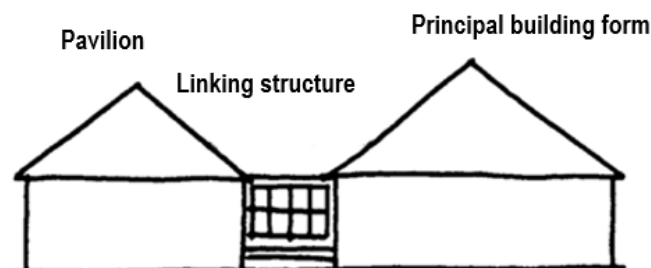
The definitions below define words and expressions for the purpose of this chapter.

These definitions apply in addition to the definitions in Part A Chapter A3 of the Woollahra DCP 2015, the *Environmental Planning and Assessment Act 1979* and the Woollahra LEP 2014.

**Principal building form** The original front building section and main roof within a street front zone, which contains the main rooms (see diagram below)



**Pavilion addition** A structure located at the rear of the existing building, separated from the principal building form by a linking structure (see diagram below)



## B2.1.7 General Development Controls

The following objectives and controls apply to all neighbourhood HCAs. For Inter-War flat buildings, the provisions at B3.8.7 supplement the controls below.

Note: Refer to Figure 1 for design suggestions for rear additions.

B2.1.7 General Development Controls	
Objectives	Controls
O1 To ensure that the significant fabric of heritage items and contributory buildings is retained.	<p>C1 Contributory items are retained and conserved, with no external alterations or additions made to significant elevations, details, materials or finishes except for maintenance or restoration.</p> <p>C2 Any replacement of significant building fabric is of a similar material and type (e.g. timber for timber, terracotta for terracotta).</p> <p>C3 Principal roof forms, including roof pitch, roof planes, eaves height and chimneys, are to be retained, with the exception of rear dormers and skylights.</p> <p>C4 Infilling (by glazing or otherwise) of original verandahs or balconies is not permitted. Where verandahs/balconies have been infilled, they are to be reinstated.</p> <p>C5 Painting, bagging or rendering of original face brickwork is not to occur. Reinstatement of facebrick finish is encouraged where brickwork has been painted or rendered.</p>
O2 To ensure that significant internal fabric is retained and conserved.	<p>C6 Original room layouts and proportions are retained in the principal building forms. New openings in internal walls and floors and ceiling structures lateral to party walls must retain the structural integrity of the building and its neighbours, and should retain significant original ceilings and cornices. Interpretation of the original layout is to be provided with suitable portal frames, nibs or bulkheads.</p> <p>C7 Significant internal features within the principal building form are retained,</p>



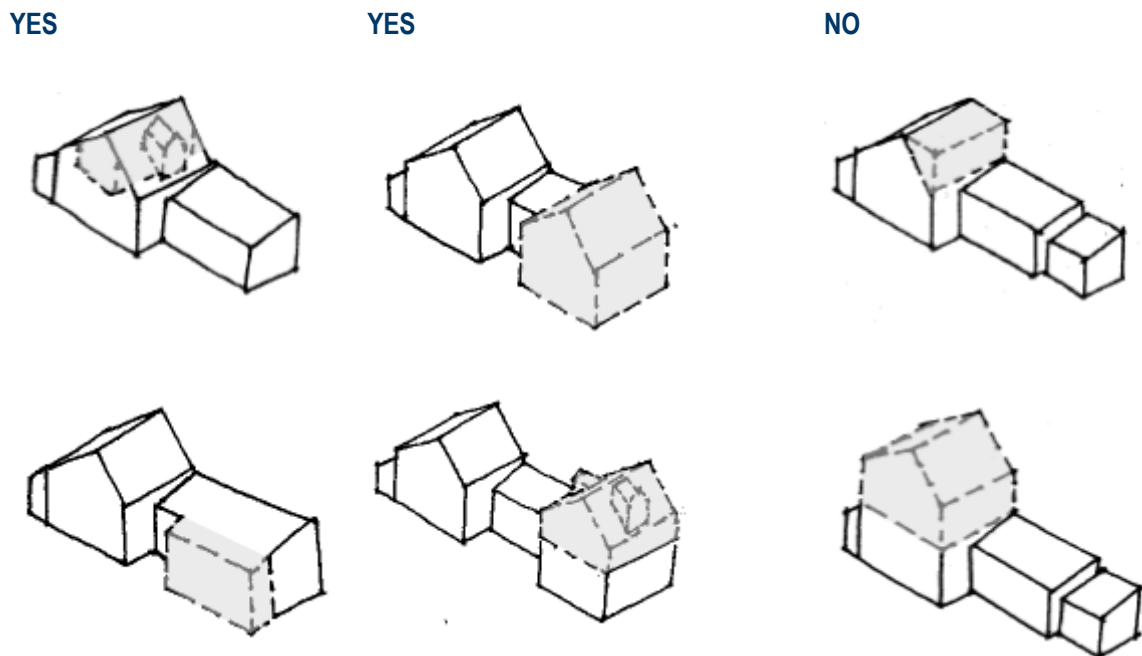
B2.1.7 General Development Controls	
Objectives	Controls
	including (but not limited to) staircases, joinery, fireplaces and decorated ceilings.
<p>O3 To retain, restore and promote the significance, contribution and relationship of a building within the context of a pair or group of buildings.</p>	<p>C8 The visual dominance and cohesiveness of a pair or group of buildings is retained and development does not obscure or reduce their visual relationship from the public domain.</p>
<p>O4 To ensure that the curtilage of heritage items and contributory buildings is retained and enhanced when opportunity arises.</p>	<p>C9 Additional storeys are not permitted to the principal building form. Additions may be located at the rear or in areas of less significance.</p>
<p>O5 To maintain the existing building scale, form and height of the main streetscape elevation, and ensure new development is compatible with the streetscape.</p>	<p>C10 Roof space within the principal building form may be used if there will be no change to the existing roof height, roof pitch, eaves height or ceiling below.</p>
<p>O6 To ensure that rear alterations and additions are of sympathetic design and construction.</p>	<p>C11 Where suitable, a rear pavilion addition connected to the principal building form via a linking structure can be allowed, if:</p>
<p>O7 To ensure that the architectural character of buildings is not compromised.</p>	<ul style="list-style-type: none"> <li>▪ The height of the rear addition is equal or inferior to the maximum ridgeline of the main building;</li> </ul>
<p>O8 To ensure that alterations and additions are sympathetic to the original building and the predominant streetscape character contributing to the heritage conservation area’s significance.</p>	<ul style="list-style-type: none"> <li>▪ The rear addition complements the character of the principal building form in terms of materials, solid-to-void ratios; and</li> <li>▪ It will not adversely affect the setting of the main building by retaining the rear roof plane and rear wall intact.</li> </ul>
	<p>C12 New structures or additions visible from the public domain must use sympathetic materials and forms that are in character with the architectural style of the building and with other contributory buildings.</p>

B2.1.7 General Development Controls	
Objectives	Controls
	<p>C13 Additions to the side of a building may be permitted if set behind the main ridgeline of the existing building, and the additions:</p> <ul style="list-style-type: none"> <li>▪ are subservient and do not visually dominate the main building.</li> <li>▪ are designed to be sympathetic and complement the original building; and</li> <li>▪ front, rear and side setbacks will retain uniformity with adjoining development.</li> </ul>
<p>O9 To achieve external materials, finishes and colour schemes sympathetic to the context.</p>	<p>C14 New materials and details to additions must complement the architectural style of the existing building and minimise the apparent bulk of the addition. Light and traditional colours are to be used for predominant wall colours instead of dark colours.</p>
<p>O10 To conserve established garden settings, including original landscape elements and features.</p>	<p>C15 Garden settings are retained, including mature trees, original and early pathways, gates and front fencing.</p>
<p>O11 To ensure that the landscape character of the streetscape is maintained by preserving existing trees and sandstone kerbs and gutters.</p>	<p>C16 Existing street trees are retained.</p> <p>C17 Sandstone kerbs and gutters are retained and protected.</p>
<p>O12 To ensure that on-site parking does not dominate the streetscape.</p>	<p>C18 Car parking is set back behind the front building line. Parking spaces, carports or garages are not permitted in the front setback.</p> <p>C19 Despite C18, where there is no side setback greater than 3m, a single pergola car parking structure forward of the building line may be built forward of the building line and to the side of the property. Permeable paving is to be used to soften visual impact.</p>
<p>O13 To ensure that significant fences and sandstone walls are conserved.</p>	<p>C20 Sandstone fences and walls are retained and are not to be breached by additional openings.</p>

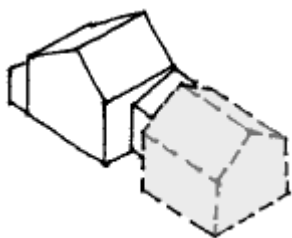
B2.1.7 General Development Controls	
Objectives	Controls
<p>O14 To ensure that fences do not detract from the streetscape.</p>	<p>C21 New fences are appropriate to the style and period of the building. They are made from masonry materials with brick or sandstone piers and infill and/or timber pickets or steel balustrading with at least 25% transparency. Maximum height is 1.5m, pillars may extend to a maximum height of 1.8m.</p>
<p>O15 To ensure that infill development respects significant fabric, the existing subdivision layout and pattern of building separation.</p>	<p>C22 Subdivision or amalgamation will only be permitted if the resulting development respects the subdivision pattern and does not require the demolition of a heritage item or contributory building or compromise its setting.</p>
<p>O16 To ensure that infill development maintains the existing streetscape character and rhythm, building form and scale of buildings.</p>	<p>C23 Infill development is of a scale, form and character compatible with the surroundings and does not match a building that is excessive in terms of its bulk, height, scale or incompatible design.</p>
<p>O17 To maintain the streetscape appearance with uniform setbacks.</p>	<p>C24 Elevations visible from the public domain do not incorporate large expanses of glass, and openings are vertically proportioned.</p> <p>C25 Infill development has a consistent front setback, with appropriate landscaping. Where adjoining lots have different setbacks, then an average of the two is to be provided.</p> <p>C26 Infill development and additions must not extend beyond the predominant rear building setbacks at any level of a building.</p> <p>C27 Infill development maintains the existing building separation pattern to enable planting of side setbacks.</p>
<p>O18 To ensure that the pattern of roofscapes is maintained.</p>	<p>C28 Infill development has a consistent roof form, pitch and materials to that of the adjacent contributory buildings and the context.</p>

B2.1.7 General Development Controls	
Objectives	Controls
	<p>C29 Roof additions and utilities, such as skylights and dormers, are not to be visible from the street front zone (and side front zone for corner buildings).</p> <p>Note: Solar energy systems such as photovoltaic electricity generating systems, solar hot water systems, or solar air heating systems are addressed in Chapter E6, Section 6.3 Solar Energy Systems.</p>
<p>O19 To promote high quality design, materials, finishes and detailing which is appropriate to the architectural style, building type and historic context.</p>	<p>C30 Infill development does not replicate traditional details.</p> <p>C31 Colour schemes employ traditional colours, and predominantly light colours for walls.</p>

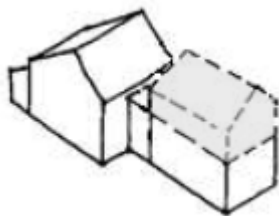
**FIGURE 1** Design suggestions for rear additions to contributory buildings, applicable to single storey houses, multi storey houses or flat buildings:



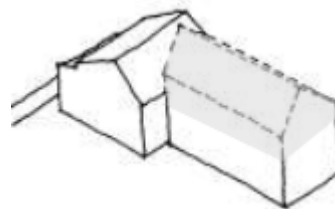
**YES**



**YES**

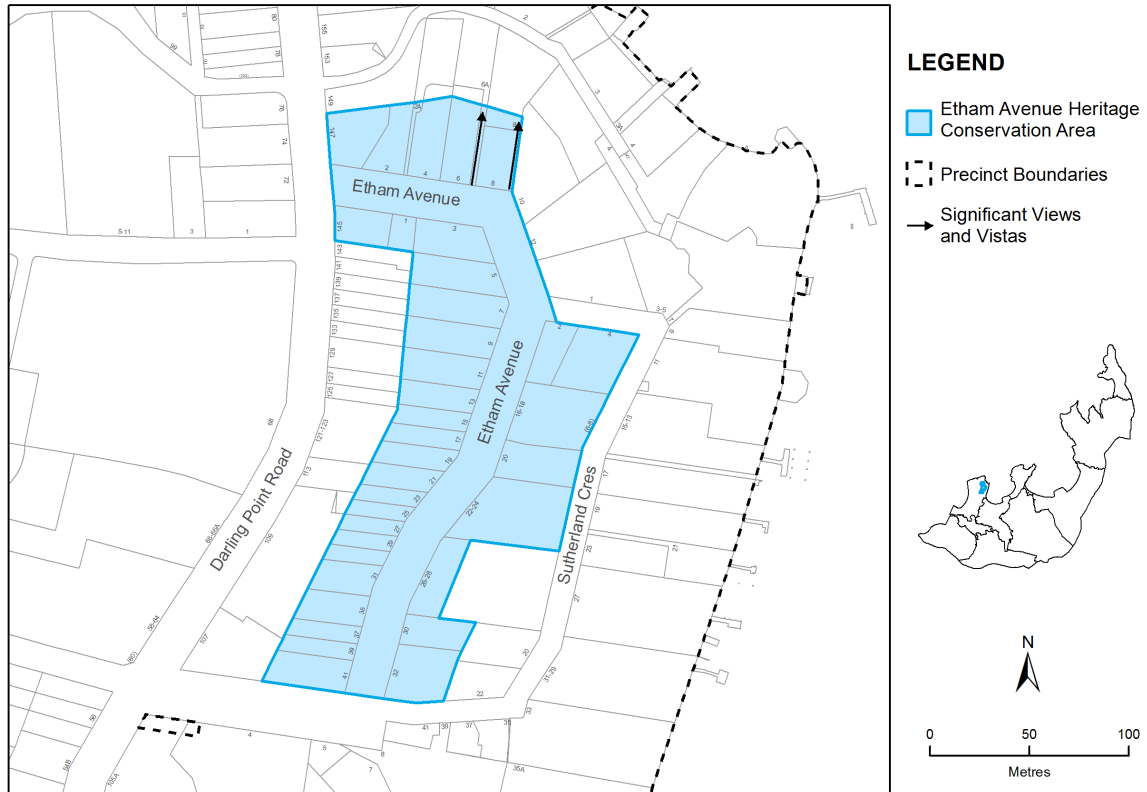


**NO**



## B2.2 Etham Avenue, Darling Point

MAP 2 Etham Avenue HCA



### Statement of significance

The Etham Avenue HCA is located within the Darling Point residential precinct and is characterised by high quality Federation residences and Inter-War buildings (flats and houses) of varying styles.

The Etham Avenue HCA provides a physical record of a significant historical phase in the urban subdivision of Darling Point. The historical subdivision pattern reflects the staged subdivision of part of the Etham Estate dating from 1900 and a subsequent re-subdivision after the demolition of the Etham Mansion circa 1920. There are distinct groups of buildings that provide physical evidence of the evolutionary development of the area when more compact residences were being designed with distinctly less accommodation for servants.

The Etham Avenue HCA has the distinctive character and layout of a compact early 20th century 'Garden Suburb', a movement based on the urban planning principles of Sir Ebenezer Howard. The streetscape has a high aesthetic value which is enhanced by the serpentine layout of the road along the contour, which creates closed vistas that focus on small cohesive groups of houses. The winding road provides a more complex view of the housing and is typical of the movement. The constant width of the road with its grass nature strip and avenue plantings contributes to the quality of streetscape. It retains three sandstone elements of the former Etham Mansion in the form of its gate and fence pillars.

The circa 1900 suburban subdivision pattern is largely intact and most of the housing derives from this period with characteristic stylistic details that make an important contribution to the HCA.

The housing displays the quality and distinction of a wide range of Federation styles from the excellent highly intact Federation Queen Anne housing at the southern end, to the English Arts and Craft styles, Inter-War Mediterranean and the American-influenced Federation Bungalow style at the northern end.

The consistency of the dominant roof forms and stylistic elements such as verandahs, porches, bay windows, chimneys, including semi-transparent and low metal railing front fencing in front gardens without terracing contributes to the strong streetscape qualities and create an aesthetically pleasing character.

**Desired future character**

- Development is to retain the significant fabric and key values of the Etham Avenue HCA included in the statement of significance. This includes retaining heritage items and contributory items as well as their curtilage. Development is to comply with the provisions outlined in B2.1.

**Contributory Items**

- While not individually listed as heritage items, contributory items contribute to the character of the HCA and are considered to contain significant fabric. Contributory items have been identified through heritage studies and surveys undertaken by Council.

Note: Heritage items as identified in Schedule 5 of Woollahra LEP 2014 are also contributory items.

Contributory Items	
145 Darling Point Road	Federation house
147 Darling Point Road	Inter-War house
1 Etham Avenue	Federation house
2 Etham Avenue	2 storey Federation house
3 Etham Avenue	Federation house
4 Etham Avenue	2 storey Federation house
6 Etham Avenue	Federation house
7 Etham Avenue	Federation house
8 Etham Avenue	Inter-War flat building

Contributory Items	
11 Etham Avenue	Inter-War flat building
13 Etham Avenue	Federation house
15 Etham Avenue	Federation house
17 Etham Avenue	Inter-War house
19 Etham Avenue	Victorian house
21 Etham Avenue	Federation house
22 Etham Avenue	Inter-War house
23 Etham Avenue	Federation house
25 Etham Avenue	Federation house
27 Etham Avenue	Federation house
33 Etham Avenue	Federation house
Etham Avenue	Street trees

### Heritage Items

- ▶ *Linden*, 1905 Federation Arts & Crafts house built for J L Weingarth at 9 Etham Avenue.
- ▶ Inter-War Californian Bungalow at 2 Sutherland Crescent built in 1923 for W. Roberts
- ▶ Inter-War Californian Bungalow at 4 Sutherland Crescent designed by Oakley & Middleton Architects for J Saunders in 1925
- ▶ *Craicievar*, Inter-War flat building at 32 Etham Avenue built for Mrs E. Dickson
- ▶ Federation Arts & Crafts group at 37, 39 and 41 Etham Avenue

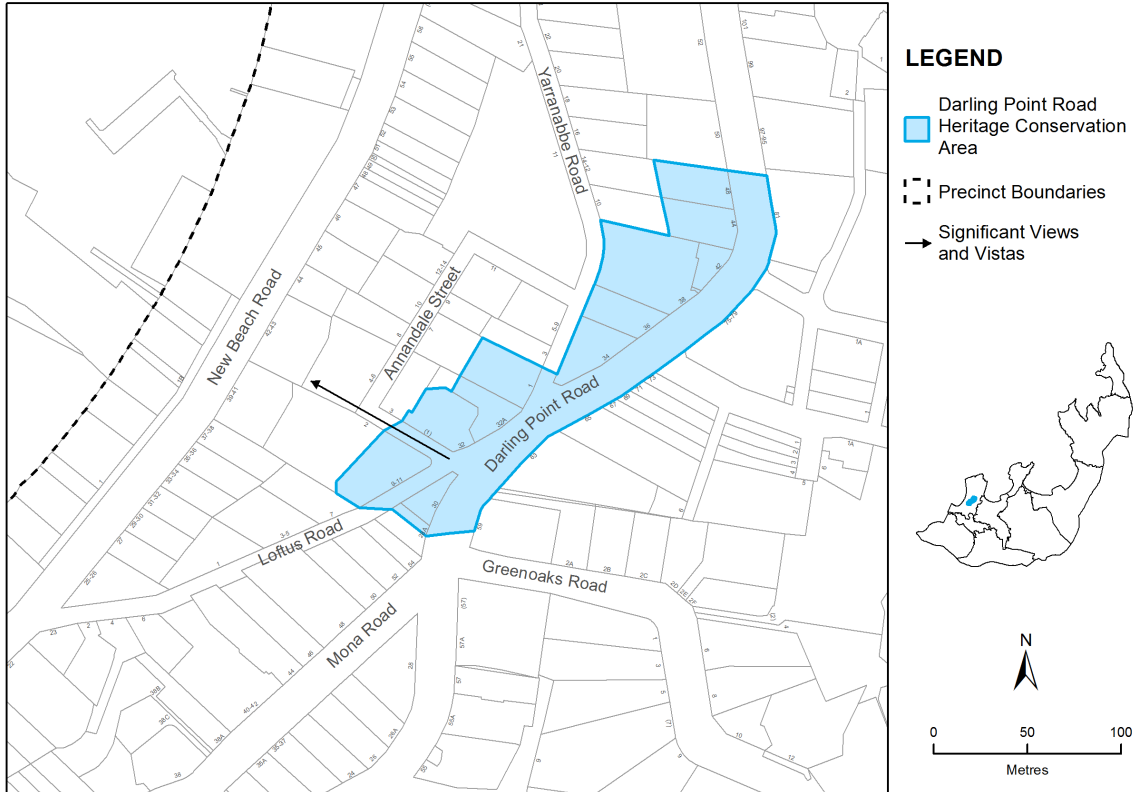
#### Note:

- ▶ The Etham Avenue HCA is located within the Darling Point precinct. The precinct character statement for the Darling Point precinct in Chapter B1 and these controls at B2.2 are to be read in conjunction with provisions at B2.1.
- ▶ The provisions at B2 apply in addition to the general development controls in Chapter B3 in this part of the DCP, including controls for Inter-War residential flat buildings (Section B3.8.7). Where there is an inconsistency, the provisions at B2.1 take precedence.



## B2.3 Darling Point Road, Darling Point

MAP 3 Darling Point Road HCA, Darling Point



### Statement of significance

The Darling Point Road HCA is located within the Darling Point residential precinct and comprises cohesive groups of substantial late 19th and early 20th century houses in the Federation Gothic and Federation Arts and Crafts styles and residential flat buildings, either original or formed by the alteration of large houses.

The conservation area makes an important contribution to the identity of Darling Point with its prominent steeply pitched roofscapes and mature garden settings with traditional fences.

Darling Point Road, as the main thoroughfare since the layout of Mrs Darling's Point in 1833, winds along the ridge through the township towards the harbour. This central location is historically associated with the influential members of colonial society and the establishment of the Anglican Church of St Marks during the mid-19th century.

The earlier stage of more intense residential development at Darling Point is represented by the large and architecturally distinctive Gothic houses adjacent to the St Marks Church precinct, which were part of the c1841 Glenhurst Estate subdivision.

The second significant phase of development was associated with the 1907 Springfield Estate subdivision. Examples include the substantial houses at Nos. 42, 44-46 and 48 Darling Point Road which are representative of the Federation Queen Anne style with Arts and Crafts influence.

Their siting as a group on the winding Darling Point Road following the contours and their honest use of local materials reflects the principles of the Garden Suburb movement.

### Desired future character

- ▶ Development is to retain the significant fabric and key values of the Darling Point Road HCA included in the statement of significance. This includes retaining heritage items and contributory items as well as their curtilage. Development is to comply with the provisions outlined in B2.1.

### Contributory Items

- ▶ While not individually listed as heritage items, contributory items contribute to the character of the HCA and are considered to contain significant fabric. Contributory items have been identified through heritage studies and surveys undertaken by Council.

Note: Heritage items as identified in Schedule 5 of Woollahra LEP 2014 are also contributory items.

Contributory Items	
32A Darling Point Road	<i>Awelon</i> , Inter-War house
34 Darling Point Road	House
36 Darling Point Road	House
Loftus Reserve	Council reserve

### Heritage Items

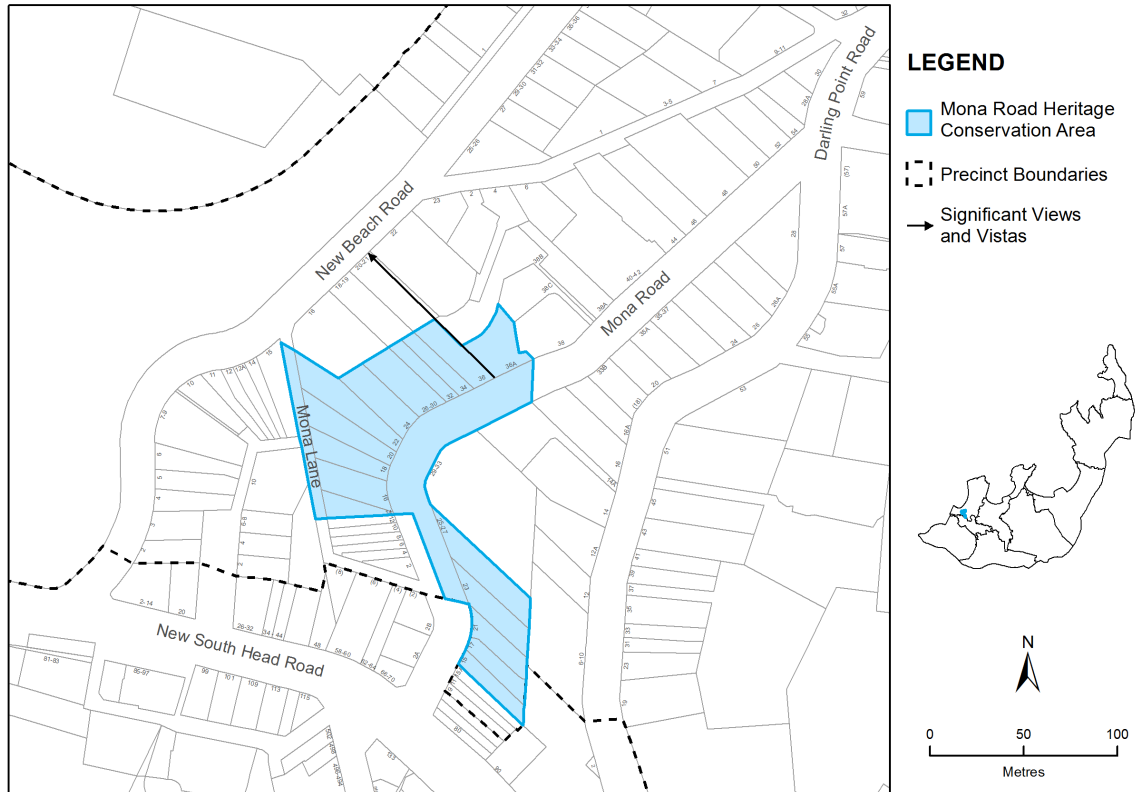
- ▶ *Cloncorrick* at No. 32 Darling Point Road, which was designed by the notable architect John Horbury Hunt for the Honourable George Simpson; and
- ▶ *St Canice* at 9-11 Loftus Road, which was designed for the Honourable Edward Butler around 1864, possibly by Architect John Frederick Hilly.
- ▶ The 1908 Federation Arts and Crafts house at 1 Yarranabbe Road.
- ▶ The house at No. 42 is a substantial intact house, designed in the restrained English Queen Anne style with Arts and Crafts influences. It has a stepped plan, face brickwork and multi-gabled roof which address both the southern and eastern approaches.
- ▶ The pair of semi-detached dwellings at Nos. 44 and 46 is skillfully designed to read as a single house in the Federation Arts and Craft style. They feature characteristic elements of tall tapered roughcast chimney, large face brick arches, intersecting gables and tapering columns with restrained timberwork.
- ▶ *Leamington*, the house at No. 48 is a relatively rare example of the Federation Arts and Craft movement in Sydney. It retains a high level of external intactness and integrity of its original Australian design in face brickwork rather than being covered in roughcast. It responds to the local climate by incorporating side verandahs and wider eaves.

Note:

- ▶ The Darling Point Road HCA is located within the Darling Point precinct. The precinct character statement for the Darling Point precinct in Chapter B1 and these controls at B2.3 are to be read in conjunction with the provisions at B2.1.
- ▶ The provisions at B2 apply in addition to the general development controls in Chapter B3 in this part of the DCP, including controls for Inter-War residential flat buildings (Section B3.8.7). Where there is an inconsistency, the provisions at B2.1 take precedence.

## B2.4 Mona Road, Darling Point

MAP 4 Mona Road HCA



### Statement of significance

The Mona Road HCA is located within the Darling Point residential precinct and comprises dwelling houses, semi-detached houses and flat buildings that demonstrate the important characteristics of the Victorian, Federation Arts and Crafts and Federation Queen Anne styles.

This HCA contains cohesive groups of substantial but speculative housing built within the first decade of the 20th century on part of the Mona Estate that demonstrates the more intense residential development pattern of Darling Point. Some of the dwellings were subsequently converted to duplexes or triplexes in the 1920s without changing their form or altering their integrity.

The winding alignment of Mona Road through the steep topography results in extensive rusticated ashlar or brick retaining walls which, together with the mature Hill's Weeping Fig street trees and the Federation subdivision pattern, form a distinctive streetscape with cohesive groups of buildings on each side of Mona Road.

On the western side of the street, the buildings are characterised by the rhythmic tiled roofscapes of Federation dwellings and semi-detached dwellings designed to read as single houses.

These houses are orientated towards the harbour and were designed to be accessed from Rushcutters Park via Mona Lane, rather than Mona Road.

**Desired future character**

- ▶ Development is to retain the significant fabric and key values of the Mona Road HCA. This includes retaining heritage items and contributory items as well as their curtilage. Development is to comply with the provisions outlined in B2.1.

**Contributory Items**

- ▶ While not individually listed as heritage items, contributory items contribute to the character of the HCA and are considered to contain significant fabric. Contributory items have been identified through heritage studies and surveys undertaken by Council.

Note: Heritage items as identified in Schedule 5 of Woollahra LEP 2014 are also contributory items.

Contributory Items	
22 Mona Road	Federation house
24 Mona Road	Federation house
26-30 Mona Road	Federation flat building
32 Mona Road	<i>Radnor</i> , Federation semi-detached house
34 Mona Road	<i>Booren</i> , Federation semi-detached house
36 Mona Road	Federation house
Mona Lane	Sandstone wall
Mona Road	Street trees

**Heritage Items**

- ▶ The houses at Nos. 14-16 are adjoining two-storey red brick houses in the Federation Queen Anne style with rusticated sandstone foundation walls and terracotta tiled roofs.
- ▶ The houses at Nos. 18-22 are substantial adjoining identical houses designed in the Federation Queen Anne style with face brick, rusticated sandstone foundation walls and slate roofs. Together with Nos. 14 and 16, the sandstone retaining wall to Mona Lane continues the characteristic relationship of the building with the landforms.

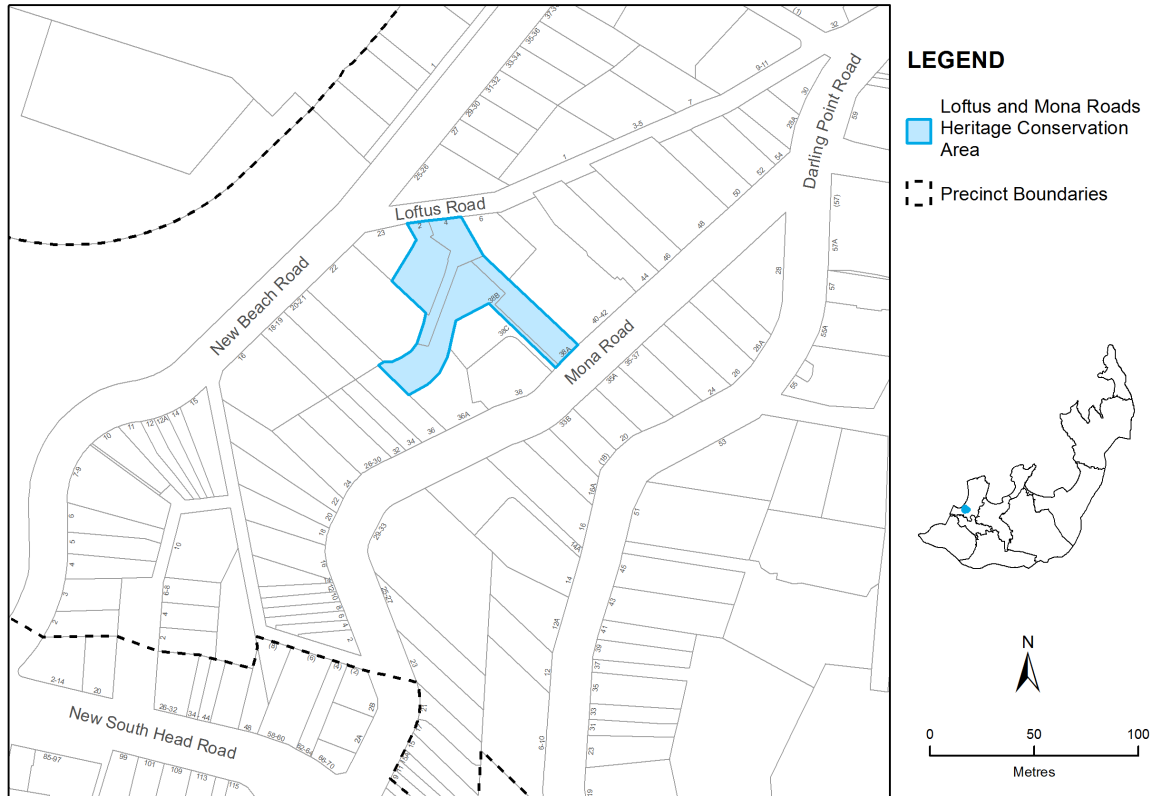
- 
- ▶ No. 36a is a landmark face brick building in the Federation Queen Anne Old English style at the northern end of the group, adjacent to *Mona*.
  - ▶ Nos. 15-17 which comprise elevated dwellings and semi-detached dwellings that are fine red brick examples of the Federation Queen Anne style with bow windows, prominent gable ends, decorative fretwork balustrades and tiled with Marseille pattern terracotta tile.
  - ▶ No.21-23 (*Graycliffe Flats*) which are two adjoining houses built in the Federation Arts and Crafts style later converted into flats.
  - ▶ No. 25-27 which is a three-storey Federation Arts and Crafts styled apartment building in an elevated setting that demonstrates a strong massing with heavy articulation of its roughcast and face brick elevations with restrained decoration and weatherboard balustrading.

Note:

- ▶ The Mona Road HCA is located within the Darling Point precinct. The precinct character statement in Chapter B1 and these controls at B2.4 are to be read in conjunction with the provisions at B2.1.
- ▶ The provisions at B2 apply in addition to the general development controls in Chapter B3 in this part of the DCP, including controls for Inter-War residential flat buildings (Section B3.8.7). Where there is an inconsistency, the provisions at B2.1 take precedence.

## B2.5 Loftus Road and Mona Road, Darling Point

MAP 5 Loftus Road and Mona Road HCA



### Statement of significance

The Loftus Road and Mona Road HCA is a group of four residential flat buildings of similar scale, bulk, design and materials, located at 2 and 4 Loftus Road and 38a and 38b Mona Road. These were built on steep land subdivided from the grounds of the Victorian Regency styled house *Mona*, currently adaptively re-used as a flat building.

The Loftus Road and Mona Road group is a significant group of Inter-War flat buildings which appear as a cohesive and substantial presence on the slopes of Darling Point. The area is significant in demonstrating the trend towards closer subdivision and development of fashionable flats in Darling Point during the 1920s and 1930s as a response to the changing planning regulations.

Each building was designed by prominent architectural firms of the time, Peddle Thorpe & Walker and Crane & Scott, in the Inter-War Mediterranean style. Each of the buildings contain architectural features which are highly representative of the Inter-War Mediterranean style such as timber shutters, Marseille tiled roofs, Juliet balconies and arched openings.

The flats are generously sized and some originally included maid's rooms within the lower levels. The group is unusually intact and has retained the garden terraces with Inter-War plantings and substantial sandstone retaining walls from earlier estates.

### Desired future character

- ▶ Development is to conserve the significant fabric and cohesive character of the Inter-War flat buildings in the Loftus Road and Mona Road HCA. This includes retaining heritage items and contributory items as well as their curtilage. Development is to comply with the provisions outlined in B3.8.7.

### Contributory Items

- ▶ While not individually listed as heritage items, contributory items contribute to the character of the HCA and are considered to contain significant fabric. Contributory items have been identified through heritage studies and surveys undertaken by Council.

Note: Heritage items as identified in Schedule 5 of Woollahra LEP2014 are also contributory items.

Contributory Items	
38A Mona Road	<i>Brailsford</i> , Inter-War flat building
38B Mona Road	<i>Burford House</i> , Inter-War flat building
2 Loftus Road	Inter-War flat building

### Heritage Item

- ▶ *St Martin's* at 4 Loftus Road is a large imposing Inter-War Mediterranean style three storey flat building. It has simplified classical detailing in the Mediterranean style, with a terracotta tiled roof with a band of medallions beneath, timber shutters, and a parapet with a deep entablature featuring medallions. It was designed in 1926 by Crane & Scott Architects for Finlay McLeod.

Note:

- ▶ The Loftus Road and Mona Road HCA is located within the Darling Point precinct. The precinct character statement in Chapter B1 in this part of the DCP and these controls at B2.5 are to be read in conjunction with the controls at B2.1.
- ▶ The provisions at B2 apply in addition to the general development controls in Chapter B3 in this part of the DCP; this includes controls for Inter-War flat buildings (Chapter B3 Section B3.8.7). Where there is an inconsistency, the provisions at B2.1 take precedence.



## B2.6 Aston Gardens, Bellevue Hill

MAP 6 Aston Gardens HCA



### Statement of significance

The Aston Gardens HCA is an outstanding group of significant Inter-War flat buildings designed by prominent architects that remain largely intact in their fabric, 1927 subdivision pattern and garden settings.

Aston Gardens is rare in that nearly every architectural style of the Inter-War period is represented in the one street. Many of the flats are large and many originally included servant’s quarters. The area is significant in demonstrating the move away from large freestanding houses to modern and fashionable flats during the Inter-War period and the changing planning regulations increasing the density of the inner suburbs of Sydney.

The Inter-War flat buildings are 2 to 4 storeys in height, in Spanish Mission, Georgian Revival and Art Deco styles in a landscaped garden setting. The intact subdivision occupies the north-east facing slope that falls steeply away from Victoria Road. The buildings are constructed of face brick or rendered brick with generally timber double hung windows (some with timber shutters) and generally hipped and gabled roof forms with terra cotta roof tiles. The facades feature decorative render/plasterwork, and/or brick detailing.

### Desired future character

- ▶ Development is to conserve the significant fabric of the Aston Gardens HCA. This includes retaining contributory items as well as their curtilage. Development is to comply with the provisions outlined in B3.8.7.

### Contributory Items

- ▶ While not individually listed as heritage items, contributory items contribute to the character of the HCA and are considered to contain significant fabric. Contributory items have been identified through heritage studies and surveys undertaken by Council.

Note: Heritage items as identified in Schedule 5 of Woollahra LEP 2014 are also contributory items.

Contributory Items	
1 Aston Gardens	<i>Gloucester House</i> , Inter-War flat building
2 Aston Gardens	Inter-War flat building
3 Aston Gardens	<i>Novar</i> , Inter-War flat building
4 Aston Gardens	<i>Kalorama</i> , Inter-War flat building
5 Aston Gardens	Inter-War flat building
6 Aston Gardens	<i>Braemar</i> , Inter-War flat building
7 Aston Gardens	<i>Miramar</i> , Inter-War flat building
8 Aston Gardens	<i>Mirradong</i> , Inter-War flat building
9 Aston Gardens	<i>Cranston</i> , Inter-War flat building

Note:

- ▶ The Aston Gardens HCA is located within the Bellevue Hill North precinct. The precinct character statement for the Bellevue Hill North precinct in Chapter B1 and these controls at B2.6 are to be read in conjunction with the provisions at B2.1.
- ▶ The provisions at B2 apply in addition to the general development controls in Chapter B3 in this part of the DCP; this includes controls for Inter-War flat buildings (Chapter B3 Section B3.8.7). Where there is an inconsistency, the provisions at B2.1 take precedence.

## B2.7 Victoria Road, Bellevue Hill

MAP 7 Victoria Road HCA



### Statement of significance

The Victoria Road HCA is located to the southern side of Victoria Road near the upper limits of Cooper Park at 165-179 Victoria Road, Bellevue Hill. The HCA contains a cohesive group of buildings which demonstrates the forms and styles employed in the consolidation of residential areas of the Woollahra Municipality in the late Inter-War period.

The buildings demonstrate the aesthetic preferences of late Inter-War development by a variety of persistent revival styles, namely the Inter-War Old English and Georgian Revival styles, and the increasingly modern Inter-War Art Deco and Functionalist styles. The buildings are consistent in scale, mass and orientation to the street.

The buildings are of smooth and textured face brick construction with terracotta Marseille tile roofs, partially concealed by raised and detailed brick parapets to the street frontage.

Typical materials include polychromatic brickwork incorporating heraldic motifs and label moulds, tapestry pattern brickwork and stepped and vertically aligned brickwork to parapets which enhances the HCA’s aesthetic significance. Coloured lead lighting patterned glazing to express stairways and multi-paned window sashes reinforce the eclectic use of stylistic elements in the buildings. Raised parapets and high gables provide silhouetted forms against the skyline whilst sandstone faced basement garages provide a pediment to many of the buildings.

Specialised finishes include limited use of glazed architectural terracotta, chromed door hardware and timber panelling to the entry lobbies.

The buildings, whilst commonly altered in detail, retain external forms, fabric, detailing and hard landscaping from the original period of construction.

The group retains much of its original landmark relationship to Victoria Road and the ridgeline setting opposite the upper boundary of Cooper Park.

#### Desired future character

- ▶ Development is to conserve the significant fabric and cohesive character of the Inter-War flat buildings in the Victoria Road HCA. This includes retaining heritage items and contributory items as well as their curtilage. Development is to comply with the provisions outlined in B3.8.7.

#### Contributory Items

- ▶ While not individually listed as heritage items, contributory items contribute to the character of the HCA and are considered to contain significant fabric. Contributory items have been identified through heritage studies and surveys undertaken by Council.

Note: Heritage items as identified in Schedule 5 of Woollahra LEP 2014 are also contributory items.

Contributory Items	
169-171 Victoria Road	<i>Hillcrest</i> , Inter-War flat building
175 Victoria Road	Inter-War flat building
177 Victoria Road	Inter-War flat building
179 Victoria Road	Inter-War flat building

#### Heritage Item

- ▶ The Art Deco Inter-War flat buildings at 165 and 167 Victoria Road built for developer H E Rogers.

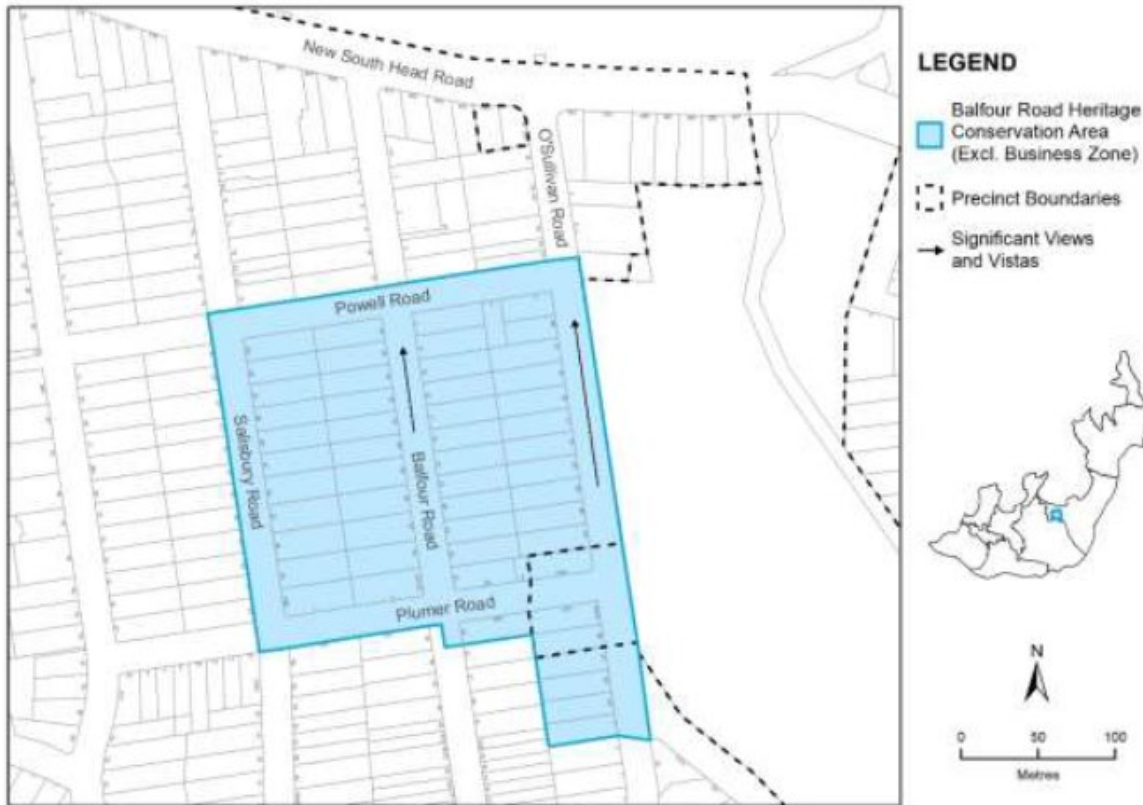
Note:

- ▶ The Victoria Road HCA is located within the Bellevue Hill South precinct. The precinct character statement for the Bellevue Hill South precinct in Chapter B1 and these controls at B2.7 are to be read in conjunction with the provisions at B2.1.

The provisions at B2 apply in addition to the general development controls in Chapter B3 in this part of the DCP; this includes controls for Inter-War flat buildings (Chapter B3 Section B3.8.7). Where there is an inconsistency, the provisions at B2.1 take precedence.

## B2.8 Balfour Road, Rose Bay/Bellevue Hill

**MAP 8** Balfour Road HCA



### Statement of significance

The Balfour Road HCA lies in the valley of Rose Bay in proximity to the harbour foreshore just south of New South Head Road, and is characterised by Inter-War houses and flat buildings.

This HCA represents the intensified residential development of Bellevue Hill and Rose Bay in the Inter-War period following subdivisions of the Beresford Estate and the introduction of regular public transport along New South Head Road after 1903.

The housing stock comprises bungalows and flat buildings dating from the mid-1920s and mid-1930s, which display distinctive architectural characteristics of the Inter-War period. Many demonstrate outstanding craftsmanship in brick detailing and remain substantially unaltered from their original appearance, incorporating distinctive design motifs and original low brick fences. The facebrick flat buildings create cohesive streetscapes of similarly scaled and detailed buildings with open landscaped front yards set in wide tree lined avenues. The houses are typical bungalows dating from the late Federation and Inter-War period.

The precinct has heritage significance at a local level for values related to historic evolution and aesthetic values and represents the local heritage theme of suburban expansion and consolidation.

The Beresford Estate subdivision is characterised by a rectilinear road and subdivision pattern that provides visual and functional links to surrounding areas including the harbour and the nearby golf club.

Note: This HCA contains a local neighbourhood centre, known as the Plumer Road shops. The shops have a business zoning; the relevant objectives and controls for these buildings are contained in Part D of the DCP, Chapter D2 Mixed Use Centres and Chapter D3 General Controls for Neighbourhood and Mixed Used Centres.

### Desired future character

- ▶ Development is to retain the significant fabric and key values of the Balfour Road HCA included in the statement of significance. Development is to comply with the provisions outlined in B2.1.

### Contributory Items

- ▶ While not individually listed as heritage items, contributory items contribute to the character of the HCA and are considered to contain significant fabric. Contributory items have been identified through heritage studies and surveys undertaken by Council.

Note: Heritage items as identified in Schedule 5 of Woollahra LEP 2014 are also contributory items.

Contributory Items	
11 Balfour Road	Inter-War flat building
13 Balfour Road	Inter-War flat building
14 Balfour Road	Inter-War flat building
15 Balfour Road	Inter-War house
16 Balfour Road	Inter-War Californian Bungalow
17 Balfour Road	<i>Bognor</i> , Inter-War flat building
20 Balfour Road	<i>Gladstone Hall</i> , Inter-War flat building
22 Balfour Road	<i>Ashton</i> , Inter-War flat building
24 Balfour Road	<i>Woodburn</i> Inter-War flat building
26 Balfour Road	<i>Tudor Towers</i> , Inter-War flat building

Contributory Items	
27 Balfour Road	Inter-War flat building
28 Balfour Road	Inter-War flat building
29 Balfour Road	Inter-War flat building
30 Balfour Road	<i>Loxley</i> , Inter-War flat building
31 Balfour Road (aka 5 Plumer Road)	Inter-War flat building
32 Balfour Road	<i>Chiltern</i> , Inter-War flat building
33 Balfour Road (aka 22 Plumer Road)	Inter-War flat building
34-36 Balfour Road (aka 3 Plumer Road)	<i>Yalabee</i> , Inter-War flat building
7 Plumer Road	Inter-War substation
9-23 Plumer Road	Inter-War commercial building
2 Powell Road	Inter-War flat building
4 Powell Road	Inter-War flat building
71 O'Sullivan Road	Inter-War flat building
81 O'Sullivan Road	<i>Golf View Court</i> , Inter-War flat building
83 O'Sullivan Road	Inter-War flat building
85 O'Sullivan Road	<i>Knowle Court</i> , Inter-War flat building
87 O'Sullivan Road	Inter-War flat building
89-93 O'Sullivan Road (aka 24 Plumer Road)	Inter-War commercial building

Contributory Items	
99 O'Sullivan Road	<i>Glamis</i> , Inter-War flat building
20 Salisbury Road	Inter-War Bungalow
22 Salisbury Road	Inter-War Bungalow
24 Salisbury Road	Inter-War Bungalow
26 Salisbury Road	Inter-War Bungalow
28 Salisbury Road	<i>St Dunstons</i> , Inter-War flat building
30 Salisbury Road	Inter-War flat building
32 Salisbury Road	<i>Tarana</i> , Inter-War flat building
34 Salisbury Road	Inter-War flat building
36 Salisbury Road	<i>Cranston</i> , Inter-War flat building
38 Salisbury Road	<i>Darlington</i> , Inter-War flat building
40 Salisbury Road (aka 1 Plumer Road)	Inter-War flat building
Balfour Road	Street trees
Salisbury Road	Street trees
O'Sullivan Road	Street trees

### Heritage Items

- ▶ *St Bernard Hall*, the Art Deco style Inter-War flat building at 9 Balfour Road built by J M Park.
- ▶ The group of Inter-War flat buildings at 19 (*Wycombe*), 21, 23 and 25 Balfour Road (*Springfield*) built by local developers H Rogers (1939), J B McNamara (1939), H Rogers (39) and E Miller (1936).
- ▶ Bus stop shelter at the intersection with Plumer Road.
- ▶ *Darnley*, the Inter-War Mediterranean flat building at 79 O'Sullivan Road developed by Dr L. Taylor (1933).



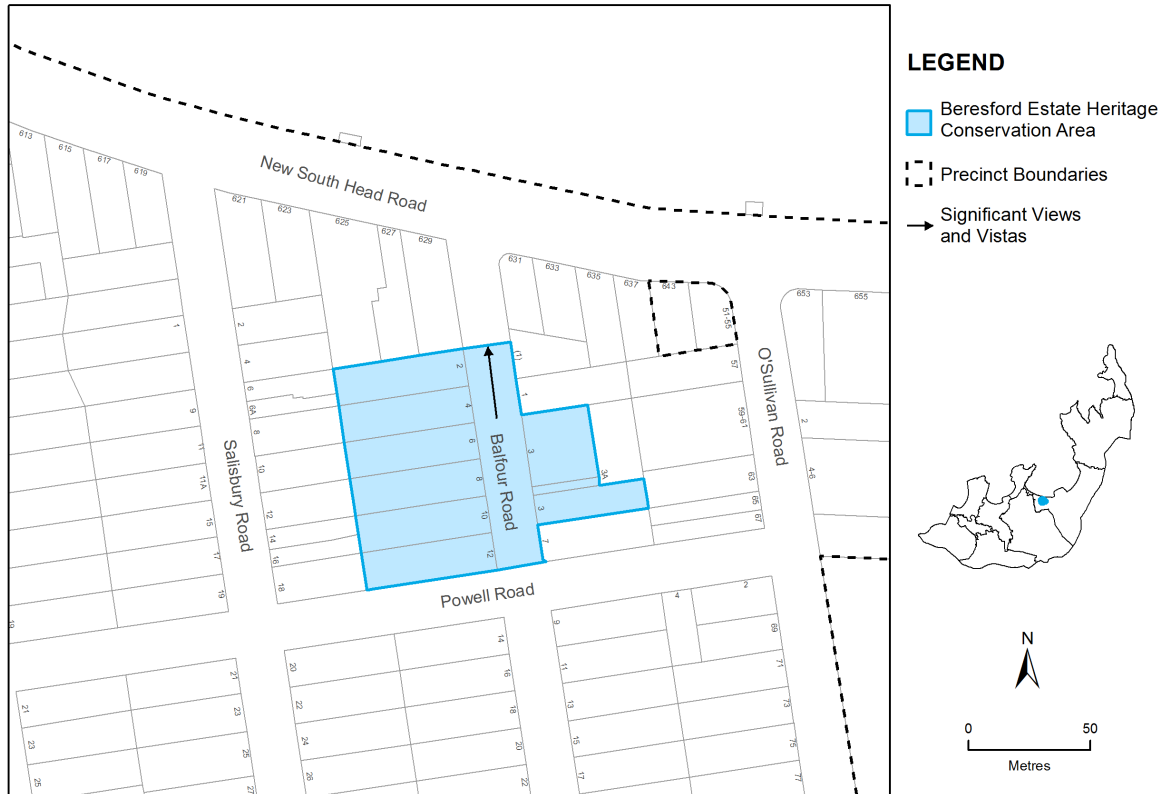
- ▶ *Avalon*, the Art Deco style Inter-War flat building at 97 O’Sullivan Road developed by M M Hogg (1939).
- ▶ A pair of Art Deco style Inter-War flat buildings at 101 O’Sullivan Road and 1 Latimer Road developed by P. Samsonovich (1933 and 1934).

Note:

- ▶ The Balfour Road HCA is located within the Bellevue Hill North precinct. The precinct character statement for the Bellevue Hill North precinct in Chapter B1 and these controls at B2.8 are to be read in conjunction with the provisions at B2.1.
- ▶ The provisions at B2 apply in addition to those in Chapter B3 of this part of the DCP, General Development Controls, including controls for Inter-War flat buildings (Section B3.8.7). Where there is an inconsistency, the provisions at B2.1 take precedence.

## B2.9 Beresford Estate, Rose Bay

### MAP 9 Beresford Estate HCA



#### Statement of significance

The Beresford Estate HCA in Balfour Road, Rose Bay, is a Federation Arts and Crafts Group, which represents the early subdivision and development of the Beresford Estate close to New South Head Road in the first decades of the 20th century. It provides evidence of the historic processes related to this part of the suburb through the subdivision of the grounds of the Rose Bay Lodge and as a result of the introduction of the Rose Bay Tram service in 1903.

The group demonstrates a variety of characteristic external elements of the Federation Arts and Crafts style of architecture, including broad walls of rough cast render with face brick often on sandstone bases, dominant roofs in slate or terracotta tiles with prominent chimneys, and decorative timber detailing. These demonstrate the fashionable use of prominent gable features and arched openings and occasional buttressed walls. The gardens generally remain as informal layouts, retaining mature trees and original stone walls with wrought iron details or brick fencing with timber details.

The dwellings and their gardens form a cohesive and aesthetically significant group, and are representative of Federation dwellings in Rose Bay.

**Desired future character**

- ▶ Development is to conserve the significant fabric of the Federation Arts and Crafts Group in the Beresford Estate HCA. This includes retaining heritage items, contributory items as well as their curtilage. Development is to comply with the provisions outlined in B2.1.

**Contributory Items**

- ▶ While not individually listed as heritage items, contributory items contribute to the character of the HCA and are considered to contain significant fabric. Contributory items have been identified through heritage studies and surveys undertaken by Council.

Note: Heritage items as identified in Schedule 5 of Woollahra LEP 2014 are also contributory items.

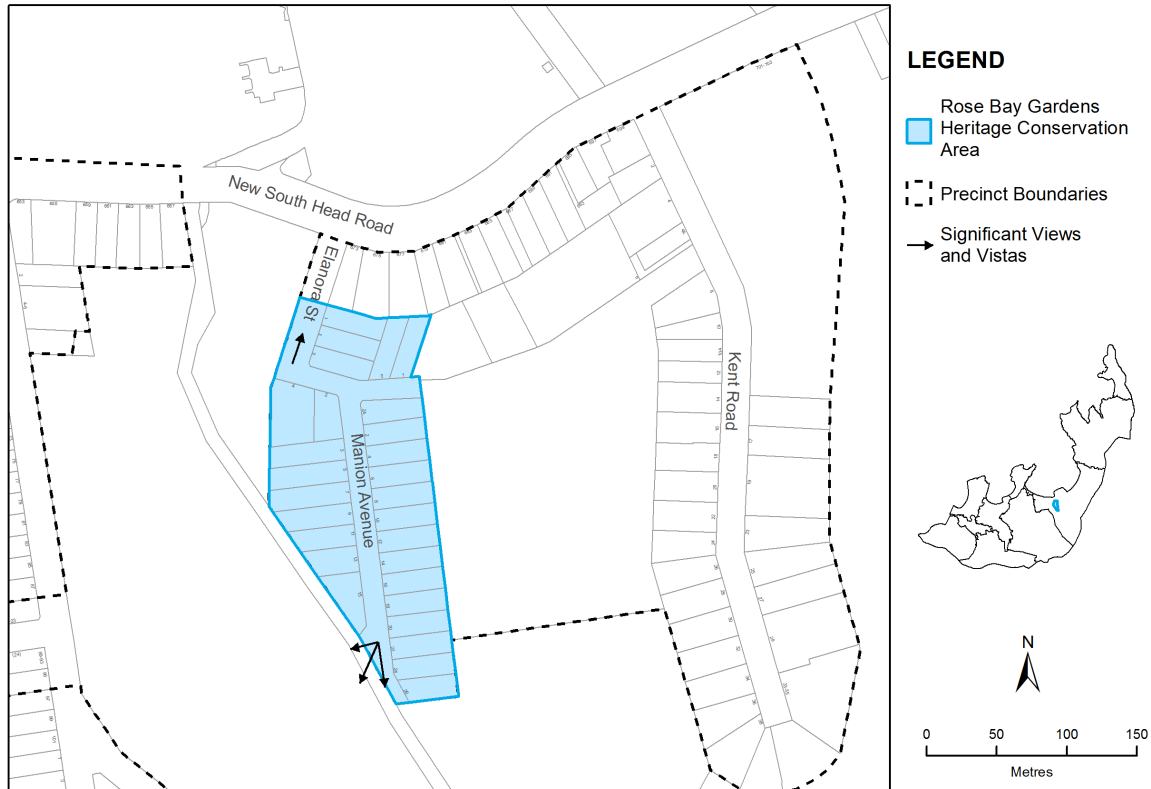
Contributory Items	
2 Balfour Road	<i>Glen Alpin</i> , Federation house
3 Balfour Road	Federation house
4 Balfour Road	Federation house
6 Balfour Road	Federation house
8 Balfour Road	Federation house
10 Balfour Road	Federation house
12 Balfour Road	Federation house

Note:

- ▶ The Beresford Estate HCA is located within the Bellevue Hill North precinct. The precinct character statement for the Bellevue Hill North precinct in Chapter B1 and these controls at B2.9 are to be read in conjunction with the provisions at B2.1.
- ▶ The provisions at B2 apply in addition to the general development controls in Chapter B3 in this part of the DCP, including controls for Inter-War residential flat buildings (Section B3.8.7). Where there is an inconsistency, the provisions at B2.1 take precedence.

## B2.10 Rose Bay Gardens Estate, Rose Bay

### MAP 10 Rose Bay Gardens Estate HCA



#### Statement of significance

The Rose Bay Gardens Estate HCA is situated in the flat valley behind Rose Bay south of New South Head Road and Lyne Park. This HCA contains an outstanding group of largely intact Inter-War flat buildings dating from 1930 to 1939, some of which were designed by prominent architects.

The buildings are two to three storeys and constructed of face brick with Art Deco detailing, generally timber double-hung windows and generally hipped and gabled roof forms with terracotta roof tiles. The facades feature decorative render, plasterwork, and/or brick detailing. The buildings also have a landscaped garden setting and low masonry front fences, which complement the buildings.

The group has retained their garden settings, and the subdivision pattern of the street is intact. The area is significant in demonstrating the move away from large freestanding houses to modern and fashionable flats in the Inter-War period and the changing planning regulations increasing the density of the inner suburbs of Sydney.

### Desired future character

- Development is to retain the significant fabric and cohesive character of the Inter-War flat buildings in the Rose Bay Gardens Estate HCA. This includes retaining contributory items as well as their curtilage. Development is to comply with the provisions outlined in B3.8.7.

### Contributory Items

- While not individually listed as heritage items, contributory items contribute to the character of the HCA and are considered to contain significant fabric. Contributory items have been identified through heritage studies and surveys undertaken by Council.

Note: Heritage items as identified in Schedule 5 of Woollahra LEP 2014 are also contributory items.

Contributory Items	
1 Elanora Street	<i>Bonny View</i> , Inter-War flat building
3 Elanora Street	<i>Tintagel</i> , Inter-War flat building
5 Elanora Street	<i>Toorak</i> , Inter-War flat building
1 Iluka Street	<i>Cardwel</i> , Inter-War flat building
2 Iluka Street	<i>Roslyn</i> , Inter-War flat building
3 Iluka Street	Inter-War flat building
4 Iluka Street	<i>Dorchester</i> , Inter-War flat building
1 Manion Avenue	<i>Gainsborough</i> , Inter-War flat building
2 Manion Avenue	<i>Kinvarra</i> , Inter-War flat building
3 Manion Avenue	<i>Embassy</i> , Inter-War flat building
4 Manion Avenue	<i>Carnarvon</i> , Inter-War flat building
5 Manion Avenue	<i>Werrington</i> , Inter-War flat building
6 Manion Avenue	<i>Clairvaux</i> , Inter-War flat building
7 Manion Avenue	<i>Rosemont</i> , Inter-War flat building

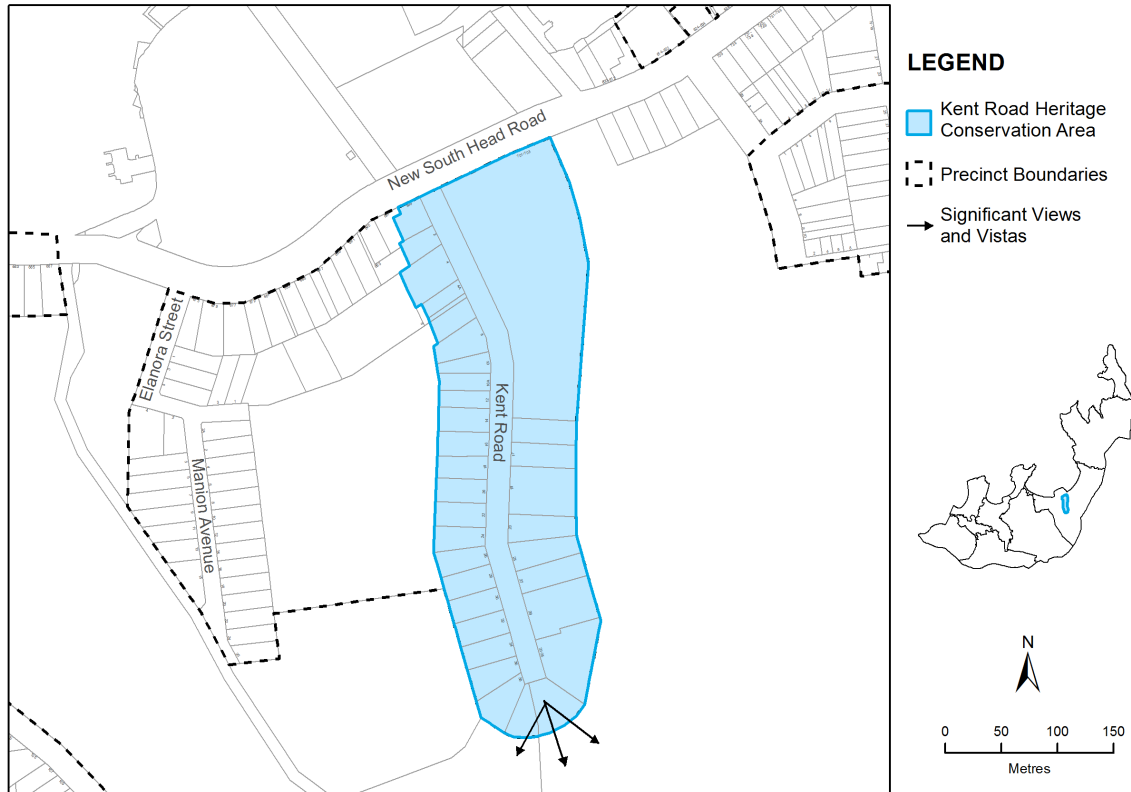
Contributory Items	
8 Manion Avenue	Inter-War flat building
9 Manion Avenue	<i>Toronto</i> , Inter-War flat building
10 Manion Avenue	<i>Greystanes</i> , Inter-War flat building
11 Manion Avenue	<i>Novacastría</i> , Inter-War flat building
12 Manion Avenue	<i>Cardington</i> , Inter-War flat building
13 Manion Avenue	<i>Marlborough</i> , Inter-War flat building
14 Manion Avenue	<i>Chiswick</i> , Inter-War flat building
15 Manion Avenue	<i>Cambridge</i> , Inter-War flat building
16 Manion Avenue	<i>Chatsworth</i> , Inter-War flat building
18 Manion Avenue	<i>Brenchley</i> , Inter-War flat building
20 Manion Avenue	<i>Chesterton</i> , Inter-War flat building
22 Manion Avenue	Inter-War flat building
24 Manion Avenue	Inter-War flat building
26 Manion Avenue	<i>Grantham</i> , Inter-War flat building

## Note:

- ▶ The Rose Bay Gardens Estate is located within the Rose Bay precinct. The precinct character statement for the Rose Bay precinct in Chapter B1 and these controls at B2.10 are to be read in conjunction with the provisions at B2.1.
- ▶ The provisions at B2 apply in addition to the general development controls in Chapter B3 of this part of the DCP, General Development Controls, including controls for Inter-War flat buildings (Section B3.8.7). Where there is an inconsistency, the provisions at B2.1 take precedence.

## B2.11 Kent Road, Rose Bay

MAP 11 Kent Road HCA



### Statement of significance

Kent Road is a long cul-de-sac located off the southern side of New South Head Road opposite the reclaimed land, which forms Lyne Park. It is an important part of the extended setting of the Royal Sydney Golf Club, with the road and its related subdivision creating the western edge of the golf links. The golf clubhouse is located at the lower northern end where it is the dominant element.

The Kent Road HCA represents a distinct, isolated pocket of residential development in the Rose Bay area, arising directly from the historical development and financial activities of the Royal Sydney Golf Club.

The road is dominated at its lower end by the impressive mass and detail of the historically, aesthetically and socially significant 1920s Clubhouse building and its immediate setting. The contributory buildings in the street are:

- substantial late Federation era Arts & Crafts style houses on the eastern side of the road overlooking the golf links which were well established before the 1919 "Knoll" subdivision sale; and
- Inter-War flats and houses built between 1920 and the late 1930s which were a direct result of rapid residential expansion of Rose Bay following the First World War

Amongst these buildings are a number of excellent representative and rare examples of Inter-War residential development by prominent architects which are of local significance within the Woollahra Municipality.

Kent Road itself is wide with street trees of varying species and maturity, along with wide verges and footpaths. It rises steeply to the 'knoll' and contains a double bend following the contours, which adds to the character of the streetscape, creating a series of enclosed vistas. The road terminates in the cul-de-sac with views over the Golf links and beyond up to Dover Heights.

The area also has significant aesthetic qualities arising from the overall form and layout of the subdivision, the presence of prominent mature gardens and the character created by a variety of substantial street tree plantations.

### Desired future character

- ▶ Development is to retain significant fabric and key values of the Kent Road HCA included in the statement of significance. This includes retaining heritage items and contributory items as well as their curtilage. Development is to comply with the provisions outlined in B2.1.

### Contributory Items

- ▶ While not individually listed as heritage items, contributory items contribute to the character of the HCA and are considered to contain significant fabric. Contributory items have been identified through heritage studies and surveys undertaken by Council.

Note: Heritage items as identified in Schedule 5 of Woollahra LEP 2014 are also contributory items.

Contributory Items	
2 Kent Road	<i>Kentwood</i> , Inter-War flat building
10A Kent Road	<i>Erifilli</i> , Inter-War flat building
12 Kent Road	<i>Gleneagle</i> , Inter-War flat building
14 Kent Road	Inter-War house
18 Kent Road	<i>Penrhos</i> , Inter-War house
22 Kent Road	Inter-War house
23 Kent Road	<i>Te Puke</i> , Federation house
24 Kent Road	Inter-War flat building
25 Kent Road	<i>Belsize</i> , Federation house



Contributory Items	
27 Kent Road	<i>Lynton</i> , Federation house
28 Kent Road	<i>Narua Flats</i> , Inter-War flat building
29-31 Kent Road	<i>Sama Jean</i> , Federation house
30 Kent Road	Inter-War house
36 Kent Road	Inter-War house
38 Kent Road	Inter-War flat building
Kent Road	Street trees

### Heritage Items

- ▶ *Royal Sydney Golf Club*, Federation Arts & Crafts building designed by Halliday & Wilton Architects in 1922 after a major fire destroyed the 1905 building.
- ▶ Federation Arts and Crafts house at 699 New South Head Road, built in 1914 for J M Macdonald.
- ▶ *Fermoyle*, Inter-War flat building at 4A Kent Road, developed by P M Pegum in 1934 by Fowell & McConnell Architects.
- ▶ *Sherland Lodge* at 16 Kent Road, 1923 Inter-War Mediterranean style house by Architect Kenneth Webb, modified by Joseland & Gilling in 1932.
- ▶ *Samares*, c1909 Arts & Crafts house at 17 Kent Road for Dr. J Flashman.
- ▶ *The Knoll*, Inter-War Georgian Revival style house at 19 Kent Road, designed by Scott, Green & Scott Architects for W. A. Freeman in 1935.
- ▶ *Tudor House*, 1924 Old English Style Inter-War flat building at 20 Kent Road built by L L Messey.
- ▶ Inter-War Georgian Revival house at 32 Kent Road designed by Spain & Cosh Architects in 1936 for F M Johnson.

#### Note:

- ▶ The Kent Road HCA is located within the Rose Bay precinct. The precinct character statement for the Rose Bay precinct in Chapter B1 and these controls at B2.11 are to be read in conjunction with the provisions at B2.1.
- ▶ The provisions at B2 apply in addition to the general development controls in Chapter B3 of this part of the DCP, General Development Controls, including controls for Inter-War flat buildings (Section B3.8.7). Where there is an inconsistency, the provisions at B2.1 take precedence.

## B2.12 Bell Street, Vacluse

### MAP 12 Bell Street HCA



### Statement of significance

Bell Street HCA contains a cohesive collection of 1 and 2 storey late Victorian cottages, constructed of weatherboard and corrugated iron with timber double-hung windows and timber panelled doors. The streetscape includes timber picket fences and street trees.

Bell Street has strong historical associations with the village of Watsons Bay as it functioned as part of the adjoining village. The group of cottages can still be seen and understood in the context of the nearby Anglican and Roman Catholic Churches which served the village.

On the route to South Head the street forms an important visual introduction to the historic Watsons Bay village, and this scenic quality is enhanced by its location next to the bend of Old South Head Road from where the whole group can be appreciated as a single entity.

The conservation area was part of the Beaconsfield Estate owned by Sir John Robertson and the subdivision pattern he created in 1887 remains intact. Bell Street's weatherboard and corrugated iron cottages, which form a coherent and contiguous group, are rare in the Woollahra Municipality.

### Desired future character

- ▶ Development is to retain the significant fabric and key values of the Bell Street HCA. This includes retaining contributory items as well as their curtilage. Development is to comply with the provisions outlined in B2.1.
- ▶ Development generally follows the form of the established cottages with simple, rectangular volumes and traditionally pitched roofs.

### Contributory Items

- ▶ While not individually listed as heritage items, contributory items contribute to the character of the HCA and are considered to contain significant fabric. Contributory items have been identified through heritage studies and surveys undertaken by Council.

Note: Heritage items as identified in Schedule 5 of Woollahra LEP 2014 are also contributory items.

Contributory Items	
4 Bell Street	Weatherboard house
6 Bell Street	Weatherboard house
7 Bell Street	Weatherboard house, associated with noted 19 <sup>th</sup> century Australian watercolourist Pilford Fletcher Watson
8 Bell Street	Weatherboard house
10 Bell Street	Weatherboard house
11 Bell Street	Weatherboard house
12 Bell Street	Weatherboard house
14 Bell Street	Weatherboard house
16 Bell Street	Weatherboard house
18 Bell Street	Weatherboard house

Note:

- ▶ The Bell Street HCA is located within the Vaucluse East precinct. The precinct character statement for the Vaucluse East precinct in Chapter B1 and these controls at B2.2 are to be read in conjunction with the provisions at B2.1.

- ▶ The provisions at B2 apply in addition to the general development controls in Chapter B3 in this part of the DCP, including controls for Inter-War residential flat buildings (Section B3.8.7). Where there is an inconsistency, the provisions at B2.1 take precedence.



**FIGURE 2** Bell Street, Vacluse

# Chapter B3 General Development Controls

Part B ► General Residential

CHAPTER B3 APPROVED ON 10 APRIL 2017  
AND COMMENCED ON 19 APRIL 2017

Last amended on 26 July 2024



# Chapter B3 ► General Development Controls

## Contents

<b>B3.1</b>	<b>INTRODUCTION</b> .....	<b>1</b>
	B3.1.1 Land where this chapter applies .....	1
	B3.1.2 Development to which this chapter applies .....	2
	B3.1.3 Design Excellence .....	3
	B3.1.4 Relationship to other parts of the DCP .....	3
	B3.1.5 How to use this chapter .....	4
<b>B3.2</b>	<b>BUILDING ENVELOPE</b> .....	<b>5</b>
	B3.2.1 Where the building envelope controls apply .....	5
	B3.2.2 Front setback .....	7
	B3.2.3 Side setbacks .....	10
	B3.2.4 Rear setback .....	13
	B3.2.5 Wall height and inclined plane .....	15
<b>B3.3</b>	<b>FLOORPLATE</b> .....	<b>17</b>
<b>B3.4</b>	<b>EXCAVATION</b> .....	<b>22</b>
<b>B3.5</b>	<b>BUILT FORM AND CONTEXT</b> .....	<b>26</b>
	B3.5.1 Streetscape and local character .....	26
	B3.5.2 Overshadowing .....	28
	B3.5.3 Public and private views .....	29
	B3.5.4 Acoustic and visual privacy .....	33
	B3.5.5 Internal amenity .....	38
<b>B3.6</b>	<b>ON-SITE PARKING</b> .....	<b>40</b>
<b>B3.7</b>	<b>EXTERNAL AREAS</b> .....	<b>44</b>
	B3.7.1 Landscaped areas and private open space .....	44
	B3.7.2 Fences .....	52
	B3.7.3 Site facilities .....	56
	B3.7.4 Ancillary development - swimming pools, tennis, basketball and sports courts and outbuildings .....	62
<b>B3.8</b>	<b>ADDITIONAL CONTROLS FOR DEVELOPMENT OTHER THAN DWELLING HOUSES</b> .....	<b>67</b>
	B3.8.1 Minimum lot width .....	67
	B3.8.2 Secondary dwellings .....	69
	B3.8.3 Semi-detached dwellings .....	70
	B3.8.4 Dual occupancy .....	73
	B3.8.5 Attached dwellings .....	74
	B3.8.6 Residential flat buildings, manor houses, multi dwelling housing and multi dwelling housing (terraces) .....	75
	B3.8.7 Inter-War flat buildings .....	77
	B3.8.8 Post-1950s residential towers .....	86
	B3.8.9 Non-residential development .....	87
<b>B3.9</b>	<b>ADDITIONAL CONTROLS FOR DEVELOPMENT ON A BATTLE-AXE LOT</b> .....	<b>89</b>
<b>B3.10</b>	<b>ADDITIONAL CONTROLS FOR DEVELOPMENT IN SENSITIVE LOCATIONS</b> .....	<b>93</b>





## B3.1 Introduction

This is Chapter B3 of the Woollahra Development Control Plan 2015 (DCP), Part B General Residential. The controls in this chapter must be read in conjunction with the controls in Chapter B1 Residential Precincts and Chapter D2 Neighbourhood Heritage Conservation Areas (HCAs).

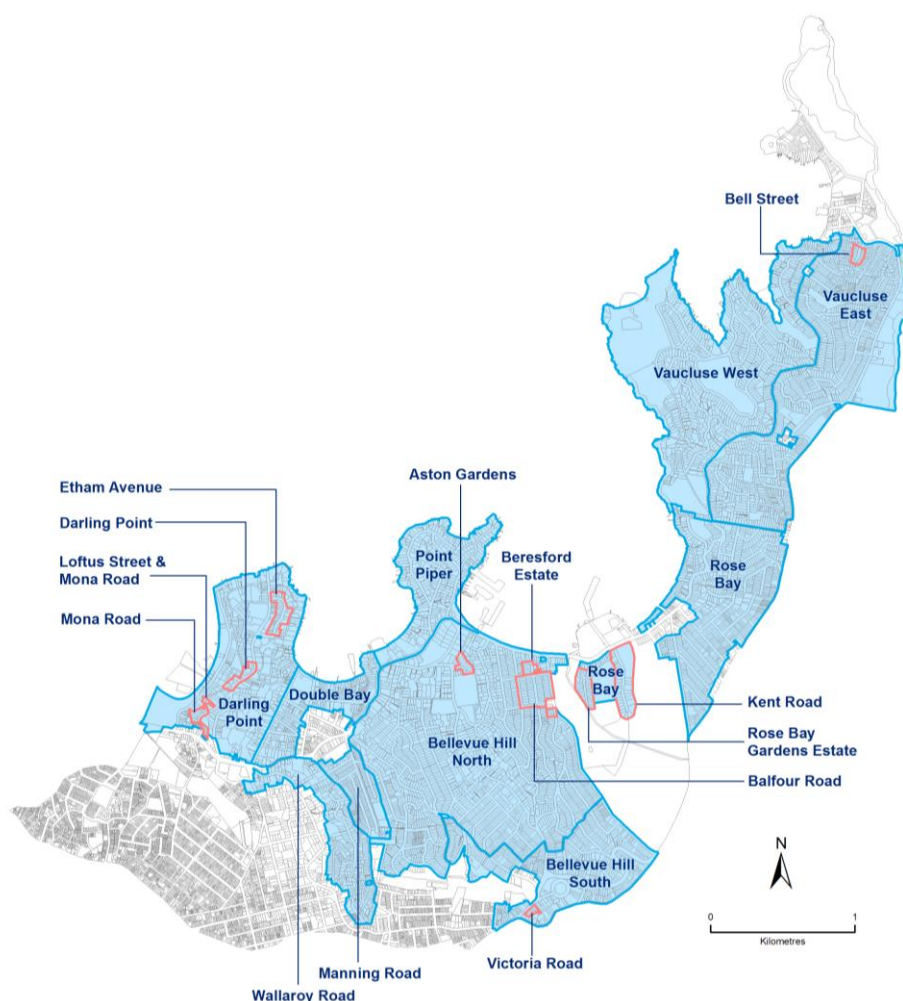
The Woollahra Local Environmental Plan 2014 (Woollahra LEP 2014) includes building height controls, floor space ratios for dwelling houses, semi-detached dwellings and dual occupancies outside HCAs, floor space ratios in the R3 Medium Density Residential Zone and the minimum lot size required for subdividing or developing land.

The controls in this chapter guide the scale and bulk of development so that is compatible with site conditions and the desired future character of the location where the development is proposed.

### B3.1.1 Land where this chapter applies

This chapter applies to land identified on Map 1 below.

#### MAP 1 The land where this chapter applies



The area comprises:

#### 10 Residential Precincts

- ▶ Darling Point
- ▶ Double Bay
- ▶ Wallaroy
- ▶ Manning Road
- ▶ Point Piper
- ▶ Bellevue Hill South
- ▶ Bellevue Hill North
- ▶ Rose Bay
- ▶ Vaucluse West
- ▶ Vaucluse East

#### 11 Neighbourhood HCAs

- ▶ Etham Avenue, Darling Point
- ▶ Darling Point Road, Darling Point
- ▶ Mona Road, Darling Point
- ▶ Loftus Road and Mona Road, Darling Point
- ▶ Aston Gardens, Bellevue Hill
- ▶ Victoria Road, Bellevue Hill
- ▶ Balfour Road, Rose Bay
- ▶ Beresford Estate, Rose Bay
- ▶ Rose Bay Gardens Estate, Rose Bay
- ▶ Kent Road, Rose Bay
- ▶ Bell Street, Vaucluse

### B3.1.2 Development to which this chapter applies

---

This chapter applies to development that requires development consent. This includes new development and additions and alterations.

Generally this will be residential development, but may include other permitted uses such as child care centres, community facilities, educational establishments, neighbourhood shops and places of public worship, and other uses permitted in Woollahra LEP 2014.

This area is predominantly zoned R2 Low Density Residential and R3 Medium Density Residential, but also includes land zoned SP2 Infrastructure, RE1 Public Recreation, RE2 Private Recreation, C1 National Parks and Nature Reserves and C2 Environmental Conservation.

**Note:** Those provisions in Woollahra DCP 2015 that specify requirements, standards or controls that relate to certain matters which are listed in clause 6A of the State Environmental Planning Policy No 65 - Design Quality of Residential Apartment Development (SEPP 65) have no effect in the assessment and determination of a development application for development to which SEPP 65 applies.

Residential apartment development is defined in clause 4 of SEPP 65. It comprises residential flat buildings, shop top housing and mixed use development with a residential accommodation component. The building must be at least three or more storeys (excluding levels below existing ground level or levels that are less than 1.2m above existing ground level that provide car parking). The building must contain at least four or more dwellings.

All other provisions of Woollahra DCP 2015 apply to the assessment and determination of a DA for development to which SEPP 65 applies.

---

### B3.1.3 Design Excellence

---

Woollahra Council has a strong commitment to design excellence. Design excellence may be achieved by development that meets the following criteria, as well as all other relevant objectives and controls in this chapter:

1. Development contributes positively to the desired future character of the relevant residential precinct described in section B1 of this DCP.
2. Development respects the natural, built and cultural significance of the site and its location.
3. Development conserves and protects canopy trees and plantings of landscape value and deep soil landscaping and, where possible, enhances tree canopy, plantings and deep soil landscaping.
4. Development responds to the topography.
5. Development contributes positively to the streetscape.
6. Development provides high levels of amenity for both the private and public domain.
7. Development incorporates the principles of ecologically sustainable development, such as:
  - minimising energy consumption,
  - reducing potable water use,
  - using energy and water efficient appliances,
  - using environmentally friendly products, and
  - enhancing indoor environmental quality.
8. Development must be of a skilful design that provides high levels of public benefit including the protection of the amenity of neighbouring properties, enhancing the public domain and integrating with the scenic character of Sydney Harbour. Proposals must demonstrate how the design of the development is the best option for achieving these outcomes.

---

### B3.1.4 Relationship to other parts of the DCP

---

This chapter is to be read in conjunction with the other parts of the DCP that are relevant to the development proposal, including:

- ▶ Part B: Chapter B1 Residential Precincts OR Chapter B2 Neighbourhood HCAs, depending on the location of the proposed development.
- ▶ Part E: General Controls for All Development - this part contains chapters on Parking and Access, Stormwater and Flood Risk Management, Tree Management, Contaminated Land, Waste Management, Sustainability, Signage and Adaptable Housing.
- ▶ Part F: Land Use Specific Controls - this part contains chapters on Child Care Centres, Educational Establishments, Licensed Premises and Telecommunications.

---

### B3.1.5 How to use this chapter

---

This chapter establishes controls for the following topics:

- ▶ building envelopes;
- ▶ floorplate (ONLY apply to development other than dwelling houses, semi-detached dwellings, secondary dwellings and dual occupancies on land in the R2 Low Density Residential Zone);
- ▶ excavation;
- ▶ built form and context;
- ▶ on-site parking;
- ▶ external areas;
- ▶ additional controls for development other than a dwelling house;
- ▶ additional controls for development on a battle-axe lot; and
- ▶ additional controls for development in sensitive locations (for example harbour foreshore development and land adjoining public open space).

The controls in this chapter comprise the following elements:

- ▶ **Explanation of the topic:**

This provides background information on why the topic is important, how it is relevant to building design, and how the controls should be applied.

- ▶ **Table of objectives and controls:**

The objectives describe the outcomes that proposed development is required to achieve. Applicants need to demonstrate how their development fulfils the relevant objectives for each topic. The controls represent specific ways in which a development proposal can meet the objectives. The intent of the controls must be interpreted in the context of the topic's objectives.

Development is required to address all the relevant controls. Where there is an inconsistency between these general controls and the precinct specific controls in Chapter B2, those specific controls in Chapter B2 take precedence over the general controls.

## B3.2 Building envelope

The building envelope is a three dimensional space within which a building is to be located. The maximum floor space permitted within the building envelope is determined by the floor space ratio (FSR) in Woollahra LEP 2014. All development must comply with the applicable FSR control. However, the floorplate control applies to development other than dwelling houses, semi-detached dwellings and dual occupancies in the R2 Low Density Residential Zone.

### B3.2.1 Where the building envelope controls apply

#### Development in the R2 Low Density Residential Zone and development for dwelling houses, semi-detached dwellings and dual occupancies in the R3 medium Density Residential zone

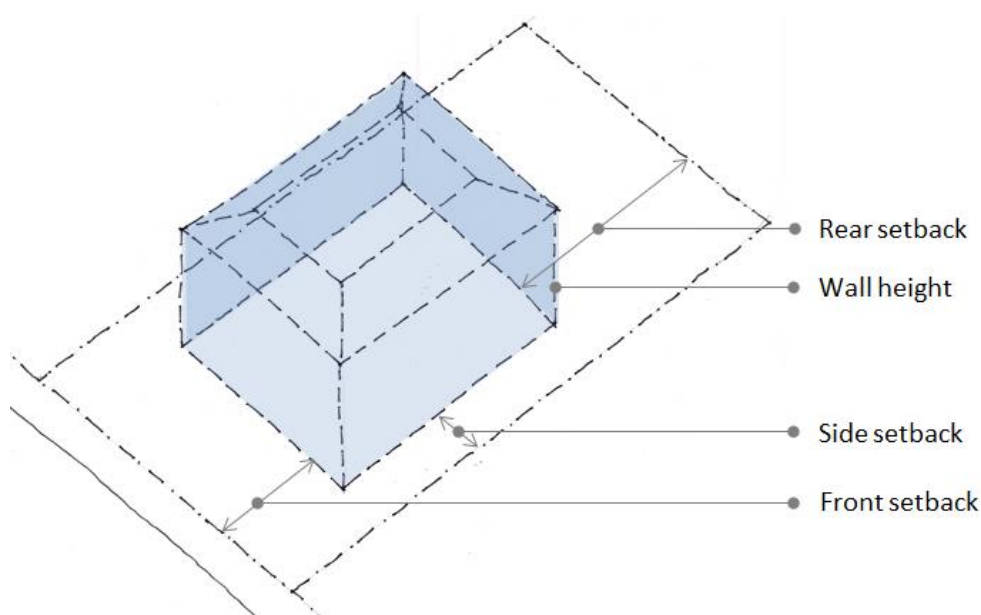
The building envelope (as shown in Figure 1) is established by applying the following controls:

- ▶ front, side and rear setbacks;
- ▶ maximum wall height of 7.2m;
- ▶ inclined plane of 45° taken from the maximum wall height; and
- ▶ maximum building height set by Woollahra LEP 2014.

All elements of the building (including decks, balconies, entry porches, verandahs, porte-cocheres, undercrofts and the like) are to be contained within the building envelope. There is an allowance for eaves outside the building envelope as long as the protrusion is below the inclined plane (where one applies).

Note: Additional controls apply to development on a battle-axe lot (refer Section B3.9).

**FIGURE 1** Building envelope



### Development in the R3 Medium Density Residential Zone

In the R3 Medium Density Residential Zone (or development other than dwelling houses, semi-detached and dual occupancies) the building envelope is established by applying the following controls:

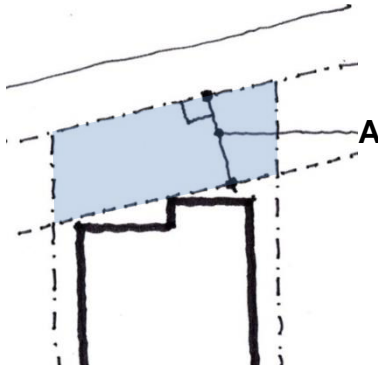
- ▶ front, side and rear setbacks;
- ▶ maximum building height set by Woollahra LEP 2014.

The wall height and inclined plane and floorplate controls do not apply.

### B3.2.2 Front setback

Front setbacks establish the position of buildings in relation to the street boundary. They create the spatial proportions of the street and can contribute to the streetscape character by providing consistency.

Buildings and plantings on private land form essential parts of the streetscape. Front setbacks should be used to enhance the setting for the building, providing landscaped areas and access to the building.



**FIGURE 2**

Front setback measurement

Example

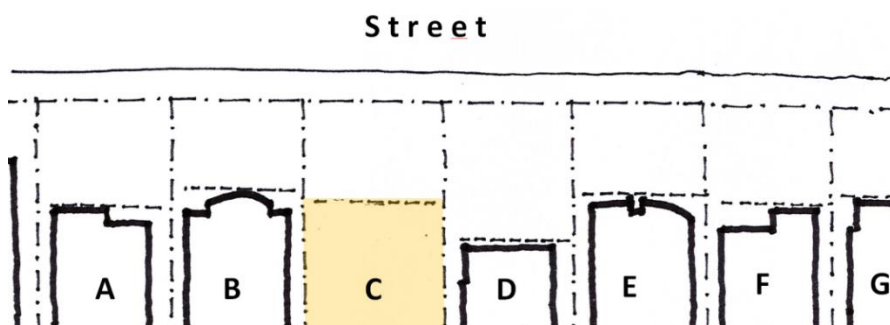
**A** = Front setback measured at 90° to the front boundary

B3.2 Building envelope ▶ 3.2.2 Front setback	
Objectives	Controls
<p>O1 To reinforce the existing streetscape and character of the location.</p> <p>O2 To provide consistent front setbacks in each street.</p> <p>O3 To provide for landscaped area and deep soil planting forward of the building.</p>	<p>C1 The front setback of the building envelope is determined by averaging the three most typical setbacks of the four closest residential buildings that face the same side of the street (refer to Figure 3).</p> <p>Note: The setback is determined by the distance between the primary street boundary and the outside face of the front building wall, or any protruding balcony deck or the like (excluding car parking structures).</p> <p>Note: The front setback is the horizontal distance between the building envelope and the primary street boundary, measured at 90° from the boundary (refer to Figure 2).</p> <p>Note: On corner lots, the shortest frontage to a street is typically where the front setback applies.</p> <p>Note: These controls do not apply to battle-axe lots (refer to Section B3.9).</p>
<p>O4 To ensure that buildings are well articulated and positively contribute to the streetscape.</p>	<p>C2 The building has a maximum unarticulated width of 6m to the street frontage.</p>



**FIGURE 3**

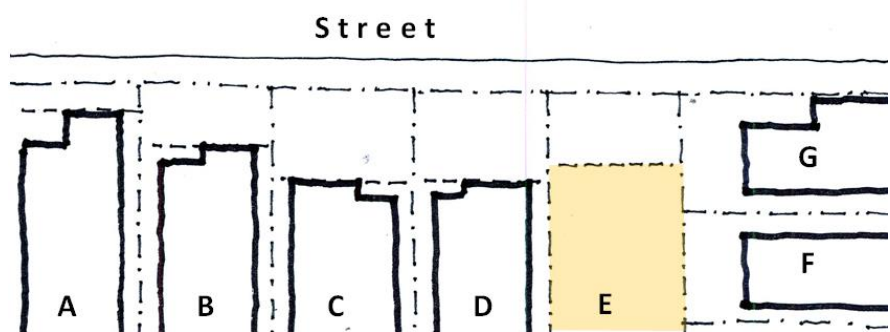
Setbacks of the four closest residential buildings are determined by the distance between the primary street boundary and the outside face of the front building wall, or any protruding balcony deck or the like (excluding car parking structures).



**Example 1**

Setback for **Lot C** = (setback of **A+B+E**) divided by 3

Note: The setback at **Lot D** is the least typical and is not included in the calculation.



**Example 2**

Setback for **Lot E** = (setback of **B+C+D**) divided by 3

Note: The setback at **Lot G** is not included as this lot does not share the same primary street frontage.

**A** is not included as it is the least typical.

## B3.2.3 Side setbacks

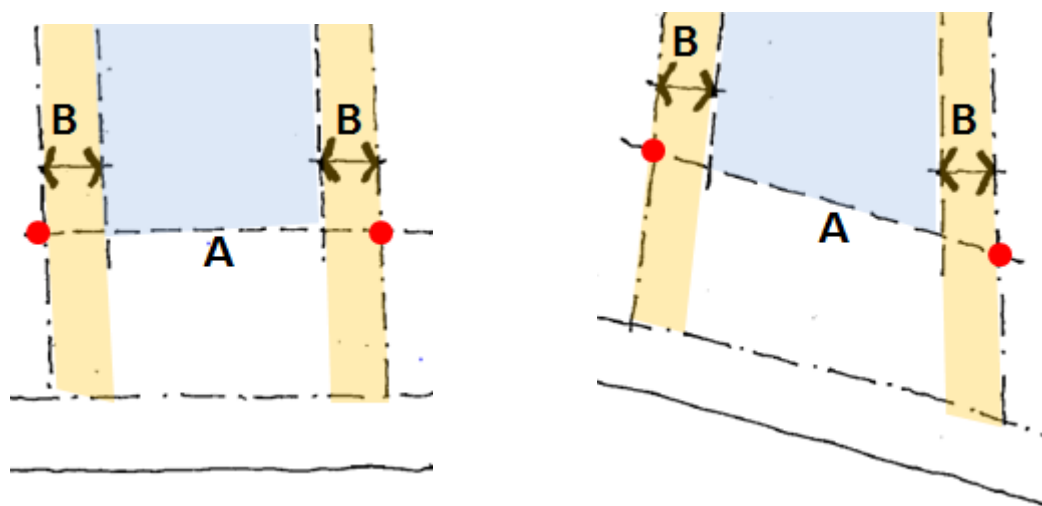
The side setback control seeks to ensure that the distance of a building from its side boundaries protects the amenity of both the neighbours and the proposed development.

The minimum side setback requirement varies according to the lot width and building type.

B3.2 Building envelope ▶ 3.2.3 Side setbacks	
Objectives	Controls
O1 To avoid an unreasonable sense of enclosure and to facilitate an appropriate separation between buildings.	C1 The minimum side setback for dwelling houses, semi-detached dwellings and dual occupancies is determined by the table in Figure 5A.
O2 To ensure the side elevation of buildings are well articulated.	C2 The minimum side setback for residential flat buildings, manor houses, multi dwelling housing, multi dwelling housing (terraces) and attached dwellings is determined by the table in Figure 5B.
O3 To protect the acoustic and visual privacy of residents on neighbouring properties.	C3 The minimum side setback for any other land use not addressed in controls C1 to C2 above is determined by the table in Figure 5B.  Note: The side setback is the horizontal distance between the side property boundary and the building envelope, measured at 90° from the boundary at the front setback, as shown in Figure 4.  Note: For controls C2 and C3 setbacks include any basement piling or similar structured forms
O4 To facilitate solar access to habitable windows of neighbouring properties.	
O5 To facilitate views between buildings.	
O6 To provide opportunities for screen planting.	
O7 To allow external access between the front and rear of the site.	C4 The building has a maximum unarticulated wall length of 12m to the side elevation.  Note: A reduced side setback may be considered where zero or significantly reduced setbacks are characteristic of the immediate streetscape. These streets may be specifically identified in Chapter B1 Residential Precincts or Chapter B2 Neighbourhood HCAs.

B3.2 Building envelope ▶ 3.2.3 Side setbacks	
Objectives	Controls
<p>O8 To recognise built form characteristics of semi-detached dwellings and attached dwellings.</p>	<p>C5 Notwithstanding C1 to C3 above, the following variations apply:</p> <ul style="list-style-type: none"> <li>a) For a semi-detached dwelling—a zero setback applies at the common boundary between the pair of semi-detached dwellings.</li> <li>b) For attached dwellings—a zero setback applies at the common boundary between each dwelling within the development.</li> </ul>

**FIGURE 4**  
Side setback measurement, B depends on A



**FIGURE 5A**

Side setback table for dwelling houses, semi-detached dwellings and dual occupancies

A. Site width measured along front setback line in metres	B. Side setback in metres
< 9.0	0.9
9.0 - < 11.0	1.1
11.0 - < 13.0	1.3
13.0 - < 15.0	1.5
15.0 - < 17.0	1.9
17.0 - < 19.0	2.3
19.0 - < 21.0	2.7
21.0 - < 23.0	3.1
23.0 +	3.4

**FIGURE 5B**

Side setback table for Residential flat buildings, manor houses, multi dwelling housing, multi dwelling housing (terraces) and attached dwellings, and any other land use not addressed in controls C1 to C2 of Section 3.2.3 Side setbacks

A. Site width measured along front setback line in metres	B. Side setback in metres
<18.0	1.5
18.0 - < 21.0	2.0
21.0 - < 28.0	2.5
28.0 - < 35.0	3.0
35.0 +	3.5

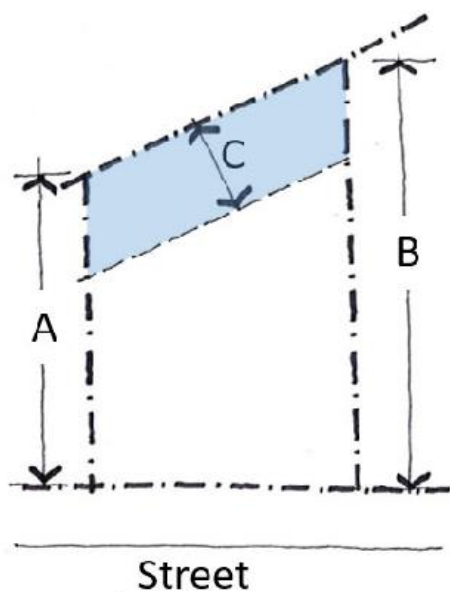
### B3.2.4 Rear setback

The rear setback control seeks to ensure that the distance of a building from its rear boundary provides amenity to both the neighbouring sites and the proposed development. The building (including decks, balconies, entry porches, verandahs, porte-cocheres, undercrofts and the like) must not be located within the rear setback.

In particular, the rear setback provides useable land for private open space and landscaping, which significantly contributes to amenity for the occupants.

The rear setback is the horizontal distance between the building and the rear property boundary.

B3.2 Building envelope ▶ 3.2.4 Rear setback	
Objectives	Controls
O1 To provide private open space and landscaped areas at the rear of buildings.	C1 The minimum rear setback control is 25% of the average of the two side boundary dimensions, measured perpendicular to the rear boundary (see Figure 6). The building must not encroach on the minimum rear setback.
O2 To provide acoustic and visual privacy to adjoining and adjacent buildings.	
O3 To avoid an unreasonable sense of enclosure.	C2 If 'end to end' amalgamation occurs, the building envelope will be determined as if they were separate lots (refer to Figure 7).
O4 To provide separation between buildings to facilitate solar access to private open space.	
O5 To protect vegetation of landscape value and provide for landscaped area and deep soil planting.	
O6 To contribute to a consolidated open space network with adjoining properties to improve natural drainage and support local habitat.	



**FIGURE 6**

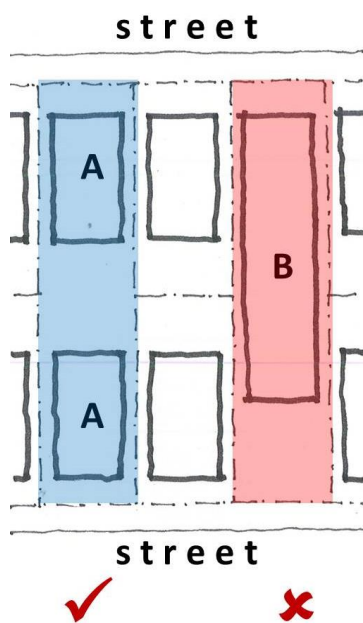
Formula for determining the rear setback

**A** = Side boundary 1

**B** = Side boundary 2

**C** = Rear setback

$$C = (A + B) / 2 \times 25\%$$



**FIGURE 7**

Setbacks for end to end amalgamation

When lots are amalgamated end to end, as illustrated in A and B, the rear setback requirement remains as if it were two lots, as illustrated in A. Not as illustrated in B.

### B3.2.5 Wall height and inclined plane

The wall height control only applies to:

- ▶ development on land in the R2 Low Density Residential Zone; and
- ▶ dwelling houses, semi-detached dwellings and dual occupancies in the R3 Medium Density Residential zone.

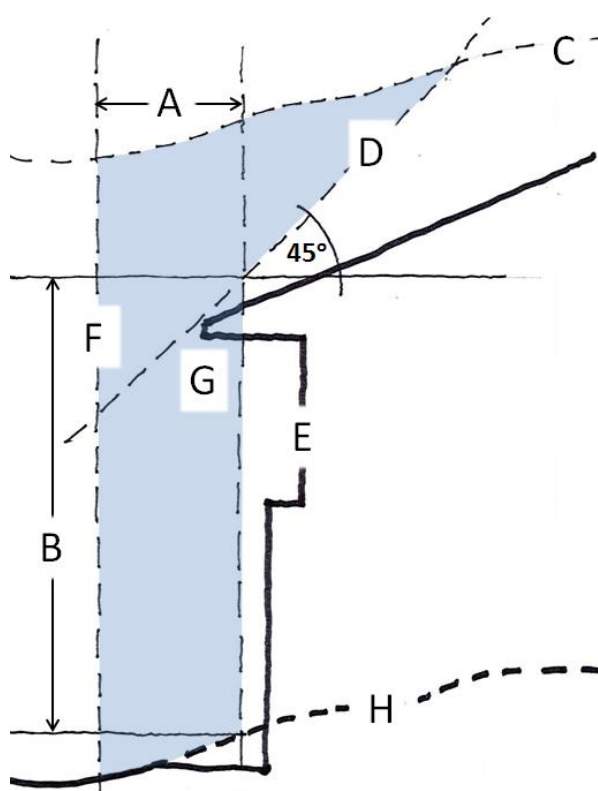
A wall height of 7.2m (accommodating two storeys) and an inclined plane of 45° applies to the front, side and rear elevations. These controls respond to the typical pitched roof house form, but also potentially accommodate three storey flat roof housing forms with a reduced top storey.

B3.2 Building envelope ▶ 3.2.5 Wall height and inclined plane	
Objectives	Controls
O1 To limit the bulk, scale and visual impact of buildings as viewed from the street and from neighbouring properties.	C1 On land zoned R2 Low Density Residential and for a dwelling house, semi-detached dwelling or dual occupancy in the R3 Medium Density Residential zone: <ul style="list-style-type: none"> <li>a) the wall height is 7.2m above existing ground level; and</li> <li>b) an inclined plane is taken from a point 7.2m above existing ground level at each of the setbacks (the inclined plane is at 45 degrees from horizontal); and</li> <li>c) roof eaves may protrude into the setback if below the inclined plane.</li> </ul> Refer to Figure 8.
O2 To limit overshadowing of neighbouring properties across side boundaries.	
O3 To limit overshadowing to south facing rear yards.	
O4 To provide acoustic and visual privacy to adjoining and adjacent buildings.	
O5 To facilitate views between buildings.	
	C2 A variation to the wall height of 7.2m may be considered where the slope of the site within the building envelope is greater than 15 degrees. <p>The variation will only be considered to walls located nearest to the downslope section of the building envelope, i.e. the section with the lowest existing ground level.</p>

**B3.2 Building envelope** ▶ 3.2.5 Wall height and inclined plane**Objectives****Controls**

A request for a variation must demonstrate that the increased wall height is consistent with the objectives of this section of the DCP, consistent with the objectives for development within the zone in which the development is proposed to be carried out, and there are sufficient environmental planning grounds to justify the variation.

Note: The statutory building height control in the Woollahra LEP 2014 applies.

**FIGURE 8**

Section view of the building envelope with the setbacks and inclined plane

**A** = Side setback

**B** = 7.2m maximum wall height

**C** = Maximum building height: 9.5m above existing ground level

**D** = Inclined plane: 45degrees to horizontal

**E** = Potential built form

**F** = Site boundary

**G** = Roof eaves may protrude into the setback if below the inclined plane

**H** = Existing ground level



### B3.3 Floorplate

The floorplate control only applies to:

- ▶ development other than dwelling houses, semi-detached dwellings, secondary dwellings and dual occupancies on land in the R2 Low Density Residential Zone.

#### Floorplate determines amount of development

The development potential for a site is determined by the total floorplate. This is calculated as a percentage of the buildable area.

The **buildable area** is the area of the site that is identified once the front, rear and side setbacks have been established (refer to Figure 9).

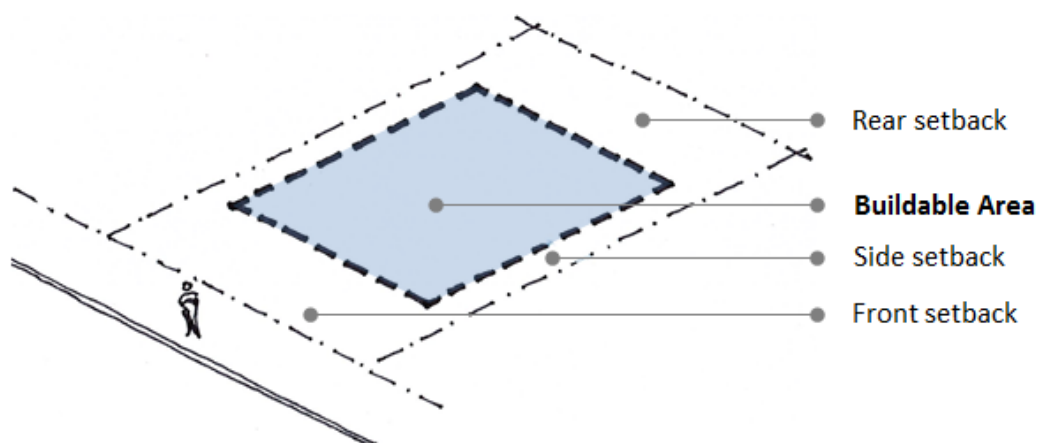
The maximum amount of development permitted on the site is determined by multiplying the buildable area by a factor of 1.65 (165%). This is the maximum permitted total floorplate.

For example if the buildable area is 150m<sup>2</sup> the maximum floorplate yield is:  
 $150\text{m}^2 \times 1.65 = 247.5\text{m}^2$

The floorplate is measured at each level. A level is defined as the space between a floor and a level above. If any part of a level is above 1m above exist ground level that area of the level is counted as floorplate (refer to Figures 10 and 11).

The total floorplate may be distributed over multiple levels, but must be wholly contained within the building envelope.

**FIGURE 9** Buildable area



### Measuring floorplate

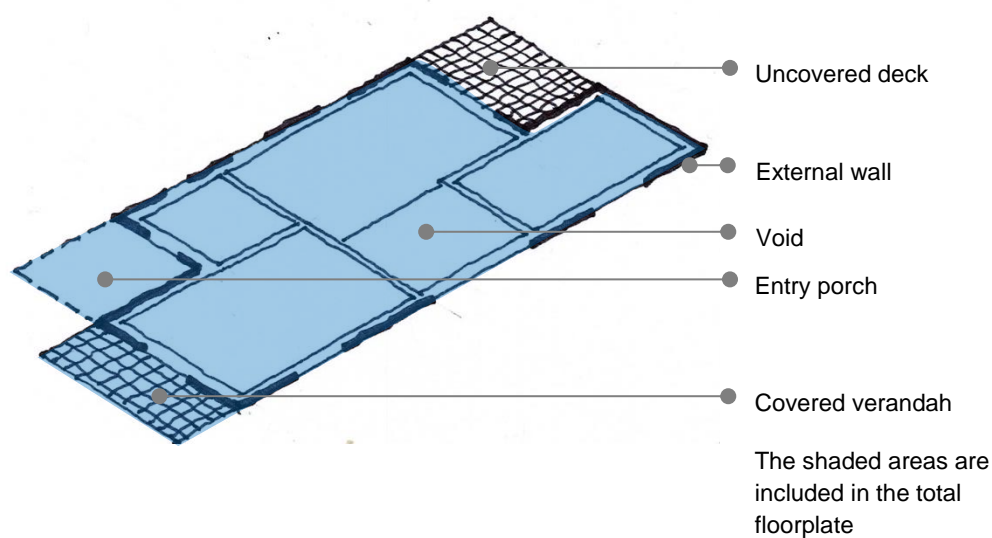
Floorplates are measured to include:

- ▶ the area within the external face of the external walls measured at each level, and
- ▶ the external floorplate which includes covered decks, covered balconies, entry porches, verandahs, porte-cocheres, under crofts and the like (refer to Figures 10 and 11).

but excludes:

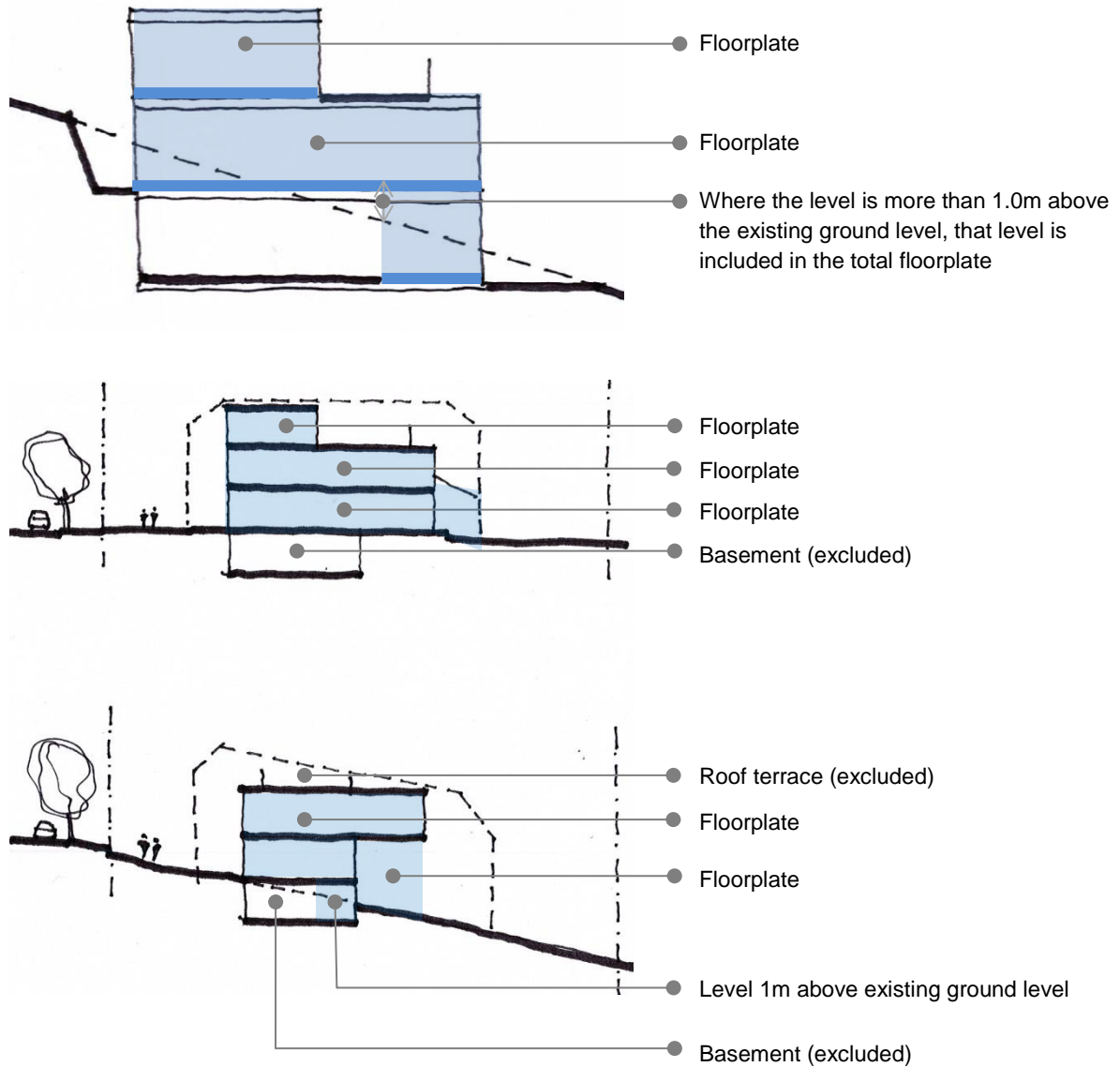
- ▶ uncovered external areas, such as terraces, decks and balconies, and
- ▶ levels below 1m above existing ground level (refer Figure 11)
- ▶ eaves.

**FIGURE 10** Measuring floorplate (aerial view)



**FIGURE 11** Measuring floorplate (section view)

The following examples illustrate elements of the built form that are included in the calculation of the floorplate:

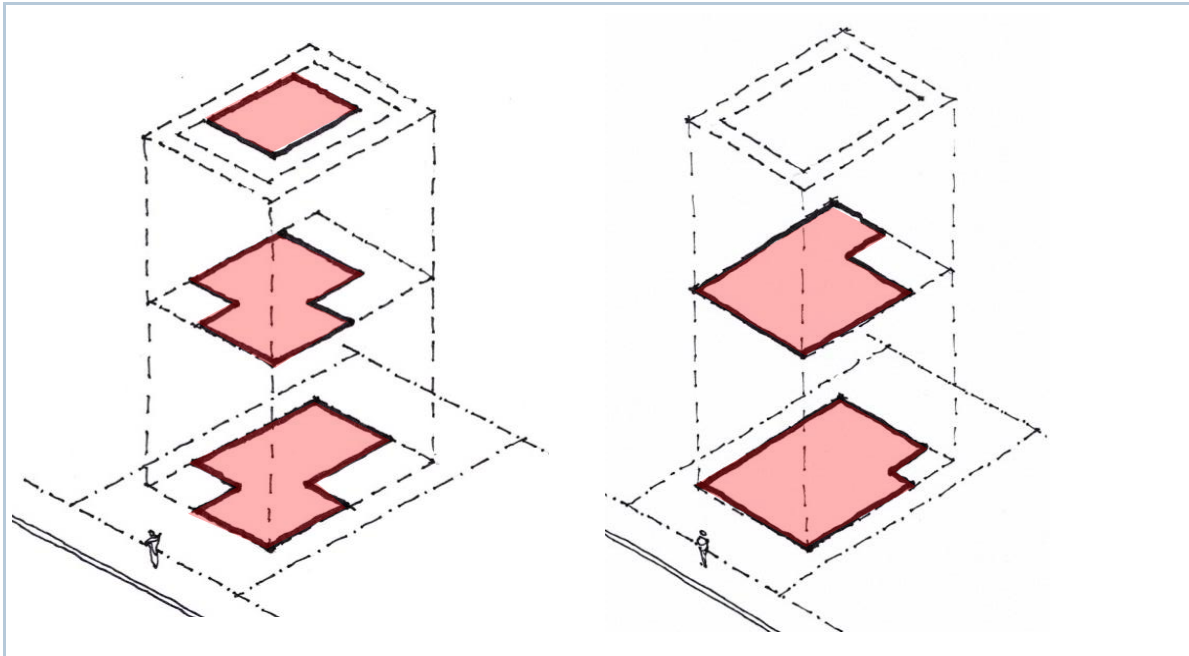


**Applying the floorplate to development**

The proposed development must be located within the building envelope.

The area of the floorplates is calculated at each level of the building. The total area of all floorplates must not be more than 165% of the buildable area.

**FIGURE 12** The same floorplate distributed differently within the same building envelope



B3.3 Floorplates	
Objectives	Controls
O1 To ensure the bulk and scale of buildings are consistent with the desired future character of the area.	C1 The total floorplate of a development does not exceed 165% of the buildable area.
O2 To ensure the size and location of buildings allow for the sharing of views and minimise impact on the privacy and sunlight access to neighbouring properties.	C2. New floorplate is to be wholly within the building envelope with the exception of an outbuilding and parking structures if permitted outside the building envelope (refer to Section 3.6 On-site parking and Section 3.7.4 ancillary development - swimming pools, tennis courts and outbuildings).
	C3 The floorplates at each level are distributed to: <ul style="list-style-type: none"> <li>a) respond to the predominant character of the immediate streetscape;</li> <li>b) retain public views; and</li> </ul>

B3.3 Floorplates	
Objectives	Controls
	<p>c) provide for view sharing of private views.</p> <p>C4 The built form complies with solar access and privacy controls in Section 3.5.2 Overshadowing and Section 3.5.4 Acoustic and visual privacy.</p>
<p>O3 To encourage the design and location of car parking within the building envelope.</p>	<p>C5 Where car parking is provided within the building envelope, the garage area (up to 40m<sup>2</sup>) is added to the permitted total floorplate.</p>

## B3.4 Excavation

Excavation is an accepted part of development in the Woollahra Municipality where the topography varies. Excavation allows buildings on the sloping sites to be designed to step down and sit into the hillside, and it also enables cars and storage to be accommodated on site in an unobtrusive manner.

However, there are significant environmental impacts associated with extensive excavation, as well as external impacts, such as amenity impacts to adjoining properties during the excavation process.

Council has determined that the volume excavated from a given site should be limited to that which might reasonably be required for car parking and domestic storage requirements, and to allow the building to respond to the site topography in an appropriate manner.

B3.4 Excavation	
Objectives	Controls
<p>O1 To set maximum acceptable volumes of excavation which:</p> <ul style="list-style-type: none"> <li>a) require buildings to be designed and sited to relate to the existing topography of the site;</li> <li>b) ensure excavation, including the cumulative impacts of excavation, does not adversely impact land stabilisation, ground water flows and vegetation;</li> <li>c) avoid structural risks to surrounding structures;</li> <li>d) ensure noise, vibration, dust and other amenity impacts to surrounding properties during construction are reasonable;</li> <li>e) enable deep soil planting in required setbacks;</li> <li>f) ensure traffic impacts and impacts on local infrastructure arising from the transfer of excavated material from the development site by heavy vehicles are reasonable; and</li> <li>g) satisfy the principles of ecologically sustainable development (including the energy expended in excavation and transport of material and the relative energy intensity of subterranean areas in dwellings).</li> </ul>	<p>C1 For a dwelling house, dual occupancy or semi-detached dwelling (including attached and detached garaging)—the maximum volume of excavation permitted is no greater than the volume shown in Figure 13A.</p> <p>C2 For a residential flat building, manor houses, multi dwelling housing, multi dwelling housing (terraces), or attached dwelling development (including attached and detached garaging)—the maximum volume of excavation permitted is no greater than the volume shown in Figure 13B.</p> <p>C3 For any other use (including attached and detached garaging) not addressed in C1 and C2 above—the maximum volume of excavation permitted is no greater than the volume shown in Figure 13B.</p> <p>C4 A variation to the volume shown in Figures 13A and 13B will be considered for residential flat buildings only, however the maximum volume of excavation permitted will only be the amount needed to accommodate:</p> <ul style="list-style-type: none"> <li>a) car parking to comply with the maximum rates in Part E1 of this DCP and any reasonable access thereto, if the maximum car parking rates are required by the Council; and</li> </ul>

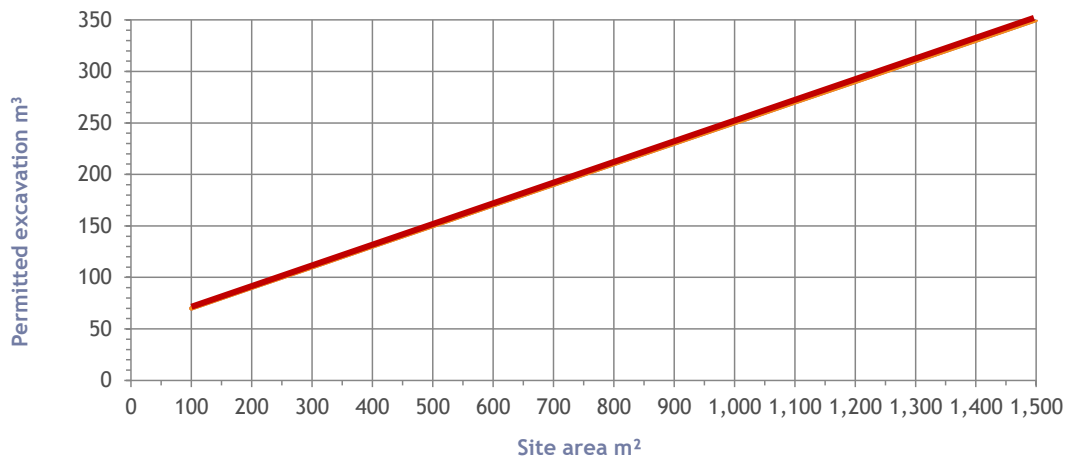
B3.4 Excavation	
Objectives	Controls
	<p>b) storage at a rate of 8m<sup>3</sup> (cubic metres) per dwelling.</p>
	<p>C5 The volume controls in C1 and C2 above do not apply to backyard swimming pools and tennis courts located outside the building envelope. (Note: Separate controls apply which limit excavation, refer to Section 3.7.4 Ancillary development - swimming pools, tennis courts and outbuildings).</p>
	<p>C6 Basement walls and any piling (or similar structural elements) must be no closer to the boundary than permitted by the setback controls (refer to Figure 14).</p>
	<p>C7 Notwithstanding C6, basement walls and any piling (or similar structural elements) for residential flat buildings, manor houses, multi dwellings housing, multi dwelling housing (terraces) and attached dwellings must be no closer to the boundary than 1.5m (see Figure 15).</p>
	<p>C8 Excavation in relation to an existing attached dwelling, semi-detached dwelling, or attached dual occupancy is not to occur under:</p> <ul style="list-style-type: none"> <li>a) common party walls;</li> <li>b) footings to common party wall;</li> <li>c) freestanding boundary walls;</li> <li>d) footings to freestanding boundary walls.</li> </ul>
	<p>C9 Excavation below 2m or within 1.5m of the boundary must be accompanied by a geotechnical and hydrogeological report and a structural report demonstrating that the works will not have any adverse effect on surrounding structures.</p> <p>Note: Council may identify other circumstances where these reports are required. All reports must be prepared in accordance with Council’s guidelines. As a condition of a development consent, Council will require the preparation and submission of a dilapidation report for</p>

B3.4 Excavation	
Objectives	Controls
	properties neighbouring the development and the use of vibration monitoring devices during construction, unless the applicant is able to demonstrate that these are not required.

**FIGURE 13A**

Maximum volume of excavation for the site of:

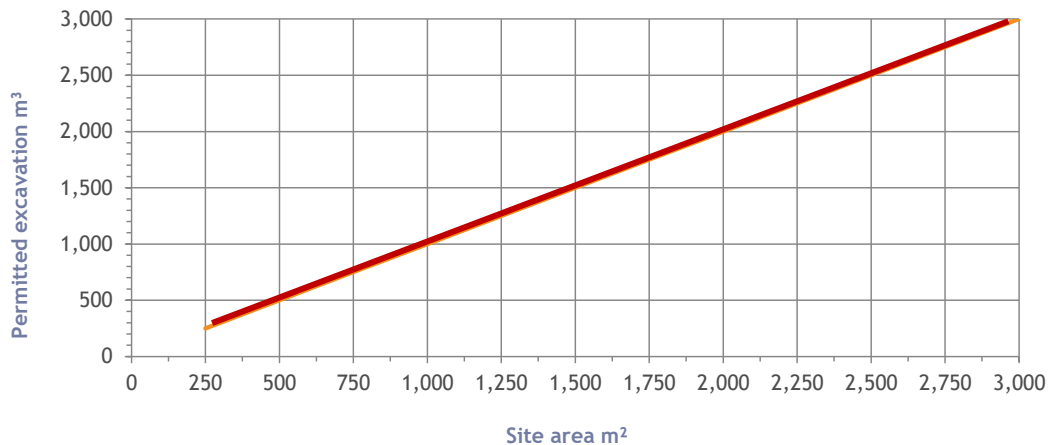
- a dwelling house
- dual occupancy development
- a semi-detached dwelling



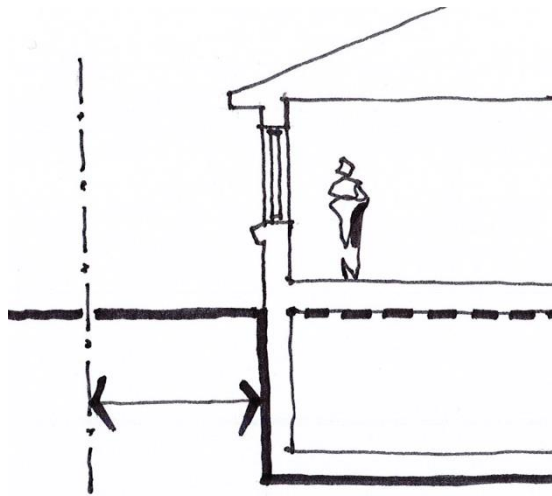
**FIGURE 13B**

Maximum volume of excavation for the site of:

- a residential flat building
- manor houses
- multi dwelling housing
- multi dwelling housing (terraces)
- attached dwellings
- any other land use not addressed in controls C1 to C2 of Section B3.4 Excavation

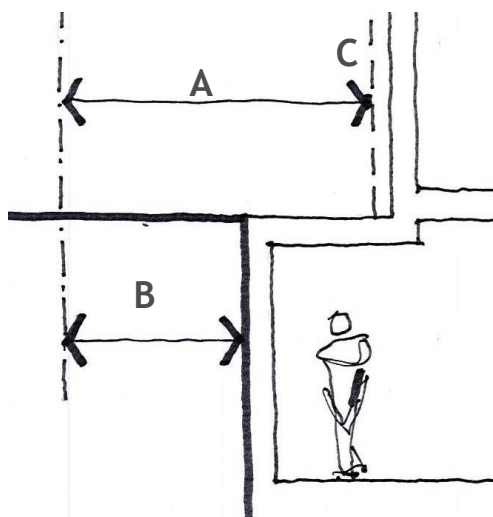






**FIGURE 14**

For a dwelling house, dual occupancy development and semi-detached dwellings basement walls and any piling (or similar structural elements) can be no closer to the boundary than the required setback (refer to Figure 5).



**FIGURE 15**

For a residential flat building, manor houses, multi dwelling housing, multi dwelling housing (terraces), attached dwellings and any other land use not addressed in controls C1 to C2 of Section B3.4 Excavation, basement walls and any piling (or similar structural elements) can be no closer to the boundary than 1.5m.

**A-** Refer Figure 6

**B-** Minimum excavation setback 1.5m

**C-** Building envelope

## B3.5 Built form and context

### B3.5.1 Streetscape and local character

A quality streetscape provides good public amenity and contributes to the character and identity of the locality. As character can vary from street to street, it is important that development recognises predominant streetscape qualities, such as building form to ensure a cohesive streetscape character.

#### B3.5 Built form and context ▶ 3.5.1 Streetscape character

Objectives	Controls
O1 To ensure that the built form is compatible with the streetscape and the desired future character of the area.	C1 The building is consistent with the desired future character of the area set out in the precinct controls in Parts B1 and B2 of this DCP.
O2 To ensure that development is of high visual quality and enhances the street.	Note: Chapters B1 and B2 in this part of the DCP define the desired future character for each precinct or HCA, and identify special streetscape character, heritage and key elements within each precinct.
O3 To ensure that development contributes towards reducing the urban heat island effect by encouraging urban greening and retaining, protecting and enhancing tree canopy cover.	C2 Development retains vegetation of landscape value.
O4 To maintain the evolution of residential building styles through the introduction of well-designed contemporary buildings.	C3 Development steps down sloping sites and follows the topography of the land.
	C4 Development minimises disturbance and adverse impacts on existing canopy trees which are to be retained.
	C5 External building materials and colours do not detract from the streetscape. Bright or obtrusive colour schemes are avoided.
	C6 Roof forms and roof structures (including roof terraces, lifts, lift overruns, stairwells, access hatches, and other like structures) are well-designed, contribute positively to the streetscape, and are well-integrated with the architecture of the building.
	C7 The use of reflective materials is minimal (including windows, access hatches, skylights and balustrades).
O5 To ensure that roof forms are consistent with the existing	C8 In heritage conservation areas or where the existing immediate streetscape is

**B3.5 Built form and context ▶ 3.5.1 Streetscape character**

Objectives		Controls	
	predominant roof forms in the street and minimise impacts to neighbouring properties.		<p>predominantly characterised by pitched roof forms, new development incorporates pitched roof forms.</p> <p>C9 Roof materials are non-reflective and do not cause excessive glare to adjacent properties.</p>
O6	To ensure buildings improve the safety of the public domain.	C10	The building addresses the street and provides opportunities for casual surveillance. At least one habitable room window overlooks the street.

## B3.5.2 Overshadowing

Building bulk should be distributed to minimise overshadowing to neighbouring properties.

Development is to be sited and designed to maximise midwinter solar access to neighbouring properties, having regard to slope, views and existing vegetation.

B3.5 Built form and context ▶ 3.5.2 Overshadowing	
Objectives	Controls
O1 To minimise overshadowing to neighbouring properties.	<p>C1 The development is designed so that:</p> <ul style="list-style-type: none"> <li>a) sunlight is provided to at least 50% (or 35m<sup>2</sup> with a minimum dimension of 2.5m, whichever is the lesser) of the main ground level private open space of adjacent properties for a minimum of 2 hours between 9am and 3pm on 21 June. Where existing overshadowing is greater than this, sunlight is not further reduced; and</li> <li>b) north facing windows to upper level habitable rooms of adjacent dwellings receive at least 3 hours of sun between 9am and 3pm on 21 June over a portion of their surface.</li> </ul> <p>C2 Lot orientation may make C1 above difficult to achieve so a reduced amount of solar access may be considered, provided the proposed building complies with all setback controls.</p> <p>Note: For land adjoining open space also refer to Section 3.10.1.</p>

### B3.5.3 Public and private views

Views are a special element of Woollahra's unique character. The sloping topography, leafy setting and harbour frontage combine to offer dramatic bushland and water views which contribute to the amenity of both private dwellings and the public domain.

In addition, the municipality's frontage to Sydney Harbour places responsibilities upon the Woollahra community, to ensure development maintains the scenic beauty of the foreshore and headland areas when viewed from the water and from the land.

#### Public views

Public views from streets, footpaths, parks and other public areas are among Woollahra's most prized assets and are key elements of the municipality's identity.

These views may take the form of discrete views between buildings and vegetation, more open views across the harbour and local landscape from public parks, or more defined vistas along streets terminating at Sydney Harbour or local landmarks. Important views and vistas are identified on the precinct maps in Chapters B1 and B2 in this part of the DCP.

The preservation and, wherever possible, enhancement of public views helps to maintain legibility within Woollahra by allowing people to see and interpret the surrounding landscape and landmark features. Public views also allow Woollahra's scenic beauty and special character to be appreciated.

#### Private views

View sharing concerns the equitable distribution of views between properties. The view sharing controls in this DCP seek to strike a balance between accommodating new development while providing, where practical, reasonable access to views from surrounding properties.

Development should be designed to reflect the view sharing principles in *Tenacity Consulting v Warringah Council [2004] NSWLEC 140*.

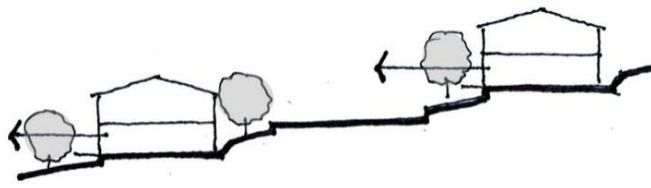
B3.5 Built form and context ▶ 3.5.3 Public and private views			
Objectives		Controls	
O1	To protect and enhance existing views and vistas from the public domain.	C1	Development is sited and designed so that the following public views are maintained or enhanced:  a) significant views and vistas identified in the precinct maps in this Chapter B1 Residential Precincts and Chapter B2 Neighbourhood HCAs of this DCP; and
O2	To provide additional views and vistas from streets and other public spaces where opportunities arise.		

**B3.5 Built form and context** ▶ 3.5.3 *Public and private views*

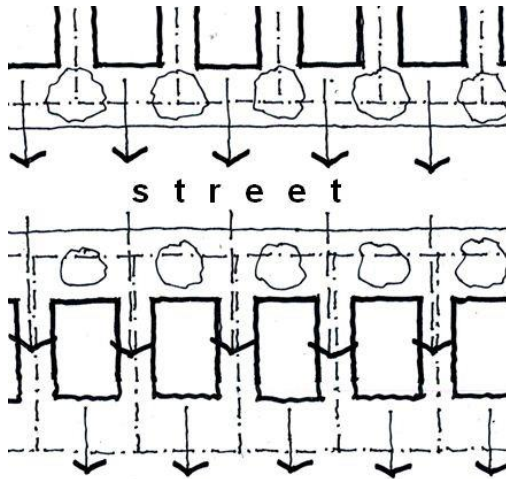
Objectives	Controls
	<p>b) views from other public open space areas, particularly from ridgelines to Sydney Harbour and the Sydney CBD skyline.</p> <p>C2 Vistas along streets are preserved or enhanced through sensitive development location and form.</p> <p>C3 Development on the low side of the street preserves district, iconic and harbour views from the street by:</p> <p>a) providing substantial breaks between buildings, front fences, car parking and other structures; and</p> <p>b) incorporating fences with transparent or open end panels at each side boundary to provide for views.</p> <p>C4 Roof forms on the low side of streets are designed to allow public views and add interest to the scenic outlook. Flat expansive roofs with vents, air conditioning units, plant equipment (including lifts and lift overruns) and similar structures are inappropriate.</p>
<p>O3 To encourage view sharing as a means of ensuring equitable access to views from private property.</p>	<p>C5 Development is sited and designed to enable a sharing of views with surrounding private properties, particularly from the habitable rooms (refer to Figures 16 and 17).</p> <p>C6 Development steps down the hillside on a sloping site.</p> <p>C7 The design of the roof form (including roof terraces, lifts, lift overruns, stairwells, access hatches, screens, and other like structures) provides for view sharing.</p>

**B3.5 Built form and context** ▶ 3.5.3 *Public and private views*

Objectives	Controls
	<p>C8 Roof terraces are uncovered to provide for view sharing. All elements on roof terraces are to comply with the maximum building height control.</p> <p>Note: Access to roofs should not comprise visually prominent stand-alone structures such as lifts or large stairways, particularly on flat roofs.</p>
<p>O4 To ensure that views are not unreasonably compromised by landscaping.</p>	<p>C9 The location and species of new tree planting frames and preserves public and private views. Planting must not be used to moderately, severely or devastatingly block views in accordance with the Tenacity Land and Environment Court Principle.</p> <p>C10 In sloping areas, the location of new tree planting frames and preserves public views. This may be achieved:</p> <ul style="list-style-type: none"> <li>a) on the high side of streets—by concentrating new tree planting at the front of buildings within the side setbacks; and</li> <li>b) on the low side of streets—by concentrating new tree planting at the front of buildings outside the side setbacks (refer to Figure 17).</li> </ul>



**FIGURE 16**  
View sharing



**FIGURE 17**  
Where to locate vegetation to  
accommodate view paths



---

## B3.5.4 Acoustic and visual privacy

---

Privacy refers to both acoustic and visual privacy. The privacy needs of residents and neighbours should influence all stages of design, from the location of buildings and the placement of windows and private open space through to the selection of materials and construction techniques.

This section contains objectives and controls for acoustic and visual privacy for buildings that have the potential to impact on adjoining and adjacent residential development.

It is important to note however, that privacy issues are an inherent component of urban living. In many cases some degree of mutual overlooking and/or noise from property to property is unavoidable.

### Acoustic privacy

The level of acoustic privacy depends upon the location of habitable rooms relative to noise sources such as habitable rooms, decks, terraces, driveways, air conditioning units, swimming pool pumps and major roads.

Dwellings are designed to ensure adequate acoustic separation and privacy to the occupants of all dwellings. This may be achieved by:

- ▶ ensuring that bedrooms of one dwelling do not share walls with the habitable rooms (excluding bedrooms) or parking areas of the adjacent dwelling;
- ▶ locating bedroom windows at least 3m from streets, shared driveways and parking areas of other dwellings; and
- ▶ separating bedrooms, by way of barriers or distance, from on-site noise sources such as active recreation areas, car parking area, vehicle accessways and service equipment areas.

### Visual privacy

The visual privacy controls apply to habitable rooms. This includes rooms such as a bedroom, living room, lounge room, kitchen, dining room and the like. Maintaining visual privacy within and from these types of habitable rooms is most important, as these are the common living areas in a dwelling. The controls also address the private open spaces of dwellings.

The controls establish a hierarchical framework for addressing privacy and overlooking. In this hierarchy glazed fixed windows and windows with high sills are the least preferred option and should only be considered in limited circumstances when all other options have been exhausted.

Note:

- ▶ Under the BCA, habitable rooms exclude a bathroom, laundry hallway, lobby, and other like spaces of a specialised nature occupied neither frequently nor for extended periods.
- ▶ Nothing in this section restricts a person from replacing a window with another window, where the replacement window is in the same location and of the same or a smaller size.

B3.5 Built form and context ▶ 3.5.4 Acoustic and visual privacy	
Objectives	Controls
O1 To ensure adequate acoustic privacy for occupants and neighbours.	<p>C1 Dwellings are designed to ensure adequate acoustic separation and privacy to the occupants of all dwellings.</p> <p>C2 Dwellings located close to high noise sources, such as a busy road or railway line are to:</p> <ul style="list-style-type: none"> <li>a) be designed to locate habitable rooms and private open space away from the noise source; and</li> <li>b) include sound attenuation measures, such as acoustic glazing and insulation.</li> </ul> <p>Note: Shared walls and floors between dwellings must be designed in accordance with the sound transmission and insulation criteria of the Building Code of Australia.</p> <p>C3 Electrical, mechanical, hydraulic and air conditioning equipment is housed so that it does not create an ‘offensive noise’ as defined in the Protection of the <i>Environment Operations Act 1997</i> either within or at the boundaries of any property at any time of the day.</p>
O2 To ensure adequate visual privacy for occupants and neighbours while balancing the need to provide for reasonable levels of environmental amenity, including access to sunlight and ventilation, and good architectural outcomes.	<p>C4 New windows in habitable rooms are designed to prevent a direct sightline to the habitable room windows or private open space of an adjacent dwelling within 9m.</p> <p>This may be achieved by options including, but not limited to (in order of preference):</p> <ul style="list-style-type: none"> <li>a) Window location—primary windows to habitable rooms are located and designed to provide an outlook to the front and rear setbacks, not the side boundaries.</li> <li>b) Layout and separation—offsetting windows from the windows/private open spaces of the adjoining dwelling to limit views between the windows/private open space.</li> <li>c) Architectural design solutions and devices—redirecting and limiting sightlines using deep sills with planter</li> </ul>

**B3.5 Built form and context** ▶ 3.5.4 *Acoustic and visual privacy*

**Objectives**

**Controls**

boxes, fixed horizontal or vertical louvres, or other screening devices set off the windows internally or externally.

d) Glazed opening windows—using windows with translucent glazing to a height of 1.5m above floor level and fitted with a winder mechanism to control the maximum angle of the opening to limit views.

e) Glazed fixed windows or high sills—using fixed windows with translucent glazing in any part of the window below 1.5m above floor level, or window sill heights of 1.5m above floor level.

Note: Applicants may be required to demonstrate how privacy impacts are resolved by way of view line diagrams, photographs and other suitable means.

C5 Windows to bathrooms and toilet areas have translucent glazing where these have a direct view to, and from, habitable rooms and private open space on adjoining and adjacent properties.

C6 Architectural design solutions and screening devices referred to in C4 (c) above are integrated with the overall design and contribute to the architectural merit of the building, having particular regard to:

a) aesthetics of the building including impacts on visual bulk;

b) compliance with minimum boundary setback controls;

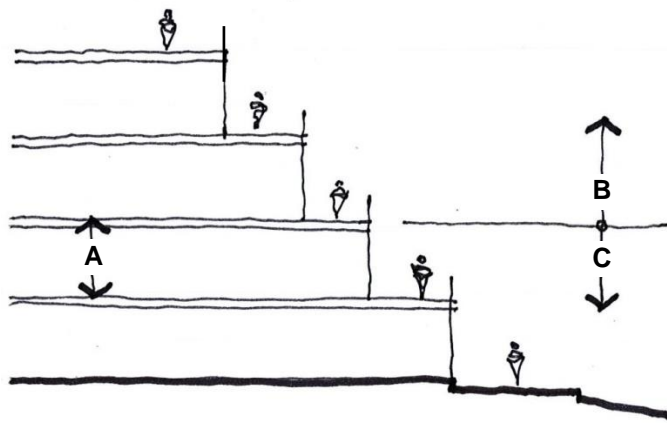
c) appearance from neighbouring properties; and

d) views from adjoining or adjacent properties.

**B3.5 Built form and context** ▶ 3.5.4 Acoustic and visual privacy

Objectives	Controls
<p>O3 To minimise the impacts of private open space.</p>	<p>C7 Private open spaces and the trafficable area of roof terraces (at or below the second storey) (refer to Figure 18) are to be suitably located and screened to prevent direct views to neighbouring:</p> <ul style="list-style-type: none"> <li>a) habitable rooms (including bedrooms) within 9m; and</li> <li>b) private open space within 9m.</li> </ul> <p>Note: Private open space includes an area external to a building including land, terrace, balcony or deck.</p> <p>C8 For a dwelling house, dual occupancy, semi-detached dwelling, or attached dwelling—the acceptability of any elevated balcony, deck, or terrace will depend on the extent of its impact, its reasonableness and its necessity.</p> <p>Note: Refer to <i>Super Studio vs Waverley Council, (2004) NSWLEC 91</i></p> <p>C9 Windows and balconies of an upper-level dwelling are designed to prevent overlooking of the private open space of a dwelling below within the same development.</p> <p>C10 The trafficable area of a roof terrace (above the second storey) (refer to Figure 18) is setback so that there is no direct line of sight, from that part of the building where the terrace or deck is, to:</p> <ul style="list-style-type: none"> <li>a) neighbouring private open space within 12m; or</li> <li>b) windows of habitable rooms in neighbouring dwellings within 12m.</li> </ul>

B3.5 Built form and context ▶ 3.5.4 Acoustic and visual privacy	
Objectives	Controls
	<p>C11 Lighting installations on a roof terrace or upper level deck are:</p> <ul style="list-style-type: none"> <li>a) contained within the roof terrace area and located at a low level; or</li> <li>b) appropriately shaded and fixed in a position so light is projected downwards onto the floor surface of the terrace.</li> </ul> <p>Note: Lighting of roof terraces must be designed in compliance with <i>Australian Standards 4282-1997 Control of obtrusive effects of outdoor lighting</i>.</p>
<p>O4 To ensure that where roof terraces are inserted into roofs, they do not impact on the roof profile.</p>	<p>C12 For a roof terrace within the roof a building:</p> <ul style="list-style-type: none"> <li>a) no part of the roof terrace or associated structures, such as a balustrade, projects beyond the roof profile; and</li> <li>b) the roof terrace and opening within the roof are clearly subservient in form and size when compared with the roof plane in which they are located.</li> </ul> <p>Note: Screening to roof terraces will only be considered where the screening is consistent with the streetscape and will have no impact on views or overshadowing of neighbouring properties.</p>



**FIGURE 18**  
Application of the visual privacy controls to roof terraces

- A** - Second storey
- B** - Refer to B3.5.4 C10
- C** - Refer to B3.5.4 C7

### B3.5.5 Internal amenity

Solar and daylight access and natural ventilation are important for providing pleasant and healthy indoor environments for people to live. This is particularly important for designing comfortable habitable rooms and other areas that are occupied for extended periods.

Provision of natural light and ventilation reduces the reliance on artificial lighting, heating, air-conditioning and mechanical ventilation. This improves energy efficiency and residential amenity.

Note: Habitable rooms exclude bathrooms, corridors, hallways, stairways, lobbies, and other like spaces of a specialised nature occupied neither frequently nor for extended periods.

**B3.5 Built form and context** ▶ 3.5.5 Internal amenity

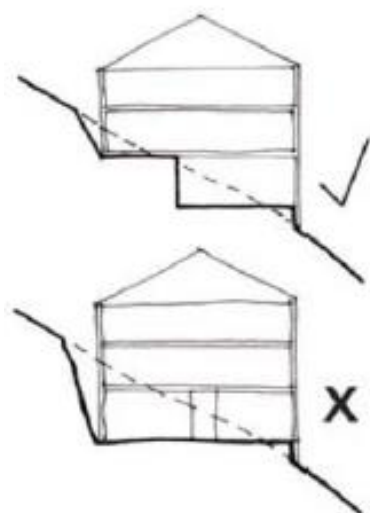
**Objectives**

**Controls**

<p>O1 To encourage high levels of internal amenity through the provision of direct natural light and direct natural ventilation.</p> <p>O2 To encourage buildings that are designed to maximise natural light provision in habitable rooms.</p>	<p>C1 All habitable rooms in a dwelling must have at least one external wall primarily above the existing ground level which provides an unobstructed window opening,</p> <p>C2 All habitable rooms and sanitary compartments in a dwelling must have direct natural light and direct natural ventilation,</p> <p>C3 The area of unobstructed window openings should be equal to at least 20% of the room floor area for habitable rooms,</p>
---	---

**B3.5 Built form and context** ▶ 3.5.5 Internal amenity

Objectives	Controls
	<p>C4 Light wells must not be the primary air source for habitable rooms, and</p> <p>C5 Any room of a dwelling either partially or fully below existing ground level (excluding basement parking and storage areas) is limited to a maximum room depth of 2 X the ceiling height.</p>



**FIGURE 18A**  
Dwellings should be designed to locate rooms primarily above existing ground level to maximise the provision of natural light from unobstructed window openings.

## B3.6 On-site parking

On-site parking, including garages, carport, hardstand areas and driveways, must be carefully designed to not detract from the appearance of the development and the streetscape.

In particular, on-site parking should not dominate the street frontage, and driveway openings should be limited to protect pedestrian safety and to preserve streetscape amenity such as trees and on-street parking. On-site parking should also be designed to limit the extent of impervious surfaces and excavation and to allow landscaped area in the front setback.

Note: The number of on-site parking spaces for a development is set out in Part E, Chapter E1 Parking and Access.

B3.6 On-site parking	
Objectives	Controls
O1 To minimise the visual impact of garages, car parking structures and driveways on the streetscape.	C1 On-site parking is designed and located so that it: <ul style="list-style-type: none"> <li>c) is located within the building envelope;</li> <li>d) does not dominate the street frontage; and</li> <li>e) preserves trees and vegetation of landscape value.</li> </ul>
O2 To ensure that on-site parking does not detract from the streetscape character and amenity.	
O3 To allow, in certain circumstances, parking structures outside the building envelope.	
O4 To minimise loss of on-street parking.	
O5 To retain trees and vegetation of landscape value.	
	C2 Notwithstanding C1, parking structures are permitted outside the building envelope but only where: <ul style="list-style-type: none"> <li>a) there is rear access (via a lane or street); or</li> <li>b) the site is located on sloping land where:               <ul style="list-style-type: none"> <li>• the rise or fall measured to a distance of 7m from the street frontage is greater than 1 in 3 (refer to Figure 19A); and</li> <li>• the car parking structure is incorporated into a podium or street wall; and</li> <li>• the car parking structure is not more than 40m<sup>2</sup> in area.</li> </ul> </li> </ul>
	c) the existing streetscape in the immediate vicinity of the site is characterised by



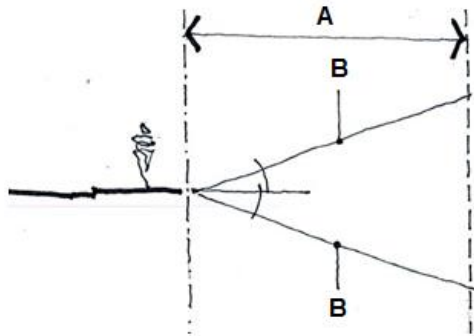
B3.6 On-site parking	
Objectives	Controls
	<p>parking structures forward of the building line and</p> <ul style="list-style-type: none"> <li>• For separate structures, the roof form, materials and detailing complement the principal building</li> <li>• Garage doors are designed to complement the building design and any important character elements within the street.</li> </ul>
	<p>C3 Parking structures outside the building envelope are only permitted when:</p> <ul style="list-style-type: none"> <li>a) minimum deep soil landscaped area and private open space requirements are met, as set out in Section 3.7.1 Landscaped areas and private open space; and</li> <li>b) solar, access and privacy requirements within the site, and to the neighbouring properties, are met as set out in Section 3.5.2 Overshadowing and Section 3.5.4</li> </ul>
	<p>C4 For car parking structures facing the street frontage– the maximum car parking structures width is no greater than 40% of the site frontage width or 6m, whichever is the lesser.</p>
	<p>C5 Where possible on-site parking is to be accessed from the rear. The width of parking structures can occupy 75% of the rear frontage or 6m (whichever is the lesser). The site area of the parking structure can be no greater than 40m<sup>2</sup> and the height a maximum of 3.6m.</p>
	<p>C6 Development involving three or more dwellings provides basement parking.</p>

B3.6 On-site parking	
Objectives	Controls
<p>O6 To facilitate on-site parking on steeply sloping sites.</p> <p>O7 To ensure that on-site parking is designed and integrated with the principal building on the site.</p> <p>O8 To ensure that on-site parking does not detract from the streetscape character and amenity.</p>	<p>C7 For car parking structures located in the front setback, the maximum height of the structure is 2.7m above the footpath level. If the existing height of the retaining/street wall or the two adjoining car parking structures is higher than 2.7m, that greater height may be permitted (refer to Figure 19B).</p> <p>C8 For car parking structures on the high side of the street—balustrading to trafficable areas on top of the structure is setback at least 1m from the front boundary, and is of an open or transparent form (refer to Figure 19B).</p>
<p>O9 To minimise the visual and environmental impacts of driveways and other hard stand areas associated with car parking.</p>	<p>C9 The width of driveways is minimised. Generally the width is no more than the minimum width required to comply with the relevant Australian Standards (see Section E1).</p> <p>C10 Only one driveway entrance is provided. For example, development involving more than one dwelling shares the driveway access.</p> <p>C11 Where soil and drainage conditions allow, semi-porous surfaces are used for uncovered car parking and driveway areas to facilitate on-site stormwater infiltration and reduce limit the visual impact of hard-surface areas.</p>

**FIGURE 19A**

Car parking structures in front setback

On sites where the gradient measured to a distance of 7m (A) from the street frontage is greater than 1 in 3 (B), Council may permit car parking structures forward of the building line if incorporated into a podium/street wall.

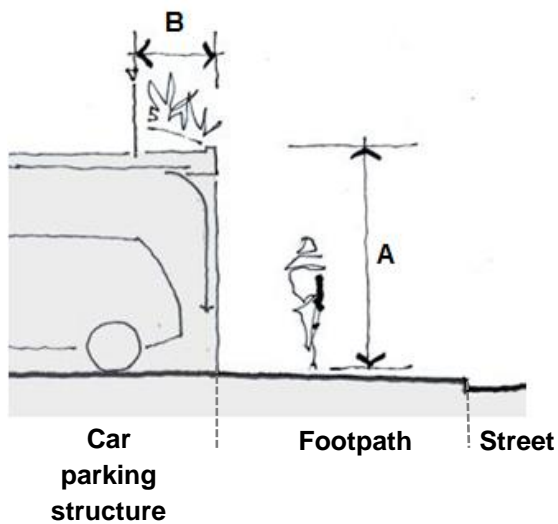


**FIGURE 19B**

Car parking structures at front boundary

**A** = The car parking structure's height at the front boundary is to be no more than 2.7m above the pavement

**B** = Any balustrading on the car parking structure is to be set back 1m



## B3.7 External areas

### B3.7.1 Landscaped areas and private open space

Open space and landscaping play important roles in the preservation of wildlife habitat, the establishment of community identity, the provision of recreation opportunities and stormwater management.

#### Urban greening and tree canopy

Urban heat island effect is localised warming caused by a lack of vegetation and large areas of impervious surfaces like roads, car parks and buildings.

Higher air pollution, reduced night-time cooling, and increased temperatures are outcomes of urban heat island effect that can adversely affect human health.

Urban greening is the integration of vegetation into development to decrease the urban heat island effect, improve microclimates and enhance mental and physical wellbeing.

Urban greening reduces local temperatures by encouraging evaporation from the soil and plants into the urban environment.

Trees and in particular canopy trees, are critical in mitigating localised warming and provide a number of environmental, social and economic benefits. Benefits include filtering air and water pollutants, slowing and storing stormwater runoff, providing shade and shelter, supporting biodiversity and improving amenity.

Trees also create a sense of place and are fundamental to our leafy streetscapes and the desired future character of our residential precincts. Enhancing tree canopy cover is an important component in mitigating climate change and resilience for sustainable, liveable neighbourhoods.

For the purposes of calculating tree canopy area on a site, the following definitions apply: A tree crown is the total amount of foliage supported by the branches of an individual tree.

Tree canopy area is the part of the site covered by the combined lateral spread of tree crowns of all trees above 3 metres in height and spread (Refer Figure 20).

Existing overhanging tree canopy from the street or neighbouring site/s can be included in the calculation of tree canopy area on the subject site.

A canopy tree is a tree that attains a minimum height of 8 metres and minimum crown diameter of 8 metres at maturity, and is planted in a deep soil landscaped area with a minimum dimension of 4 metres (Refer Figure 21 for calculation of deep soil landscaped area).

Selection of trees must take into consideration the impact on amenity and views on the subject site and neighbouring site/s. Trees selected should be capable of achieving the applicable tree canopy area for the site within 5-10 years of completion of the development.

DA Guide: A range of tree species with their individual deep soil area requirements is listed in the DA Guide.

### Private open space

Private open space contributes towards the amenity of individual dwellings and should be clearly delineated from public and communal areas. Private open space may be provided at or above ground level. Above ground open space may comprise balconies or rooftop areas.

### Communal open space

Communal open space comprises shared open space available for use by all residents of a housing development. Communal open space may include landscaped areas, swimming pools or tennis courts and is typically controlled by a body corporate.

### Landscaping

Landscaped area is defined in Woollahra LEP 2014 to mean “a part of a site used for growing plants, grasses and trees, but does not include any building, structure or hard paved area”.

Deep soil landscaped area is the part of a site that contains landscaped area which has no above ground, ground level or subterranean development.

Landscaped areas within developments may comprise both communal and private open space areas. Landscape treatment helps to determine the amenity of individual dwellings, define private and public areas, reinforce or screen views and define streetscape character.

The amount and composition of landscaped area also plays an important role in stormwater management, the energy efficiency of developments and access to sunlight. Existing trees and vegetation may support significant indigenous wildlife populations and habitat.

B3.7 External areas ► 3.7.1 Landscaped area and private open space	
Objectives	Controls
O1 To ensure that the areas outside the building contribute to the desired future character of the location.	These controls apply to development in the R2 and R3 residential zones that alter the existing building footprint and/or building envelope and/or impacts upon existing landscapes (refer DA Guide)
O2 To provide sufficient deep soil landscaped area to encourage urban greening and maintain and enhance tree canopy cover which in turn contributes positively to the existing and desired future character of the locality.	
O3 To provide for on-site stormwater absorption.	
	<p>C1 Tree canopy area is at least:</p> <ul style="list-style-type: none"> <li>a) 35% of the site area for dwelling houses, dual occupancies, semi-detached development and attached dwellings, with the exception of the Wolseley Road area, or</li> <li>b) 30% of the site area for residential development other than dwelling houses, dual occupancies, semi-detached development and attached dwellings, or</li> </ul>

**B3.7 External areas ▶ 3.7.1 Landscaped area and private open space****Objectives****Controls**

- c) 25% of the site area for all residential development in the Wolseley Road area (Figure 22)

And at least half of the total tree canopy area on the site is contributed by canopy tree/s.

Refer Figure 20 for the calculation of tree canopy area.

Council may consider a variation to this control where:

- a) Council is satisfied that a canopy tree will have a moderate, severe or devastating impact on views when assessed in accordance with the Tenacity Land and Environment Court Planning Principle. (Note: This control will prevail over view sharing objectives and controls where view impacts are negligible or minor when assessed in accordance with the Tenacity Land and Environment Court Planning Principle).
- b) The applicant has demonstrated that the deep soil landscaped area on the subject site is unable to achieve the minimum tree canopy area from canopy trees due to the site conditions such as geology, topography, configuration or built form. (Note: The applicant must satisfy Council that a skilful design has been considered to achieve the development potential and amenity and reduce the impact on deep soil landscaped area).

C2 35% of the site area is deep soil landscaped area with the exception of the Wolseley Road area (Figure 22) where 30% of the site area is deep soil landscaped area. Refer Figure 21 for the calculation of deep soil landscaped area.

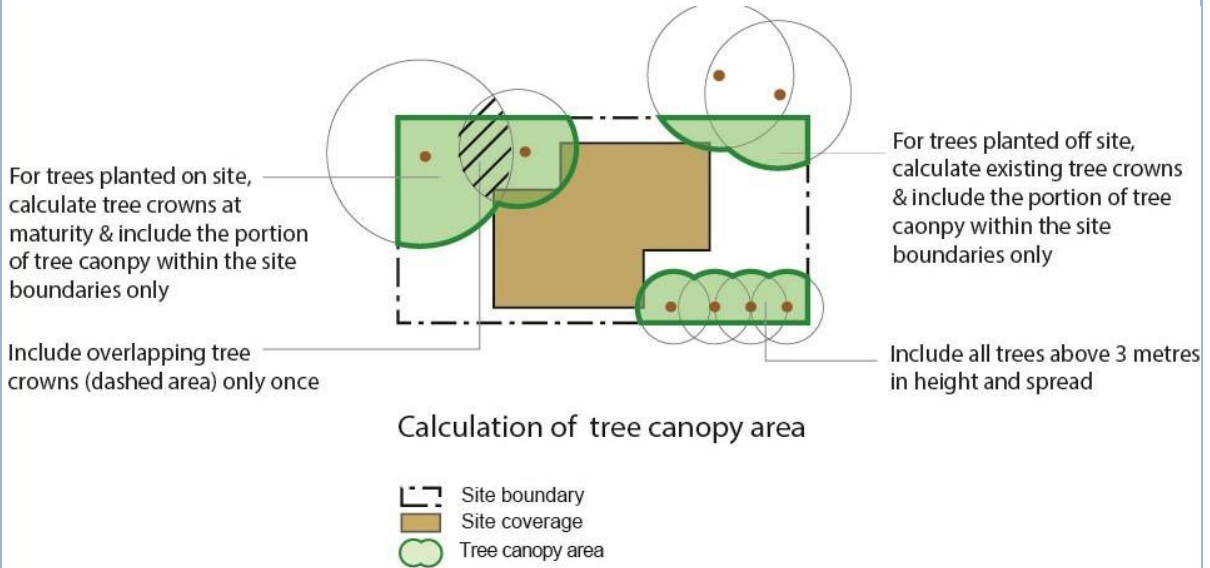
C3 At least 40% of the front setback comprises deep soil landscaped area.

**B3.7 External areas** ▶ 3.7.1 Landscaped area and private open space

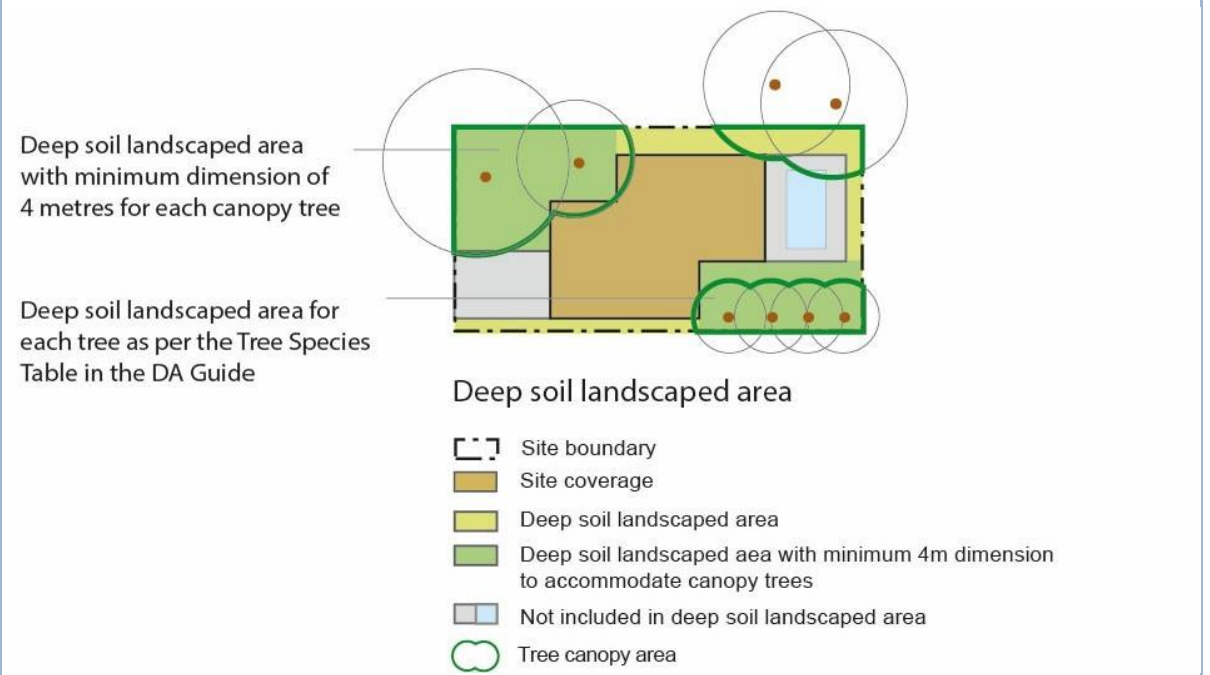
**Objectives**

**Controls**

**Figure 20**  
Calculation of tree canopy area



**Figure 21**  
Calculation of deep soil landscaped area



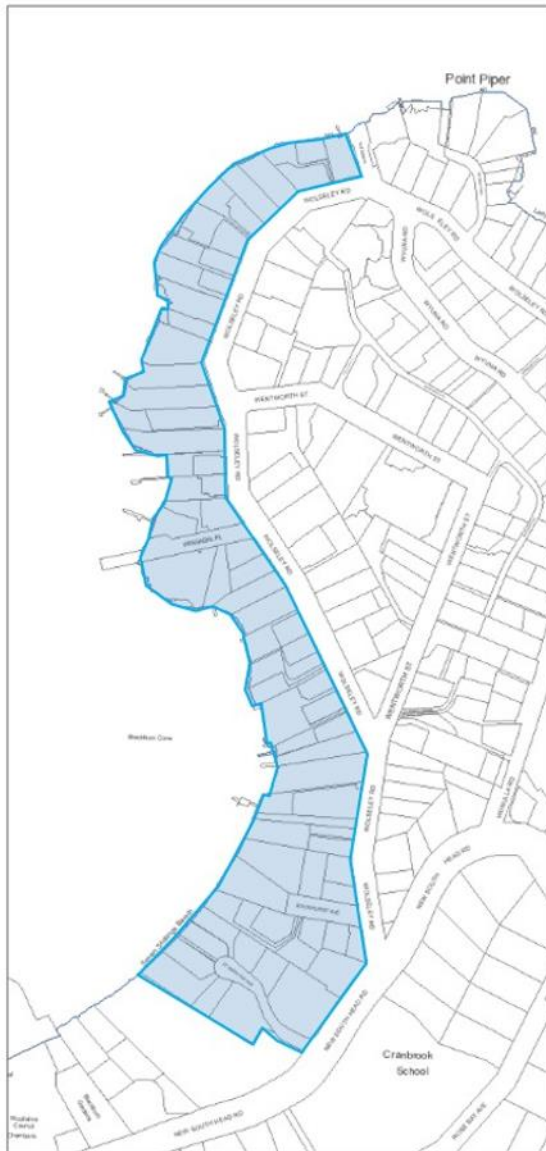
**B3.7 External areas** ▶ 3.7.1 Landscaped area and private open space

**Objectives**

**Controls**

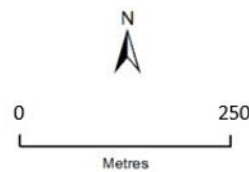
**Figure 22**

Sites subject to the 30% minimum deep soil landscaped area for dwelling houses, semi-detached dwellings and dual occupancies



**LEGEND**

 Wolseley Road Area



O4 To ensure the adequate provision of accessible and useable primary open space.

C4 For a dwelling house—a primary open space area of at least 35m<sup>2</sup> is provided.

C5 For each dwelling within a semi-detached dwelling, dual occupancy or attached dwelling—a primary open space area of at least 35m<sup>2</sup> is provided.



B3.7 External areas ► 3.7.1 Landscaped area and private open space	
Objectives	Controls
	<p>C6 The primary open space area in C4 and C5 above has a gradient of no more than 1 in 10 (refer to Figure 23).</p> <p>C7 Excavation or fill is permitted to achieve the required level area of primary open space up to 1.2m from existing ground level (refer to Figure 23).</p> <p>C8 Part of the primary open space area is directly accessible from a habitable room</p>
<p>O5 To ensure that dwellings in residential flat buildings, manor houses, multi dwelling housing or multi dwelling housing (terraces) are provided with adequate private open space that enhances the amenity of the dwellings.</p>	<p>C9 For residential flat building, manor houses, multi dwelling housing or multi dwelling housing (terraces) –each dwelling is provided with private open space which has a minimum area of 8m<sup>2</sup> and minimum dimensions of 2m x 2m. For dwellings above ground level, this may be in the form of a balcony, verandah or uncovered roof terrace and the like.</p>
<p>O6 To ensure that private open space areas are well-designed.</p>	<p>C10 Development takes advantage of opportunities to provide north facing private open space to achieve comfortable year round use.</p> <p>C11 Private open space is clearly defined for private use through planting, fencing or landscape features.</p> <p>C12 The location of private open space:                     <ul style="list-style-type: none"> <li>a) takes advantage of the outlook and natural features of the site;</li> <li>b) reduces the adverse privacy and overshadowing impacts; and</li> <li>c) addresses surveillance and privacy where private open space abuts public space.</li> </ul> </p> <p>C13 A roof terrace and associated structures will only be considered where the size, location and design of the terrace meets the requirements in Section 3.5.4 Acoustic and visual privacy.</p>

**B3.7 External areas ▶ 3.7.1 Landscaped area and private open space**

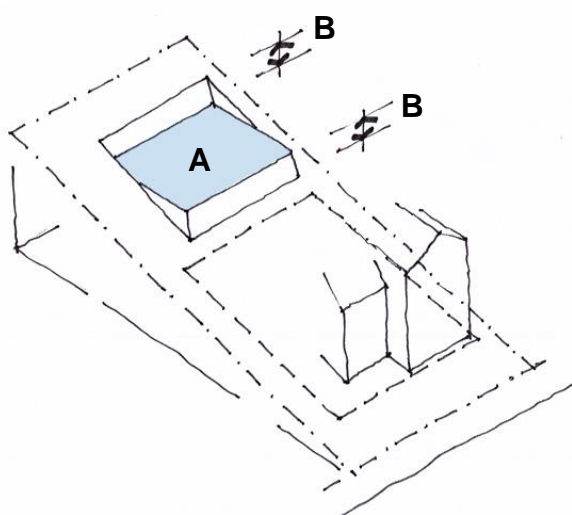
Objectives	Controls
O7 To retain important existing canopy trees, vegetation and other landscape features.	C14 Existing canopy trees and vegetation of landscape value are incorporated into the landscape area and treatment.
O8 To protect or enhance indigenous wildlife populations and habitat through appropriate planting of indigenous vegetation species.	C15 Native species are preferred, and landscape designs are encouraged to provide at least 50% of the plants as native species.
O9 To ensure that landscaping contributes positively to the streetscape and the amenity of neighbouring properties.	C16 Landscaping provides for a diversity of native species and a complexity of habitat through vertical layering. Note: Vertical layering, by planting a variety of vegetation in different sizes and heights provides more cover and feeding opportunities for wildlife species.
O10 To ensure that landscaping allows view sharing.	C17 Landscaping facilitates the linking of open space reserves through wildlife corridors and reduces habitat fragmentation and loss.
	C18 The landscape design: <ul style="list-style-type: none"> <li>a) uses vegetation types and landscaping styles which contribute to the streetscape and desired future character objectives for the locality;</li> <li>b) uses vegetation types that will not moderately, severely or devastatingly block views in accordance with the Tenacity Land and Environment Court Principle;</li> <li>c) does not adversely affect the structure of the proposed building or buildings on neighbouring properties;</li> <li>d) considers personal safety by ensuring good visibility along paths and driveways and avoiding shrubby landscaping near thoroughfares;</li> <li>e) contributes to energy efficiency and amenity by providing substantial shade in summer, especially to west facing windows and open car park areas and</li> </ul>

**B3.7 External areas** ▶ 3.7.1 Landscaped area and private open space

Objectives	Controls
	admitting winter sunlight to outdoor and living areas and other habitable rooms; f) improves privacy between dwellings; g) minimises risk of damage to overhead power lines and other services; and h) provides adequate sight lines for vehicles and pedestrians, especially near street corners and intersections.

Note: Deep soil landscaped area means: the area of the site that contains landscaped area which has no above ground, ground level or subterranean development.

Note: Canopy tree means: A tree that attains a minimum height of 8 metres and minimum crown diameter of 8 metres at maturity, and is planted in a deep soil landscaped area with a minimum dimension of 4 metres.



**FIGURE 23**  
 Provision of level area of primary open space  
**A** = Minimum area 35m<sup>2</sup>, maximum gradient 1:10  
**B** = Primary open space is to be no more than 1.2m above or below existing ground level

## B3.7.2 Fences

Fences and walls play major roles in determining the appearance of developments and their contribution towards the streetscape. Carefully designed fences and walls help to integrate developments into the existing streetscape. However, when poorly designed they can unduly dominate the streetscape and reduce opportunities for neighbourhood surveillance and social interaction.

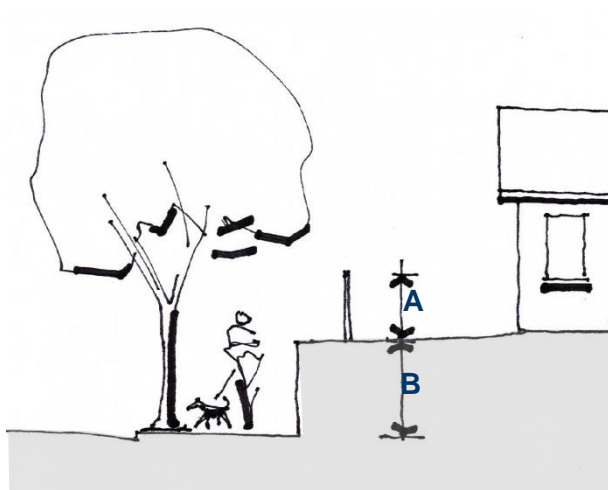
This DCP seeks to recognise both the importance of fences and walls to the privacy and security enjoyed by individual properties and the potential of fences and walls to contribute to creating or enhancing attractive streetscapes.

B3.7 External areas ▶ 3.7.2 Fences	
Objectives	Controls
O1 To ensure fences and walls improve amenity for existing and new residents and contribute positively to streetscape and adjacent buildings.	C1 Fencing is designed and located to protect the inhabitants of the property, and allows for casual surveillance from the building to the street.
O2 To ensure that fences and walls are not visually intrusive in the streetscape and to enhance pedestrian safety.	C2 The arrangement of built form, fences, landscaping and other features clearly defines any public, common, and private space.
O3 To ensure that fences and walls do not unreasonably restrict views and vistas from streets and other public spaces.	C3 Front fences and walls assist in defining building entrances.
O4 To ensure that development creates well defined areas of public and private space.	C4 The height of front fences does not exceed: <ul style="list-style-type: none"> <li>a) 1.2m if solid; or</li> <li>b) 1.5m if 50% transparent or open;</li> </ul> unless otherwise specified in the precinct controls in Chapters B1 and B2 of this part of the DCP. <p>Note: Chapters B1 and B2 define the desired future character for each precinct, and identify any special heritage, streetscape character and key elements within each precinct.</p>
	C5 Fences and gates on the low side of the street adjacent to each side boundary incorporate transparent or open panels to preserve district, iconic and harbour views from the street.

B3.7 External areas ▶ 3.7.2 Fences	
Objectives	Controls
	<p>C6 On the high side of streets where there is an increase in ground level in excess of 1.2m on the property side of the street alignment– the height of front fences and walls may increase to 1.2m from the level of the high side (refer to Figure 24).</p> <p>C7 Gates do not encroach over the street alignment when opening or closing.</p> <p>C8 Where a vehicular entrance is proposed in conjunction with a fence of height greater than 1.2m—a 45° splay or its equivalent is provided either side (as applicable) of the entrance to ensure driver and pedestrian vision. The splay is to have minimum dimensions of 2m x 2m (refer to Figure 25).</p>
<p>O5 To ensure boundary fences between sites provide visual privacy without affecting the amenity of those sites in terms of views and sunlight.</p>	<p>C9 The rear and side fences:</p> <ul style="list-style-type: none"> <li>a) are located behind the building front setback; and</li> <li>b) do not exceed 1.8m on level sites, or 1.8m as measured from the low side where there is a difference in level either side of the boundary.</li> </ul> <p>C10 Where there is a difference in ground level in excess of 1.2m either side of the boundary—the height of fences and walls may increase to 1.2m from the level of the high side (refer to Figure 26).</p>
<p>O6 To ensure fences and walls are sympathetic to the topography.</p>	<p>C11 For sloping streets—the height of fences and walls may be averaged and fences and walls may be regularly stepped.</p>

**B3.7 External areas** ▶ 3.7.2 Fences

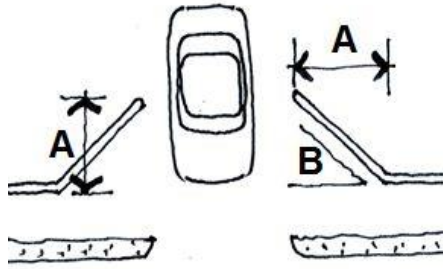
Objectives	Controls
O7 To protect and retain fences and walls that are important character elements for the precinct.	C12 Remnant sandstone and garden walls are retained and adequately maintained.
O8 To ensure materials used in fences and walls are a high quality and in keeping with the existing streetscape character and character of the building.	C13 Existing retaining walls that are important character elements in the street or precinct are retained.
	C14 Existing fences, particularly those constructed from sandstone, that are significant or represent important character elements in the street or precinct are retained.
	C15 The design and materials of front fences and walls are compatible with those fences and walls that contribute positively to the streetscape, (and the heritage context in the case of heritage conservation areas), and satisfy the desired future character and precinct controls in Chapters B1 and B2 of this DCP.
	C16 Fences and walls made from corrugated iron, barbed wire, and the like are not permitted.

**FIGURE 24**

Front fences on the high side of streets

**A** = 1.2m maximum

**B** = Increase in ground level greater than 1.2m

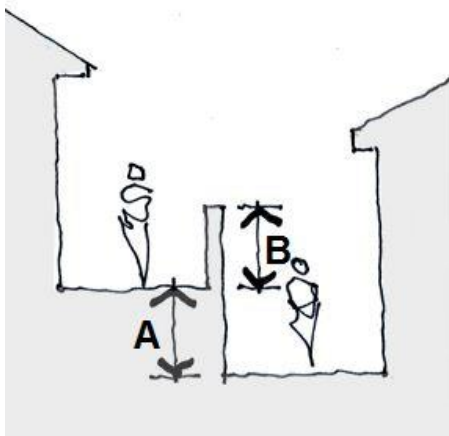


**FIGURE 25**

Splays for driveway entrances where fence height exceeds 1.2m

**A** = 2m minimum

**B** = 45° splay



**FIGURE 26**

Side and rear boundary fences where levels change between properties

**A** = Increase in ground level greater than 1.2m

**B** = 1.2 maximum

### B3.7.3 Site facilities

Site facilities include those facilities or services that support and, or, maintain the operations of a building. All forms of development include site facilities. These include, but are not limited to:

- On-site services including storage, garbage areas, mail boxes, clothes drying areas, vent stacks, and telecommunications infrastructure
- Mechanical plant rooms and equipment and other building services such as pump rooms, lift overruns, air-conditioning units and condensers, heating, mechanical ventilation systems, ventilation duct outlets, including any pipes and conduits
- Essential services and infrastructure such as electricity substations, fire hydrant and booster installations.

Some site facilities can be visually intrusive and have an adverse impact on the amenity of the streetscape and adjoining neighbours. It is important that the location, size and design of site facilities is considered and planned for during the design phase of any proposed development so the facilities can be thoughtfully integrated into the built form and landscaping, and potential impacts addressed.

Development applications are to be accompanied by dimensioned plans, drawn to scale, showing proposed locations and arrangements for site facilities including, where applicable:

- mechanical plant rooms and lift-overruns
- enclosures and/or cabinets for fire hydrants, booster valve assembly installations, sprinkler valves and associated hydraulic equipment
- an electricity substation.

The need to modify an existing consent to provide for a site facility should be avoided, and is an approach not supported by Council. Section 4.55 modification applications will need to demonstrate compliance with the DCP including requirements for setbacks, deep soil landscaped area, and tree retention etc. Council will not permit site facilities on public land.

B3.7 External areas ▶ 3.7.3 Site facilities			
Objectives		Controls	
O1	To ensure that mail boxes are suitably located and designed.	C1	Lockable mail boxes are provided close to the street and are integrated with front fences or building entries.
O2	To provide adequate storage facilities in residential development.	C2	Lockable storage space of at least 8m <sup>3</sup> per dwelling is provided.
O3	To encourage the use of natural resources to dry clothes.	C3	Development that includes a residential component provides opportunity for at least one external clothes drying area.
O4	To ensure external clothes drying areas are suitably located.	C4	External clothes drying areas have access to sunlight, and are located in a secure



B3.7 External areas ▶ 3.7.3 Site facilities	
Objectives	Controls
	<p>place away from public spaces and screened from public view.</p> <p>Note: External drying areas may be located in the deep soil landscaped area.</p>
<p>O5 To ensure that aerials, antennae, and communications dishes must be thoughtfully integrated into development and are unobtrusive.</p>	<p>C5 Developments involving three or more dwellings share one common television antennae or satellite dish.</p> <p>C6 The design and location of aerials, antennae, and communications dishes:</p> <ul style="list-style-type: none"> <li>a) do not have an unreasonable impact on the architectural character of the building to which it is attached;</li> <li>b) are not visually intrusive within the streetscape; and</li> <li>c) do not have an unreasonable impact on the amenity of adjoining and adjacent properties.</li> </ul>

B3.7 External areas ▶ 3.7.3 Site facilities	
Objectives	Controls
O6 To ensure that mechanical plant equipment including lift overruns, air-conditioning units and external condensers, do not have adverse streetscape or amenity impacts.	C7 Mechanical plant equipment (including lift overruns and air conditioners) must be located internally within the principal building in a suitably designed plant room or the like.
O7 To discourage the provision of mechanical plant equipment on the roofs of buildings to minimise clutter and visual impacts created by intrusive site facilities.	C8 Mechanical plant equipment (including lift overruns and air conditioners) must be wholly contained within the permissible building envelope and must not be located externally or on the roof unless Council is satisfied that it:
O8 To minimise visual and acoustic impacts on adjoining properties	<ul style="list-style-type: none"> <li>a) cannot be reasonably located elsewhere; and</li> <li>b) is thoughtfully located, sized, enclosed, concealed and integrated into the building design (including when viewed from above) and roof form so it: <ul style="list-style-type: none"> <li>i. is not visible from the streetscape or public domain;</li> <li>ii. is consistent with the overall building design, roof form and materials;</li> <li>iii. is visually discreet and unobtrusive when viewed from adjoining properties; and</li> <li>iv. minimises acoustic impacts to adjoining properties.</li> </ul> </li> </ul> <p>Note: Noise emissions from mechanical plant equipment must not exceed the background noise levels when measured at the boundary of the development site. The provisions of the <i>Protection of the Environment Operations Act 1997</i> apply.</p>

B3.7 External areas ▶ 3.7.3 Site facilities	
Objectives	Controls
	<p>C9 Screening will only be considered where the screening is suitably located, integrated with the building design and materials and will have no impact on views or result in overshadowing of adjoining properties.</p> <p>Note: Screening alone may not be an acceptable solution for ensuring that mechanical plant equipment is not visible from the streetscape or the public domain.</p>
O9 To protect the air quality and residential amenity.	C10 New fireplaces burn non-solid fuels, e.g. gas or electricity.
O10 To ensure that development incorporates adequate garbage and recycling collection areas.	C11 Refer to Part E of the DCP, Chapter E5 Waste Management.
O11 To ensure that site services are accessible, functional and do not have a negative impact on the streetscape.	<p>C12 Site services are suitably integrated with the development including the landscape design and are not visually intrusive within the streetscape.</p> <p>C13 Hydraulic fire services such as fire hydrants and booster installations are concealed. These services are to be:</p> <ul style="list-style-type: none"> <li>a) enclosed with doors if located in the building façade, or</li> <li>b) housed in a cabinet or enclosure if located external to the building.</li> </ul> <p>The location, design, colour and material of the doors, cabinet or enclosure are visually unobtrusive and suitably integrated with the development, including fencing and landscaping.</p>

B3.7 External areas ▶ 3.7.3 Site facilities	
Objectives	Controls
O12 To ensure that an electricity substation is not visible from the street, or any other adjoining public place.	C14 The substation is to be suitably located, screened and/or concealed. Council's preference is for a chamber substation.
O13 To ensure that any screening or enclosure to conceal the substation does not detract from the streetscape character or design quality of the development.	C15 Any screening or enclosure to conceal the substation is to be visually unobtrusive and suitably integrated with the development, including the fencing and landscape design.
O14 To protect the amenity of adjoining residential dwellings from substations.	C16 The substation is to be located away from neighbouring properties or sufficiently screened from neighbouring properties.
O15 To ensure that vegetation does not interfere with the functioning of the substation.	C17 The location and design of the electricity substation must be considered and integrated with the landscaping of the proposed development, and must ensure that: <ul style="list-style-type: none"> <li>a) Vegetation does not overhang or encroach within the substation site.</li> <li>b) The substation is installed outside of the mature growth root zone of any trees to be retained, or proposed to be planted, to prevent roots damage to underground cables.</li> </ul>
O16 To minimise the impact of other types of electricity infrastructure in the streetscape.	C18 The design and location of all other aboveground utility infrastructure (such as electrical pillars etc.) should minimise visual clutter within the streetscape and provide for a continuous accessible path of travel, where practical to ensure safe and equitable pedestrian circulation for people of all abilities. (Where this provision and Ausgrid's requirements cannot both be satisfied, the applicant is to develop in consultation with Council and Ausgrid a solution that meets the acceptance of both consent authorities.)

**B3.7 External areas** ▶ *3.7.3 Site facilities*

**Objectives**

**Controls**

Notes:

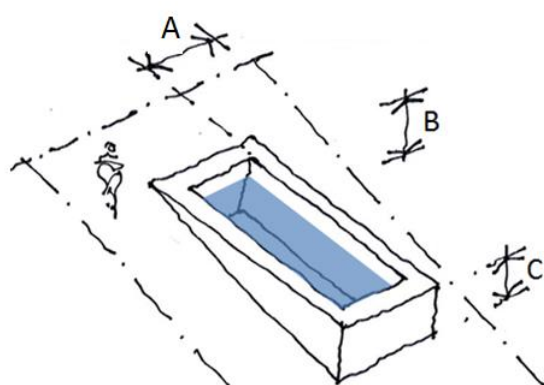
- At the DA stage the applicant should demonstrate that they have engaged with Ausgrid and have a network capacity assessment undertaken for the proposed development.
- Where a substation is required, the substation should be identified on the DA plans and addressed in the *SEPP 65 Design Verification Statement* (also see Apartment Design Guide Objective 3C-2 Amenity of the public domain is retained and enhanced).
- The DCP requirements apply in addition to the Ausgrid Network Standards, such as *NS113 Site selection and construction design requirements for chamber substations*. Separate Ausgrid approval for the substation will be required.
- A dedicated access way/easement through the site to the substation will also need to be provided in accordance with the requirements of Ausgrid and Council.

## B3.7.4 Ancillary development – swimming pools, tennis, basketball and sports courts and outbuildings

### Swimming pools

A swimming pool is an impermeable structure capable of holding water to a depth greater than 300mm for swimming or other recreation purposes, but does not include a spa pool.

B3.7 External areas ▶ 3.7.4 Ancillary development - swimming pools	
Objectives	Controls
O1 To provide for recreational opportunities for swimming without compromising the amenity of the neighbouring properties.	C1 The swimming pool does not occupy the deep soil landscaped area.
O2 To limit excavation.	C2 Excavation beyond the controls in Section B3.4 is permitted to accommodate a backyard swimming pool, where the pool is outside the building envelope.  Note: This concession does not apply to a swimming pool in a basement area.
O3 To retain trees and vegetation of landscape value.	C3 The swimming pool (measured from the water edge) is at least 1.8m from property boundaries.  C4 The swimming pool surrounds are no more than 1.2m above or below the existing ground level.  C5 The swimming pool is no deeper than 2m from the pool surround level (refer to Figure 27).  C6 The location and design of the swimming pool and associated works do not adversely impact on prescribed trees (refer to Chapter E3 Tree Management).



**FIGURE 27**  
 Provision of private swimming pools  
**A** is a minimum of 1.8m  
**B** = pool depth is a maximum of 2m  
**C** is to be a maximum of 1.2m

### Tennis, basketball and sports courts

Tennis courts, basketball courts and other sports courts typically comprise of a hard court surface and other associated structures such as a net, hoop, and lighting. When constructed or installed in the private open space of a residential dwelling, the court is often a modified size and fenced to contain balls on the court during play.

Private outdoor recreation and exercise contributes to a healthy lifestyle and the enjoyment of residents. However, noise generated from people playing on sports courts in a residential area can sometimes impact on the acoustic privacy of adjoining neighbours. The associated fencing and outdoor lighting can also have detrimental amenity impacts.

When a tennis court, basketball court, or other sports court is proposed, it is important that the size, location and design of the court considers potential amenity impacts, and the excavation, tree and deep soil landscaping objectives are met.

#### B3.7 External areas ▶ 3.7.4 Ancillary development - tennis, basketball and sports courts

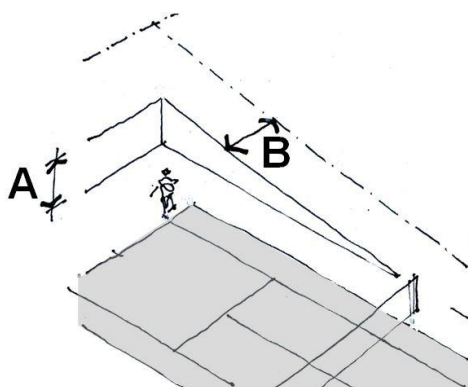
Objectives		Controls	
O1	To provide recreational opportunities for playing tennis, basketball or other sports without compromising the amenity of adjoining and adjacent properties, or the desired future character or streetscape.	C1	The court level is a maximum of 1.2m above or below the existing ground level (refer to Figure 28).
		C2	The court is: a) located at the rear of the site; and b) at least 1.5m from property boundaries (refer to example at Figure 28).
O2	To limit excavation.		
O3	To retain trees and vegetation of landscape value, deep soil landscaped area, and private open space areas.		
O4	To ensure that adequate provision has been made for the disposal of stormwater.	C3	The court playing surface is made from a material that minimises light reflection.
		C4	The height, location and materials of court fencing, netting or other forms of

ball containment does not unreasonably compromise:

- a) sharing of views from surrounding properties; or
- b) solar access to neighbouring properties; or
- c) outlook from surrounding properties.

- C5 Fencing, netting or other forms of ball containment must comprise of a material which is a recessive colour.
- C6 Where court lighting is proposed, the lighting must not unreasonably impact on the amenity of adjoining or adjacent properties. The lighting must be designed to comply with AS/NZS 4282: Control of the obtrusive effects of outdoor lighting. No private tennis, basketball, or sports court lighting must operate between 9.00pm and 7.00am and lights must, by automatic timer, switch off at the 9.00pm curfew.
- C7 The location of the court and associated works does not adversely impact on prescribed trees (refer to Chapter E3 Tree Management).
- C8 The court must not reduce the deep soil landscaped area, and the private open space areas below the minimum required for development, as specified in Section 3.7.1 Landscaped areas and private open space.
- C9 Surface water or runoff is disposed of by a drainage system that is connected to the main stormwater drainage system (refer to Chapter E2 Stormwater and Flood Risk Management).





**FIGURE 28**  
Provision of private tennis, basketball and sports courts on residential sites

**A** is to be a maximum of 1.2m

**B** is to be a minimum of 1.5m

### Outbuildings

Although development outside the building envelope is generally not permitted, small outbuildings such as a cabana, cubby house, fernery, garden shed, gazebo, greenhouse or the like, may be located within the rear the setback.

B3.7 External areas ▶ 3.7.4 Ancillary development - outbuildings	
Objectives	Controls
<p>O1 To ensure that outbuildings do not unreasonably compromise the amenity of the occupants or the neighbouring properties.</p>	<p>C1 The outbuilding is located within the building envelope or the rear setback.</p> <p>C2 Maximum height of the outbuilding is 3.6m and the outbuilding is to be sited a minimum of 1.5m from the side and rear boundaries.</p>
<p>O2 To ensure that the required deep soil landscaped area and level area of private open space are achieved.</p>	<p>C3 The outbuilding, if located outside the building envelope, does not reduce the deep soil landscaped area and the private open space areas below the minimum required for development, as specified in Section 3.7.1 Landscaped areas and private open space.</p>
<p>Notes:</p> <ul style="list-style-type: none"> <li>Outbuilding means any of the following: cabana, cubby house, fernery, garden shed, gazebo or greenhouse, carport that is detached from a dwelling house, garage that is detached from a dwelling house,</li> </ul>	

---

rainwater tank (above ground) that is detached from a dwelling house, shade structure that is detached from a dwelling house, shed.

- Controls for outbuildings which comprise parking structures are contained in Section B3.6.

## B3.8 Additional controls for development other than dwelling houses

This section includes additional controls for the following types of development:

- ▶ secondary dwellings;
- ▶ semi-detached dwellings;
- ▶ dual occupancies;
- ▶ attached dwellings;
- ▶ residential flat buildings;
- ▶ manor houses;
- ▶ multi-dwelling housing;
- ▶ multi dwelling housing (terraces);
- ▶ Inter-War flat buildings; and
- ▶ post-1950s residential towers.

These controls apply in addition to the controls in Sections B3.2-B3.7.

### B3.8.1 Minimum lot width

The minimum lot width, as measured from the street frontage, is the minimum required to accommodate development on a site.

The controls below apply to detached dual occupancies, attached dwellings, residential flat buildings, manor houses, multi dwelling housing and multi dwelling housing (terraces) recognising that these forms of development require a minimum width to ensure that each dwelling in the development can be designed to provide reasonable amenity having regard to issues such as privacy, building separation, open space and to achieve planned residential density in certain zones consistent with the desired future character of the neighbourhood.

**B3.8 Additional controls** ▶ 3.8.1 *Minimum lot width*

Objectives	Controls
<p>O1 To ensure that sites have a minimum width to provide sufficient space between buildings to allow satisfactory amenity for occupants and neighbouring properties and for effective landscaping and pedestrian access.</p>	<p>C1 The parent lot has a minimum width at the street front alignment as follows:</p> <ul style="list-style-type: none"> <li>c) detached dual occupancy—21m;</li> <li>d) attached dwellings—24m;</li> <li>e) residential flat building, manor houses, multi dwelling housing or multi dwelling housing (terraces) containing three dwellings—15m; and</li> <li>f) residential flat building, multi dwelling housing, multi dwelling housing or multi dwelling housing (terraces) or containing four or more dwellings—21m.</li> </ul>
<p>O2 To ensure that lot widths facilitate a built form with a bulk and scale that is consistent with the desired future character of the area.</p>	<p>Notes:</p> <ul style="list-style-type: none"> <li>• No minimum lot width applies to a dwelling house, semi-detached dwelling or attached dual occupancy.</li> <li>• The parent lot refers to the development site before any subdivision (if relevant).</li> <li>• These controls do not apply to battle-axe lots (refer to Section B3.9).</li> </ul>
<p>O3 To ensure there is adequate width for efficient on-site car parking.</p>	
<p>O4 To ensure that excavation can be adequately set back from boundaries and to prevent excessive excavation.</p>	
<p>O5 To encourage consolidation of allotments in appropriate locations to enable the development of a diversity of dwelling types.</p>	

## B3.8.2 Secondary dwellings

Under Woollahra LEP 2014, secondary dwelling means a self-contained dwelling that:

- a) is established in conjunction with another dwelling (the principal dwelling);
- b) is on the same lot of land as the principal dwelling; and
- c) is located within, or is attached to, or is separate from, the principal dwelling.

Clause 5.4 of Woollahra LEP 2014 sets the maximum size of a secondary dwelling, being 60m<sup>2</sup>, or not more than 5% of the total floor area of the principal dwelling.

### B3.8 Additional controls for development other than dwelling houses

#### ▶ 3.8.2 Secondary dwellings

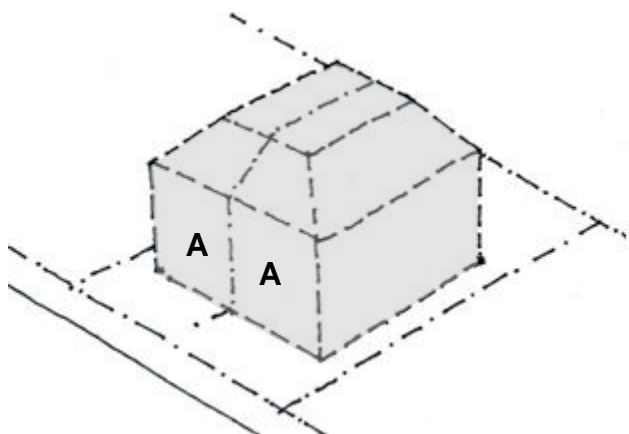
Objectives	Controls
<p>O1 To ensure that amenity is provided to the occupants of the principal dwelling, secondary dwelling and to neighbouring properties.</p>	<p>C1 The secondary dwelling is located within the building envelope.</p> <p>Note: Only a secondary dwelling approved under the <i>State Environmental Planning Policy (Housing) 2021</i> may be located outside the building envelope.</p> <p>C2 Both the principal and secondary dwellings have direct access to private open space.</p>

### B3.8.3 Semi-detached dwellings

Under Woollahra LEP 2014, a semi-detached dwelling means a dwelling that is on its own lot of land and is attached to only one other dwelling (refer to Figure 29).

This section includes controls relating to:

- ▶ new semi-detached dwelling development; and
- ▶ alterations and additions to existing semi-detached dwellings.



**FIGURE 29**  
Semi-detached dwellings  
**A = Semi-detached dwellings**

B3.8 Additional controls for development other than dwelling houses	
▶ 3.8.3 Semi-detached dwellings	
Objectives	Controls
<b>For new development</b>	
O1 To encourage semi-detached dwellings to present as a uniform built form.	C1 Both dwellings in the development have an integrated design and are complementary to each other in terms of style, design, materials, roof form and colour scheme.

**B3.8 Additional controls for development other than dwelling houses**

**3.8.3 Semi-detached dwellings**

**Objectives**

**Controls**

**For alterations and additions to existing semi-detached development**

<p>O2 To ensure that a proposal to redevelop one semi-detached dwelling in a pair does not adversely affect the development potential of the unaltered dwelling.</p>	<p>C2 Alterations and additions to one semi-detached dwelling in a pair do not unreasonably prevent the redevelopment of the remaining semi-detached dwelling at a later date.</p> <p>C3 Windows facing the common elevation between each semi-detached dwelling are avoided.</p>
<p>O3 To ensure that the original streetscape contribution and character of semi-detached dwellings is retained and enhanced.</p>	<p>C4 First floor additions are set back beyond the apex or main ridge of the existing principal roof form.</p> <p>C5 Existing chimneys are retained.</p> <p>C6 Dormers are not located in the street elevation of the building.</p> <p>C7 The key architectural elements of the original building are retained.</p>
<p>O4 To ensure that additions and alterations to one semi-detached dwelling respects the scale, detailing and characteristics of the pair.</p>	<p>C8 Alterations and additions to one of a pair of semi-detached dwellings does not dominate or compromise the uniformity or geometry of the principal or street front elevation.</p> <p>Where symmetry is the dominant characteristic it should be respected; where asymmetry gives the appearance of a single building this should be respectfully acknowledged in the design to maintain that character.</p> <p>C9 The style, pitch, material, profile and colour of the proposed roof form matches, complements and extends the existing roof form of the building. Uncharacteristic roof forms and details that detract from the character of the adjoining semi-detached dwelling are avoided.</p>

**B3.8 Additional controls for development other than dwelling houses****▶ 3.8.3 Semi-detached dwellings**

Objectives	Controls
	<p data-bbox="802 389 1382 495">C10 Roof design does not adversely impact on the adjoining semi-detached dwelling or create stormwater spillover.</p> <p data-bbox="802 524 1390 663">C11 External colour schemes and materials are sympathetic to the character of the original building and the other semi-detached dwelling.</p>



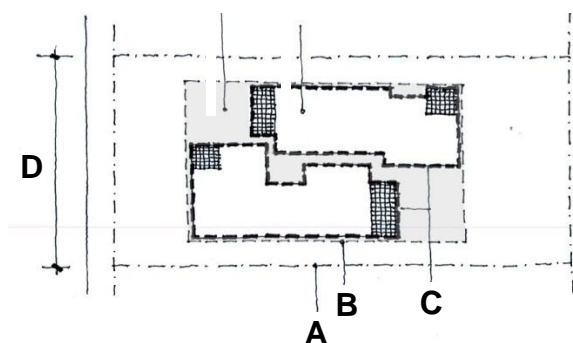
### B3.8.4 Dual occupancy

A dual occupancy means two dwellings on one lot of land (refer to Figure 30).

Under Woollahra LEP 2014, dual occupancies are defined as:

- ▶ **dual occupancy (attached)** means two dwellings on one lot of land that are attached to each other, but does not include a secondary dwelling.
- ▶ **dual occupancy (detached)** means two detached dwellings on one lot of land, but does not include a secondary dwelling.

Clause 4.1A of Woollahra LEP 2014 sets the minimum lot size of dual occupancies.



**FIGURE 30**  
Example layout of detached dual occupancy within the building envelope

**A** = Lot boundary

**B** = Building envelope

**C** = Extent of building

**D** = 21m minimum frontage

#### B3.8 Additional controls for development other than dwelling houses

##### ▶ 3.8.4 Dual occupancy

Objectives	Controls
O1 To ensure that the development presents as an integrated design.	C1 Both dwellings in the development complement each other in terms of style, design, materials, roof form and colour scheme.
O2 To ensure useable and well located areas of private open space.	C2 Private open space areas are not located within the front setback area.
	C3 Each dwelling has direct access to its own private open space area.
	C4 Private open space areas are not overlooked by the other dual occupancy dwelling in the development.

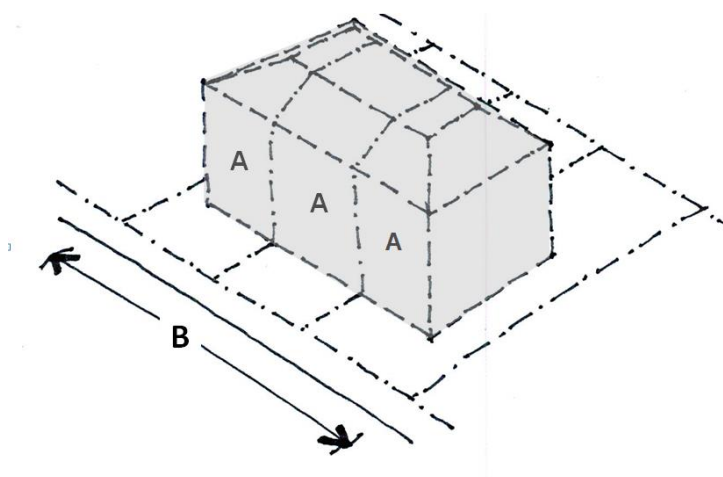
<p>O3 To ensure that on-site parking does not detract from the streetscape character and amenity.</p> <p>O4 To minimise loss of on-street parking.</p>	<p>C5 Both dual occupancies share a common driveway cross-over. Separate cross overs may be considered on corner lots, where the access is from separate streets.</p>
--	---

### B3.8.5 Attached dwellings

Under Woollahra LEP 2014, attached dwelling means a building containing three or more dwellings, where:

- a) each dwelling is attached to another dwelling by a common wall;
- b) each of the dwellings is on its own lot of land; and
- c) none of the dwellings are located above any part of another dwelling.

Refer to Figure 31.



**FIGURE 31**  
Attached dwellings  
**A** = Attached dwellings  
**B** = 24m minimum frontage

B3.8 Additional controls for development other than dwelling houses			
▶ 3.8.5 Attached dwellings			
Objectives		Controls	
O1	To ensure that the development presents as an integrated design.	C1	All dwellings in the development complement each other in terms of style, design, materials, roof form and colour scheme.
O2	To ensure that on-site parking does not detract from the streetscape character and amenity.	C2	If basement parking is not provided, at grade parking is located at the rear.

Parking structures addressing the street are not encouraged.

### B3.8.6 Residential flat buildings, manor houses, multi dwelling housing and multi dwelling housing (terraces)

Woollahra LEP 2014 defines the following types of residential accommodation:

- ▶ **residential flat building** means a building containing three or more dwellings, but does not include an attached dwelling or multi dwelling housing.
- ▶ **manor houses** as defined in *State Environmental Planning Policy (Exempt and Complying Development Codes) 2008*.
- ▶ **multi dwelling housing** means three or more dwellings (whether attached or detached) on one lot of land, each with access at ground level, but does not include a residential flat building.
- ▶ **multi dwelling housing (terraces)** as defined in Woollahra LEP 2014.

In addition to the DCP controls, the NSW Government’s *State Environmental Planning Policy No. 65 - Design Quality of Residential Apartment Development (SEPP 65)* is also a mandatory consideration for all applications for residential flat buildings and multi dwelling housing that is three or more storeys and contains four or more self-contained dwellings.

SEPP 65 contains principles for good design and provides guidance for evaluating the merit of design solutions, and is supported by the Apartment Design Guide. The guide contains detailed information about how development proposals can achieve the design quality principles in the SEPP, addressing matters such as building separation and building configuration.

Where SEPP 65 applies, the development application must be accompanied by a design verification from a qualified designer, confirming that:

- ▶ he or she designed, or directed the design, of the development; and
- ▶ the design quality principles set out in SEPP 65 are achieved for the development.

#### B3.8 Additional controls for development other than dwelling houses

##### ▶ 3.8.6 Residential flat buildings, manor houses, multi dwelling housing and multi dwelling housing (terraces)

Objectives	Controls
O1 To ensure that dwellings within the development provide good amenity.	C1 Internal layout and window placement achieves good natural ventilation.  C2 Single aspect dwellings are limited in depth to 8m from a window.

**B3.8 Additional controls for development other than dwelling houses****▶ 3.8.6 Residential flat buildings, manor houses, multi dwelling housing and multi dwelling housing (terraces)**

Objectives	Controls
	<p>C3 The back of the kitchen is no more than 8m from a window.</p> <p>C4 The width of a cross-over or cross-through dwelling over 15m deep is 4m or greater. Deep and narrow dwelling layouts are avoided.</p> <p>C5 Where practical, habitable rooms excluding bedrooms are oriented to the north for maximum solar access.</p> <p>C6 Light wells as the main source of lighting and ventilation to dwellings is avoided.</p>
<p>O2 To ensure useable and well located areas of private open space that provide good amenity for residents.</p>	<p>C7 Each dwelling has direct access to its own private open space area.</p> <p>C8 Private open space areas are located and designed to minimise overlooking from other dwellings in the development.</p> <p>Note: For requirements for adaptable housing in residential flat buildings, manor houses, multi dwelling housing, multi dwelling housing (terraces) and mixed use developments refer to Part E8 of the DCP.</p>

---

### B3.8.7 Inter-War flat buildings

---

Inter-War flat buildings were constructed in many parts of the Woollahra LGA. Many of these buildings make an important historic, aesthetic, social and technical contribution to the character of areas and to the historical development of the area.

Inter-War flat buildings are defined as two storeys or more and containing two or more dwellings, constructed in the period circa 1918 to circa 1950.

This definition includes years outside the recognised 'Inter-War period' of 1918 to 1939. This is to recognise a building type and not exclusively buildings constructed between certain years.

This building type is distinguishable by common characteristics and styles. There are many examples of residential flat buildings with these characteristics that were constructed after 1939.

There are numerous cohesive groups and one-off examples that demonstrate the key characteristics of architectural styles of the Inter-War period including Art Deco, Mediterranean, Georgian Revival, Spanish Mission, Skyscraper Gothic and Functionalist. Many of the Inter-War flat buildings across the LGA were designed by prominent architects such as Leslie Wilkinson, Emil Sodersten, Aaron Bolot, Eric Clarke Pitt, John R. Brogan and Samuel Lipson.

Externally, many buildings and their settings are substantially intact. Modern day renovation trends that include rendering or bagging face brick, altering window patterns and enclosing balconies have detrimental impacts on the character of these buildings, particularly their aesthetic values, and also on the general streetscape.

#### Streetscape

The streetscape is the connection between the private and public domain. The character of the Inter-War flat building streetscapes is their consistency in architectural style, scale, form, front and side setbacks, finishes and materials. In streets characterised by Inter-War residential building development, the subdivision pattern and regular separation of buildings often provides public views to surrounding areas and landmarks.

#### Landscaped area

The landscaped garden setting is an important element of Inter-War flat buildings and contributes to the character of the building and its setting. The garden setting usually comprises perimeter planting in narrow strips along the front of the buildings and along the side boundary fences framing a small lawn area in front of the buildings.

#### Building form

The predominant plan form of principal buildings is of a stepped nature with bays, indents, verandahs, balconies and other elements to break up the mass of the building and in particular the street front elevation.

Highly characteristic detailing defines each style within the Inter-War period and contributes to the building's character. Each style can be characterised by the following elements:

- ▶ Art Deco: Face brickwork, vertical and horizontal brick fins, decorative stepped parapets, symmetry, three dimensional massing, geometric curves.

- 
- ▶ Mediterranean: Rendered and lime washed walls, round or Marseille tiles, accents of classical detail such as round arches, timber shutter, ornate fine ironwork railings.
  - ▶ Georgian Revival: Symmetry, fine face brickwork, 12 pane windows, repetitive fenestration, semi-circular headed windows, classical columns and pediments.
  - ▶ Spanish Mission: Plain rendered or textured stucco with concentrations of ornament, gabled roofs with curved parapets, half-round terra cotta tiles, triple arch windows, ‘barley-sugar’ columns.
  - ▶ Skyscraper Gothic: Medieval motifs, tall tower elements, vertical fins, stepped parapets.
  - ▶ Functionalist: Asymmetrical massing of simple geometric shapes, steel-framed windows, contrasting horizontal and vertical motifs, large areas of glass.

### Building height

The height of Inter-War flat buildings is generally consistent within the streetscape. The buildings are usually 2 or 3 storeys, but may be up to 10 or 12 storeys.

### Materials

Materials characteristic of Inter-War flat buildings are:

- ▶ walls—brick, render/stucco;
- ▶ windows—timber double hung or casement; and
- ▶ roofs—glazed terracotta tile.

### Alterations, additions and repairs

Alterations and additions to Inter-War flat buildings should have regard to the existing character of the building and its setting.

Where external elevations and internal common areas are intact, applicants are encouraged to confine alterations to internal areas of individual apartments.

Services and fire upgrades must be carefully planned and detailed. To avoid damage to characteristic internal and external details, repairs to building elements are to retain existing detailing and be equal to the original quality and design of material finishes, fixtures and fittings.

### Roofscapes and chimneys

The roof is an important characteristic of Inter-War flat buildings and is generally a hipped or gabled form with a tiled roof structure and decorative parapet features. It contributes strongly to the overall form, proportions and character of the building.

Chimneys are an important characteristic of pre-1950 residential flat buildings and add to the character of the overall building form and area. For example, chimneys may relate to a centralised incinerator system, reflecting a previous technology that is of historic interest.

Dormer windows to the existing roof forms are inappropriate and out of character with Inter-War flat buildings and are intrusive in the roof form. Skylights are intrusive in roof forms and are restricted to areas that are not visibly prominent.

---

### Fences, gates and mailboxes

The front fences of Inter-War flat buildings are usually low scale and constructed of masonry, often incorporating or repeating details used in the building. Gates are generally wrought iron with fine craftsmanship in a design appropriate to the character of the building, and also match external balcony balustrades.

Mailboxes are often timber in a masonry enclosure and located at or near the front fence, or within or near the main entrance to the building.

### Ancillary structures

Ancillary structures for Inter-War flat buildings are those buildings that are not the principal building and include, but are not limited to: carports, garages, garbage areas and laundries.

### External materials, details and finishes

External materials, details and finishes and the way they in which these are used are important elements that contribute to the overall character of a building. Face brickwork is a key characteristic of Inter-War flat buildings. The use of masonry patterns including two-tone brickwork, squints (corner bricks), textured bricks and herringbone brickwork can contribute to aesthetic value to an Inter-War flat building.

### Verandahs and balconies

Existing verandahs and balconies are an important characteristic of Inter-War flat buildings, in addition to being functional and adding visual interest to the exterior by creating shadows. The addition of new balconies can have a highly negative visual impact on the character of the building. Where external elevations are intact and the building displays distinctive characteristic detailing, verandah additions should be limited to building elevations that are not highly visible from the street.

### Security devices

In some cases the original door and window hardware does not provide the necessary level of security for contemporary requirements. Additional security devices can be provided sympathetically whilst retaining original hardware and the character of the building.

### Fire protection upgrading

To comply with BCA and other requirements, it is sometimes necessary to upgrade the building with additional fire protection equipment or measures. Where characteristic internal and external detailing exists, fire protection upgrading should be sympathetically incorporated to minimise adverse impacts to original fabric and characteristic features of the building, such as doors and fireplaces.

### Objectives and controls for alterations and additions to Inter-War flat buildings

Note: The controls below apply in addition to the general residential controls in this chapter. Where there is an inconsistency, the controls below take precedence.

B3.8 Additional controls for development other than dwelling houses	
▶ 3.8.7 Inter-War flat buildings	
Objectives	Controls
<b>Streetscape</b>	
O1 To ensure that the significant characteristics of Inter-War flat buildings that contribute to the character of the area, are retained and protected.	C1 For Inter-War flat buildings that are heritage items or located in a HCA—No alterations or additions to the significant and/or original forms, details, fabrics, materials or finishes of the principal building elevations, except for restoration or reconstruction.
O2 To conserve the principal street elevations of the Inter-War flat buildings that contribute to the character of the area.	C2 For Inter-War flat buildings that contribute to the character of the area, are not heritage items or located in a HCA—Alterations or additions to the significant forms, details, materials or finishes of the principal building elevations are sympathetic to the style and period of the building, and do not dominate the building.
O3 To ensure that the architectural character of Inter-War flat buildings that contribute to the character of the area is not compromised.	C3 The articulated, stepped and faceted plan form of the building is not altered or obscured, particularly at the street elevation.
O4 To ensure that the character of original roofscapes, including key elements such as chimneys, is maintained.	C4 Alterations and additions are no higher than the existing roof level, and generally retain the original roof form of the building.
O5 To ensure that alterations and additions to the roofs are discreet and do not detract from the original character, proportions or key elements.	C5 The roof maintains traditional roofing materials of the area, such as glazed terracotta tiles. Any replacement or repair matches the original roofing in type, profile, colour and materials. Concrete roofing tiles and corrugated metal roofing are not appropriate.



<b>B3.8 Additional controls for development other than dwelling houses</b>	
<b>▶ 3.8.7 Inter-War flat buildings</b>	
<b>Objectives</b>	<b>Controls</b>
	<p>C6 Dormer windows or skylights are not visually prominent from the public domain or the principal elevations of the building.</p> <p>C7 Skylights are flush with the roof surface.</p> <p>C8 Original chimneys and their details are retained.</p>
<p>O6 To conserve the established garden settings, including significant elements and features.</p>	<p>C9 Characteristic front gardens, and their elements, are retained with minimal alteration.</p> <p>C10 Structures are not erected in the front garden that detract from the feeling of openness, or restrict or impact on the principal elevations of the building (including secondary fences and hedges).</p> <p>C11 Structures erected in the front garden do not significantly reduce or compromise the landscaped area or key elements and features.</p>
<p>O7 To ensure that parking does not detract from the character of the streetscape.</p>	<p>C12 Car parking and garage structures are located at the rear, with access from the rear lane or side driveway.</p>
<p>O8 To ensure that external alterations, additions and repairs do not detract from the original character and form of the building.</p>	<p>C13 External alterations and additions do not impact on the overall form and character of the building, and are not visually prominent from the public domain.</p> <p>C14 External windows and doors are repaired or replaced to match the style, materials and finishes of the original building.</p> <p>C15 Privacy screens are discreet and do not impact on the overall character of the building, and are visible from the street.</p> <p>C16 Protruding shade structures, including awnings and canopies, are not located on the principal building elevations.</p>

<b>B3.8 Additional controls for development other than dwelling houses</b>	
<b>▶ 3.8.7 Inter-War flat buildings</b>	
<b>Objectives</b>	<b>Controls</b>
	C17 Alterations to improve accessibility (including lifts, ramps and stairs) are sympathetically integrated with the original building and retain the original character and design of the building and landscape areas.
O9 To ensure that external materials, details and finishes respect and complement the original building.	<p>C18 Materials are similar in type and finish to those on the original building and sympathetically integrate with the fabric of the building.</p> <p>C19 Individual materials do not dominate the original materials of the building.</p> <p>C20 Original face brickwork, terracotta or decorative concrete panels must not be painted, rendered or coated.</p> <p>C21 Windows are timber double hung or casement with the glazing pane size to be conserved and match the original windows.</p> <p>C22 Original leadlight, glass blocks, etched and patterned glazing are retained and conserved.</p>
O10 To ensure that works to balconies and verandahs do not detract from the character and form of Inter-War flat buildings.	<p>C23 Original verandas and balconies to the principal elevation of the building are not enclosed, glazed, or otherwise altered, except to reinstate original detailing.</p> <p>C24 New verandahs and balconies are allowed to the rear or side elevations only if they: <ul style="list-style-type: none"> <li>a) respect the character of the existing building; and</li> <li>b) are sympathetically integrated with the character and form of the building.</li> </ul> </p>
O11 To ensure that fences, gates and mailboxes are consistent with the character of Inter-War flat buildings.	C25 Original fencing, gates and mailboxes are retained and conserved.

**B3.8 Additional controls for development other than dwelling houses**

▶ **3.8.7 Inter-War flat buildings**

Objectives	Controls
	<p>C26 Fences to the front building alignment are a height of between 400mm and 900mm. The height, style, form, materials and finishes match the principal building and the streetscape.</p> <p>C27 Gates are constructed in a height, style, form, materials and finishes to match the principal building and streetscape. Aluminium gates are avoided.</p> <p>C28 Fencing to side and rear boundaries is in the form of a timber paling fence.</p> <p>C29 Mailboxes are constructed in style, form, materials and finishes to match the principal building and streetscape.</p> <p>C30 Mailboxes are discreetly located and do not impact on the character of the building.</p>
<p>O12 To ensure that internal additions, alterations and repairs retain and respect internal common areas and significant internal character elements.</p>	<p>C31 Internal common areas and significant character elements are retained. This includes: entry doors, foyer areas and fittings, mailboxes, noticeboards, staircases, balustrades, carpets, wall details, light fittings, internal doors and the like.</p>
<p>O13 To ensure that the installation and maintenance of security devices does not detract from the character and form of Inter-War flat buildings.</p>	<p>C32 Original door and window hardware is retained, where practical. New additional security elements are in character with the building.</p> <p>C33 Security bars are:</p> <ul style="list-style-type: none"> <li>a) fitted internally;</li> <li>b) respect the existing glazing patterns; and</li> <li>c) painted in a dark recessive colour.</li> </ul>

**B3.8 Additional controls for development other than dwelling houses****▶ 3.8.7 Inter-War flat buildings**

Objectives	Controls
	<p>C34 Security intercom systems are discreetly located and in a style and materials complimentary to the character of the building.</p> <p>C35 Alarm bell boxes and the like, are not attached to the principal building elevations.</p>
<p>O14 To ensure that additions and alterations for fire upgrading and safety are discreet, and retain and respect the original and significant building fabric.</p>	<p>C36 New or upgraded services are discreetly and sensitively located to minimise visual impact.</p> <p>C37 New or upgraded services, such as rising mains and wiring, are located within existing ducts, behind cornices or bulkheads or within external lightwells that are not visually prominent.</p> <p>C38 Wiring or other services are housed in concealed conduits.</p> <p>C39 Original timber staircases are retained and smoke isolated, if necessary.</p> <p>C40 Where the height of the original stair balustrades is to be modified, the modification is discreet and sympathetically integrated with the existing stair balustrade.</p> <p>C41 Stair treads applied to existing stairs are discreet.</p> <p>C42 New lifts are designed and located so that the addition:</p> <ul style="list-style-type: none"> <li>a) is located outside the principal building form, if practical; and</li> <li>b) does not require significant alterations to existing common areas.</li> </ul> <p>C43 Existing original external and internal doors and door hardware are retained and upgraded rather than replaced.</p>

**B3.8 Additional controls for development other than dwelling houses**

**3.8.7 Inter-War flat buildings**

Objectives	Controls
	<p>C44 Existing original fanlights and other openings are retained and sealed from behind, if necessary.</p> <p>C45 Emergency and exit lighting is incorporated into existing original light fittings, where practical.</p> <p>C46 Smoke and/or thermal detectors are discreetly located and do not impact on decorative plaster cornices and ceilings.</p>
<p>O15 To ensure that ancillary development does not detract from the style and character of Inter-War flat buildings and their settings.</p>	<p>C47 Ancillary development, such as garages and laundries, constructed at the same time as the building are retained. Any modifications are sympathetic to the original building.</p> <p>C48 New ancillary development:</p> <ul style="list-style-type: none"> <li>a) is smaller in scale than the principal building;</li> <li>b) is not located between the principal building and the street front, and generally located at the rear behind the principal building;</li> <li>c) is constructed in a style, form, materials and finishes that complement the principal building;</li> <li>d) is single storey with a maximum clear internal height of 2.4m; and</li> <li>e) is sympathetic in scale and style to traditional forms of ancillary structures.</li> </ul>
<p>O16 To promote restoration and reconstruction works to restore significance.</p>	<p>C49 Previous unsympathetic additions and modifications to the building, and its grounds, are to be removed and replaced by reinstating original forms and matching fabric or with new works sympathetic to the age and style of the building.</p>

### B3.8.8 Post-1950s residential towers

The post-1950s residential towers are generally between 10 and 25 storeys high, and set on large sites with significant setbacks providing a garden setting to the street. These towers generally occur on the ridges of Darling Point and Point Piper and are visually prominent, particularly from Sydney Harbour.

#### B3.8 Additional controls for development other than dwelling houses

##### ▶ 3.8.8 Post-1950s residential towers

Objectives		Controls	
O1	To ensure that additions and alterations do not have an unsympathetic impact on the architectural style of the original building.	C1	Alterations and additions to post-1950s residential towers have regard to:
O2	To ensure that additions and alterations do not detract from the character of the area or have an unreasonable impact on surrounding properties.		<ul style="list-style-type: none"> <li>a) their visual prominence;</li> <li>b) impacts on views from public spaces;</li> <li>c) impacts on view sharing from private properties;</li> <li>d) the architectural integrity of the existing building; and</li> <li>e) the materials and finishes of the existing building.</li> </ul>

### B3.8.9 Non-residential development

A number of non-residential land uses, such as child care centres, community facilities, educational establishments and places of public worship are permitted within the residential zones.

Where a non-residential use is proposed, the development must be compatible with the desired future character of the area in terms of building scale, location and design, and the impacts arising from the use must not unreasonably compromise residential amenity.

Notes:

- ▶ On-site parking rates and design requirements are in Part E of the DCP, Chapter E1 Parking and Access.
- ▶ Additional controls are in Part F of the DCP, Chapters F1 Child Care Centres and Chapter F2 Educational Establishments.

B3.8 Additional controls for development other than dwelling houses	
▶ 3.8.9 Non-residential development	
Objectives	Controls
<p>O1 To ensure that non-residential development is consistent with the desired future character of the area and does not have an unreasonable impact on surrounding properties</p>	<p>C1 The built form complies with the building envelope, footprint, excavation and built form and context controls in Sections B3.2-B3.4.</p> <p>Note: The minimum side setback for non-residential development is determined by the table in Figure 5B and is measured at 90 degrees to the side boundary (refer Figure 4).</p> <p>C2 The development is compatible with the streetscape and the desired future character of the street. For example, buildings in residential areas must maintain a scale consistent with the streetscape.</p> <p>Note: Chapters B1 and B2 in this Part of the DCP define the desired future character for each precinct, and identify any special heritage, streetscape character and key elements within each precinct.</p> <p>C3 Lighting, noise, hours of operation, and intensity of the use do not unreasonably impact on the residential amenity of neighbouring properties, the street, or precinct.</p>

**B3.8 Additional controls for development other than dwelling houses****▶ 3.8.9 Non-residential development**

Objectives	Controls
	<p>C4 A management plan may be required to be submitted with the DA identifying the proposed uses on the site, and how the impacts of those uses will be managed and minimised. Matters that may need to be addressed in the management plan include:</p> <ul style="list-style-type: none"> <li>a) pedestrian and vehicular access;</li> <li>b) parking and servicing;</li> <li>c) capacity;</li> <li>d) hours of operation;</li> <li>e) lighting;</li> <li>f) noise; and</li> <li>g) security and safety.</li> </ul> <p>C5 For any non-residential development (including attached and detached garaging) the maximum volume of excavation permitted is no greater than the volume shown in Figure 13B.</p>

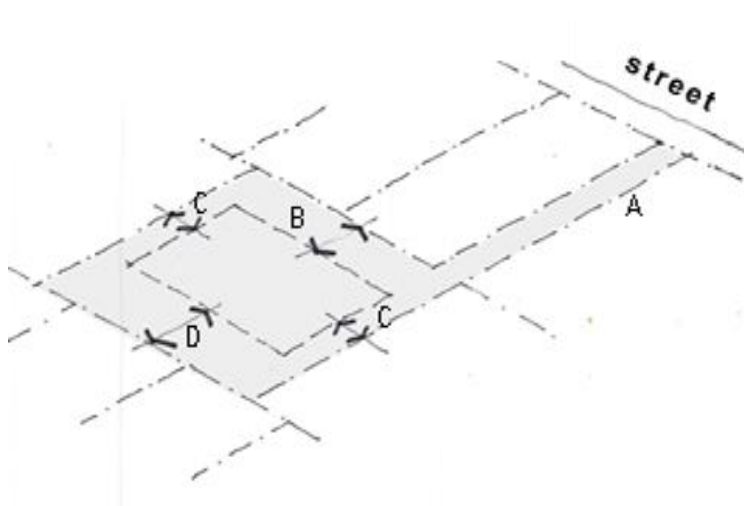


### B3.9 Additional controls for development on a battle-axe lot

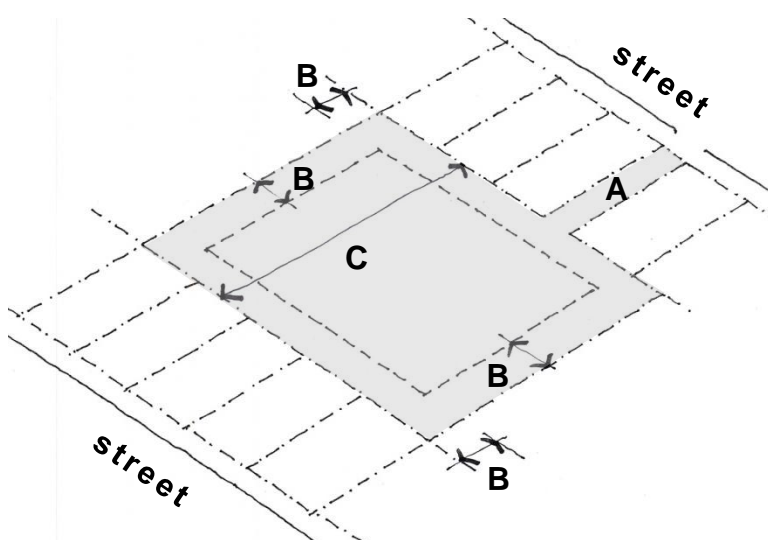
A battle-axe lot is a lot that is connected to a road by an access handle. It does not have a street frontage, and directly adjoins other properties at all boundaries.

The controls below recognise that development on battle-axe lots needs to particularly consider the amenity of both the occupants and the neighbouring properties, having regard to privacy, solar access, open space and the like.

Note, under Woollahra LEP 2014 the maximum height for development on a battle-axe lot is 9.5m.



**FIGURE 32**  
 Low density residential development (dwelling houses and dual occupancies)  
**A** = Access handle  
**B** = Primary frontage setback 6m from boundary  
**C** = Side setback 1.5m  
**D** = Rear setback 6m



**FIGURE 33**  
 R3 zone and development (other than a dwelling house, semi-detached dwelling or dual occupancy) must be on a site with a minimum area of 950m<sup>2</sup>  
**A** = Access handle  
**B** = 6m setback required to each boundary  
**C** = Minimum site dimension

B3.9 Additional controls for development on a battle-axe lot	
Objectives	Controls
O1 To ensure that the battle-axe lot is of a size that can provide for the amenity of occupants and neighbouring properties.	<p>C1 For development (other than a dwelling house, semi-detached dwelling or dual occupancy) in the R3 Medium Density Residential Zone—the minimum lot size is 950m<sup>2</sup>.</p> <p>C2 The lot, excluding the access handle, has minimum dimension in any direction, as follows:</p> <ul style="list-style-type: none"> <li>a) for a detached dual occupancy—21m</li> <li>b) for development involving three or more dwellings—24m.</li> </ul> <p>Note: The access handle of a battle-axe lot is included in calculating the lot size.</p>
O2 To ensure adequate building separation to provide for the amenity of occupants and neighbouring properties.	<p>C3 The setback controls in Figure 32 apply to development in the R2 Low Density Residential Zone, and any dwelling house or dual occupancy in the R3 Medium Density Residential Zone.</p> <p>Note: The primary frontage is the boundary closest to the access handle leading to the street.</p> <p>C4 For development in the R3 Medium Density Residential Zone (other than a dwelling house or dual occupancy) a 6m setback applies to all boundaries (refer to Figure 33).</p> <p>A reduced setback may be considered where there is no unreasonable impact on the amenity of neighbouring properties having regard to privacy, solar access, sense of enclosure and view sharing.</p>

**B3.9 Additional controls for development on a battle-axe lot**

Objectives	Controls
	<p>C5 Notwithstanding C3, a setback of 12m applies to:</p> <ul style="list-style-type: none"> <li>a) land at 327, 327C, 327D, 337, and 337A, Edgecliff Road (being Lot 4 DP 320118, Lot 1 DP 566991, Lot X DP 101456, Lot C DP 323192, and Lot 12 DP 851270,) and 14, 20, and 22 Roslyndale Avenue (being Lot 101 DP 738428, Lot 6 DP 9477 and Lot 7 DP 9477) along the eastern most boundary that directly adjoins R2 zoned land; and</li> <li>b) land at 345 Edgecliff Road (Lot E DP 331031) along the southern most boundary that directly adjoins R2 zoned land.</li> </ul> <p>Note: The 6m setback applies to all other boundaries.</p>

**B3.9 Additional controls for development on a battle-axe lot**

Objectives	Controls
<p>O3 To ensure that development does not unreasonably affect neighbouring properties in terms of privacy and sense of enclosure.</p>	<p>C6 Primary living areas, such as a living room, lounge room, kitchen and dining room, are located on the ground floor. Habitable rooms other than bedrooms, on the upper floors will only be considered where there is:</p> <ul style="list-style-type: none"> <li>a) no unreasonable impact on the privacy of neighbouring properties; and</li> <li>b) no overlooking into the private open space areas of neighbouring properties.</li> </ul> <p>C7 In the R2 zone, where habitable rooms other than bedrooms are located on the upper floor, the windows to these rooms are setback at least 4.5m from any boundary.</p> <p>C8 Balconies, decks and the like, on the upper floors will only be considered where there is:</p> <ul style="list-style-type: none"> <li>a) no unreasonable impact on the privacy of neighbouring properties; and</li> <li>b) no overlooking into the private open space areas of neighbouring properties.</li> </ul>

## B3.10 Additional controls for development in sensitive locations

### B3.10.1 Development on land adjoining public open space

This section applies to land that directly adjoins land zoned RE1 Public Recreation, C1 National Parks and Nature Reserves, and C2 Environmental Conservation.

Parks, reserves and other public open space areas contribute significantly to the amenity and well-being of the community.

Many of these areas are close to the harbour foreshore and provide an important contribution to scenic quality. Some of these parks and reserves contain remnant vegetation and ecological communities worthy of protection.

Development, including landscaping, on private property adjoining public open space areas needs to consider its relationship to the public land and be sensitively managed to minimise potential impacts on the amenity of these public open space areas.

B3.10 Additional controls for development in sensitive locations	
▶ 3.10.1 Development on land adjoining public open space	
Objectives	Controls
O1 To ensure that development on land adjoining public open space areas does not compromise the public use or amenity of the land.	C1 Development does not conflict with any plan of management applying to public land.
	C2 Development does not have an unreasonable impact on the public open space area in terms of: <ul style="list-style-type: none"> <li>a) overshadowing;</li> <li>b) scale or sense of enclosure; and</li> <li>c) loss of significant views.</li> </ul>
	C3 Fencing and landscaping along any common boundary makes a positive contribution to the public open space area.
O2 To improve opportunities for passive surveillance into public open space areas.	C4 Where practical, the building is designed to have an outlook to the adjoining public open space area.
O3 To protect and enhance public access to public open spaces.	C5 Development does not reduce existing public access to public open space areas. When possible, development increases opportunities for public access.

**B3.10 Additional controls for development in sensitive locations****▶ 3.10.1 Development on land adjoining public open space**

Objectives		Controls	
O4	To ensure that development does not have an adverse impact on the ecology of adjoining parks, reserves or other public open space areas.	C6	A gate or the like, providing direct access from a private property to the public park or reserve opens inward toward the private property and does not encroach on public land.
O5	To ensure that development adjoining open space provides for a continuation and support of native vegetation and habitat areas.	C7	For new plantings, 90% of the plants in the landscape design are native species. However, where the land adjoins bushland to which <i>Chapter 2 (Vegetation in Non-Rural Areas), of the State Environmental Planning Policy (Biodiversity and Conservation) 2021</i> applies, 100% of the plants are locally occurring native species.
O6	To ensure that development does not impact on the environmental processes of the public land, such as soil erosion, siltation, and the like.	C8	Landscaping provides a diversity of native species and a complexity of habitat through vertical layering.  Note: Refer to the DA Guide for suggested vegetation species.

---

## B3.10.2 Harbour foreshore development

---

Sydney Harbour is an outstanding natural and public asset of national significance with unique environmental qualities that are world renowned. Woollahra Council has a shared responsibility with the State government and other councils with harbour foreshore land to ensure its protection for existing and future generations.

Chapter 6 Water Catchment of the State Environmental Planning Policy (Biodiversity and Conservation) 2021 (Biodiversity and Conservation SEPP) provides clear planning framework and better environmental outcomes for Sydney Harbour. The Biodiversity and Conservation SEPP applies not only to the waterways and foreshores of the harbour, but to the wider hydrological catchment.

The provisions in this part of the DCP supplement the Biodiversity and Conservation SEPP, and particularly address scenic and environmental protection issues. These DCP provisions apply to:

- ▶ land that has a boundary to the Sydney Harbour foreshore;
- ▶ land adjoining the Sydney Harbour foreshore which is zoned C1 National Parks and Nature Reserves or RE1 Public Recreation; and
- ▶ any land visible from Sydney Harbour.

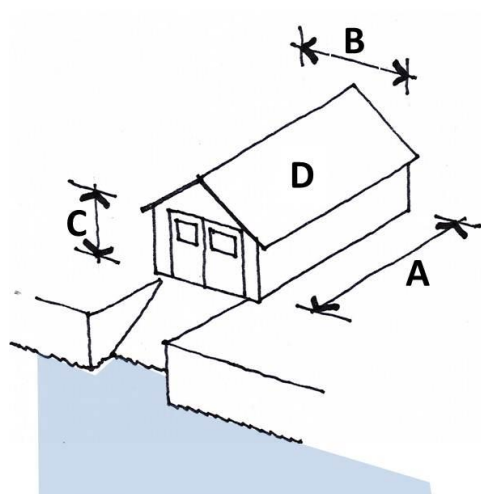
### Scenic protection

The appearance of development when viewed from Sydney Harbour is an important consideration for development.

Scenic protection is not just relevant to land immediately adjacent to the foreshore, but applies to development on any land that is visible from Sydney Harbour. This is because building form, scale, materials and vegetation cover of development located along the slopes and ridgelines visible from the harbour are also important in contributing to, and protecting, the harbour's scenic qualities.

### Ecological communities and protection of the natural foreshore

The harbour foreshore supports a vast array of flora and fauna communities. It is important to minimise the impact of development to preserve natural ecosystems and protect the natural foreshore character.

**FIGURE 34**

Design considerations for boat sheds

A = Maximum length 5m

B = Maximum width 3.7m

C = Maximum wall height 2.5m

D = Minimum roof pitch 30°

**B3.10 Additional controls for development in sensitive locations**

## ▶ 3.10.2 Harbour foreshore development

Objectives	Controls
O1 To protect the scenic quality of the natural landscape and built environment, particularly as viewed from Sydney Harbour.	C1 Development as viewed from Sydney Harbour follows the natural topography and maintains or enhances vegetation cover.  C2 Roofs are below the tree canopy and maintain the prominence of the treed skyline.  C3 Development as viewed from Sydney Harbour, is designed and constructed to blend with the natural landscape setting and the existing built environment through the use of materials, colours, wall articulation, building form and landscaping. Glass elevations and excessive use of windows resulting in reflectivity and glare are avoided.  C4 Pergolas, boatsheds, other outbuildings and structures are designed and constructed to complement the overall appearance of the development. Such structures are no more than one storey in height.  C5 Swimming pools and spa pools are not elevated more than 1.2m above ground level and complement the character of the harbour and foreshore.  C6 Swimming pool and spa pool walls are suitably treated to complement the natural foreshore,



**B3.10 Additional controls for development in sensitive locations**

▶ **3.10.2 Harbour foreshore development**

Objectives	Controls
	and where visible, are sandstone clad and incorporate suitable screen landscaping.
	C7 The boatshed is designed to directly relate to the water, with openings and access facing the water.
	C8 Boatsheds are used solely for the storage and/or maintenance of boats.
	C9 Boatsheds have maximum plan dimension of 6m x 3.7m. Boatsheds are sited so that the minimum dimension fronts the harbour (refer to Figure 34).
	C10 Boatsheds incorporate gable pitched roofs with a minimum pitch of 30°. The use of roofs as sundecks, patios or the like is not permitted (refer to Figure 34).
	C11 Boatsheds are single storey and have a maximum wall height of 2.5m (refer to Figure 34).
	C12 Boatsheds are constructed of stone or timber. Excessive use of glazing is avoided.
	C13 Jetties are constructed of hardwood, are of minimum size and are designed to be as unobtrusive as possible. The sharing of jetties between properties is encouraged and, where possible, jetties are constructed on common boundaries to limit the proliferation of structures along the foreshore.

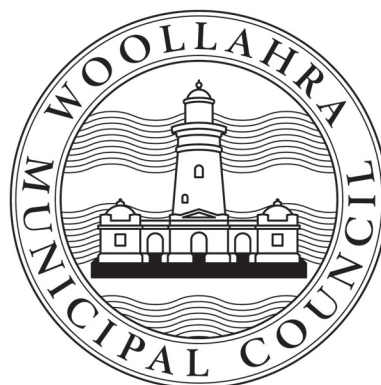
**B3.10 Additional controls for development in sensitive locations****▶ 3.10.2 Harbour foreshore development**

Objectives	Controls
<p>O2 To minimise impacts on natural coastal processes, including sea level rises and flooding.</p>	<p>C14 Boundary fences are not permitted within 8m of the mean high water mark.</p> <p>C15 Within the foreshore area:</p> <ul style="list-style-type: none"> <li>a) fences are not more than 1.5m in height above the existing ground level, and are constructed of open weave materials (such as wire or lattice to enable vines, creepers or hedges) to provide natural cover;</li> <li>b) boundary planting is not higher than 1.5m when fully mature; and</li> <li>c) hard surfaces and artificial surfaces, such as paving, are minimised and generally limited to swimming pool surrounds or modest walkways between the residential building and foreshore structures, such as swimming pools or boat ramps.</li> </ul> <p>Note: Foreshore area means the land in foreshore area 12 and 30 in Woollahra LEP 2014.</p>
<p>O3 To protect natural habitats and minimise disturbance on ecological communities.</p>	<p>C16 Development on foreshore properties maintains or reduces current levels of site stormwater or sediment run-off entering the harbour.</p> <p>C17 Development is not located within seagrass communities and avoids shading of seagrass communities.</p> <p>C18 Development and construction does not disturb seabed contaminants.</p> <p>C19 The existing tree canopy is maintained or enhanced.</p>

**B3.10 Additional controls for development in sensitive locations**

▶ **3.10.2 Harbour foreshore development**

Objectives	Controls
<p>O4 To reinforce the natural character of the foreshore and limit disturbance to the natural land and water interface.</p>	<p>C20 Development on foreshore properties does not significantly alter the topography and preserves natural foreshore features including cliffs, rock outcrops, rock shelves and beaches.</p> <p>C21 Seawalls or retaining walls are not permitted in areas where the foreshore is in its natural state.</p> <p>C22 Where seawalls or retaining walls are permitted, these are:</p> <ul style="list-style-type: none"> <li>a) constructed of coarse, rock-faced stone or with stone facing (preferably sandstone);</li> <li>b) no more than 1m above the mean high water mark; and</li> <li>c) be designed and built to improve the environmental value of seawalls and seawall-lined foreshores (refer to Environmentally Friendly Seawalls: A Guide to Improving the Environmental Value of Seawalls and Seawall-lined Foreshores in Estuaries, published by the Department of Environment and Climate Change NSW on behalf of Sydney Metropolitan Catchment Management Authority).</li> </ul> <p>C23 Slipways and stairs are designed and constructed to closely conform to the character of the natural foreshore.</p>



## Part C ► Heritage Conservation Areas

WOOLLAHRA DEVELOPMENT CONTROL PLAN 2015



# Chapter C1 Paddington Heritage Conservation Area

Part C ► Heritage Conservation Areas

CHAPTER C1 APPROVED ON 27 APRIL 2015  
AND COMMENCED ON 23 MAY 2015

Last amended on 31 May 2024



# Chapter C1 ► Paddington HCA

## Contents

<b>C1.1</b>	<b>INTRODUCTION .....</b>	<b>1</b>
	C1.1.1 Background.....	1
	C1.1.2 Land where this chapter applies .....	2
	C1.1.3 Development to which this chapter applies.....	3
	C1.1.4 Objectives .....	3
	C1.1.5 Relationship to other parts of the DCP.....	3
	C1.1.6 Definitions.....	4
	C1.1.7 How to use this chapter.....	5
<b>C1.2</b>	<b>UNDERSTANDING THE CONTEXT .....</b>	<b>7</b>
	C1.2.1 The significance of the Paddington Heritage Conservation Area .....	7
	C1.2.2 Building types in Paddington.....	8
	C1.2.3 Character elements.....	8
	C1.2.4 Desired future character .....	11
	C1.2.5 Contemporary design in Paddington .....	12
<b>C1.3</b>	<b>BUILDING TYPES .....</b>	<b>13</b>
	C1.3.1 Single storey buildings .....	14
	C1.3.2 Timber buildings .....	22
	C1.3.3 Corner buildings .....	24
	C1.3.4 Multi-storey terrace style housing .....	26
	C1.3.5 Dwelling houses .....	27
	C1.3.6 Residential flat buildings, manor houses, multi dwelling housing and multi dwelling housing (terraces).....	28
	C1.3.7 Buildings in the William Street MU1 Mixed Use Zone .....	32
	C1.3.8 Commercial and industrial buildings including shops.....	34
	C1.3.9 Pubs .....	41
	C1.3.10 Places of public worship and educational establishments .....	44
	C1.3.11 Public buildings .....	45
	C1.3.12 Existing contemporary infill .....	46
	C1.3.13 Infill development (new development).....	47
	C1.3.14 Intrusive buildings .....	55
<b>C1.4</b>	<b>GENERAL CONTROLS FOR ALL DEVELOPMENT .....</b>	<b>56</b>
	C1.4.1 Principal building form and street front zone of contributory buildings.....	57
	C1.4.2 Side elevations and side additions .....	62
	C1.4.3 Rear elevations, rear additions, significant outbuildings and yards .....	67
	C1.4.4 Roofs and roof forms .....	71
	C1.4.5 Building height, bulk, form and scale .....	73
	C1.4.6 Site coverage, setbacks and levels.....	75
	C1.4.7 Excavation.....	77
	C1.4.8 Private open space, swimming pools, courtyards and landscaping .....	82
	C1.4.9 Views .....	87
	C1.4.10 Acoustic and visual privacy .....	88



---

C1.4.11 Land subdivision and site amalgamations .....	90
<b>C1.5 SPECIFIC POLICY FOR BUILDING AND SITE ELEMENTS .....</b>	<b>91</b>
C1.5.1 Dormers and skylights .....	92
C1.5.2 Chimneys .....	96
C1.5.3 Windows, doors, shutters and security.....	98
C1.5.4 Verandahs and balconies .....	101
C1.5.5 Fences, walls and gates.....	104
C1.5.6 On-site vehicle parking, garages, carports, driveway access and servicing facilities 109	
C1.5.7 Lofts over garages and studios.....	117
C1.5.8 Materials, finishes and details .....	119
C1.5.9 Exterior colours .....	126
C1.5.10 Gardens and trees .....	128
C1.5.11 Satellite dishes, aerials, air conditioning units and other site facilities.....	129
<b>C1.6 PUBLIC DOMAIN .....</b>	<b>132</b>
C1.6.1 Kerbs and gutters .....	132
C1.6.2 Views and vistas .....	134
C1.6.3 Public art .....	133
<b>APPENDIX 1: ORIENTATION OF LOTS IN THE PADDINGTON HCA .....</b>	<b>134</b>

## C1.1 Introduction

### C1.1.1 Background

Paddington is a unique urban area of outstanding national heritage significance and the conservation of Paddington and its heritage significance should be the foremost outcome of development.

The special character of Paddington is derived from its historical development and associations. This unique character is also evident in its interrelationship of buildings, spaces, topography, landscape settings and land uses. Paddington's sense of place and its significance results from a multi-layered interrelation of various built forms and spaces and historical and social values.

Paddington needs to be understood as a whole precinct. Some of the individual buildings and sites within the precinct are heritage items, however all other buildings (except for intrusive buildings) are contributory buildings as they make a positive contribution to the character of the area. For Paddington, the whole is greater than the sum of its parts.

Paddington is a living place which will continue to undergo change; appropriate contemporary design is encouraged and necessary if change is to occur in a manner which respects the significant characteristics of Paddington.

#### Conservation philosophy

The controls for the Paddington Heritage Conservation Area (HCA) contained in this chapter are based on the Paddington Heritage Conservation Area DCP 2008. The Paddington Heritage Conservation Area DCP 2008 was the culmination of a review of the Paddington DCP 1999. The review of the Paddington DCP 1999 included input from a working party comprising representatives from The Paddington Society, the National Trust of Australia (NSW), the Woollahra History and Heritage Society, the NSW Heritage Office and Woollahra Councillors.

This chapter of the DCP adopts the conservation philosophy embodied in the Australia ICOMOS Charter for the Conservation of Places of Cultural Significance (the Burra Charter).

The Burra Charter is widely accepted by Government agencies at all levels and by private industry as the standard philosophy for heritage conservation practice in Australia. The Charter sets down principles, processes and practices for the conservation of significant places. Certain terms used in the Burra Charter are also used in this chapter and are defined in Section C1.1.6.

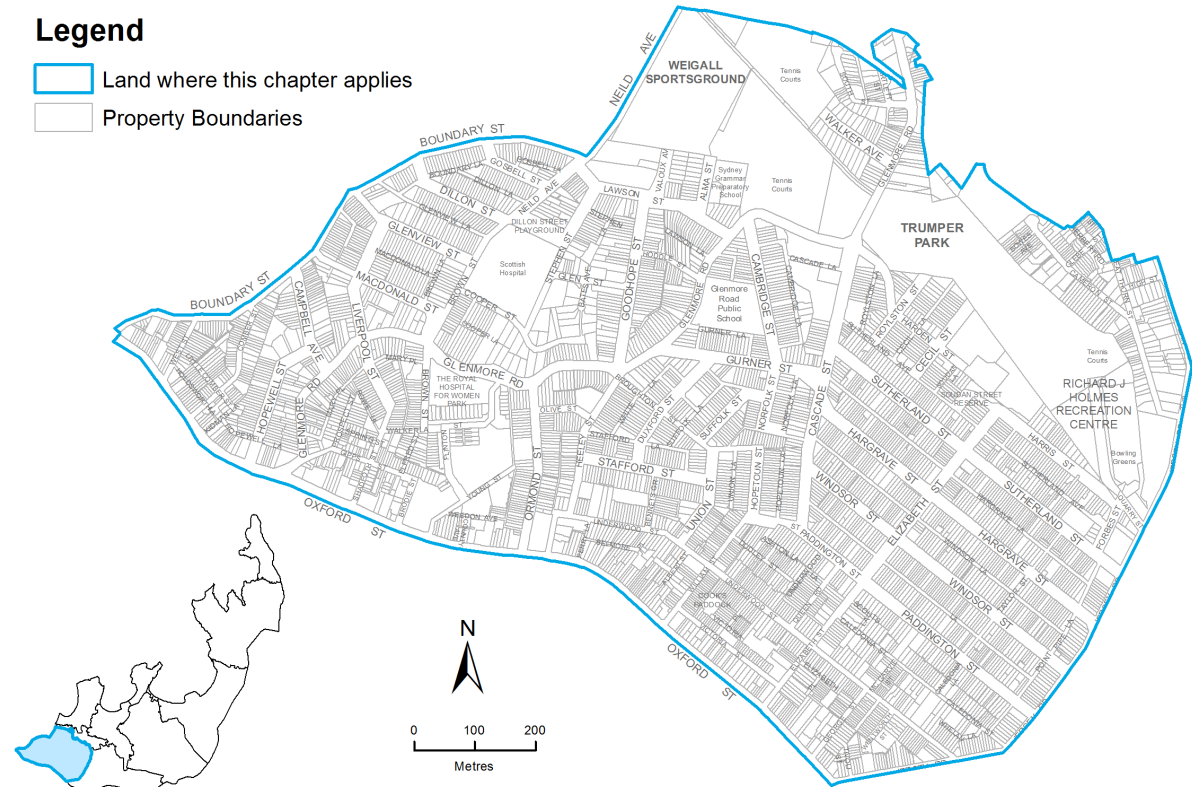
Note: The term 'original' as used throughout the DCP refers to any significant fabric. This may be from a range of historic periods.

### C1.1.2 Land where this chapter applies

This chapter applies to the Paddington HCA as identified in Map 1.

Parts of the suburbs of Edgecliff and Woollahra are located in the Paddington HCA; this chapter applies to those parts.

MAP 1 Paddington Heritage Conservation Area boundary map



---

### C1.1.3 Development to which this chapter applies

---

This chapter applies to development that requires consent under Woollahra Local Environmental Plan 2014 (Woollahra LEP 2014).

Generally this will be residential or commercial development, but may include other permitted uses such as child care centres, community facilities, educational establishments and places of public worship.

### C1.1.4 Objectives

---

The objectives of this chapter are:

- O1 To facilitate the implementation of the objectives and provisions relating to heritage conservation contained in Woollahra LEP 2014.
- O2 To acknowledge and conserve the unique National heritage significance of Paddington.
- O3 To conserve the significant types of buildings within the Paddington Heritage Conservation Area.
- O4 To provide guidelines and controls which seek to protect the significant character of Paddington and which encourage contemporary design which responds appropriately to that character.
- O5 To encourage and promote public awareness, appreciation and knowledge of heritage conservation.
- O6 To enhance amenity and heritage values within Paddington.
- O7 To ensure that development is consistent with the heritage significance of the Paddington Heritage Conservation Area.

### C1.1.5 Relationship to other parts of the DCP

---

This chapter is to be read in conjunction with the other parts of the DCP that are relevant to the development proposal, including:

- ▶ Part B: Chapter B3 General Development Controls, but only if the proposal is for a dual occupancy development (refer to Section B3.8 Additional controls for development other than dwelling houses).
- ▶ Part E: General Controls for All Development - this part contains chapters on Parking and Access, Stormwater and Flood Risk Management, Tree Management, Contaminated Land, Waste Management, Sustainability, Signage and Adaptable Housing.
- ▶ Part F: Land Use Specific Controls - this part contains chapters on Child Care Centres, Educational Establishments, Licensed Premises and Telecommunications.

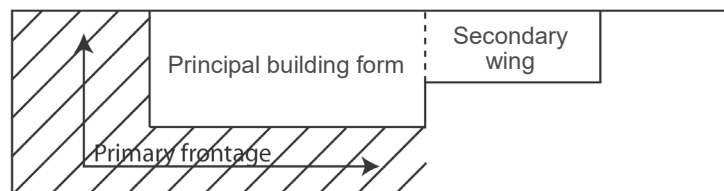
## C1.1.6 Definitions

---

The definitions below define words and expressions for the purpose of this chapter.

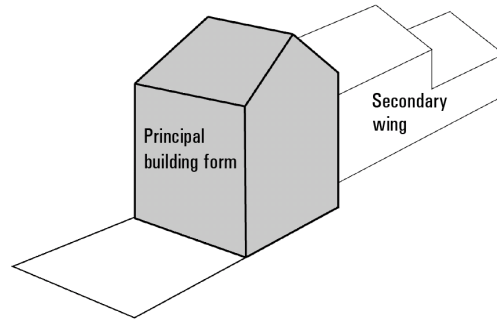
These definitions apply in addition to the definitions in Part A Chapter A3 of the DCP, the Environmental Planning and Assessment Act and Woollahra LEP 2014.

<b>ancillary development</b>	a building or structure, other than a dwelling house, dual occupancy, semi-detached dwelling, mixed development, attached housing, multi-dwelling housing, residential flat building, manor housing, multi dwelling housing (terraces) or other housing type, but including sheds, pool houses, detached garages, gazebos, separate laundries, pagodas, swimming pools and pergolas.
<b>balconet</b>	is an area incorporating a guard rail only and a very minor projection from the outer wall of a building, fronting windows with deep sashes or inward opening doors, preventing people from falling.
<b>breezeway</b>	an unenclosed passage or void between the side boundary and rear wing.
<b>missing elements</b>	based on known evidence, including where the missing elements exist to related properties rather than speculation).
<b>primary frontage (corner lots)</b>	that part of the site in the street front zone and the part between the side street and the principal building form (see diagram).



**principal building form**

the original front building section and main roof, which contains the main rooms (see diagram).



### C1.1.7 How to use this chapter

The provisions of this chapter are to be used by applicants in the sequence set out below.

**TABLE 1** How to use this chapter

Steps to be considered for all development	
<b>Step 1</b>	<p><b>Understanding the context</b></p> <ul style="list-style-type: none"> <li>▶ Read the statement of significance for the Paddington HCA in Section 1.2.1.</li> <li>▶ Read the desired future character statement for the Paddington HCA in Section 1.2.4.</li> <li>▶ Development is to achieve the outcomes expressed in the desired future character statement. Applications will be assessed against their ability to satisfy those outcomes relevant to the proposal, amongst other matters.</li> </ul>
<b>Step 2</b>	<p><b>Investigating heritage significance</b></p> <ul style="list-style-type: none"> <li>▶ Identify whether the subject building or site is a heritage item as identified in Woollahra LEP 2014.</li> <li>▶ All other buildings within the Paddington HCA are ‘contributory buildings’ as they make a positive contribution to the character of the area. The only exception to this is for ‘intrusive buildings’ which are inappropriate to the character of Paddington in regard to scale, proportions, materials and design.</li> <li>▶ Consider the history and relationship of the subject site and surrounding sites, having particular regard to the building type/s to which the development applies. The history and relationships are to be conserved.</li> <li>▶ Identify the key building fabric relevant to the building type and the site. Original key fabric is to be conserved.</li> </ul>

**Step 3 Addressing the objectives and controls**

For all development, each section must be read and the relevant controls applied:

- ▶ Section C1.3 Building types: There are 14 building types, each with specific objectives and controls. Note, more than one building type may apply to your development.
- ▶ Section C1.4 General controls for all development. This section applies to all development including existing buildings and infill development.
- ▶ Section C1.5 Specific policy for building and site elements: Specific controls for building and site elements on residential and non-residential buildings.
- ▶ Section C1.6 Public domain: Applies to land owned and/or managed by Council or other public authorities.

## C1.2 Understanding the context

### C1.2.1 The significance of the Paddington Heritage Conservation Area

Paddington is a unique urban area which possesses historical, aesthetic, technical and social significance at a National and State level. An important factor in the significance of Paddington is its exceptional unity, encompassing scale, character, history, architecture and urban form.

The built environment of Paddington is an excellent example of the process of 19th century inner city urbanisation of Sydney which was largely completed by 1890. The predominant Victorian built form is an excellent representative example of the phenomena of land speculation and a 'boom' building period between 1870 and 1895.

The terraces of Paddington clearly trace the evolution of the imported English Georgian and Regency terrace models into the distinct Australian style evident in the Victorian era terraces.

Paddington retains many significant types of buildings that represent all phases of the suburb's historical development. These building types range from modest, small-scale, single storey timber and masonry cottages, to remnant examples of former gentry mansions, boom style middle-class terrace houses, apartment blocks and contemporary infill development, all of which are set in a varied network of streets, lanes and pedestrian accessways which reflect the phases of subdivision and development.

Paddington has a multitude of important historical and social associations. It is linked with the early transport routes along South Head Road (Oxford Street) and Point Piper Road (Jersey Road), the construction of Victoria Barracks in the 1840s, the gentry estates, prominent figures of the early colony, the speculative building boom between 1870 and 1890, and the development of Australian tennis at the White City site. Its historical and social associations extend to the periods of occupancy by immigrant groups and minority groups including the Chinese market gardeners, the Jewish community around the turn of the century, the European immigrants in the 1950s and an alternative artistic and intellectual population in the 1960s and 1970s. Today Paddington has a high level of social esteem and is regarded as one of Sydney's most desirable inner-city urban areas. The changing sociology of Paddington demonstrates phenomenal variations in status and changes in community attitudes to the 19th century suburb.

Paddington has important associations with the evolution of the conservation movement in Australia, in particular with the actions by the National Trust and the Paddington Society, which ensured its conservation at a time of redevelopment threat in the 1960s. It is significant as the first suburb classified by the National Trust, a community based, non-government organisation committed to promoting and conserving Australia's heritage.

Paddington has a unique aesthetic significance due to the superimposition of the built form on a sloping topography which overlooks Sydney Harbour and its foreshores. The coherent and extensive Victorian built form comprising groups of terrace buildings on narrow allotments which step down hills, turn corners or sit in ranks along tree lined streets produces a singularly recognisable image.

Inter-War flat buildings are also present in Paddington, ranging from around 1918 to circa 1950. Many of these buildings make an important historic, aesthetic, social and representative



---

contribution to the character and illustrate the historical evolution of development of the area. They demonstrate the key characteristics of architectural styles of the Inter-War period.

Paddington provides vast opportunity for research, education and interpretation through the physical layout of its road network, its subdivision pattern and the varied form of buildings.

These buildings provide an excellent record of past technologies and domestic lifestyles through features such as original external and internal building fabric, detailing and room layouts. Terrace houses, semi-detached dwellings, flat buildings and freestanding houses all show the evolving attitudes towards families and the home from the early 19th to the late 20th century.

### C1.2.2 Building types in Paddington

---

The built environment of Paddington reveals the historic development of the area. Building types and styles exemplify stages of development and support the overall cultural significance of the area.

Examples of the 1840 to 1870 phase of development include small workers' cottages and boldfaced terraces from the original Paddington village, and grand mansions from the large gentry estates built along the ridgelines, such as Juniper Hall. Rows of Victorian boom style terraces were built between 1870 and 1910 on the subdivisions of the early land grants and large estates.

Later development which occurred on further subdivisions, vacant blocks, or on redeveloped sites includes Federation era terraces, Inter-War flat buildings, 1960s and 1970s high rise style units, and more recently some excellent examples of contemporary infill.

The building types most commonly found in Paddington include multi-storey and single-storey terrace house rows, single-storey timber and masonry houses, freestanding houses, mixed commercial and residential buildings, commercial and industrial buildings, pubs and contemporary infill buildings. To ensure that development proposals recognise and respect the particular characteristics of particular building types, Section C1.3 of this chapter sets out specific objectives and controls for these and other building types.

### C1.2.3 Character elements

---

The character elements represent the distinguishing features of the area that are to be retained. Applications to change the character elements will be assessed against the desired future character controls.

#### Introduction

Paddington has a valuable historic and predominantly 19th century residential character, which is represented by late-Victorian terrace houses, modest workers' cottages, including single-storey timber and masonry houses, and former mansions. It also contains a mix of shops and pubs, residential flat buildings, commercial buildings and a few surviving light industrial and warehouse buildings, with many being adapted to residential uses.

---

---

To protect the heritage significance of Paddington it is important to retain and conserve the many building types that represent the significant phases of the suburb's historical development. These are important buildings and many have original outbuildings, fences and garden settings that are important elements to preserve.

Other townscape features such as significant trees and historical sandstone kerbs and gutters also contribute to the significance of the Paddington HCA.

It is particularly important to conserve the significant fabric and layout of the original front building section which contains the main rooms. This section, including its roof, is referred to as the "principal building form", and commonly faces the street front, with a secondary section behind. The main rooms often contain the most significant details such as plaster work, timber joinery and fireplace surrounds.

Many terrace houses have a small setback from the street. This area, referred to as the "street front zone", provides an important setting for buildings. The setting for freestanding buildings, including timber cottages, is established with their front, side and rear setbacks.

Additions and alterations to existing buildings and the construction of new buildings should be designed with respect to the architectural character of the building and the context of the significant streetscapes of the Paddington HCA. Retention of original fabric and detail is key.

Reconstruction and reinstatement of missing details and building elements is important and encouraged. This includes the removal of inappropriate building elements.

Even small changes to buildings in Paddington require careful consideration. This is critical when changes are visible from the street or from other public spaces.

Alterations to the rear of properties require detailed consideration so as not to alter the proportion, scale and the cohesion in groups of buildings. Due to the topography and the subdivision patterns, rear elevations are often highly visible from the public domain.

In Paddington, the aim should always be to establish a cohesive relationship between new work and the existing building fabric. Contemporary design must respond appropriately to relevant aspects of the historical context.

### Natural and built character elements

The existing distinguishing natural and built character elements of the Paddington HCA include:

- ▶ A topographical form which is shaped into a natural amphitheatre facing north over flatlands and former swamps allowing views to Rushcutters Bay, Sydney Harbour and westwards to the city. This land form also enables internal views of secondary ridges and gullies.
- ▶ A variable and intricate street, lane and pedestrian network. The western side of Paddington, originally the Paddington Village, is characterised by short, angled narrow roads with closed vistas and dogleg junctions influenced by the boundaries of early land grants. Dense rows of cottages and terrace housing often have zero setback.

Later street patterns in the eastern half of Paddington were laid out in the Victorian building boom period. The subdivisions are more strictly ordered with alternating wide streets and rear lanes and are set out on a rectangular grid. Development on corner sites is usually

sensitive to the pivotal position they occupy in both streetscapes. Streets provide long vistas. Road surfaces are asphalt and kerbing and guttering is a mix of sandstone and concrete.

- ▶ A strong pedestrian character which is reflected in the multitude of passageways, rear and side interconnecting lanes, narrow streets and intermix of residential and non-residential uses. Footpath pavement material is a mixture of asphalt, fly ash concrete and modern concrete.
- ▶ A land use character which is predominantly residential but which also contains a mix of shops and pubs (often located on corners), some commercial buildings, and a few remaining light industrial and warehouse style buildings.
- ▶ Evidence of the evolution of building styles which reflect historical patterns of growth and land use.
- ▶ Terrace housing which forms continuous facades along the streets and steps down the hillside.
- ▶ Modest housing forms such as single-storey timber and masonry cottages.
- ▶ Variable building heights between terrace groups, one-off buildings and different building types, including timber and masonry cottages.
- ▶ Terrace housing, predominantly in distinguishable groups, which displays similar character in terms of form but variation in architectural styles, surface decorative details, verandahs and balcony design, window, door, roof forms and chimney treatments.
- ▶ A strong contrast between the formal and frequently more decorative front of the terrace to the street and the simple and utilitarian back of the terrace.
- ▶ A street front which in many terraces is characterised by a cast iron palisade fence returning to form side party fencing, a small front garden and path, recessed verandah on the ground floor and balcony on the upper level enclosed by a cast iron balustrade. Other terraces have only a small setback from the street, no front garden, and a cast iron fence to the verandah. Some terraces are built to the front boundary and have an upper floor balcony which cantilevers the footpath. Many Victorian boom style terraces terminate with a street front parapet.
- ▶ Some laneways which retain culturally significant fabric including paling fencing, pedestrian gates, brick lavatories and backyard planting.
- ▶ A restricted palette of materials including stone, painted stucco, cast iron and tessellated tiles, corrugated roof materials and slate, nearly universal to all street frontages.
- ▶ A perceived homogeneity of a Victorian era terrace built form which on close examination is made up of a diversity of building types reflecting the historical development of Paddington.
- ▶ A variety of open space and landscape features which are represented in:
  - flatland parks and playing fields - Trumper Oval, Weigall Sportsground, White City;
  - escarpment areas - Trumper Park;
  - public open space created by street closures;
  - early municipal street tree plantings;
  - pocket parks often created on gap sites within the terrace streetscape;
  - remnant established gardens from earlier gentry estates such as the former Scottish Hospital grounds;

- 
- private open space within institutions - Sydney Grammar's Weigall Grounds, White City; and
  - private gardens which contribute significantly to the townscape quality of streets and laneways.

### C1.2.4 Desired future character

---

The desired future character is a vision statement about the future image and function of the Paddington HCA. Applications will be assessed, among other matters, against their ability to satisfy those outcomes relevant to the development proposal.

This chapter seeks to achieve a desired future character for the Paddington HCA which:

- a) retains the unique national heritage significance of Paddington and recognises it as a rare and distinctive urban area;
- b) reinforces the area as a special residential precinct;
- c) retains and promotes evidence of the historical development of the area and enables interpretation of that historical development;
- d) retains the cohesive character evident in the low scale, high density built form;
- e) retains distinctive features such as parapets, chimneys, mixture of roofs, complex of roads, laneways and alleyways, consistency of colours, subdivision patterns and buildings which follow the landform and the distinctive patterns of terrace house groups;
- f) continues to cater for varied uses and building types within the residential area;
- g) retains the diversity of building types including multi-storey and single-storey terrace house rows, modest scale timber and masonry cottages, semi-detached dwellings, dwelling houses, commercial buildings, pubs, former industrial buildings, places of public worship, Inter-War flat buildings and public buildings;
- h) enables people to walk or cycle to shops, public transport, schools, parks and entertainment facilities in a safe, pleasant and healthy environment;
- i) provides attractive and vibrant shopping areas for locals and tourists;
- j) provides for sharing of views and vistas; and
- k) exhibits contemporary design excellence.

As Paddington is a living place and will be subject to change over time, Council seeks to encourage new development of a high design standard which respects the significance of the area.

The statement below on contemporary design emphasises the role that modern day design plays in the evolution of Paddington. Issues of contemporary design are relevant to development in the public and private domains.

---

### C1.2.5 Contemporary design in Paddington

---

Contemporary design provides the basis for the continuing enrichment of the historic interpretation of Paddington by adding to our understanding of contemporary life as expressed in the built environment. Issues of contemporary design are relevant to new development of a minor and major nature in the both the public and private domains. Quality architectural design must form the basis of any proposed new works. Contemporary design must be respectful of the HCA.

Paddington is characterised by rows of 19th century buildings. Paddington has a number of significant buildings and building elements that represent the changing character of design from the 19th century-21st century. The presence of buildings and building elements representing the various design elements of the 20th and 21st centuries enrich the character of Paddington and the interpretative aspects of its history.

A range of contemporary design approaches, philosophies and techniques can be employed in Paddington. These are encouraged in appropriate locations and circumstances.

Council does not advocate replication of previous architectural styles in cases of infill development. However, infill development should be based on a contemporary design approach which respects the context, especially the predominant scale, form and articulation of buildings that characterise an area. New contemporary design should respect the historic built form of the Paddington HCA.

Certain types of new work require a traditional design approach. Such an approach may be appropriate where alterations and additions are proposed for those areas of a building which have original significant fabric.

A thorough understanding of the physical and historical aspects of the site and its context will act as a guide to the appropriateness of the design approaches. Applicants must demonstrate that contemporary design techniques, materials or idioms provide an appropriate response to relevant aspects of the physical and historical context. Applications are required to demonstrate that contemporary design techniques, materials and design elements provide an appropriate response to the relevant aspects of the historical and physical context.

The use of contemporary design approaches, particularly to infill development, work to an intrusive building, work to the public domain, and work to buildings or building elements of heritage significance, must achieve a cohesive relationship between new and existing urban fabric, and respect and respond to the context of the HCA.

## C1.3 Building types

To protect the heritage significance of Paddington it is important to retain and conserve the many building types that represent the significant phases of the suburb's historical development.

The applicant is to identify which of the building types listed below are relevant to the proposal, and comply with the objectives and controls for those building types.

Where development involves an existing building, more than one building type control may apply. For example:

- ▶ for single storey dwellings— the building type controls for single storey buildings and dwelling houses apply;
- ▶ for a single storey corner shop— the building type controls for single storey buildings, corner shops and corner commercial buildings, and commercial and industrial buildings apply;
- ▶ for a single storey freestanding dwelling house— the building type controls for single storey buildings and dwelling houses apply.

### Building types

The building types in this section are:

- ▶ 1.3.1 Single storey buildings (applies to residential and non-residential buildings)
- ▶ 1.3.2 Timber buildings
- ▶ 1.3.3 Corner buildings:
  - Corner terrace houses
  - Corner shops and corner commercial buildings
- ▶ 1.3.4 Multi-storey terrace style housing (defined in Woollahra LEP 2014 as either semi-detached dwellings or attached dwellings)
- ▶ 1.3.5 Dwelling houses
- ▶ 1.3.6 Residential flat buildings, manor houses, multi dwelling housing (terraces) and multi dwelling housing
- ▶ 1.3.7 Buildings in the William Street MU1 Mixed Use Zone
- ▶ 1.3.8 Commercial and industrial buildings including shops
  - All commercial buildings
  - Commercial development in Oxford Street
- ▶ 1.3.9 Pubs
- ▶ 1.3.10 Places of public worship and educational establishments
- ▶ 1.3.11 Public buildings
- ▶ 1.3.12 Existing contemporary infill
- ▶ 1.3.13 Infill development (new development)
- ▶ 1.3.14 Intrusive buildings

---

### C1.3.1 Single storey buildings

---

Single storey buildings include timber, stone, brick and weatherboard cottages, terraces, semi-detached houses and single storey shops.

Architectural styles include Georgian, Victorian and Federation. The scale of buildings generally range from the typical small and narrow fronted buildings to medium to large houses ranging in date from 1840s to 1920s.

Single storey buildings, in particular the timber cottages, are significant because of their rarity. Many single storey buildings are also significant because of their historical association with the evolution of the early Paddington village and the artisan community that developed at the junction of Glenmore Road and New South Head Road.

Additions to these single storey buildings need to be carefully considered (see Figure 1). Refer to Figures 2 and 3 for examples of intrusive and non-intrusive extensions.

#### Objectives

- O1 To retain and conserve single storey buildings.
- O2 To conserve the settings of single storey buildings.
- O3 To ensure that the scale and form of single storey buildings are retained and that alterations and additions do not dominate the building.
- O4 To retain and enhance the distinctive shared characteristics of the rear elevations of pairs or groups.

#### General Controls

These controls apply to all alterations and additions to single storey buildings, including courtyard housing additions:

- C1 Principal building forms and original external materials are to be retained.
- C2 Retain or reinstate façade details and open verandahs where physical or documentary evidence exists demonstrating an earlier state.
- C3 Where alterations are required to meet the National Construction Code requirements, materials must be consistent with traditional materials and finishes.
- C4 Additional storeys are not permitted to the principal building form where the existing roof height will be increased, and changes to the existing roof pitch and eaves height will occur.
- C5 Roof space within the principal building form may be used where there will be no change to the existing roof height, roof pitch, eaves height or ceiling below. No change to the rear roof plane is permitted to the principal building form with the exception of a compliant dormer and skylight.

---

Note: Control C5 is included to ensure that the rear roof of the principal building is not raised to incorporate a higher extension or higher link structure to courtyard housing.

- C6 The addition of dormers or skylights in the rear roof slope of the principal building form is to comply with controls in Section 1.5.1 Dormers and skylights.
- C7 Ground floor additions and courtyard housing additions to the rear of a single storey building must not compromise the form of the principal building.
- C8 Existing setbacks from the front and side boundaries for the principal building form are to be retained.
- C9 Additions at the rear of buildings must not extend beyond the predominant rear building setbacks at any level of a group or row of buildings.
- C10 Additions of an appropriate form and scale are permitted at the rear of the principal building form if:
  - a) the addition is a ground floor rear addition attached to the principal building below the existing eave or employs a courtyard housing style addition (refer to controls below); and
  - b) for additions other than courtyard housing additions, the addition incorporates a skillion roof. Reverse skillion roofs are not permitted.
- C11 Additions to single storey semi-detached and terrace groups must not compromise the architectural character of the pair, or the group of houses.

#### *Courtyard housing additions*

Courtyard housing is not an infill development or a garage or a loft over a garage or a studio. Controls for infill development are included in C1.3.13. Controls for a loft over a garage or studio are included in C1.5.7.

- C12 A courtyard housing addition may be permitted if:
    - a) it would not have an adverse impact on the heritage significance of the existing building, adjoining properties, or the group of buildings, where the building forms part of a group;
    - b) it does not disrupt a coherent pattern of pairs or groups;
    - c) it is not visible, directly or obliquely, from any part of the street to which the property's street front zone abuts and from the front yard within the street front zone;
    - d) it will have a negligible impact on the amenity of neighbouring properties in terms of loss of sunlight, ventilation and privacy;
    - e) it will not adversely affect the setting of the existing building; and
    - f) it is subsidiary to the existing building and will not dominate the existing building in terms of bulk and scale.
  - C13 A courtyard housing addition must be single storey and must not be able to be seen over the roof of the principal building.
  - C14 A courtyard housing addition must be wholly located at the rear of the existing principal building. Additions that wrap around the principal building are not appropriate.
-



---

C15 Where a courtyard housing addition is appropriate:

- a) a narrow, non-habitable linking structure may be provided between the principal building form and the courtyard housing addition;
- c) the linking structure must be single storey, with a maximum height of 2.4m or below the eaves of the principal building form, whichever is the lower;
- d) the width of the linking structure must be a maximum of 1.5m internally;
- e) the linking structure must be a narrow, non-habitable lightweight construction to differentiate the new work from the original. Lightweight construction should comprise appropriate materials, roof form and overall design. Appropriate materials include glass, steel and timber. Very minor masonry material may be included;
- f) it must include a usable courtyard, provided that a compliant rear building alignment can be achieved and the bulk and scale of the addition does not result in adverse privacy and overshadowing impacts on adjoining properties;
- g) the inclusion of a courtyard must comply with the controls and minimum requirements in Section C1.4.8 Private open space, swimming pools, courtyards and landscaping; and
- h) the height of the courtyard housing addition must not exceed the ridge height of the principal building form (chimneys not included).

Note: see Figure 3B for reference.

C16 The roof of the courtyard housing addition must:

- a) be an appropriate response to the traditional roof form and pitch of the principal building. Skillion roofs must comprise a single roof plane. Curved roofs, flat roofs, mansard roofs, parapet roofs and reverse skillion roofs are not permitted; and
- b) match the pitch of roofs where an unchanged established pattern of rear roofs exists or, where an unchanged pattern does not exist, must be a minimum pitch of 6 degrees.

C17 Provided that C12 and C15 are satisfied, a contemporary design for the courtyard housing may be used.

C18 An attic is permitted within the roof space of the courtyard housing addition, provided that:

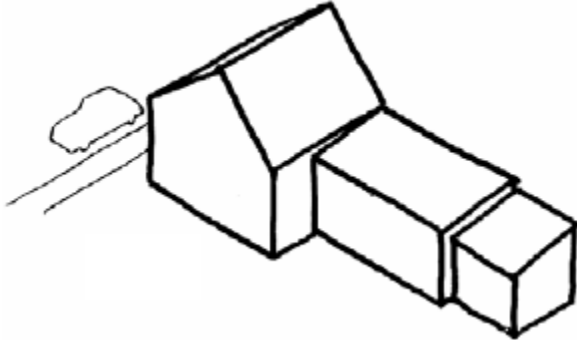
- a) satisfactory floor to ceiling height standards are achieved;
- b) the form and pitch of the courtyard housing addition roof matches the form and pitch of the roof of the principal building;
- c) only one dormer is permitted (in either the front or rear roof plane). Where the width of the addition is greater than 6m, a second dormer may be permitted in the same roof plane, provided that each dormer is identical in type, size and no greater than 1.2m maximum width overall. The top of the dormer must be set below the main ridge by at least 300mm. The inclusion of a dormer must comply with the controls in Section C1.4.10 Acoustic and visual privacy; and
- d) no more than 2 skylights (compliant with the controls for Skylights in C1.5.1 Dormers and Skylights) are located within the entire roof plane.

C19 Roofing materials must comply with C1.5.8.

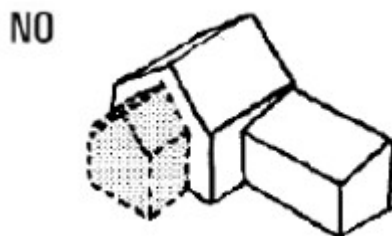
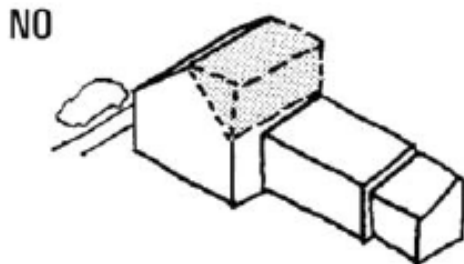
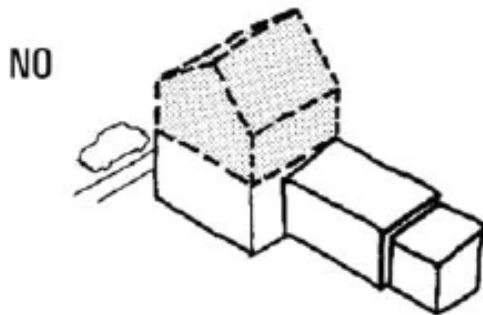
---

Refer to objectives and controls in C1.4 General controls for all development and C1.5 Specific policy for building and site elements.

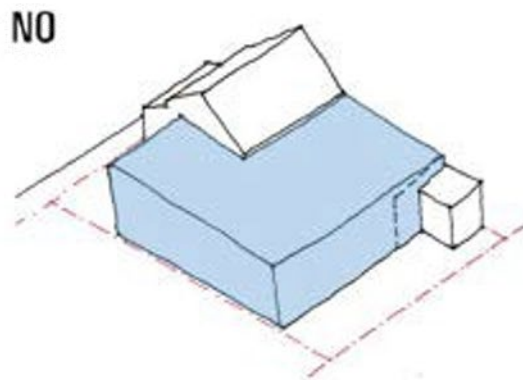
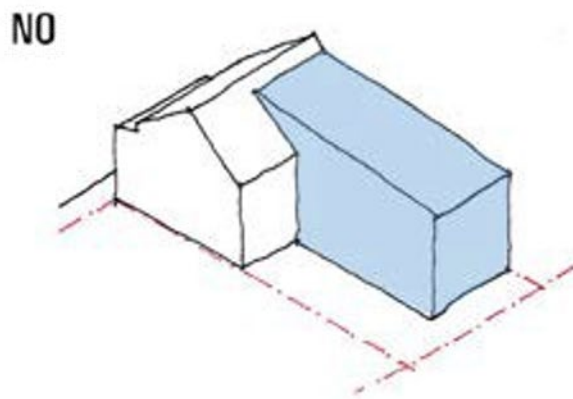
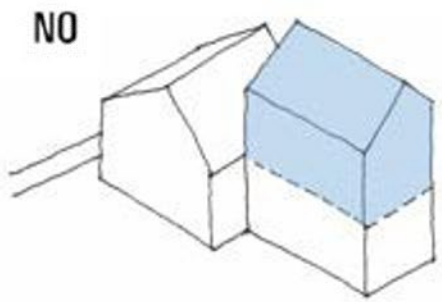
**FIGURE 1** Generic version of a single storey terrace



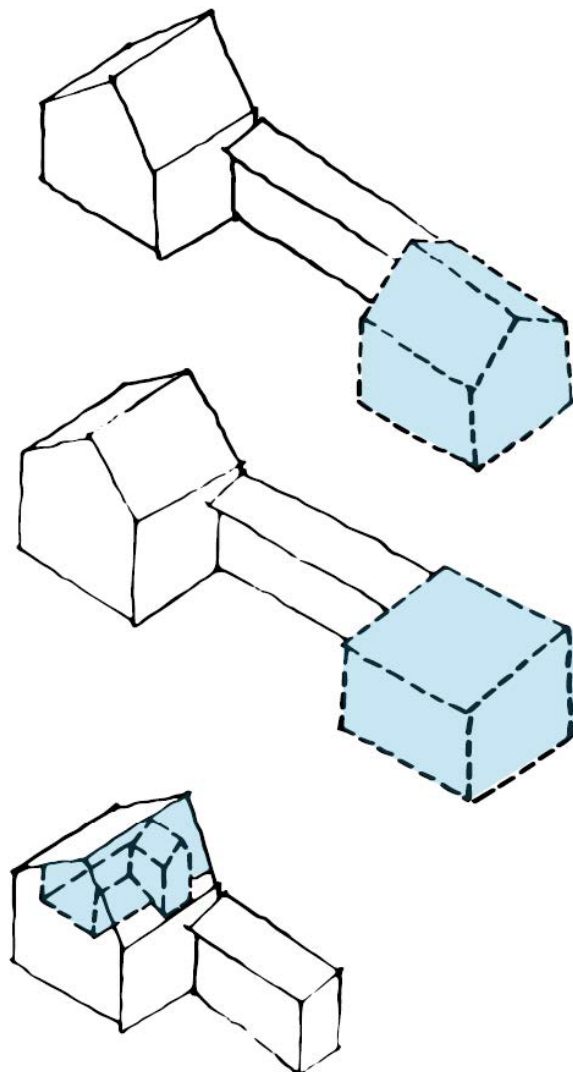
**FIGURE 2A** Intrusive additions



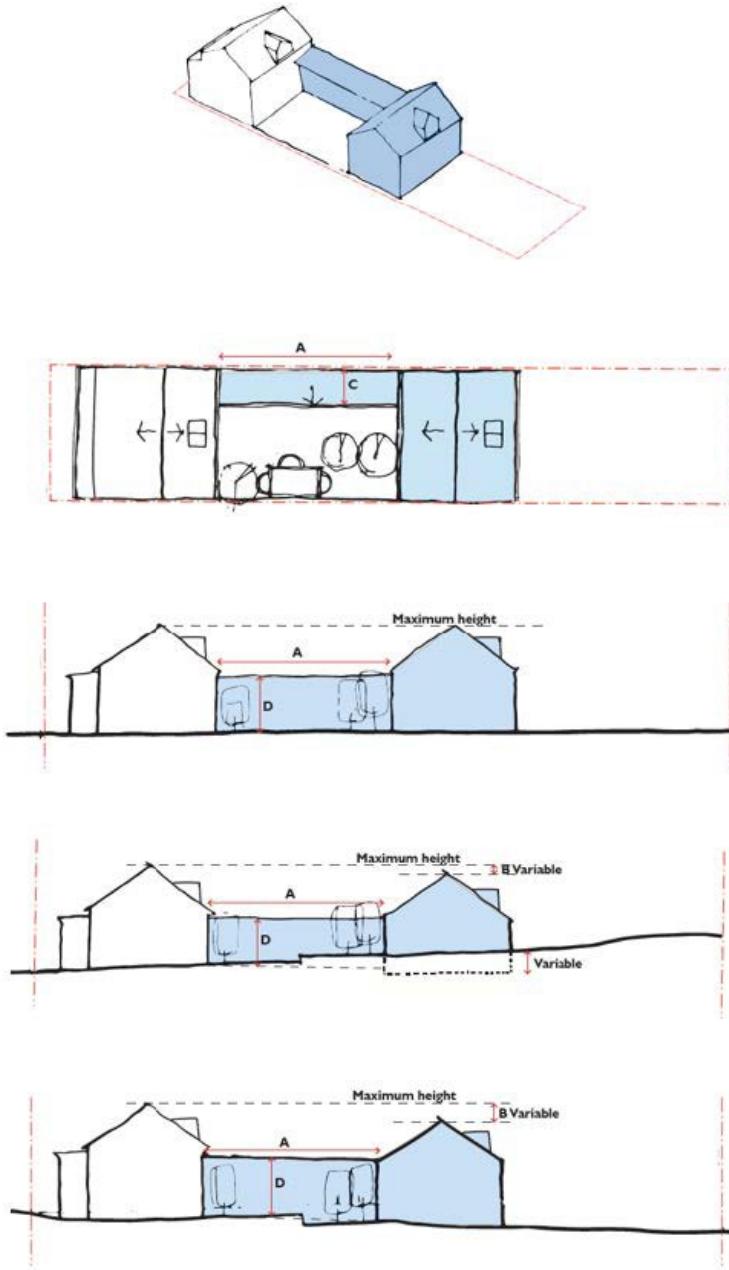
**FIGURE 2B** Intrusive additions



**FIGURE 3A** Non-intrusive development



**FIGURE 3B** Non-intrusive development. Example of a courtyard housing addition with the same pitch, form and orientation as the principal building form.



**Measurement A:** dimension must provide a usable courtyard and must comply with the controls and minimum requirements in Section C1.4.8 - Private open space, swimming pools, courtyards and landscaping - provided that a compliant rear building alignment can be achieved.

**Measurement B:** dimension must provide an addition that is single storey, may be equal to or lower than the ridge height of the principal building form (not including chimneys), and must not be able to be seen over the roof of the principal building.

**Measurement C:** dimension must be a maximum of 1.5m internally.

**Measurement D:** dimension must be a maximum of 2.4m or below the eaves of the principal building form, whichever is lower.

The diagrams in Figures 1, 2A, 2B, 3A and 3B must be read in conjunction with relevant controls which set out detailed additional requirements. The diagrams do not show examples that reflect all the relevant controls.

---

### C1.3.2 Timber buildings

---

Timber buildings within the Paddington Heritage Conservation Area include single storey Victorian workers' cottages, two storey Victorian workers' houses, Early Victorian single storey cottages, Late Victorian terraces and semi-attached timber houses.

All forms of timber buildings contribute to the diverse character of Paddington streetscapes and the aesthetic value of the conservation area. Timber buildings are also significant because of their rarity and historical association with the evolution of the Paddington Heritage Conservation Area.

The vast majority of timber buildings in Paddington are single storey workers' cottages constructed between 1840 and 1870. These buildings were built to accommodate local artisans and working class families who played an important role in the development of the Paddington village.

Timber buildings are vulnerable to change and many have been modified over time, are in a deteriorated condition or suffer from structural instability. Despite these changes timber buildings in Paddington continue to make an important contribution to the character of the conservation area and should be conserved.

#### Objectives

- 01 To retain and conserve timber buildings and their setting.
- 02 To retain, restore and conserve the special characteristics and details of timber buildings.
- 03 To restore and reconstruct missing elements of the principal building form within the street front zone.
- 04 To retain and conserve significant side and rear forms of timber buildings.
- 05 To retain, restore and promote the significance, contribution and relationship of a timber building within the context of the conservation area.
- 06 To ensure that additions and alterations for fire and access upgrading are discreet, and retain and respect the significant building and its fabric.

#### Controls

- C1 Additional storeys are not permitted to the principal building form of timber buildings.
- C2 When works are proposed to the principal building form or original significant elevations visible from the street or lane, Council strongly encourages and may require restoration or reconstruction of missing elements appropriate to the architectural style of the building or reversal of uncharacteristic elements where:
  - a) balconies or verandahs have been enclosed and details such as balustrade panels, rails, columns, friezes and fringes have been removed;
  - b) original door or window types and patterns have been removed;

- c) roof cladding is in a unsympathetic material;
- d) details are missing from chimneys; and
- e) inappropriate reconstruction of period detail and elements has occurred.

Note: Reconstruction and restoration may be guided by traditional models and physical or documentary evidence of an earlier state of the building or architectural style.

- C3 Existing setbacks from the front and side boundaries of the principal building form are to be retained.
- C4 Alterations and additions to the rear of buildings must not dominate or compete with the form, height, proportions or scale of the timber building.
- C5 Where structural stabilisation of a timber building is necessary, a sympathetic structural solution that ensures the conservation of as much original external and internal fabric as possible is required.
- C6 Where alterations to timber buildings are required to meet the provisions of the Building Code of Australia, materials must be consistent with traditional materials and finishes.
- C7 No parking is permitted under or within the principal building form of a dwelling.
- C8 Fire upgrade and access works must be done sympathetically and avoid removal of significant fabric.
- C9 Refer to relevant objectives and controls in section 1.3 - Building types, section 1.4 - General policy for existing buildings and infill development and section 1.5 - Specific policy for building and site elements.



---

### C1.3.3 Corner buildings

---

#### *Corner terrace houses*

Corner terrace housing terminates a terrace row at an intersection street or lane. The form of corner terraces makes an important contribution to views and vistas at street intersections.

Generally they are built to the street boundary, having no setback at all on the side. Frequently the side gable end walls are blank, but sometimes there are windows and balconies.

Materials include stone, brick, stucco, render, cast iron and terracotta.

#### Objectives

- 01 To retain and conserve the architectural detail and special character of corner terraces.
- 02 To ensure that traditional side elevations, forms and alignments are retained.
- 03 To ensure that side additions are of a sympathetic design and construction to the original building.

#### Controls

- C1 Refer to objectives and controls in Section C1.4 General controls for all development and Section C1.5 Specific policy for building and site elements.

#### *Corner shops and corner commercial buildings*

Corner shops and corner commercial buildings are typically one or two storeys in height and are often located at cross streets. Corner shops are usually the corner terrace of a row of terraces, but may be a corner building on their own. Often they have an angled entry elevation, as well as elevations on two street sides, all of which are built to the boundary.

Many corner shops remain as shops but others have been changed to restaurants, cafes, galleries and residences. The typical shop windows are large and face the streets on either corner with the entrance at the corner. Building materials include stone, brick, stucco, render, cast iron, terracotta and some timber.

Corner shops and commercial buildings reflect the neighbourhood evolution of Paddington and have a high social and historical significance.

Note: The controls and objectives in this section apply in addition to the objectives and controls for 'All commercial buildings'. If there are any inconsistencies, these corner controls take precedence.

### Objectives

- O1 To retain and conserve corner shops and corner commercial buildings as distinct building forms and as evidence of the evolution of Paddington.
- O2 To retain and conserve corner shops and corner commercial buildings because of the service they provide to residential neighbourhoods and because they provide a positive contribution to the pedestrian environment of Paddington.
- O3 To encourage the reinstatement of suitable retail and commercial uses within existing shops and commercial buildings in recognition of the social and historic significance of these types of uses and their role in the neighbourhood evolution of Paddington.

### Controls

- C1 Retain original shopfront windows, joinery and architectural details irrespective of a building's use.
- C2 Shopfront windows must remain as showcases and not be obscured by walls or partitions.
- C3 Refer to the objectives and controls in Section 1.3.1 Single storey buildings, Section 1.3.8 Commercial and industrial buildings including shops, Section C1.4 General controls all development and Section C1.5 Specific policy for building and site elements.

---

### C1.3.4 Multi-storey terrace style housing

---

Multi-storey terrace housing includes mostly two and three storey terraces, some containing additional basement and attic levels. This housing was traditionally built in uniform rows; occasionally containing distinct subgroups or individual buildings within groups.

The lot width and configuration is the main determinant of the terrace house size, scale and arrangement pattern, with the three storey terraces generally occurring on the larger lots.

Architectural styles and the periods of construction vary and include Georgian, Victorian and Federation.

Predominantly terraces have front verandahs and balconies built to address the street, and party walls which separate the dwellings.

Groups of terrace houses occasionally contain subgroups of varying building widths and detailing, or may be terminated by an individual end terrace (see Section 1.3.3 Corner buildings) or mixed residential/corner shops and commercial buildings (see Sections 1.3.3 and 1.3.8 ).

#### Objectives

- 01 To retain and conserve the principal building forms of rows, pairs and groups of terraces.
- 02 To retain significant rear and side forms.
- 03 To retain the rear forms of unaltered pairs and groups of terraces.
- 04 To retain the shared distinctive characteristics of pairs and groups of buildings.
- 05 To retain, restore and promote the significance, contribution and relationship of a building within the context of a pair or a group of buildings.

#### Controls

##### All multi storey terrace style development

- C1 Refer to objectives and controls in Section C1.4 General controls for all development and Section C1.5 Specific policy for building and site elements.

---

### C1.3.5 Dwelling houses

---

There is a range of freestanding dwelling houses in the Paddington HCA, including Victorian manor houses, timber cottages and freestanding buildings with terrace style form.

However, freestanding dwelling houses in the context of the Paddington HCA are generally constructed in a terrace style form, and though they tend to abut adjoining buildings they do not share a common party wall with the adjoining dwelling. To that end, these dwelling houses are freestanding, and are distinguished from semi-detached dwellings and attached dwellings as defined in Woollahra LEP 2014.

The dwelling houses include small timber, brick and stone cottages to larger stone and brick mansions. These range from workers' cottages, middle class housing and mansions built on original gentry estates. Examples include single storey buildings, two storey or multi-storey buildings.

A garden setting is often associated with freestanding houses. Within the curtilage there may be associated culturally significant outbuildings.

Refer also to Section 1.3.1 Single storey buildings for additions to single storey cottages.

#### Objectives

- O1 To retain and conserve dwelling houses, their curtilage and settings.
- O2 To ensure that additions to multi-storey dwelling houses do not compromise or dominate the original main front section of the house, and are suited to the architectural style of the building.

#### Controls

- C1 Refer to objectives and controls in Section C1.4 General controls for all development and Section C1.5 Specific policy for building and site elements.

---

### C1.3.6 Residential flat buildings, manor houses, multi dwelling housing and multi dwelling housing (terraces)

---

Residential flat buildings and multi dwelling housing in Paddington generally consist of small two, three and four storey buildings dating from the 1930s to 1950s, taller buildings dating from the 1960s to 1970s, and the infill buildings of the 1990s. This includes some public housing built during the 1950s.

Early building materials include brick and terracotta with the later buildings constructed from masonry, concrete and glass.

Some of these buildings, because of their scale, bulk and materials, are intrusive elements in the general context of Paddington, and therefore are not contributory buildings.

Inter-War flat buildings illustrate the Inter-War development of Paddington. They make an important historic, aesthetic, social and representative contribution to the character of Paddington, demonstrating the key characteristics of architectural styles of the Inter-War period.

#### *General*

#### Objectives

- 01 To mitigate the effects of intrusive residential flat building, manor house, multi dwelling housing (terraces) and multi dwelling housing development.
- 02 To encourage redevelopment or modification of intrusive development.
- 03 To ensure that parking does not detract from the character of the streetscape.

#### Controls

- C1 Redevelopment or modification of intrusive development must be to a design that is appropriate to the relevant aspects of the historic context.
- C2 Alterations and additions that reverse unsympathetic works are encouraged.
- C3 Alterations and additions to intrusive development must be an appropriate response to the historic streetscape and mitigate intrusiveness.

#### *Inter-War flat buildings*

#### Objectives

- 01 To conserve and maintain Inter-War flat buildings and multi dwelling housing in Paddington by ensuring these buildings and their significant characteristics are retained and protected.
  - 02 To conserve the principal street elevations and the character of Inter-War flat buildings.
-

- 03 To ensure that the character of original roofscapes, including key elements such as chimneys, is maintained.
- 04 To ensure that alterations and additions to the roofs are discreet and do not detract from the original character, proportions or key elements.
- 05 To conserve the established garden settings, including significant elements and features.
- 06 To ensure that external materials, details and finishes respect and complement the original building.
- 07 To ensure that works to balconies and verandahs do not detract from the character and form of Inter-War flat buildings.
- 08 To ensure that fences, gates and mailboxes are consistent with the character of Inter-War flat buildings.
- 09 To ensure that internal additions, alterations and repairs retain and respect internal common areas and significant internal character elements.
- 010 To ensure that the installation and maintenance of security devices does not detract from the character and form of Inter-War flat buildings.
- 011 To ensure that additions and alterations for fire upgrading and safety are discreet, and retain and respect the original and significant building fabric.
- 012 To ensure that ancillary development does not detract from the style and character of Inter-War flat buildings and their settings.
- 013 To promote restoration and reconstruction works to restore significance.

### Controls

- C1 Significant and/or original forms, details, fabrics, materials or finishes of the principal building elevations are to be retained, except for restoration or reconstruction.
- C2 Changes to the significant forms, details, materials or finishes of the principal building elevations are sympathetic to the style and period of the building.
- C3 Alterations and additions do not impact on the overall form and character of the building, and are not visually prominent from the public domain.
- C4 Additions are limited to undercroft areas, roof spaces and the provision of balconies.
- C5 Alterations and additions are no higher than the existing roof level, and generally retain the original roof form of the building.
- C6 External windows and doors are repaired or replaced to match the style, materials and finishes of the original building.
- C7 Existing original fanlights and other openings are retained and sealed from behind, if necessary.

- 
- C8 Original leadlight, glass blocks, etched and patterned glazing are retained and conserved.
- C9 Existing original external and internal doors and door hardware are retained and upgraded rather than replaced.
- C10 New additional security elements are in character with the building. Security bars are:
- a) fitted internally;
  - b) respect the existing glazing patterns; and
  - c) painted in a dark recessive colour.
- C11 Original verandahs and balconies to the principal elevation of the building are not enclosed, glazed, or otherwise altered, except to reinstate original detailing.
- C12 New verandahs and balconies are allowed to the rear or side elevations only if they:
- a) respect the character of the existing building; and
  - b) are sympathetically integrated with the character and form of the building.
- C13 Alterations to improve accessibility (including lifts, ramps and stairs) are sympathetically integrated with the original building and retain the original character and design of the building and landscape areas.
- C14 Materials are similar in type and finish to those on the original building or sympathetically integrate with the fabric of the building.
- C15 Original face brickwork, terracotta or decorative concrete panels must not be painted, rendered or coated.
- C16 Dormer windows or skylights are not visually prominent from the public domain or the principal elevations of the building. Skylights are flush with the roof surface.
- C17 Original chimneys and their details are retained.
- C18 Privacy screens are discreet and do not impact on the overall character of the building.
- C19 Protruding shade structures, including awnings and canopies, are not located on the principal building elevations.
- C20 The roof maintains traditional roofing materials of the area, such as glazed terracotta tiles. Any replacement or repair matches the original roofing in type, profile, colour and materials. Concrete roofing tiles and corrugated metal roofing are not appropriate.
- C21 Internal common areas and significant character elements are retained. This includes: entry doors, foyer areas and fittings, mailboxes, noticeboards, staircases, balustrades, wall details, light fittings, internal doors and the like.
- C22 New lifts are designed and located so that the addition:
- a) is located outside the principal building form, if practical; and
  - b) does not require significant alterations to existing common areas.
-

- 
- C23 Unsympathetic additions and modifications to the building, and its grounds, are to be removed and replaced with sympathetic works, or reinstatement of original forms and matching fabric.
  - C24 Services upgrading and fire safety works must minimise adverse visual impact and damage to original building fabric.
  - C25 Alarm bell boxes and the like, are not attached to the principal building elevations.
  - C26 New or upgraded services are discreetly and sensitively located to minimise visual impact. They are located within existing ducts, behind cornices or bulkheads or within external lightwells that are not visually prominent. Wiring or other services are housed in concealed conduits.
  - C27 Original timber staircases are retained and smoke isolated, if necessary.
  - C28 Where the height of the original stair balustrades is to be modified –the modification is discreet and sympathetically integrated with the existing stair balustrade.
  - C29 Stair treads applied to existing stairs are discreet.
  - C30 Emergency and exit lighting is incorporated into existing original light fittings, where practical.
  - C31 Smoke and/or thermal detectors are discreetly located and do not impact on decorative plaster cornices and ceilings.
  - C32 Car parking and garage structures are located at the rear, with access from the rear lane or side driveway.
  - C33 Original fencing, gates and mailboxes are retained and conserved.
  - C34 New ancillary development:
    - a) is smaller in scale than the principal building;
    - b) is not located between the principal building and the street front, and generally located at the rear behind the principal building;
    - c) is constructed in a style, form, materials and finishes that complement the principal building;
    - d) is single storey with a maximum clear internal height of 2.4m; and
    - e) is sympathetic in scale and style to traditional forms of ancillary structures.
  - C35 Characteristic front gardens, and their elements, are retained with minimal alteration.
  - C36 Structures erected in the front garden do not significantly reduce or compromise the landscaped area or key elements and features.
  - C37 New fences and gates to the front building alignment must complement the streetscape and the existing building.
  - C38 Mailboxes are discreetly located and do not impact on the character of the building.
-



Note: Refer also to Section 1.2.5 Contemporary design in Paddington and Section 1.3.14 Intrusive buildings.

### C1.3.7 Buildings in the William Street MU1 Mixed Use Zone

---

The controls in this section apply to land in William Street zoned MU1 Mixed Use under Woollahra LEP 2014. The building types in this MU1 Zone include:

- ▶ residential buildings
- ▶ purpose built commercial buildings;
- ▶ residential buildings which have been lawfully altered for a non-residential use; and
- ▶ residential buildings that retain their residential external appearance and are used for a commercial purposes.

William Street contains a mix of residential terrace buildings as well as shopfronts with residences above; these unite the busy retail promenade of Oxford Street with the dense residential terrace housing of Paddington. Since the 1980s William Street has grown to become a popular location for small fashion specialty shops, and shops with a boutique or artisan character.

It is important that the built form in William Street retains its mix of residential and non-residential building facades. In particular, development of a residential terrace for a commercial use must be undertaken in a sensitive manner to ensure that the overall character of the original building is retained, and that particular elements of the terrace house are sympathetically addressed.

The use of the terrace houses in William Street must ensure that development does not involve the demolition of common walls. This requirement is sought to retain the small scale and low key nature of dwellings and shops within the terraces by preventing amalgamation of buildings.

The ground floor non-residential uses should contribute to, and reinforce, William Street's boutique retailing character. Development should retain and enhance the heritage character of the street, with particular regard to the use of sympathetic external colour schemes and signage.

#### Objectives

- 01 To ensure that work to any building in William Street is consistent with the original character of the building type and its architectural style, and makes a positive contribution to the streetscape.
- 02 To ensure that a premises originally designed and built for a residential purpose retains a distinctive residential character.
- 03 To provide a varied streetscape by retaining a mix of residential and commercial external facades.
- 04 To ensure that development retains and enhances the heritage character of the street.
- 05 To minimise the impact of non-residential uses on the heritage significance of the street.

- 
- 06 To ensure that ground floor commercial uses contribute to William Street’s boutique retailing character.
  - 07 To ensure that security devices do not detract from traditional architectural elements, and the amenity and visual presentation of the streetscape.

### Controls

- C1 The use of a residential building for a commercial use is to retain the traditional residential appearance at the street frontage.
- C2 Development must not involve the removal of internal party walls, external common walls or dividing fences between attached terrace buildings, whether or not those buildings are on separate lots.
- C3 Development is to respect the existing traditional façade of the building and not detract from its heritage character through inappropriate materials, finishes, external colours and character elements and the like.
- C4 Traditional architectural elements, including sash windows, inward opening timber panelled front doors, balcony doors, balustrades and palisade fences are to be retained.
- C5 The following works to the street front elevation are not supported:
  - a) replacement of timber double hung sash windows with other window types, such as single sheet glass windows or windows with false glazing bars and the like;
  - i) widening of window and door openings;
  - j) replacement of multiple window openings with a single window opening; and
  - k) replacement of original front doors.
- C6 Fully glazed shopfronts are not permitted on residential buildings.
- C7 Display of goods and all business operations are confined to the building. (Note, in the case of residential terraces, verandahs and balconies are deemed to be external to the building.)
- C8 An outward opening security door in front of a traditionally panelled front door may be permitted if the design complies with Section 1.5.3 Windows, doors, shutters and security.
- C9 Signage is to be integrated with the building and is not to intrude upon the Victorian character of the area. Traditional colours for signwriting include: light brown, rich brown, Indian red, and chrome green. Overly bright colours will not be permitted.
- C10 Individual business branding and identity in external painting and colour schemes is to be subordinate to the main colour schemes in the street.
- C11 In a residential building, signs for shops or other commercial uses are limited to a maximum of two signs per building, being:
  - a) one single sign with a maximum dimension of 500mm high by 450mm wide mounted or painted adjacent to the front door; or
  - b) one single flush mounted wall sign or painted sign within the ground floor verandah blind arch; or
  - c) one projecting wall sign that:

- 
- i) has a maximum area of 300mm x 300mm;
  - ii) does not project more than 500mm from the building façade;
  - iii) does not impact on the decorative stucco of the party wall; and
  - iv) is no lower than 2.6m off the pavement, and no higher than the partywall corbelling.

### C1.3.8 Commercial and industrial buildings including shops

---

Retail and commercial buildings have always been a major feature of Paddington.

For example, Oxford Street is a homogenous Victorian commercial precinct established since the 1860s and is the main shopping area of Paddington. A smaller group of retailers is located at Five Ways, which was established by 1910. More recently, William Street, as an extension of Oxford Street, has emerged as a boutique retailing street adapted from residential terraces.

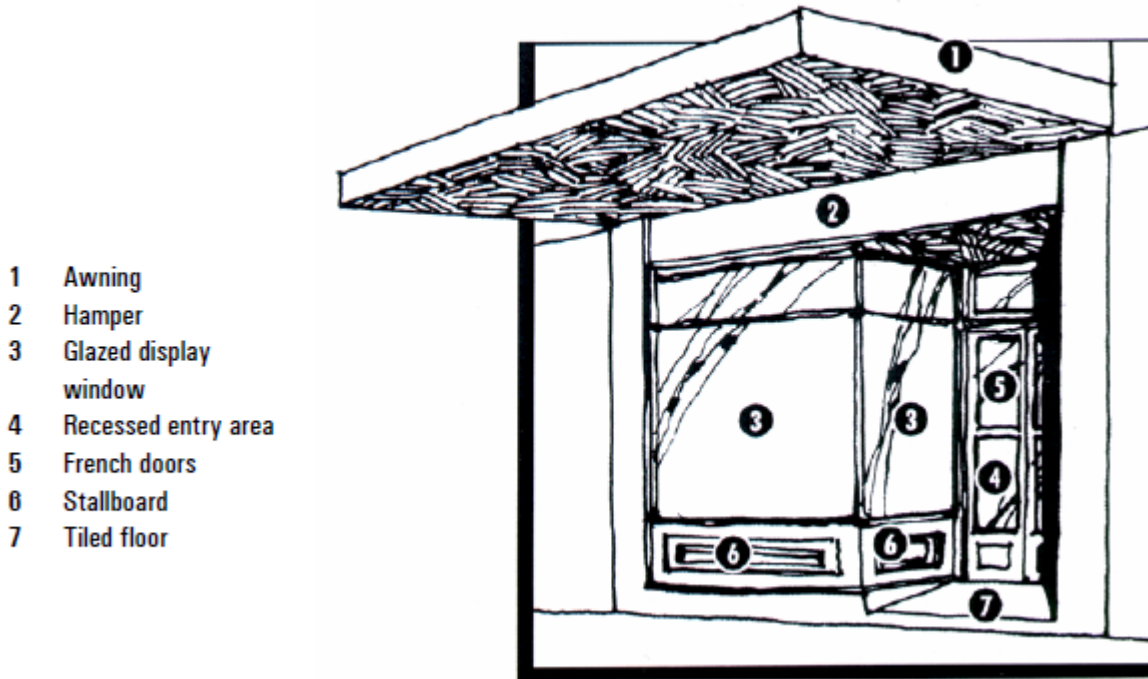
Other shops are scattered throughout Paddington, mostly on street corners. These shops have survived; many with changed uses and most have a high degree of integrity.

In Oxford Street the general cohesiveness of the streetscape comes from the original above-awning elevations. Decorative parapets are common. Architectural styles include Victorian, Federation and Inter-War and date from the early 1860s to the 1940s. Building materials include stone, brick, stucco, render and timber.

Shops are typically one or two storey in height and include single storey and two storey residential terraces with shopfronts. Shopfronts are stylistically diverse. They include original Victorian shopfronts, and Federation, Inter-War and Post War shopfronts.

Commercial and industrial buildings are also spread throughout the area, with mixed architectural forms and varying degrees of integrity. Industrial buildings include garages, workshops, service stations and light industry factories. These buildings include large single storey buildings constructed from brick and corrugated iron.

**FIGURE 4** Traditional shop front



*All commercial buildings*

**Objectives**

- O1 To retain and conserve forms, significant elevations, details and finishes of commercial, industrial and retail buildings.
- O2 To retain and conserve good representative examples of significant architectural styles in the historic development of commercial retail and industrial buildings in Paddington.
- O3 To retain and conserve original shopfronts.
- O4 To ensure that security devices do not detract from the traditional architectural elements and the amenity and visual presentation of the streetscape.

**Controls**

*General*

- C1 Principal building forms are to be retained.
- C2 Significant architectural elevations and significant finishes and details are to be retained.
- C3 Works for the adaptive re-use of a building must be consistent with the overall character of the building type, its architectural style and its context within the HCA.

- 
- C4 Refer to the objectives and controls in Section 1.2.3 Character elements, Section 1.3.1 Single storey buildings, Section 1.3.3 Corner buildings and Section C1.5 Specific policy for building and site elements.

#### *Shopfront elevation*

- C5 Shopfronts that are examples of significant architectural styles in the historical development of Paddington are to be retained.
- C6 New work to significant shopfronts is to be consistent with the style and character of the building and the streetscape.
- C7 Original windows above the awning are to be retained and not altered in size.
- C8 Shopfronts must not be amalgamated. Where internal spaces of buildings are amalgamated, individual shopfront elements and features such as shop windows and doors must be retained.
- C9 For new buildings and existing buildings where no significant fabric or layout is present in the shopfront, contemporary design is permitted if it is consistent with the building's historic streetscape context in terms of:
- a) materials, colours and finishes;
  - b) proportions of windows and doorways, including the division of windows with their bases and vertical sections;
  - c) detailing; and
  - d) signage.
- C10 Reconstruction of original shopfronts may be permitted where a shopfront forms part of a group or where sufficient evidence exists showing the original shopfront design.
- C11 Removal of original shopfronts or elements of an original shopfront is not permitted except for the purposes of restoration.
- C12 When work is proposed to an intrusive shopfront, reconstruction, restoration or contemporary interpretation according to C6 is required.
- C13 Where awnings are a characteristic element in the streetscape, the awnings must complement the existing streetscape character.

#### *Additional controls for the Five Ways*

- C14 For land zoned E1 Neighbourhood Centre in the Five Ways, regardless of the building type, the replacement of timber double hung sash windows with a single street glass window to the street front elevation may be permitted if consistent with the streetscape context and the characteristics of related buildings.

---

## ***Commercial development in Oxford Street***

### **Character statement**

Oxford Street, Paddington, is positioned on the ridge running from the City of Sydney to Bondi Junction. A traditional main street has developed along the north side of Oxford Street for almost 1.5km from Boundary Street in the west, to Queen Street in the east.

The centre is a predominantly Victorian and Edwardian (Federation) commercial precinct established since the 1860s and is the main shopping area for Paddington. Oxford Street has attracted fashion shops in the last two decades and has transformed from a strip serving the local population to a destination shopping location.

The north side of Oxford Street is characterised by continuous development with a very consistent architectural scale and character. The built form in Oxford Street consists of shopfronts with a cohesive streetscape established by the original above awning elevations. Decorative parapets are common. Architectural styles are predominantly Victorian and Edwardian buildings with some later Inter-War buildings. Building materials include stone, brick, stucco and timber.

The south side of the road is in the City of Sydney local government area. It contains a number of institutional and civic buildings, interspersed by small groups of commercial buildings. A popular Saturday market also operates on the south side of Oxford Street within the Paddington Public School and the Uniting Church.

Increasing traffic on Oxford Street has impacted on the pedestrian environment, which compromises the interrelationship between the north and south sides of Oxford Street.

### **Desired future character**

The character of Oxford Street is defined by its heritage items and contributory buildings generally in the form of two storey buildings with parapet façades establishing a consistent street wall. There are also some distinctive and contributory buildings interspersed amongst the regular shops, including the Post Office building, Juniper Hall and the Imperial Hotel.

The street is part of the Paddington Heritage Conservation Area, and the desired future character is to retain the existing built form and established urban character. Development will primarily involve the adaptive re-use of existing buildings and rear additions.

To ensure the conservation and enhancement of heritage items and contributory buildings, development is to respect the design of neighbouring buildings and the conservation area generally in regard to significant fabric and façade characteristics, scale, massing, materials, details, orientation and setbacks.

The retail vitality of Oxford Street needs to be reinforced. Oxford Street is a destination precinct, attracting shoppers to its boutiques and designer fashion shops from outside the local area. There is a need to continue to encourage fashion retail uses, supported by cafes and restaurants and other active ground floor uses, and to re-establish the strip's role in serving the local community. The development of residential uses may occur as part of mixed use buildings on upper levels.

## Objectives

- 01 To reinforce and build on the precinct's reputation as a boutique shopping main street.
- 02 To provide for a mix of active ground floor uses that contribute to the vitality and viability of the centre.
- 03 To retain and restore the original shopfront windows, joinery and architectural details.
- 04 To maintain the consistent street wall and frontage height of Oxford Street.
- 05 To ensure that building materials, details, colours, materials and finishes are sympathetic to the conservation values of the street.
- 06 To ensure that roof and parapet forms contribute to the established character of Oxford Street.
- 07 To ensure that side elevations, particularly those that are visually prominent, do not detract from the visual character of the street.
- 08 To ensure that corner buildings are designed to provide important elements in the physical pattern of the street and contribute to the perception of distinct blocks and groups of buildings.
- 09 To ensure that awnings provide a consistent element within the streetscape.
- 010 To provide shade and wet weather protection for pedestrians.
- 011 To encourage opportunities for rear development on deep and narrow sites, particularly those sites with rear lane access.
- 012 To provide a sympathetic transition in built form and uses between the residential areas and the Oxford Street commercial strip.
- 013 Infill development is to respect the design of neighbouring buildings and the character of the conservation area in regards to scale, massing, materials, details, orientation and setbacks.
- 014 To ensure that advertising signs and structures respect the heritage and architectural character of individual buildings and the street as a whole.

---

## Controls

- C1 The ground floor must contain active uses that add to the pedestrian experience on the street:
    - a) retail uses including fashion boutiques and cafes; and
    - b) non-retail uses, such as entertainment facilities, must provide strong visual connection with the street and retain and conserve the traditional shopfronts established by the predominant retail frontages.
  - C2 The adaptive re-use of a building must be consistent with the overall character of the building type, its architectural style and its context within the heritage conservation area.
  - C3 Uses must protect existing shopfronts and street elevations and must not compromise the established pattern and rhythm of frontages and the heritage character of the street.
  - C4 The height of development must conform to the predominant heights of adjacent buildings and the prevailing wall height in the streetscape.
  - C5 Development must respect the relationship of building heights to view corridors and the skyline.
  - C6 New balconies are not encouraged on the Oxford Street frontage other than to reinstate an original awning/balcony and support columns.
  - C7 Alterations and additions to heritage items and contributory buildings must retain original shopfronts. Fully glazed shopfronts are not permitted.
  - C8 Sympathetic use of contemporary design and materials may be considered.
  - C9 Uncharacteristic elements or structures should be removed, and missing elements reinstated.
  - C10 The range of colours, materials and finishes of new building work should complement existing heritage and contributory buildings, particularly above the awning line.
  - C11 Colour schemes are to be appropriate to the individual building and the street as a whole. Extreme colour schemes diminish unity and detract from the streetscape, particularly if above the awning line.
  - C12 Colour schemes to the under awning façade may have greater variety and visual interest, but should not detract from the established streetscape character.
  - C13 Parapet height and rhythm is to be consistent. Parapets should predominantly be masonry.
  - C14 Infill development should include parapets and roof forms that respect the existing conditions in terms of parapet height, pitch and shape of roofs.
  - C15 Architectural elements of side elevations are to be retained, restored or reconstructed.
  - C16 Corner sites are to be designed to maintain visual prominence in the street wall of Oxford Street. This is generally achieved through architectural elements such as parapet walls.
  - C17 New corner buildings are to address both street frontages.
-



- C18 Awnings are reinstated in the original location, where evidence of the original structure exists.
- C19 Rear extensions should be designed to:
- a) improve casual surveillance and vibrancy of rear lanes;
  - b) minimise impact to significant landscape elements; and
  - c) protect the privacy and amenity of adjoining or adjacent residential uses.
- C20 New buildings must maintain and reflect:
- a) the established patterns and proportions of existing elevations which consist of a horizontal orientation below the awning line and a more vertical character above the awning line;
  - b) the consistency of horizontal and vertical façade features such as window heights and widths, bay widths, awning and parapet lines;
  - c) the established rhythm and pattern in the street arising from the original subdivision pattern; and
  - d) existing setbacks (generally zero setbacks) to front and side boundaries.
- C21 Above awning advertising signs are not permitted.
- C22 Signs and advertising must comply with the controls for advertising signs on buildings in Part E of this DCP, Chapter E7 Signage.

---

### C1.3.9 Pubs

---

Pub buildings are located throughout Paddington and have important historical, aesthetic and social significance that contribute to Paddington's character. Most pubs in Paddington are substantial buildings ranging in height from two to four storeys. They date from the 1840s through to the 1940s and are prominent place markers, often located on corner sites.

The pubs have an imposing presence with distinctive parapet profiles, modulated façades, window and door openings and ornate architectural detailing. Building materials include stone, brick, stucco, timber, glazed tiles and terracotta. The pubs display a diverse range of architectural styles including Victorian, Federation and Inter-War buildings.

Some buildings exhibit original elevation detail and a few retain their original interior detail.

Pubs owe their survival to their ability to offer the latest in comfort, service and amenities, consistent with the demands of their customers. To meet these situations and to also comply with legislative requirements relating to matters such as trading hours and public amenity, alterations and additions to pubs occur from time to time. Despite the fact that pubs are prone to physical change, a number of Paddington pubs remain close to their original configuration, appearance and use.

Some pubs may have been converted to other uses, including (but not limited to) residential, office premises or community centres. However, their exterior form retains its distinctive pub appearance which contributes to Paddington's character.

This section of the DCP applies to all buildings that are currently or were formerly a pub.

Note: A Pre-DA meeting is recommended for major changes to pubs or former pub buildings in Paddington. Council may require the submission of a Conservation Management Plan, subject to the extent of changes.

#### Objectives

- 01 To ensure that the external integrity, scale, character and relationship of a pub building with the surrounding streetscapes remain unaltered.
- 02 To ensure alterations and additions are sympathetic and respect the heritage significance of pub buildings.
- 03 To protect interiors that contribute to the heritage significance of a pub or that date from significant phases of development.
- 04 To retain original names of pubs as part of the historical and social significance of Paddington.
- 05 To retain residential accommodation within pubs.
- 06 To support the continued role and presence of pub buildings in Paddington even in the event of an adaptive re-use.
- 07 To remove uncharacteristic elements or structures.

- O8 To retain original roof forms and appearances of pub buildings in Paddington.
- O9 To protect and retain moveable heritage.
- O10 To ensure that advertising signs and awning structures respect the heritage and architectural character of pub buildings.

## Controls

### *Internal*

- C1 Significant interior features are to be retained.
- C2 Missing significant internal elements, details and finishes should be restored or reconstructed. These include:
  - a) decorative ceilings;
  - b) significant materials and finishes including (but not limited to) tiles, timber panelling and wall papers;
  - c) joinery, including stairways;
  - d) fittings, including light fittings; and
  - e) traditional signs and advertising.
- C3 Original room configurations must remain discernible. Where new openings are proposed, interpretation of original wall positions and room proportions should be provided, such as portal frames, nibs or bulkheads.
- C4 Moveable heritage and other significant heritage artefacts must be retained in their context.
- C5 Fire upgrade measures must be done sympathetically and avoid removal of significant fabric.

### *External*

- C6 Original elevations must be retained and conserved.
  - C7 Face brick and tiles are not to be painted over, rendered or retiled.
  - C8 Significant external features are to be retained and maintained. Where appropriate, missing elements, details and finishes should be restored or reconstructed. These include:
    - a) pressed metal ceilings to awnings;
    - b) awnings and balconies;
    - c) traditional signage;
    - d) typical features of an architectural style;
    - e) significant doors and openings; and
    - f) significant materials and finishes (including but not limited to wall tiles).
-

- C9 The restoration of missing detail or reversal of unsympathetic work to street front elevations is required when work is undertaken to the principal elevations.
- C10 The original name of a pub must be retained and displayed appropriately in signage.
- C11 Traditional hotel signage and product advertising, such as painted glass panels advertising beer brands, wall signs and awning signs should be retained, protected and displayed.
- C12 When awnings are to be reinstated, they are to be reinstated in the original location and must complement the existing streetscape character.
- C13 The prominence and form of parapets and roof lines must be retained. Additional levels are not to be visible from the public domain.
- C14 The original massing and scale, pattern and modulation of façades and the proportions of openings must be retained.
- C15 Mechanical plant equipment (including communications, electrical, air-conditioning and kitchen exhaust systems) must not adversely impact the roof form or be visible from the public domain.
- C16 Alterations and additions must be consistent with heritage management documents.
- C17 Reconstruction and repair works are to use traditional materials and techniques in accordance with best heritage practice and a heritage management document.

---

### C1.3.10 Places of public worship and educational establishments

---

Since the 1840s Paddington has always had a strong church and school presence but over time many church and school buildings have been demolished and have been replaced with other types of buildings.

The remaining churches include St George Anglican Church built in 1888 and The Church of Christ built in 1901. Both are masonry with the latter being a much smaller building.

Schools in Paddington include Glenmore Road Public School built of stone and brick in 1884, and Edgecliff Preparatory School built of masonry.

#### Objective

- O1 To ensure that any new work is carried out with due regard to the significance of the building and its setting.

#### Controls

- C1 Refer to objectives and controls in Section 1.2.3 Character elements, Section C1.4 General controls for all development and Section C1.5 Specific policy for building and site elements.
- C2 Work undertaken on heritage items must comply with the management policies in a conservation management plan, where such a plan is required by Council.
- C3 For schools, refer also to objectives and controls in Part F of this DCP, Chapter F2 Educational Establishments.

---

### C1.3.11 Public buildings

---

Remaining public buildings in Paddington include the post office and the police station (former courthouse).

The post office is a two storey stuccoed masonry building in the Victorian Free Classical style. Built in 1885, its features include a parapet tower on the western end and a colonnaded loggia between the tower on the west and the curved corner pier on the east.

The former court house building was designed in the Victorian Italianate style and built in the 1880s. Situated between terrace houses it has a recessed portico with a central entrance. Main materials are stuccoed brickwork.

#### Objectives

- O1 To ensure that any new work is carried out with regard to the significance of the building.
- O2 To encourage the ongoing use of public buildings.

#### Controls

- C1 Refer to objectives and controls in Section 1.2.3 Character elements, Section C1.4 General controls for all development and Section C1.5 Specific policy for building and site elements.
- C2 Work undertaken on heritage items must comply with the management policies in a conservation management plan, where such as plan is required by Council.

---

### C1.3.12 Existing contemporary infill

---

Existing contemporary infill refers to buildings (generally 1970 to the present) that occur between terrace style housing. Materials often include rendered brickwork, concrete and glass and architectural styles referred to as modern, 'Sydney School', contemporary or post-modern.

#### Objectives

- O1 To ensure that any new work has regard to the building's context.
- O2 To ensure that any new work does not detract from the architectural merit the building may possess.

#### Controls

- C1 Refer to relevant objectives and controls in Section 1.2.3 Character elements, Section C1.4 General controls for all development, Section 1.1.13 Infill development (new development) and Section C1.5 Specific policy for building and site elements.
- C2 Where the building is not intrusive, additions are to be consistent with the character of the existing building and the massing of existing development within the streetscape.

### C1.3.13 Infill development (new development)

The term ‘infill development’ is defined as the erection of a building that is:

- constructed on an existing vacant registered allotment of land; and
- does not include side, rear or front alterations and additions to an existing building.

Note:

Demolition is generally not supported. All proposals for demolition of a building must be approved via a thorough planning process that includes an assessment of the contribution the building is making to the Paddington Heritage Conservation Area, a fabric analysis and an assessment of the impact that the loss of the building may have on the significance of the heritage conservation area.

Infill development provides the chance for the continuing enrichment of Paddington by adding new built form which is an expression of contemporary life.

Opportunities for infill buildings may occur where existing buildings have been demolished or where vacant allotments exist or have been created. Demolition and subdivision will require assessment through the development application process.

As the opportunities for infill development are rare, designs for such sites are required to demonstrate an appropriate response to context and an approach which enhances the character of Paddington and its cultural significance.

Infill development should not be a ‘faux’ representation of a historical architectural style. Rather, Council requires a contemporary design approach which respects:

- the historic context;
- siting; and
- architectural forms (including roof form, roof pitch, height, scale, massing, alignment, modulation, articulation and materials);

and achieves a cohesive relationship between the existing and new urban fabric.

Note:

A Pre-DA Meeting is recommended between Council representatives and the applicant for infill development proposals.

The following information is to be submitted for comment for discussion at the Pre-DA Meeting:

- a draft site and context analysis;
- design options explored and the applicant’s preferred infill design proposal;
- a statement outlining the proposed measures to minimise the adverse impact of the infill development on neighbouring lands, including the public domain;
- the philosophy of how the design elements relate to the proposal’s context in terms of architectural form, materials and character; and
- the historic context and impact sections of a draft statement of heritage impact.



---

For development applications, applicants are required to provide the following information, not limited to:

- ▶ design options and final preferred design;
- ▶ a detailed site and context analysis;
- ▶ profiles of adjoining development;
- ▶ RLs for the subject site and adjoining properties;
- ▶ an accurate survey for the subject site (including levels of adjoining buildings and their architectural elements);
- ▶ a schedule of materials, finishes and colours. Where contemporary materials are proposed, a statement must be provided that outlines how the contemporary materials are in keeping with the character elements and desired future character of the heritage conservation area, particularly in terms of solid-to-void ratios, detailing and proportions, textures and finishes;
- ▶ the structural relationship with adjoining properties (including shared party walls, footings and chimneys); and
- ▶ the final version of the statement of heritage impact.

Other required documentation to be submitted with the development application can be found in the Development Application Guide.

### Objectives

- 01 To encourage development on infill sites which reflects contemporary values and employs contemporary design, and through a design idiom, materials and construction technique provides an appropriate response to relevant aspects of the historical context of Paddington.
- 02 To ensure new development on infill sites is designed and located to achieve a cohesive relationship between new and existing urban fabric, and which retains and enhances the cultural significance of the heritage conservation area.
- 03 To ensure infill development respects the scale and setting of adjacent contributory buildings.
- 04 To protect the amenity of adjoining or adjacent residential uses.
- 05 To ensure that infill development does not prevent the maintenance and conservation of elements that contribute to the significance of the heritage conservation area.

### Controls

#### *General*

- C1 Infill development is to comply with all relevant objectives and controls listed elsewhere in this chapter of the DCP. These objectives and controls are contained in sections including (but not limited to) C1.4 and C1.5.

- C2 If development is for a dual occupancy, the additional controls for dual occupancies in Part B, Chapter B3 General Development Controls of this DCP also apply (refer to Section B3.8 Additional controls for development other than dwelling houses).

*Character*

- C3 Infill development must:
- a) maintain the significant features and qualities that combine to represent the character of the neighbourhood and area;
  - b) not adversely affect the maintenance of elements that contribute to the significance of the heritage conservation area, for example sandstone walls; and
  - c) make a positive contribution to the character of the neighbourhood and area.

*Scale*

- C4 Infill development must not overwhelm its context and should be consistent with the predominant scale of significant contributory development adjoining the site or within the group/row. The scale of infill development must respect and take cues from the lowest adjoining contributory 19<sup>th</sup> or 20<sup>th</sup> century development in terms of:
- a) maximum height pattern (measured to the uppermost ridge of the principal buildings [or the base of the parapet where existing], not including chimneys); and
  - b) massing (building volume and size). On sloping streets, the stepped transitional height pattern must be achieved.

Refer also to Section 1.4.5 Building height, bulk, form and scale.

*Form*

- C5 Infill development must be consistent with the predominant built form (volume and configuration) of significant contributory development adjoining the site and in its immediate area in terms of aspects including, but not limited to:
- a) roof forms and pitch;
  - l) three dimensional modelling of neighbouring buildings;
  - m) modulation and articulation;
  - n) relationship of solids and voids;
  - o) fenestration patterns; and
  - p) relationship of floor to ceiling heights and horizontal alignment of features (especially ground and first floor levels of existing buildings on sloping sites and streets).

Refer also to Section 1.4.4 Roofs and roof forms, Section 1.4.5 Building height, bulk, form and scale, and Section 1.4.6 Site coverage, setbacks and levels.

---

### *Siting*

- C6 Infill development must adopt the established orientation pattern of the streetscape.
- C7 Where neighbouring buildings are orientated to face the street, infill development is to adopt the existing pattern of orientation.
- C8 Orientation across the site is not permitted unless there is a dominant pre-existing pattern in the street.
- C9 Where there is a uniform building front setback, the infill development must align with the existing setbacks of adjoining buildings.
- C10 Where building front setbacks vary, the following apply:
- If there is a dominant pattern and the infill development adjoins that pattern, the infill development must align with that pattern.
  - If there is no dominant pattern, the infill development must align with the existing adjoining development whose scale is more compatible with the proposed infill development. The pattern of setbacks must respect and take cues from the nearest contributory 19th or 20th century development and ensure that infill is recessive and does not visually dominate the streetscape.
  - If there is an existing stepped pattern, the infill development must be consistent with the pattern and proportion of the step.
  - If the infill development occurs on a corner site, the infill development must be sited on the street property boundaries to define the corner.
- C11 Rear and side setbacks (including side passages) must align with existing patterns, where visible from the public domain.
- C12 Infill development must be sited to:
- include sufficient deep soil landscaped area; and
  - have no adverse impact on significant trees on the site or adjoining land, including public land.
- Refer also to Section 1.4.8 Private open space, swimming pools, courtyards and landscaping.

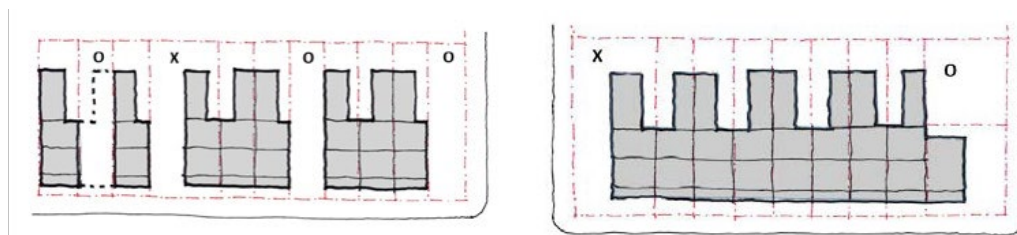
### *Materials, finishes, textures and colours*

- C13 Materials, finishes, textures and colours must be appropriate to the historic context. They must be similar to the characteristic materials, finishes, textures and colours of the existing contributory buildings within the streetscape.
- C14 Traditional materials may be used.
- C15 Contemporary materials may be permitted for infill development but only where their proportions, detailing, quantities and location on the building are in keeping with the character elements (refer to C1.2.3), the desired future character (refer to C1.2.4) and the heritage significance of the conservation area.
-

Note: for C13-C15:  
 Table 2 below sets out appropriate materials and finishes permissible for infill development.  
 Refer also to Section 1.5.9 Exterior colours.

C16 Infill development must:

- a) use render, masonry and/or timber;
- b) avoid large expanses of glass, reflective and metal wall cladding;
- c) use roof cladding which conforms with contributing neighbouring development;
- d) not have solid masonry front boundary walls; and
- e) use colour schemes which respect the character of the neighbourhood.



O = Acceptable infill site X = Unacceptable infill site

**TABLE 2** Materials and details for infill development

Building component	External building materials
<b>Roofs</b>	
Permitted	<ul style="list-style-type: none"> <li>▶ Traditional roof materials including natural slate such as Welsh slate and South Australian slate, corrugated galvanised iron in short lengths and associated galvanised details and fixings, or unglazed terracotta tiles.</li> <li>▶ Pre-painted corrugated steel in light to mid grey tones, similar in appearance to traditional corrugated iron.</li> <li>▶ Contemporary corrugated profile sheeting in appropriate colours and subject to low reflectivity.</li> </ul>
Intrusive - not permitted	<ul style="list-style-type: none"> <li>▶ Concrete roof tiles.</li> <li>▶ Non-traditional metal roof profiles.</li> <li>▶ Glass (other than permitted in skylights).</li> </ul>

Building component	External building materials
<b>Walls</b>	
Permitted	<ul style="list-style-type: none"> <li>▶ Traditional wall materials including sandstone blocks, timber weatherboard and brick.</li> <li>▶ Corrugated galvanised iron, zinc coated corrugated steel ripple iron for small expanses only. Must be in appropriate colours and subject to low reflectivity.</li> <li>▶ Rendered brick, with or without inscribed ashlar coursing where appropriate.</li> <li>▶ Fibrous cement sheeting with a rendered and painted finish - for rear additions but only if window reveals of minimum 100mm external depth are achieved.</li> </ul>
Intrusive - not permitted	<ul style="list-style-type: none"> <li>▶ Smooth, textured or profiled face brick and exposed concrete blocks.</li> <li>▶ Stripped sandstock brickwork.</li> <li>▶ Circular pattern render (mock Spanish).</li> <li>▶ Glazed walls and glass bricks.</li> <li>▶ Metal wall cladding.</li> <li>▶ Metal mesh or perforated metal screens.</li> </ul>
<b>Windows</b>	
Permitted	<ul style="list-style-type: none"> <li>▶ Timber frames.</li> <li>▶ Steel frames on rear ground floor only.</li> <li>▶ Metal frames for ground floor shops and commercial premises where appropriate.</li> <li>▶ Plain clear glass.</li> <li>▶ Coloured and patterned glass for replacement in appropriate situations.</li> <li>▶ Fine metal frames in neutral tones.</li> </ul>
Intrusive - not permitted	<ul style="list-style-type: none"> <li>▶ Window walls.</li> <li>▶ Bubble glass.</li> <li>▶ Glass blocks.</li> <li>▶ Timber or metal frames not reflecting traditional proportions.</li> <li>▶ Roller shutter security and sunscreen windows.</li> <li>▶ Horizontally sliding windows.</li> <li>▶ Aluminium framed windows in the front elevation and at the upper levels at the rear</li> </ul>

Building component	External building materials
<b>Doors</b>	
Permitted	<ul style="list-style-type: none"> <li>▶ Timber-framed panelled doors.</li> <li>▶ Glazed timber-framed doors.</li> <li>▶ Glazed steel-framed doors.</li> <li>▶ Glazed doors with film/frosted detailing.</li> </ul>
Intrusive - not permitted	<ul style="list-style-type: none"> <li>▶ Fully glazed doors to the street front elevation of residential properties.</li> <li>▶ Hollow core and timber doors with detail and panels inappropriate to the architectural style of the building.</li> <li>▶ Aluminium framed doors within the front elevation and at the upper levels at the rear.</li> <li>▶ Roller shutter doors to residential houses, retail and commercial premises.</li> </ul>
<b>Shutters</b>	
	<ul style="list-style-type: none"> <li>▶ Traditionally detailed timber louvered shutters are applicable for windows and French doors on some building types.</li> </ul>
<b>Verandahs</b>	
Permitted	<ul style="list-style-type: none"> <li>▶ Traditional flooring materials including stone flagging, marble, tessellated tiles, terrazzo, slate, timber.</li> <li>▶ Polished concrete and large form modern tiles.</li> <li>▶ Traditional post materials including stone, cast iron or timber.</li> <li>▶ Materials similar to traditional materials but without elaborate detailing.</li> </ul>
Intrusive - not permitted	<ul style="list-style-type: none"> <li>▶ Pebble-crete.</li> <li>▶ Polycarbonate or similar type material for roofs.</li> <li>▶ Glass roofs to street elevations.</li> <li>▶ Concrete roof tiles.</li> <li>▶ Non-traditional metal roof profiles.</li> </ul>

Building component	External building materials
<b>Balconies</b>	
Permitted	<ul style="list-style-type: none"> <li>▶ Traditional materials including corrugated iron roofing, slate roofing, timber framing, timber floors, timber balustrades/handrails, cast iron balustrades/handrails or modern-day equivalents.</li> <li>▶ Pre-painted corrugated steel in light to mid grey tones, similar in appearance to traditional corrugated iron.</li> <li>▶ Copper sheeting, zinc sheeting (traditional standing seam profile).</li> <li>▶ Contemporary corrugated profile sheeting in appropriate colours and subject to low reflectivity.</li> <li>▶ Masonry and metal, other than perforated metal or mesh.</li> </ul>
Intrusive - not permitted	<ul style="list-style-type: none"> <li>▶ Smooth, textured or profiled face brick and exposed concrete blocks.</li> <li>▶ Corrugated and other profiled metal sheeting balustrading.</li> <li>▶ Wire balustrading.</li> <li>▶ Fibrous cement sheeting balustrading.</li> <li>▶ Glass balustrading.</li> <li>▶ Perforated metal or mesh screens.</li> </ul>
<b>Front Fences</b>	
Permitted	<ul style="list-style-type: none"> <li>▶ Traditional fences but with consideration to building style and context, including rendered masonry with ashlar coursing, timber (picket or paling), iron palisade on sandstone, brick or rendered bases, brick and timber, or brick with iron inserts.</li> <li>▶ Contemporary interpretation of traditional fence details and materials such as iron palisade and timber.</li> </ul>
Intrusive - not permitted	<ul style="list-style-type: none"> <li>▶ Smooth, textured or profiled face brick, exposed cement blocks, Ti Tree (brush), or sheet metal fences.</li> <li>▶ Angled vertical blade palisade fencing.</li> <li>▶ Full height brick fences.</li> <li>▶ Materials and forms that are inappropriate to the style of the building.</li> </ul>

---

### C1.3.14 Intrusive buildings

---

Intrusive buildings within Paddington are generally 20th century buildings constructed after World War II. These are characterised by scale, proportions, materials and design idioms which are inappropriate to the significant historic character of Paddington.

Intrusive development adversely affects adjoining buildings, the streetscape and the general character of Paddington.

#### Objectives

- O1 To mitigate the adverse impact of intrusive development.
- O2 To encourage appropriate redevelopment of identified intrusive development.

#### Controls

- C1 Alterations must mitigate the impact of the scale, proportions, materials and design idioms of intrusive buildings and improve the relationship of these buildings to the streetscape.
- C2 Design for development on intrusive sites must demonstrate the application of contemporary design techniques, materials and finishes, scale, form, massing, details orientation and setting that respect the character of the adjacent historical context. The design must make a positive contribution to the character of Paddington.
- C3 Alterations must retain existing setbacks from side and front boundaries.



---

## C1.4 General controls for all development

This section applies to all development, including existing buildings and infill development.

The objectives and controls in this section seek to ensure that development is designed to respect the architectural character of the building and the context of the streetscape within Paddington.

The matters addressed in this section are:

- ▶ 1.4.1 Principal building form and street front zone of contributory buildings ;
- ▶ 1.4.2 Side elevations to streets and lanes;
- ▶ 1.4.3 Rear elevations, rear additions, significant outbuildings and yards;
- ▶ 1.4.4 Roofs and roof forms;
- ▶ 1.4.5 Building height, bulk, form and scale;
- ▶ 1.4.6 Site coverage, setbacks and levels;
- ▶ 1.4.7 Excavation;
- ▶ 1.4.8 Private open space, swimming pools, courtyards and landscaping;
- ▶ 1.4.9 Views;
- ▶ 1.4.10 Acoustic and visual privacy; and
- ▶ 1.4.11 Land subdivision and site amalgamations.

The controls in this section are to be read in conjunction with the controls in:

- ▶ Section C1.3 Building types; and
- ▶ Section C1.5 Specific policy for building and site elements.

---

### C1.4.1 Principal building form and street front zone of contributory buildings

---

Paddington is located in a natural amphitheatre with a variable and intricate street and laneway pattern, so views towards and within Paddington are often characterised by the juxtaposition of terrace houses responding to the changes in direction or slope.

Architectural detail and landscaping elements of the principal building form and street front zone may be individual to a particular building or repeated within a distinct group of terrace buildings. There exists subtle variation in these details throughout the heritage conservation area.

The loss of significant original fabric, in particular of the principal building form and street front zone, weakens the integrity of the heritage conservation area. Where work is proposed to the principal building form and the street front zone, reconstruction or restoration of missing elements and the removal of unsympathetic elements is encouraged. New work should be carefully designed sympathetically within the significant historic fabric.

#### Principal building form

The principal building form is the original front building section within a street frontage (see definition). The principal building form, particularly the front façade, is an aspect of exceptional significance of the heritage conservation area, facilitating the understanding of the significant development of the terraced suburb from the mid-19th century onwards.

The principal building form includes the fronts, sides, rears and roofscapes of the original front building section, and is often two rooms deep extending the full width of the property beneath a pitched roof.

External elements of the facades which are of importance include balconies and decorative balustrades, fin walls and arched recesses and original doors and windows. External elements of the roof which are of importance include, but are not limited to, original roof cladding and stepped flashing, parapets, decorative detail such as urns and ridge cappings, chimney stacks, chimney pots, form and scale.

#### Interiors

The interior of the principal building form is also of significance to the heritage conservation area. Surviving original fabric and layouts have the ability to demonstrate the significant 19th century character. Original elements which are considered of significance include, but not limited to, timber floors, fireplaces, decorative plasterwork and distinctive joinery.

Council does not support the gutting of interiors of terrace houses that contain significant original fabric. The objectives and controls in this part of the DCP identify approaches that applicants should take to prevent loss of significant fabric.

The objectives and controls also address the potential impact of weakening key internal walls through partial or total removal, in particular walls lateral to the party or common walls. The internal walls offer lateral bracing to the party walls and are an important element in the overall structural integrity of the terrace house and its neighbours in the terrace group. Accordingly, the removal of these walls essentially weakens the fabric of both the individual terrace house and of the terrace group.

While the retention of internal walls is important to interpret the historic layout of the building, their retention is also important in order to retain structural stability for terrace buildings. Partial demolition of internal cross walls within the principal building form may be considered where suitable interpretation of the position of walls and room proportions is provided and the structural integrity of the buildings is not compromised.

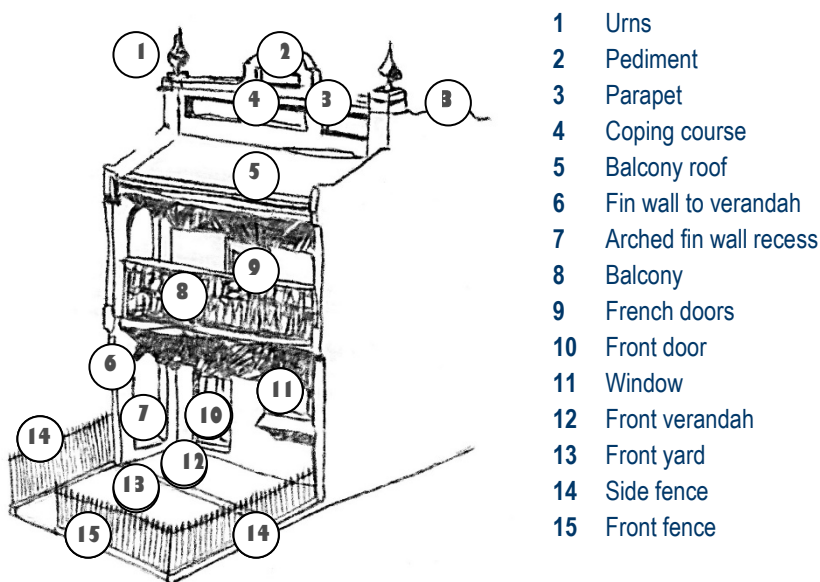
### Street front zone of contributory buildings

The street front zone establishes the connection between the private and the public domain. The predominant building form in Paddington is terrace style housing (generally attached dwellings or semi-detached dwellings as defined in Woollahra LEP 2014), which usually forms a continuous street front along the streets and steps down the hillside. The street front zone comprises the front building elevation and visible roof, front yard, the side boundary fences in the front yard and the street boundary fence.

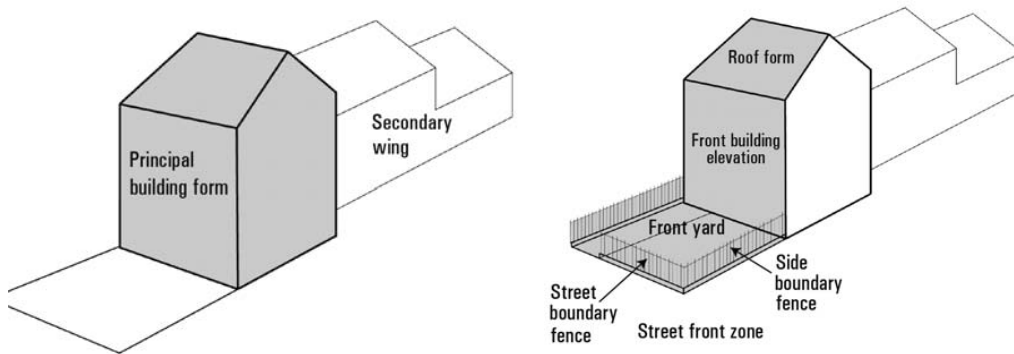
The street front zone also has a landscaped character, with features which enhance the architectural character of the building and contribute to the historic streetscape.

There are many variations in the relationship of the building to the street. Some simple Georgian style buildings are built on the edge of the pavement. Others are set back from the street with gardens. A typical Victorian period terrace has an iron palisade fence, a small garden, a path and a verandah, the latter two elements often incorporating decorative tiling. Its principal street front elevation is embellished with a high concentration of detail.

**FIGURE 5** Typical Victorian street front elevation



**FIGURE 6** Principal building form, secondary wing and street front zone.



### Objectives

- 01 To retain and conserve the principal building forms and street front zones.
- 02 To restore or reconstruct missing elements of the principal building forms and within the street front zone.
- 03 To encourage the removal of uncharacteristic elements or structures.
- 04 To promote design that conforms to the existing character of the area.
- 05 To reverse inappropriate reconstruction work.
- 06 To retain the distinctive shared characteristics of groups of buildings.
- 07 To retain, restore and promote the significance, contribution and relationship of a building within the context of a group of buildings.
- 08 To conserve the significant original fabric of terrace houses, terrace groups and free standing buildings of similar age and character.
- 09 To ensure the structural integrity of individual buildings and groups.
- 010 To retain and conserve external original fabric and features characteristic to a traditional terrace semi-detached dwellings or dwelling house.
- 011 To retain and conserve internal significant original fabric and features characteristic to a traditional terrace house.
- 012 To retain the historic framework of the building both as essential structure and as evidence of original patterns of construction and use.
- 013 To provide protection for potential heritage artefacts.

---

## Controls

### *Principal building form*

#### *Exterior controls*

- C1 The significant external elements of a principal building form are to be retained and conserved, that is:
- significant external fabric is to be retained and conserved;
  - characteristic elements such as roof pitches, eave heights and chimneys are to be retained and conserved;
  - no external alterations or additions are to be made to the significant elevations, details, materials or finishes of the principal building form except to allow for restoration or reconstruction;
  - the main rear wall to the principal building form should be left largely intact; and
  - significant verandahs and balconies are not to be infilled or enclosed.
- C2 When works are proposed to the principal building form or original significant elevations visible from the street, Council encourages, and may require, reconstruction or restoration of missing elements (where physical or documentary evidence of an earlier state exists) or reversal of uncharacteristic elements where:
- original render has been stripped from an external wall surface;
  - balconies or verandahs have been enclosed and details such as balustrade panels, rails, columns, friezes and fringes have been removed;
  - original door or window types and patterns have been removed;
  - roof cladding is in a unsympathetic material;
  - details are missing from chimneys; and
  - inappropriate reconstruction of period detail and elements has occurred.
- C3 Where a building forms part of a group, any work to the principal building form must be designed to retain the contribution and relationship of that building to the other buildings or building which comprise the group.
- C4 Where the building contains an existing basement level at the street front, no alterations or additions are to be made to the street front basement elevation or external staircase, except for the purposes of restoration or reconstruction of missing elements.
- C5 Where structural stabilisation is required, a sympathetic structural solution that retains original external fabric is required.
- C6 Where alterations are required to meet the Building Code of Australia, materials must be consistent with traditional material and finishes.

*Interior controls*

- C7 The significant original internal elements of the principal building form, in particular distinctive joinery, fireplaces and decorative plasterwork, are generally to be retained.
- C8 New openings in internal walls and floors and ceiling structures lateral to party walls must retain the structural integrity of the building and its neighbours, and should retain the significant original ceilings and cornices. Interpretation of original wall positions and room proportions should be provided. The revised structure may incorporate suitable portal frames.
- C9 Where structural stabilisation is required, a sympathetic structural solution that retains original internal fabric is required.

*Street front zone*

- C10 The location, form and materials of original stairs must be retained. Risers and treads may be reconfigured to conform with BCA requirements.
- C11 All original windows and doors including those to basement levels are to be retained.
- C12 Non-original doors and windows shall be reconfigured to a traditional type consistent with the architectural style of the building and, where evidence exists of the original doors and windows, they are to be replicated.
- C13 Original fences that have been replaced by intrusive fences should be replaced.
- C14 When works are proposed in the street front zone Council encourages, and may require reconstruction or restoration of missing elements or reversal of uncharacteristic elements.
- C15 Where a building forms part of a group, any work in the street front zone must be designed to retain the contribution and relationship of that building to the other buildings or building which comprise the group.

---

## C1.4.2 Side elevations and side additions

---

Side elevations or secondary elevations are less detailed than the main street front elevations. Side elevations of Victorian terrace houses are often built to the street boundary with a strong gabled form reflecting the pitch of the main roof and a lower skillion section at the rear.

Due to the high visibility from streets and laneways, changes to side elevations and additions require an approach that retains the architectural form and character of the building.

Some sites have the opportunity to develop additions to the sides or adjacent to the principal building form between a row of buildings. Where these are on the same registered land parcel, and where they do not affect 'night soil' or right of way passageways, they may be developed in accordance with the following provisions below. Significant 'night soil' or right of way passageways are to be retained in place and interpreted without additional structures other than fencing.

Note: Side elevations are to a street or lane, whilst side additions adjoin other buildings.

Refer also to corner terrace style houses in Section 1.3.3 Corner buildings and other relevant sections in C1.3 Building types.

### Objectives

- 01 To retain and conserve the architectural character of side elevations of contributory buildings.
- 02 To ensure that side additions are of sympathetic design and construction to the original building.
- 03 To ensure that side additions to existing buildings are designed and located to achieve a cohesive relationship between the existing buildings, and retain and enhance the significance of the heritage conservation area.
- 04 To ensure that side additions respect the scale and setting of adjacent contributory buildings.
- 05 To protect the amenity of adjoining or adjacent residential uses.

### Controls

#### *Side elevations - street and lane*

- C1 Original side elevations of contributory buildings including original fabric, side entrance doors, windows, balconies and other details are to be retained and conserved.
- C2 Minor alterations to a side elevation of the principal building form or the secondary wing will be permitted if they do not impact on the architectural form and character.
- C3 Changes to the roof pitch of the principal building form of contributory buildings are not permitted.

*Side additions - street and lane*

- C4 Additions must be consistent with traditional patterns and proportions of openings and the materials and detailing of the existing building.
- C5 The overall length of any addition is to be less than, and appear as a form secondary to, the existing building.
- C6 The addition of balconies is not permitted when the building is built to the side street boundary.
- C7 Additions must retain the profile of existing traditional party walls and their associated parapets.
- C8 Additions shall reflect the existing setbacks.
- C9 Where there is a uniform building front setback, the side addition must be set back behind the front wall of the principal building form (not including the balcony) to which it is attached and adjoining buildings.
- C10 Where building front setbacks vary, the side addition must be set back behind the front wall of the principal building form (not including the balcony) to which it is attached.
- C11 Side boundary fencing shall reference traditional height, forms and materials.

*Side additions between buildings*

- C12 Side additions must:
  - a) maintain the significant features and qualities that combine to represent the character of the neighbourhood and area;
  - b) make a positive contribution to the character of the neighbourhood and area; and
  - c) maintain a contextual relationship between the existing building to which it is attached, the adjoining buildings and the streetscape in which it will be located by maintaining the development pattern.
- C13 Side additions must not overwhelm the context and should be subservient to and consistent with the predominant scale of the building to which it is attached, significant development adjoining the site and in the group/row in terms of:
  - a) maximum height pattern (measured to below the gutter line of the principal building form to which it is attached [or the base of the parapet where existing], not including chimneys); and
  - b) massing (building volume and size).
- C14 Side additions must be consistent with the predominant built form (volume and configuration) of the building to which it is attached and significant development adjoining the site and in its immediate area in terms of aspects including, but not limited to:
  - a) roof forms and pitch;



- 
- b) three dimensional modelling of neighbouring buildings;
  - c) modulation and articulation;
  - d) relationship of solids and voids;
  - e) fenestration patterns; and
  - f) relationship of floor to ceiling heights and horizontal alignment of features (especially ground and first floor levels of the existing buildings to which it is attached).

Refer also to Section 1.4.4 Roofs and roof forms, Section 1.4.5 Building height, bulk, form and scale, and Section 1.4.6 Site coverage, setbacks and levels.

- C15 Side additions must adopt the established orientation pattern of the existing building to which it is attached.
- C16 Where there is a uniform building front setback, the side addition must be set back behind the front wall of the principal building form (not including the balcony) to which it is attached and adjoining buildings.
- C17 Where building front setbacks vary, the side addition must be set back behind the front wall of the principal building form (not including the balcony) to which it is attached.
- C18 If the side addition occurs on a corner site, the controls in C1.4.2 apply.
- C19 Rear and side setbacks (including side passages) must align with existing patterns, where visible from the public domain.
- C20 Side additions must be sited to:
  - a) include sufficient deep soil landscaped area; and
  - b) have no adverse impact on significant trees on the site or adjoining land, including public land.

Refer also to Section 1.4.8 Private open space, swimming pools, courtyards and landscaping.

- C21 Materials, finishes, textures and colours must be appropriate to the historic context. They must be similar to the characteristic materials, finishes, textures and colours of the existing building to which it is attached and existing contributory buildings within the streetscape.
  - C22 Contemporary materials are permitted where their proportions, detailing, quantities and location on the building are in keeping with the character elements (refer to C1.2.3) and the desired future character of the heritage conservation area (refer to C1.2.4).

Refer also to Section 1.5.8 Materials, finishes and details and Section 1.5.9 Exterior colours.
  - C23 Side additions must:
    - a) use render, masonry and/or timber;
-

- b) avoid large expanses of glass and reflective wall cladding;
- c) if visible from the street or public domain, use roof cladding which matches the existing building to which it is attached;
- d) not have solid masonry front boundary walls; and
- e) use colour schemes which respect the character of the neighbourhood.

**Note:**

For side additions between buildings, a draft site and context analysis is to be submitted to Council for comment as part of a predevelopment application meeting between Council representatives and the applicant.

The following information is to be submitted for comment prior to the lodgement of the development application:

- ▶ design options explored and the applicant's preferred design proposal;
- ▶ a statement outlining the proposed measures to minimise the adverse impact of the side addition on neighbouring lands, including the public domain;
- ▶ the philosophy of how the design elements relate to the proposal's context in terms of architectural form, materials and character; and
- ▶ the historic context and impact sections of a draft statement of heritage impact.

For development applications, applicants are required to provide the following information, not limited to:

- ▶ design options and final preferred design;
- ▶ a detailed site and context analysis;
- ▶ profiles of adjoining development;
- ▶ RLs for the subject site and adjoining properties;
- ▶ an accurate survey (including RLs, and the accurate location of eaves/gutters, chimneys and other structures on adjoining properties);
- ▶ the structural relationship with the existing building and any adjoining properties (including shared party walls, footings and chimneys); and
- ▶ the final version of the statement of heritage impact.

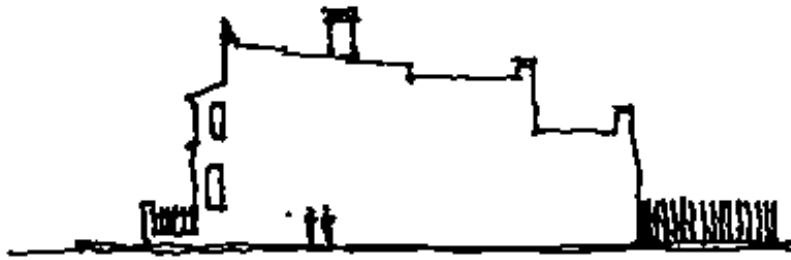
Other required documentation to be submitted with the development application can be found in the Development Application Guide.

**FIGURE 7** Side elevations



There is a variety of shapes and forms, but the general treatment of visible side elevations is simpler than the front elevations.

Ornamentation is rare and in the expanse of walls, fenestration is limited.



---

### C1.4.3 Rear elevations, rear additions, significant outbuildings and yards

---

There is a distinct visual contrast between the front and the rear of houses.

In a typical Victorian terrace, the highly decorative front contrasts with the restrained and utilitarian finish at the rear. Traditional rear additions are smaller in scale than the main house, with simple forms punctuated with vertically proportioned window openings. The rear of the Victorian style double storey terrace is often characterised by a one or two storey structure, commonly under a single pitched or skillion roof which maintains a side breezeway. The simple pitched or skillion roof form on rear elevations is visible, unlike the front elevation roof which may be screened by a parapet. Street corner buildings sometimes employ a parapet to both front and side elevations. Frequently rear elevations are paired with a neighbouring property.

There is a distinct typology of rear building forms within Paddington. Due to the elevated siting and topography of Paddington, many rear forms of buildings are highly visible.

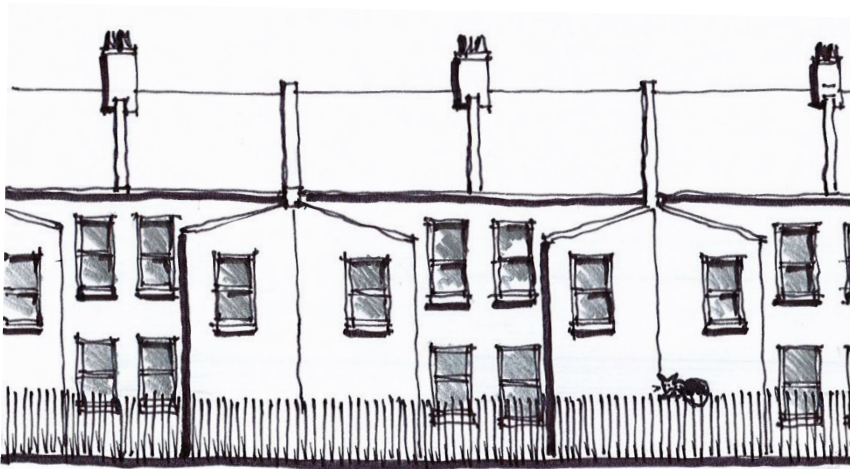
Some rear building forms survive in unaltered groups of houses and contribute significantly to the character of the heritage conservation area.

An unaltered group is defined as a building or group of buildings that has retained its original form and character, there may be some minor changes to windows and doors or the loss of some original detail, but notwithstanding the original form and character of the group is generally retained.

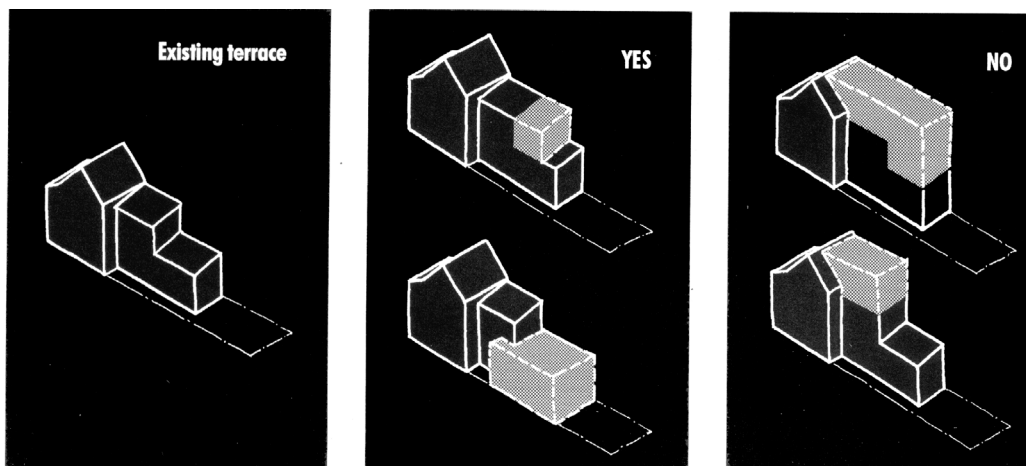
Traditionally the rear yard of 19th century housing was utilitarian in use and character, usually enclosed by a paling fence with a gate leading to a laneway. Many groups of houses such as terrace houses had a rear passageway for servicing outdoor rear yard brick toilet structures. The remaining 'night soil passageways' and rear yard outdoor toilet structures are a significant element in Paddington. Remnant stable structures are rare.

#### Objectives

- 01 To retain the forms and character of traditional rear elevations of contributory buildings, particularly where they exist in unaltered groups.
- 02 To ensure that rear alterations and additions are of sympathetic design and construction.
- 03 To ensure that the distinctive shared characteristics of groups of contributory buildings are retained and enhanced.
- 04 To enable sympathetic contemporary design and use of contemporary materials in appropriate circumstances.
- 05 To ensure that significant outbuildings are retained and conserved.

**FIGURE 8** Rear elevations

Where a coherent group of rear elevations exist, any development should occur within the existing envelopes. New development which ignores its context will not be permitted.

**FIGURE 9** Rear additions

Rear extensions should respect the traditional hierarchy of scale and form. Greater freedom is permitted of the architectural treatment of ground floor extensions than for visible upper floor additions.

## Controls

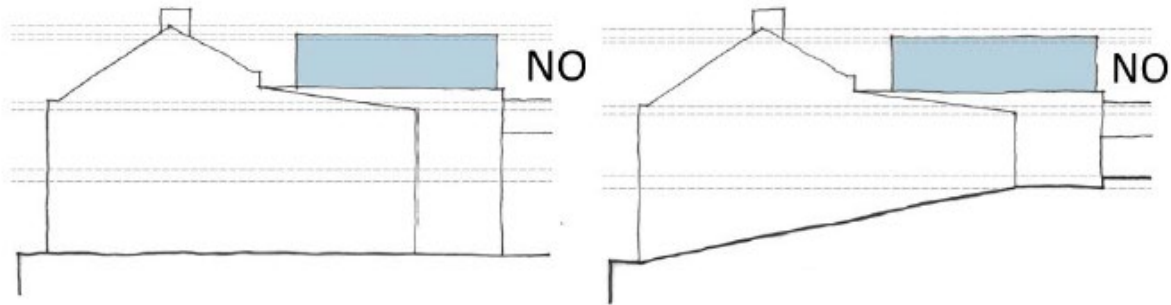
### *Rear additions*

- C1 Alterations and additions to a building which comprises one of a group, or pair, must be designed with regard to the overall balance of the group, or pair, in terms of height, alignment, form, scale, breezeway pattern and architectural character and detail.
- C2 The roof of an extension or the new roof for an existing component must be of traditional form appropriate to the building type.
- C3 Roofs must be visible and not screened partly or wholly by features such as parapets. The exception may be corner sites. Parapet roof forms may only be considered appropriate

where it can be demonstrated that a parapet form is consistent with the bulk, scale and character of the existing building and group.

- C4 No part of a rear alteration and addition can be higher than the gutter line of the principal building form (chimney excluded).

**FIGURE 9A** Intrusive development: rear additions showing additional levels above the gutter line which are not supported by C5. The difference between the two drawings is the topography of the site.



- C5 Alterations and additions at the rear of buildings must:
- a) not dominate or otherwise adversely compete with the form, height, proportions and the scale of that part of the building which is to be retained;
  - b) not reproduce or match a building which in terms of its height, bulk, scale and detailing is inappropriate to the heritage character of the area;
  - c) retain traditional solid to void ratios on elevations visible from the public domain;
  - d) not employ large areas of glass on upper levels;
  - e) be designed to minimise or avoid an adverse impact on neighbouring properties in terms of overlooking, loss of sunlight and ventilation;
  - f) not extend beyond the predominant rear building setbacks at any level of a group or row of buildings; and
  - g) retain all original chimneys.
- C6 Building boundary to boundary on the ground floor level is permissible provided that:
- a) the development does not adversely affect the privacy, ventilation, light and the amenity of the adjoining properties; and
  - b) the development does not disrupt an existing pattern of a group of unaltered contributory buildings.
- C7 Additions are not permitted where single or double storey rear skillion forms exist in an unaltered group. In such cases alterations are to occur within the existing building envelope.
- C8 Where significant original decorative internal elements exist outside of the principal building form they are generally to be retained.

*Unaltered groups*

- C9 Unaltered groups with single storey rear wings must retain their single storey form. Single storey, courtyard housing style additions with attic rooms may be permitted, where the addition does not result in view loss of the main wing from the public domain.

*Contemporary design*

- C10 Sympathetic contemporary design may be permitted at the rear where:
- a) intrusive fabric or fabric of low significance exists;
  - b) the proposal will achieve an aesthetically cohesive relationship between new and existing fabric; and
  - c) the proposal is consistent with the character of the site, the streetscape and the precinct in which it is contained.

*Significant structures and areas at the rear*

- C11 If development is in the form of a dual occupancy, the additional controls for dual occupancies in Part B, Chapter B3 General Development Controls of this DCP also apply (refer to Section B3.8 Additional controls for development other than dwelling houses) .
- C12 Significant backyard toilet structures on rear laneways are to be retained in place if they are one of a group of at least two adjacent original toilets.
- C13 Significant 'night soil' passageways are to be retained in place and interpreted without additional structures other than fencing.
- C14 Significant ancillary structures including stables, coach houses and wells in the rear yard are to be retained in place.

---

### C1.4.4 Roofs and roof forms

---

Main roof forms vary with building types and architectural styles. Cottages have hipped or gable roof forms, or a combination of the two. In terrace housing there are two predominant roof forms. Some roofs are pitched both ways from a central ridge. This is often articulated by the projecting gabled party walls. Corner terraces have segmented hipped forms which address the corner site or composite roofs concealed behind a parapet. Less common is the skillion roof form terrace with a parapet to the street front that steps down along the side elevation.

Below main roof forms there are verandah roofs. Some are stepped down from the main roof. They have distinct profiles and include convex or concave and skillion profiles depending on the architectural character of the building.

There are also secondary roof forms. Lower roofs to rear additions are generally skillion forms. When paired with a similar property, roofs produce patterns of gabled forms to the rear of properties. The simple pitched or skillion roof form on rear elevations is visible, unlike the front elevation roof which may be screened by a parapet.

The earliest roofs in the original Paddington village were covered in timber shingles. Later materials used throughout Paddington are slate, corrugated galvanised iron and zinc coated corrugated steel. Consistent with the style, roofs of Federation period buildings have the characteristic unglazed terracotta tiles.

Associated with the roof and the roofscape are a number of important elements such as traditional flashings, barge rolls, eaves and ridge detailing.

The arrangement of terraces stepping down the hills of Paddington affords views to the roofs. As a consequence, the roofscape is a significant element in the urban character of Paddington.

Replacement of original roofing materials with concrete tiles or glazed tiles, and the replacement of original roof details such as the covering over of lower verandah roof profiles are eroding Paddington's roofscape.

#### Objectives

- O1 To retain and conserve the character of the original roofscape of Paddington.
- O2 To restore or reconstruct missing roof elements.
- O3 To ensure that contemporary roof forms are consistent with the historic roofscape character of Paddington.
- O4 To ensure that the roof form and pitch of upper storey rear additions is consistent with the roof form and pitch of the existing group or pair.

#### Controls

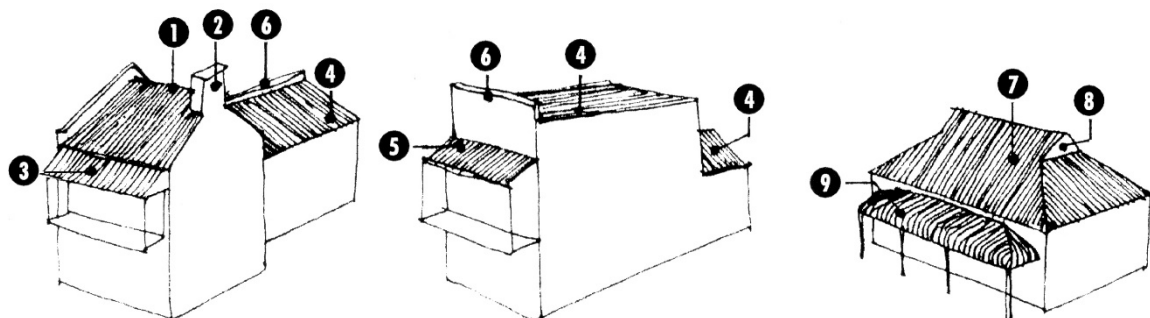
- C1 The removal of original roofing materials and their details is not permitted unless deteriorated materials are replaced by the same or similar materials and details.



- C2 Existing patterns of roof forms within groups of unaltered buildings must be retained.
- C3 The roofscape of the principal building form of contributory buildings is to be retained. The possible exceptions are:
- a) a dormer and skylight to the rear roof slope where permitted under Section 1.5.1 Dormers and skylights; and
  - b) a dormer to the front roof slope where permitted under Section 1.5.1 Dormers and skylights.
- C4 Missing roof elements must be reinstated when unsympathetic roofs are replaced.
- C5 Secondary or rear roof forms must not be raised or altered if the rear skillion forms part of a group of similar roof forms. The possible exception is a dormer and a skylight to the rear roof slope. Refer to Section 1.5.1 Dormers and skylights.
- C6 Roof forms are to be consistent with appropriate traditional roof forms, which reflect the diminishing scale of roofscapes towards the rear of buildings.
- C7 Reverse skillion roof forms are not permitted to contributory buildings.
- C8 Roofs are to be clad in materials with profiles that are appropriate to the architectural style of the building. Appropriate materials are described in Section 1.5.8 Materials, finishes and details.
- C9 Unsympathetic roofing materials must only be replaced by roof cladding in either traditional materials or in contemporary materials, which are similar in appearance and profile to traditional materials.
- C10 Rear roof planes are not to incorporate more than 25% transparent material. This includes the area of skylights and dormer windows.
- C11 New rear additions to multi-storey buildings must remain consistent with the group or pair in terms of roof form and roof pitch.

**FIGURE 10** Roof elements

- |                 |                         |                           |
|-----------------|-------------------------|---------------------------|
| 1 Gable roof    | 4 Skillion roof         | 7 Hipped roof             |
| 2 Chimney stack | 5 Skillion balcony roof | 8 Gablet                  |
| 3 Balcony roof  | 6 Parapet               | 9 Bullnosed verandah roof |



---

### C1.4.5 Building height, bulk, form and scale

---

Building heights in Paddington vary with the type of building but generally there is a predominance of two and three storeys. An important part of the character of a group of buildings can be its uniform height particularly when viewed from the street frontage.

Less prevalent in numbers are single storey terrace groups and individual single storey buildings. Many of these single storey buildings and groups are highly significant because of their rarity and because they represent a particular building type in the early historic development of the area.

The bulk, form and scale of buildings in Paddington are also important contributing elements to the character of the area generally and to the character and significance of groups of buildings.

The height bulk, form and scale of new development have the potential to adversely impact on the amenity of private and public lands.

#### Objectives

- 01 To retain the distinctive height, bulk, form and scale of particular building types.
- 02 To retain the existing heights of single storey buildings.
- 03 To maintain the visual consistency of established heights in historically significant streetscapes.
- 04 To ensure that the height of new development conforms to the appropriate heights in the street or lane and the historic character of the street or lane.
- 05 To minimise the impact of new development on the access to sunlight for private properties and public places such as neighbourhood parks.
- 06 To protect the amenity of adjoining or adjacent residential uses.

#### Controls

- C1 The height of existing buildings on street frontages must not be increased.
- C2 Upper floor additions to significant single storey buildings, which will result in an increased building height, are not permitted. This will apply irrespective of whether the single storey building adjoins or is located between higher buildings.
- C3 The height, bulk, form and scale of infill and new development must be consistent with the predominant height, bulk, form and scale of appropriate adjoining buildings. Conformity with adjoining buildings is not appropriate in circumstances where the development site adjoins a building which is a substantially taller landmark building, or is a building considered to be intrusive due to its excessive height and incompatible design.
- C4 Infill development and alterations and additions must be designed and sited so that sunlight is provided to at least 50% or 35m<sup>2</sup> with minimum dimensions of 2.5m, whichever is the lesser, of the main ground level private open space of adjoining properties for a

minimum of two hours between 9am and 3pm on 21 June. Where existing overshadowing is greater than this, sunlight is not to be further reduced.

- C5 Where adjoining dwellings have greater than three hours of sunlight to a habitable room, the north facing windows to the habitable room are not to have sunlight reduced to less than three hours between 9am and 3pm on 21 June.
- C6 New dwelling houses are to have at least one habitable room with windows which receive at least three hours of sun over a portion of their surface between 9am and 3pm on 21 June.
- C7 Storey heights must conform to those of appropriate adjacent buildings.

---

### C1.4.6 Site coverage, setbacks and levels

---

Paddington is notable for a predominant pattern of repetitive terrace building types on long rectangular blocks running between streets and laneways.

The prevalent street alignment is close to the street. Setbacks from street boundaries vary overall from nil to setbacks that allow the establishment of large gardens.

Within rows of buildings there are varied front and rear alignments depending on whether the building is one of a group of similar buildings, a pair or an individual building. Occasionally a building is a one-off building located on a corner site.

Terraces with east-west orientation step down reflecting the topography of the hills. Terraces with north-south orientation sometimes incorporate a basement level taking up the fall of the site.

Terraces were a speculative building type where the group of terraces usually relies on the structural integrity of the group. The footings to a row of terraces may be considered minimal by current building standards and subfloor drainage poor. Structural and groundwater alterations to one terrace may have an adverse impact on others in the area.

#### Objectives

- 01 To maintain setbacks along the street frontage.
- 02 To retain established building alignments, setbacks and levels.
- 03 To ensure that new development continues the established alignments and setbacks of the established historic development in the streetscape.
- 04 To ensure that the siting of new development responds appropriately to levels established by relevant historic development in the streetscape.
- 05 To retain and protect front yards and their significant fabric.
- 06 To encourage the retention or creation of useable open space at the rear of sites.

#### Controls

##### *Site cover*

- C1 The proportion of building footprint is to be consistent with similar properties in the immediate vicinity.

##### *Setbacks*

- C2 Existing setbacks on street frontages are to be maintained.
  - C3 Siting and setbacks of all structures are to continue the immediate established patterns.
-

- C4 New development outside a commercial area is not to be built forward of existing building alignments.
- C5 The existing siting pattern within the commercial area is to be maintained.
- C6 Additions at the rear of buildings in the commercial areas must not extend beyond the rear setbacks of adjacent contributory buildings. In such cases, balconies may project beyond the rear setback.

*Levels*

- C7 New development is to be consistent with ground and first floor levels established by existing buildings and topography in the context of a sloping site.

---

### C1.4.7 Excavation

---

The geology of the Paddington area varies from sandstone, loose sandy soils or a combination of sandy soils overlaying a sandstone stratum. Other foundation materials are very rare and less problematic than the worst case of sand over rock.

There are some site typologies where excavation for the purposes of establishing a basement may be considered reasonable. However, it should be recognised that the majority of the site typologies in Paddington do not lend themselves to excavation. The objectives and controls in this section are informed by an understanding of the methods involved, and potential impact, of excavating certain foundation types.

The majority of the common walls between terrace style housing in Paddington are constructed of sandstock bricks and lime mortar on brick footings or on sandstone blocks. The density of development in Paddington has resulted in many buildings, primarily groups of terrace row style housing, with a shared structural system of footings, common party walls and lateral cross walls. These walls are interconnected and interdependent brick walls set over a number of properties.

Excavation together with alteration of these footing systems can have detrimental effects on an individual property and also impact on neighbouring properties within a terrace group. The original footings and walls, built to differing standards, cannot tolerate any foundation movement without cracking and sometimes structural failure. Council's records provide evidence that excavation works under and near common wall footings have caused damage to the significant original fabric of many buildings in Paddington.

The objectives and controls below apply to any excavation proposed under the principal building form (refer to Section 1.4.1 Figure 6), secondary wing, or any other location on a property. The controls require an understanding of the subsurface conditions, and seek to protect the structural integrity of the individual building, the row of houses of which it is a part, adjoining properties, and their heritage significance.

Excavation is controlled in order to preserve the heritage fabric and structural integrity of buildings that collectively contribute to the significance of Paddington.

Excavation and below ground construction can also impact on natural groundwater flows, resulting in potential damage to buildings. Most masonry terrace houses and Victorian cottages do not have cavity walls or damp proof courses, which may result in rising damp and the potential for mould internally. Maintaining subfloor ventilation is an important part of controlling damp for it allows soil moisture to evaporate beneath the floors and to pass out through the air vents in the walls.

Replacing a timber floor with an on-ground concrete slab within a building without damp proof courses will usually direct the soil moisture towards the walls, creating a rising damp problem. Changing the natural groundwater pattern other than by controlling the direction of groundwater by through-site systems may result in a 'damming effect', which may result in rising damp problems.

The objectives and controls contained in this part have adopted the principle of precautionary behaviour, one of several principles that form the basis of ecologically sustainable development.

---

**Note:**

The following information must be submitted with the development application:

- ▶ A geotechnical report that identifies surface and substratum conditions and survey levels of original footings and walls. The report must be prepared in accordance with Council's guidelines.
- ▶ A structural report that cross-references the geotechnical report and identifies the structural systems to be employed to maintain structural integrity.
- ▶ Construction details for any new wall in the vicinity of any original external wall. Surveyed levels of the original building fabric are to be included.

In granting a development consent, Council may impose a condition requiring the preparation and submission of pre-commencement and post-completion dilapidation reports for properties adjoining and neighbouring the development.

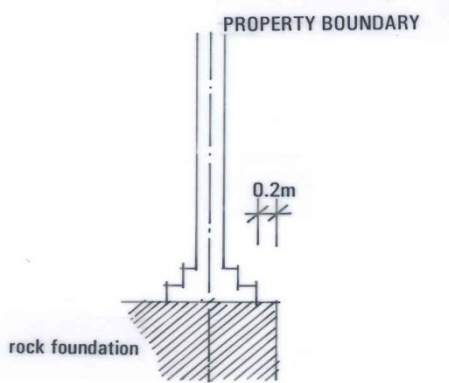
Applicants may also require consent under the *Heritage Act 1977* or the *National Parks and Wildlife Act 1974* for the excavation of land which is known or suspected to have archaeological potential.

**Objectives**

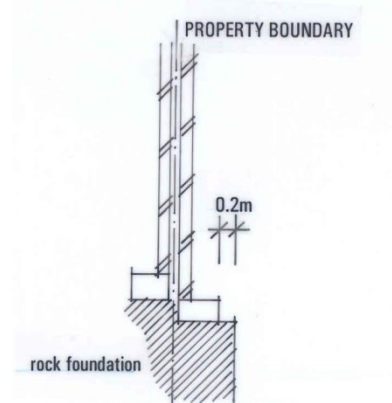
- 01 To ensure the structural integrity and stability of individual buildings and the terrace of buildings of which they are a part, and neighbouring properties.
- 02 To protect the original fabric of the buildings significant to the area both during and after excavation.
- 03 To ensure that objectives 01 and 02 are achieved by limiting the circumstances where excavation may occur.
- 04 To limit the impact of excavation on the natural landform and vegetation.
- 05 To relate development to the existing topography and existing ground levels.
- 06 To avoid potential damage to all buildings and structures during and after excavation.
- 07 To ensure that any new floor levels resulting from excavation and development do not compromise external heritage features of the building or those of its neighbours.
- 08 To ensure that habitable rooms created by excavation are supplied with adequate natural light and ventilation in order to meet sustainable building principles.
- 09 To maintain natural subsurface ground water flows.
- 010 To recognise the protection necessary for potential archaeological objects.

FIGURE 11 Guidelines for excavation

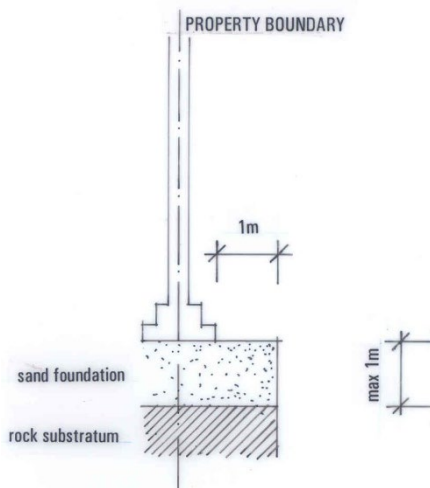
Common party wall



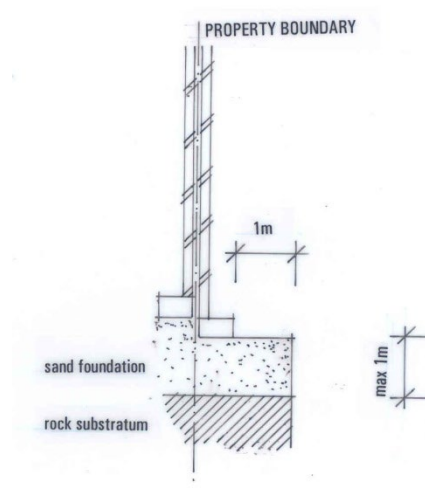
Freestanding boundary wall



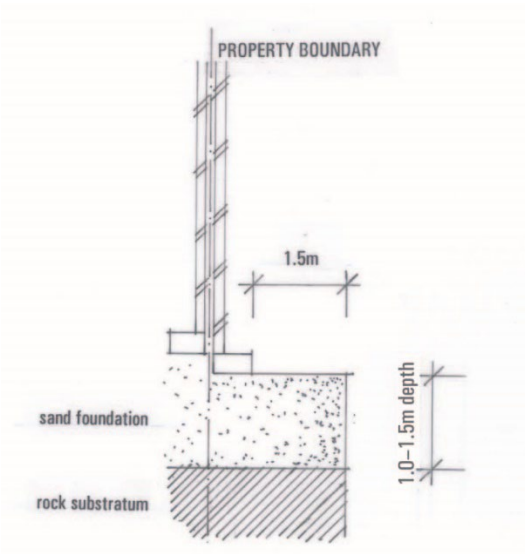
Common party wall



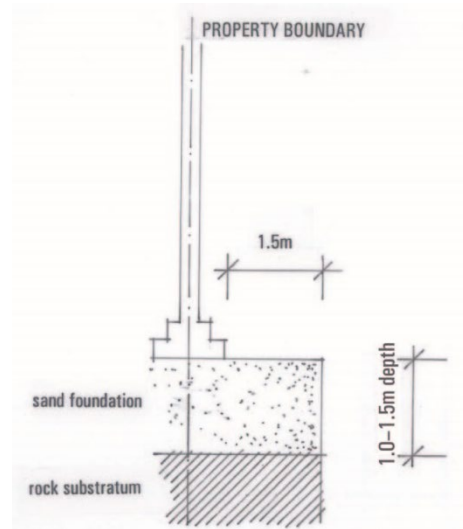
Freestanding boundary wall



Common party wall



Freestanding boundary wall





---

## Controls

### General

- C1 Excavation will not be permitted if:
- a) it will occur under common walls and footings to common walls, or freestanding boundary walls, or under any other part of adjoining land; and
  - b) it will occur under or forward of the front façade; and
  - c) the outer edge of the excavation is within 0.2m of the footings of the front wall, party walls, or freestanding boundary walls, where the existing footing has bearing directly on rock foundation; or
  - d) the outer edge of the excavation is within 1m of the footing of the front walls, party walls, or freestanding boundary walls, where the existing footing has bearing on sand foundation or sandy soils up to 1m deep over a rock substratum; or
  - e) the outer edge of the excavation is within 1.5m of the footing of the front wall, party walls, or freestanding boundary walls, where the existing footing has bearing on sand foundation or sandy soils of a depth greater than 1m but not more than 1.5m over a rock substratum;
  - f) the rock substratum is greater than 1.5m below original footings; and
  - g) habitable rooms formed from the excavation:
    - do not have at least one external wall fully above existing ground level; and
    - will not receive adequate natural light and ventilation; and
  - h) a geotechnical and structural report cannot ensure that the works will not have any adverse effect on the neighbouring structures. The report must be prepared in accordance with the Council’s publication ‘Guide for preparing Geotechnical and Hydrogeological Reports’;
  - i) the removal of the existing floor structure above the excavation is required in order to carry out the excavation other than the temporary, partial removal of floor boards to allow exploratory investigation of subsurface conditions.

Note: The above diagrams are not definitions but are provided to assist with interpretation of the controls. Front façade includes the outer edge of balconies and verandahs.

- C2 In order to prevent damp problems for the subject building or any neighbouring properties, all buildings that do not have damp proof courses within their party walls, must have timber floor at the lowest floor level.
- C3 For a subsurface structure, an effective groundwater drainage system must be incorporated within the design. This will not be required in cases where the applicant demonstrates through a hydrogeological report that:

- a) the works will not affect groundwater flows; and
  - b) the proposed development will not have an adverse impact on the existing moisture level of an original external wall of an adjoining building which contributes to the significance of Paddington, especially those without existing damp proof courses.
- C4 The ground and first floor levels of alterations and additions and infill development are to be consistent with the levels established by existing buildings and topography on adjoining sites.
- C5 Despite C1, minor excavation may be allowed in the following cases:
- a) maintenance or replacement of existing footings and subfloor walls;
  - b) maintenance or repair of existing essential services or the introduction of new essential services.
- Note: Services include sewer and drainage.

*Excavation for garage structures*

- C6 Boundary to boundary excavation may be permitted for garage structures on rear laneways if:
- a) the structure complies with Section 1.5.6 On-site vehicle parking, garages, carports, driveway access and servicing facilities;
  - b) the structure does not adjoin the principal building form or secondary wing of a building constructed on the common boundary of an adjoining site; and
  - c) no original footings on adjoining sites will be disturbed.

*Excavation for other structures beyond the principal building form or secondary wing*

- C7 Excavation may be permitted for structures such as pools, spas, or other permissible development if:
- a) for properties less than 6m in width, the outer edge of excavation is setback from side boundaries by at least 900mm;
  - b) for properties 6m or more in width, the outer edge of excavation is setback from side boundaries by at least 1.5m;
  - c) the lowest habitable room, if any, of the proposed development has at least one external wall fully above the existing ground level;
  - d) no original footings on an adjoining property will be disturbed; and
  - e) a geotechnical report ensures that works will not have any adverse effect on the neighbouring structures. The report must be prepared in accordance with Council's guidelines.

---

### C1.4.8 Private open space, swimming pools, courtyards and landscaping

---

Paddington's characteristically small lots with boundary to boundary buildings provide limited opportunities for ground level open space and landscaped areas.

In many instances with residential properties, a small landscaped area occurs in the street front zone. This area creates an open appearance and provides visibility to and from the street, both of which are important to the setting of each building and to the streetscape. There is greater scope for useable private open space and landscaping at existing ground level at the rear of residential properties, and Council requires that the principal area of private open space is located at the rear.

For residential flat buildings and manor houses, including those built as infill development or those which adapt existing buildings, open space may be provided as private and communal areas. In these buildings private open space may be provided at ground or above ground level. The latter may comprise balconies and verandahs.

Roof terraces are not characteristic of Paddington and are not generally acceptable as private or communal open space. Further, because of the dense built character and sloping landform of Paddington, use of roof terraces can produce detrimental impacts on privacy due to overlooking and noise transmission.

The amount and composition of landscaped open space play important roles in stormwater management, energy efficiency of developments and access to sunlight. Trees and vegetation can support indigenous wildlife populations and habitat.

Deep soil landscaped area is an important element of the overall landscape capabilities on a site. To be effective, deep soil landscaped area needs to be a suitable size, configuration and location to sustain medium to large vegetation. This means there needs to be adequate width and depth of soil profile for root volumes and long term stability of vegetation.

Refer to Section 1.5.10 Gardens and trees for specific objectives and controls for gardens and trees.

#### Objectives

- O1 To maintain open areas at the front of buildings and their visibility from the street.
- O2 To retain and reinstate traditional landscaping and open areas at the front of buildings.
- O3 To maintain an area at the rear of each site which enables planting at natural ground level and assists on-site drainage.
- O4 To ensure that provision is made for accessible and useable private open space at the rear of properties.
- O5 To ensure the provision of semi-permeable and permeable areas of open space in rear gardens to assist with on-site drainage.

- O6 To ensure that the design and use of private open space areas has regard to environmental impact, impact on the fabric of adjoining properties, infrastructure, and on the amenity of the occupiers of adjoining properties.
- O7 To ensure that trees and other vegetation do not have an adverse impact on the fabric of buildings, and that works have no or minimal adverse impact on the amenity of the occupiers of properties.
- O8 To ensure adequate and reasonable acoustic and visual privacy for neighbours.
- O9 To ensure provision of adequate deep soil landscaped area capable of sustaining medium to large vegetation.

## Controls

### *Open and unbuilt upon area and deep soil landscaped area*

- C1 The open and unbuilt upon area within the street front zone must be retained and is to remain visible from the street.
- C2 Traditional landscaped and open areas in the street front zone are to be retained.
- C3 The design of new open space areas in the street front zone must use features and materials that are appropriately scaled and consistent with the architectural character of the building and the group, where the building forms part of a group.
- C4 A dwelling that is a dwelling house, dual occupancy, semi-detached dwelling or an attached dwelling is to provide the following: an unbuilt upon area including a principal open space area to be located at the rear, and deep soil landscaped area in accordance with Table 2.
- C5 A new residential flat building, manor house, multi dwelling housing (terraces) or multi dwelling housing, or the adaptive reuse of a building as a residential flat building, manor house, multi dwelling housing (terraces) or multi dwelling housing is to be provided with private open space, unbuilt upon area and deep soil landscaped area in accordance with Table 3, except where compliance would require demolition of significant structures.
- C6 Each new dwelling within a mixed use development is to be provided with private open space and deep soil landscaped area in accordance with Table 3.
- C7 Deep soil landscaped area must be in a location and have an adequate soil profile depth to allow for root volumes and the long term stability and health of vegetation.
- C8 Appropriate vegetation types are to be planted in the deep soil landscaped areas having regard to the dimensions of the area and the nature of subsurface soil and rock profiles.  
Note: Advice from an arborist/horticulturist is recommended.
- C9 Part of the private open space must be capable of serving as an extension of the dwelling for relaxation, dining, entertainment, recreation and children’s play area and should be directly accessible from the main living area of the dwelling.

- C10 Stairways and ramps may be used to provide access from the building to the open space in cases of sloping sites and grade variations.
- C11 The raising of open space areas to provide level access from a building is not permitted if there would be an adverse impact on adjoining properties and the significance of the property generally.
- C12 Private and communal space is generally not permitted in the form of a roof terrace.

**TABLE 3** Minimum unbuilt upon area and deep soil landscaped area requirements for a dwelling that is: a dwelling house, dual occupancy, semi-detached dwelling or an attached dwelling

Lot size	Minimum unbuilt upon area for each dwelling	Minimum deep soil landscaped area for each dwelling
Up to and including 100m <sup>2</sup>	▶ 10% of site area	5m <sup>2</sup>
More than 100m <sup>2</sup> and less than 180m <sup>2</sup>	<ul style="list-style-type: none"> <li>▶ 16% of site area</li> <li>▶ Principal rear area—minimum area of 15m<sup>2</sup></li> <li>▶ Principal rear area to have a minimum dimension of 3m</li> </ul>	8% of site area
180m <sup>2</sup> and above	<ul style="list-style-type: none"> <li>▶ 18% of site area</li> <li>▶ Principal rear area—minimum area 35m<sup>2</sup></li> <li>▶ Principal rear area to have a minimum dimension of 3m</li> </ul>	12% of site area

Note: The unbuilt upon area includes areas such as the deep soil landscape area, courtyards, unroofed swimming pools or tennis courts and the like. Uncovered parking areas and driveways are not to be calculated as unbuilt upon area.

**TABLE 4** Minimum private open space, unbuilt upon area and deep soil landscaped area requirements for residential flat buildings, manor houses, multi dwelling housing (terraces), multi dwelling housing and mixed use developments

Residential type	Minimum unbuilt upon area	Minimum deep soil landscaped area required	Minimum private open space required for each dwelling
<b>New development</b>			
Residential flat building, manor house, multi dwelling housing (terraces) or multi dwelling housing	40% of site area	20% of site area	(See below for dwellings)
Each new dwelling within the development	N/A	N/A	<ul style="list-style-type: none"> <li>► Minimum area of 8m<sup>2</sup></li> <li>► Minimum dimension of 2m in the form of a courtyard, balcony or verandah</li> </ul>
<b>Adaptive re-use of an existing building</b>			
Adaptive re-use of a building for a residential flat building, manor house, multi dwelling housing (terraces) or multi dwelling housing	N/A	<ul style="list-style-type: none"> <li>► 8% of site area where site less than 180m<sup>2</sup></li> <li>► 12% of site area where site is at least 180m<sup>2</sup></li> </ul>	(See below for dwellings)
Each new dwelling within the development	N/A	N/A	<ul style="list-style-type: none"> <li>► Minimum area of 8m<sup>2</sup></li> <li>► Minimum dimension of 2m in the form of a courtyard, balcony or verandah</li> </ul>
<b>Mixed use development</b>			
Mixed use development	N/A	<ul style="list-style-type: none"> <li>► 8% of site area where site less than 180m<sup>2</sup></li> <li>► 12% of site area where site is at least 180m<sup>2</sup></li> </ul>	(See below for dwellings)
Each new dwelling within the mixed use development	N/A	N/A	<ul style="list-style-type: none"> <li>► Minimum area of 8m<sup>2</sup></li> <li>► Minimum dimension of 2m in the form of a courtyard or verandah</li> </ul>

---

Note: The unbuilt upon area includes areas such as the deep soil landscaped area, courtyards, unroofed swimming pools, or tennis courts located at or near ground level, and the like. Uncovered parking areas and driveways are not to be calculated as unbuilt upon area.

#### *Swimming pools and spa pools*

- C13 Pools are to be located at the rear of properties.
- C14 For corner lots, and where the property has two street or lane frontages, pools are not to be located in the primary frontage (that is, they may be located in the secondary frontage).
- C15 Pools must not have an adverse impact on the fabric of adjoining properties or an adverse impact on the amenity of the occupiers of adjoining properties in terms of noise from pool equipment, flood lighting and discharge of backwash.
- C16 Pools will not be permitted if:
- a) construction of the pool would result in the removal of a tree that is a prescribed tree;  
or
  - b) the deep soil landscaped area requirement cannot be satisfied.
- C17 Pool coping must be flush with or not higher than 300mm above the existing ground level and no portion of the pool casing is to be visible from the public domain or an adjoining property.

#### *Courtyards*

- C18 Courtyards and lightwells must have an adequate system of stormwater drainage to avoid flooding of the property and adjoining properties in the event of one system being blocked, and to provide more efficient drainage when excessive stormwater occurs, such as double systems or long strip drainage.

#### *Landscaping*

- C19 Trees and shrubs at maturity should not have an adverse impact on the fabric of buildings, infrastructure, powerlines or other structures, and have only a minimal adverse impact on the amenity of the occupiers of properties.
- C20 Where prescribed trees are to be retained, structures are setback so they do not impact on the health of the tree.
- C21 Where possible, vegetation should be located to improve privacy between dwellings.
- C22 For infill development, trees are to be selected and located to contribute to energy efficiency and amenity by providing substantial shade in summer, especially to west facing windows, and by admitting sunlight to indoor and outdoor living areas in winter.
- C23 Landscaping must ensure the retention of adequate sight lines for pedestrians and vehicles, especially at street corners.

---

### C1.4.9 Views

---

Paddington’s sloping topography and the orientation of streets and subdivisions combine to offer panoramic and lesser views of the harbour, distant foreshores and city skyline from private properties and public areas. Views from private and public lands also take in the built landscape, including the stepped development pattern of terraces, roofscapes and winding streets.

Public views from streets, footpaths, parks and other public areas are among Paddington’s prized assets and are significant features of the area’s character. Protection of public views allows people to see and interpret the landscape and landmark features.

The height, bulk, form and scale of new developments have the potential to adversely impact on views gained from private and public lands. For private lands, the concept of view sharing is promoted. View sharing controls seek to strike a reasonable balance between new development and access to views from existing development.

Note: Refer to Section 1.6.2 Views and vistas for further information on views from public spaces and a map showing a selection of public views.

#### Objectives

- O1 To minimise the impact of new development on views from existing development.
- O2 To promote the concept of view sharing from private properties as a means of ensuring equitable access to views.
- O3 To protect and enhance views from streets and other public spaces.
- O4 To provide additional views from streets and other public spaces where opportunities arise.

#### Controls

- C1 New development must enable view sharing with surrounding development, particularly from main habitable rooms of that development.
- C2 Views from public open spaces to the harbour, foreshore areas and city skyline are to be preserved.
- C3 Location of new trees should enable views to be framed and protected when the trees reach maturity.



---

### C1.4.10 Acoustic and visual privacy

---

The predominant terrace building style in Paddington has resulted in a dense urban environment. Potential noise sources associated with more people living, working and recreating closer to each other often raises issues relating to acoustic and visual privacy.

Acoustic and visual privacy are major determinants of the ability of residents to enjoy their homes. Issues of acoustic and visual privacy are compounded in Paddington due to the historic mix of land uses, which may find retail, commercial and residential uses existing side by side.

The acoustic and visual privacy needs of residents should influence all aspects of design, including the location of new building works, building scale, the placement of windows, the location of main living rooms in a building, and the type of materials and construction techniques.

Various design solutions are possible for maintaining and improving acoustic and visual privacy. Solutions need to be considered having regard to matters such as the likely impact on heritage significance, the impact on bulk and scale, and the impact on the amenity of adjoining properties, including overshadowing.

Landscaping with vegetation is not considered to be an effective screening measure or a means of maintaining and improving privacy and is not a preferred solution. This is because it cannot be guaranteed that vegetation will be suitably and continually maintained by current and future owners, the long term health of vegetation is dependent on climatic conditions and the absence of disease, future building works can pose a threat to vegetation despite careful design, and effective vegetation screening often has to be of such a size and density which can create issues with proximity to buildings and structures and impact on light to living and recreation areas.

**Note:** An acoustic report prepared by a suitably qualified and experienced professional may be required as part of the site and context analysis process.

#### Objectives

- 01 To ensure an adequate degree of acoustic and visual privacy in building design.
- 02 To minimise the impact of new development on the acoustic and visual privacy of existing development on neighbouring lands.

#### Controls

- C1 Sound attenuation measures such as acoustic glazing and insulation are to be provided for new development close to high noise sources, such as busy roads and the Eastern Suburbs railway line.
- C2 In sensitive locations, such as where commercial, retail or other non-residential buildings adjoin or are adjacent to residential properties, or on busy roads, designs must meet the criteria for the Southern Sydney Regional Organisation of Councils Code for Road, Rail Noise Levels - External Noise Insulation Requirements for Multi Unit Residential Housing Against Road and Rail Noise.

- C3 Windows to bathrooms and toilet areas must have translucent glazing if they have a direct view to and from habitable rooms and private open space on adjoining and adjacent properties.
- C4 Direct overlooking of the main living areas and private open space areas of adjoining and adjacent properties should be minimised by the sensitive location of windows, balconies, and screening devices.
- C5 Rear and side balconies must not impact on:
- a) the privacy and amenity of the building occupants; or
  - b) on the amenity of the occupants of adjoining and adjacent properties.
- C6 Privacy screens are to be designed with regard to the architectural style of the building and relevant aspects of the historic context.
- C7 Privacy screens must minimise view loss from other buildings and not unreasonably impact on solar access to neighbouring properties. (Refer to solar access requirements in Section 1.4.5. Building height, bulk, form and scale).

---

### C1.4.11 Land subdivision and site amalgamations

---

The distinct street pattern of Paddington arose out of the historic stages of the area's development. The earliest development on the western side of Paddington evolved as the Paddington village along cart tracks and is characterised by short angled narrow roads with closed vistas and dogleg junctions influenced by the boundaries of early land grants. Dense rows of cottages and terrace housing often have zero setbacks.

Later street patterns in the eastern half of Paddington were laid out in the Victorian boom period. The subdivisions are more strictly ordered with alternating wide streets and rear lanes (for night soil) and set out in the rectilinear grid. Development on corner sites is usually sensitive to the pivotal position they occupy in both streetscapes.

Generally there are narrow allotments with pairs, groups, and rows of housing which have similar setbacks and alignments. Within the allotments there are typical building footprints. In the commercial area, shops adjoin each other in terrace style arrangements. The buildings are aligned to the footpath edge.

Note:

- i) Woollahra LEP 2014 sets the minimum lot size for subdividing land.
- ii) Where a proposal for subdivision or site amalgamation involves the creation of a new lot or a number of lots and that lot or lots are capable of accommodating new buildings, the development application should be accompanied by at least a conceptual plan of the new buildings.

#### Objectives

- O1 To retain existing subdivision and building patterns.
- O2 To retain public lanes and public passageways which service Paddington's pedestrian network.
- O3 To ensure that subdivision or amalgamation of sites provides an appropriate response to the relevant historic character of Paddington and the relevant aspects of its historical pattern of development.

#### Controls

- C1 A proposed subdivision of an existing lot to create a new lot or an amalgamation of a number of lots must be of a size in area and dimensions which reflects the characteristics of historically relevant allotments adjoining and in the vicinity of the site.
- C2 Subdivision or site amalgamation must not compromise:
  - a) the significant features of the existing building on the site including outbuildings;
  - b) the setting of the existing site including significant fences and landscape elements; or
  - c) the setting of the building on adjoining sites.
- C3 Public lanes and public pedestrian passageways are not to be amalgamated with private land.

---

## C1.5 Specific policy for building and site elements

This section contains specific controls for building and site elements on residential and non-residential buildings, as relevant. The objectives and controls in this section apply to alterations and additions to existing buildings, and when constructing a new building.

The building and site elements addressed in this section are:

- ▶ 1.5.1 Dormers and skylights
- ▶ 1.5.2 Chimneys
- ▶ 1.5.3 Windows, doors, shutters and security
- ▶ 1.5.4 Verandahs and balconies
- ▶ 1.5.5 Fences, walls and gates
- ▶ 1.5.6 Onsite vehicle parking, garages, carports, driveway access and servicing facilities
- ▶ 1.5.7 Lofts over garages
- ▶ 1.5.8 Materials, finishes and details
- ▶ 1.5.9 Exterior colours
- ▶ 1.5.10 Gardens and trees
- ▶ 1.5.11 Satellite dishes, aerials and site facilities

The controls in this section are to be read in conjunction with the controls in:

- ▶ Section C1.3 Building type; and
- ▶ Section C1.4 General controls for all development.

### C1.5.1 Dormers and skylights

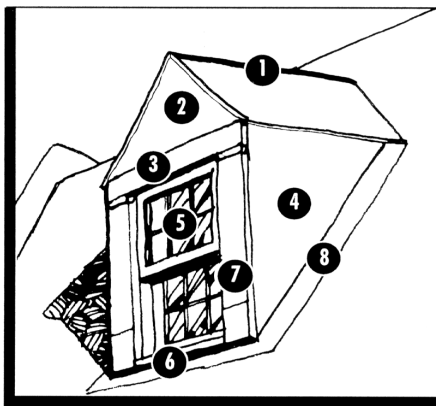
Adaptation of the roof void areas of the principal building forms of Victorian and Federation period dwellings was a traditional building method to increase the area available for bedrooms. Typically light and ventilation was provided to these attic level rooms by constructing a dormer window located vertically within the principal roof planes.

Notwithstanding, more numerous are the houses which exist without dormers to the street front elevations. Dormers to the street front significantly alter the character of the streetscape. Skylights located in highly visible positions, large skylights and skylights with protruding profiles can also detract from Paddington's roofscape.

Current pressures for accommodation make the use of the roof space desirable. Where the principal roof form has sufficient slope and height an attic room may be possible with a dormer in the rear slope of the principal roof form.

Using the roof space is possible if the original ceilings are retained, except where interrupted by a new stair or ladder access. To maintain the consistency of new dormers, traditional models for Victorian and Federation period buildings, with specific proportions and dimensions, are provided in this section.

**FIGURE 12** Dormer - typical elements



- 1 Dormer roof
- 2 Pediment
- 3 Lintel
- 4 Cheek
- 5 Double hung window
- 6 Sill
- 7 Pilaster
- 8 Flashing

#### Objectives

- O1 To minimise the impact of dormers and skylights on the form, appearance and fabric of the principal roof form.
- O2 To ensure that dormers to Victorian and Federation period terraces and cottages are traditional in form, proportions, scale and materials.
- O3 To ensure that new attic spaces do not unnecessarily impact on original significant fabric, especially original ceilings.

## Controls

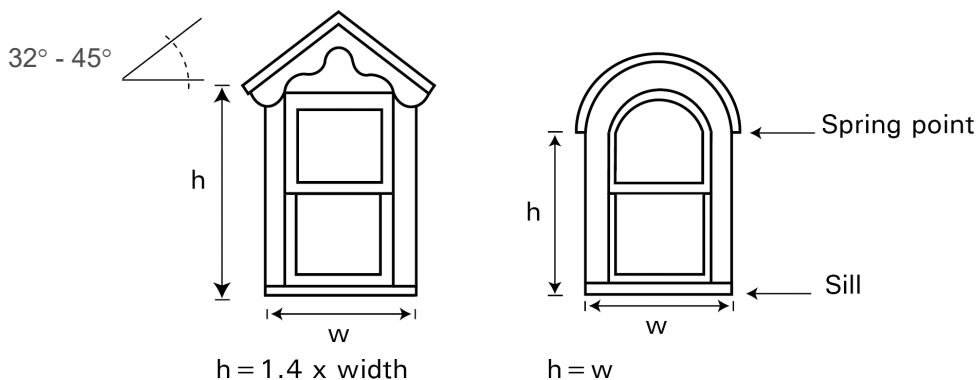
### *Dormers - general*

- C1 Dormers must not be added to street front and side elevations of the principal form of contributory buildings unless documentary evidence sufficiently shows that an original dormer or dormers existed in these locations as part of the original design. In these instances the design of the reconstructed dormer window is to conform to the documentary evidence.
- C2 Attic spaces in a Victorian or Federation period building that contributes to the significance of Paddington may be permitted if the original ceiling to the principal form remains intact except for the provision of a stair or access ladder.
- C3 A dormer may be located within the rear slope of the principal roof form only if this would have no impact or negligible impact on:
- a) the architectural integrity and style of the main roof form;
  - b) the building's significance;
  - c) the group's significance, where the building forms part of a group; and
  - d) the significance of the heritage conservation area.
- C4 More than one dormer may be located within the rear slope of the principal roof form subject to:
- a) the width of the roof being greater than 6m;
  - b) each dormer being identical in type, size and no greater than 1.2m maximum width overall; and
  - c) consideration of the impact on the building's significance, on the group's significance where the building forms part of a group, and on the streetscape.
- C5 The design, proportions and materials of new dormers, where permitted, must be based on traditional models and must be appropriate to the architectural style of the building and the building's context (see Figures 13 and 14).
- C6 Dormers must be arranged symmetrically on the roof plane.
- C7 Dormers must not incorporate balconies, balconets or Juliet balconies.
- C8 Pediment infill and side cheeks to traditional and contemporary dormers must not be glazed.
- C9 Pediments may be infilled with flush fitting timber ventilators.

*Dormers to Victorian period cottages, semi-detached dwellings and terraces*

- C10 For buildings 4m wide or wider, a dormer, or each dormer where more than one is possible due to roof width, must not exceed 1.2m in width.
- C11 Where buildings are less than 4m wide, a single dormer must not exceed one third of the width of the roof or 1m overall, whichever is the lesser.
- C12 For a dormer with a pitched roof:
- the height of a window is to be 1.4 times its width, as measured from the head of the window to the bottom of the sill; and
  - the roof pitch is to be between 32° and 45°.
- C13 For a round headed dormer, the height of a window measured from the bottom of the sill to the springing point of the rounded head is to be equal to the overall width of the dormer.
- C14 The top of a dormer must be below the main roof ridge by at least 300mm.
- C15 The top of the dormer window sill must be set at least 400mm above the finished floor level.
- C16 The roof of the dormer must be clad with corrugated metal sheeting and flashing that matches the existing roof colour. The roof sheeting and bargeboard must not exceed a 150mm overhang. Dormers must have a timber pilaster facing and no wall cladding below the sill. Cheeks must be clad in timber weatherboards.
- C17 Where dormers are reconstructed on street front elevations (as allowed under C1), they must use traditional windows appropriate to the building style. Documentary evidence must be provided to support the appropriateness of the window type.

**FIGURE 13** Traditional 'Victorian' period dormers

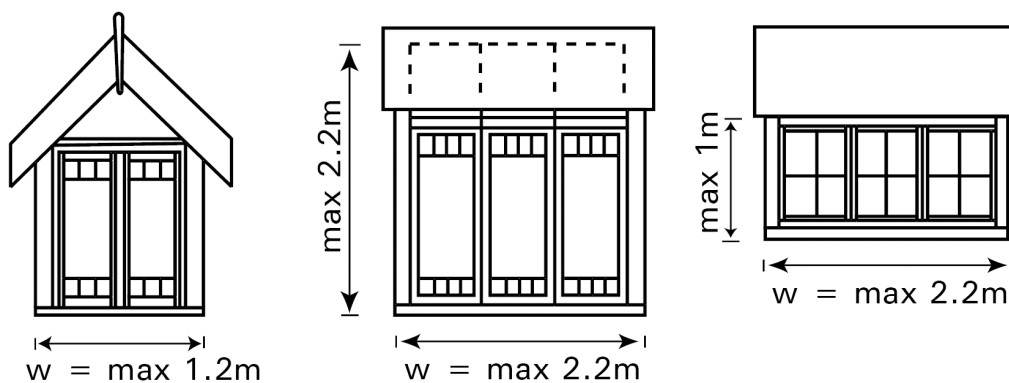


*Dormers to Federation period cottages, semi-detached dwellings and terraces*

- C18 Dormers to Federation period contributory buildings should be appropriate to the architectural style of the building.

- C19 Vertically proportioned Victorian period dormers with double hung or casement windows are permitted if they comply with the proportions and location of C10 or C11, and C12 to C15.
- C20 Horizontally proportioned dormers with casement windows are permitted with eyelid or hipped roof forms if:
- designed appropriately to the building's type;
  - the top of the dormer is located at least 600mm below the main roof ridge line;
  - the top of the sill is set at least 900mm above the gutter line;
  - the dormer width is limited to 2.2m;
  - the window height is limited to 1m maximum or 2.2m maximum depending on the window type (see Figure 14); and
  - the dormer complies with Figure 14.

**FIGURE 14** Federation period dormers



*Dormers to infill buildings*

- C21 A contemporary styled dormer may be located within the rear roof plane of the principal roof form of an infill building where:
- there would be no impact or negligible impact on the heritage significance of the adjoining buildings and on the significance of the heritage conservation area;
  - the proportions comply with C10 or C11, and C12 to C15; and
  - the provisions of C6, C7, C8 and C9 are met.
- C22 More than one dormer may be located within the rear slope of the principal roof form subject to:
- the width of the roof being greater than 6m;
  - each dormer being identical in type, size and no greater than 1200mm maximum width overall;



- c) the height of each dormer complying with C12 to C15;
- d) the provisions of C6, C7, C8 and C9 being met; and
- e) consideration of the impact on the significance of the adjoining properties and on the streetscape.

### *Skylights*

- C23 Skylights are not to be placed in front or side facing roofs of the principal roof form.
- C24 A single skylight may be placed in the rear facing slope of the principal roof form by itself, or with a single dormer.
- C25 A maximum of two skylights may be placed in the rear facing slope of the principal roof form provided:
- a) they are arranged symmetrically; and
  - b) there is no dormer.
- C26 Two skylights may only be placed non-symmetrically where it can be demonstrated that their location is essential to internal amenity.
- C27 No skylights may be placed in the rear facing slope of the principal roof form where there are two or more dormers.
- C28 Skylights must be of a low profile and should be flush with the roof surface. They should have simple, unobtrusive detailing and be non-reflective. Colouring must merge with the roofing material.
- C29 A skylight on the principal roof form is to not to exceed an area greater than 1.5m<sup>2</sup>.
- C30 Rear roof planes are not to incorporate more than 25% transparent material. This includes the area of skylights and dormer windows.

## C1.5.2 Chimneys

---

Chimneys are important elements within the heritage conservation area. They add vertical emphasis to the roofscape and richness by the variety of forms and detail.

### **Objectives**

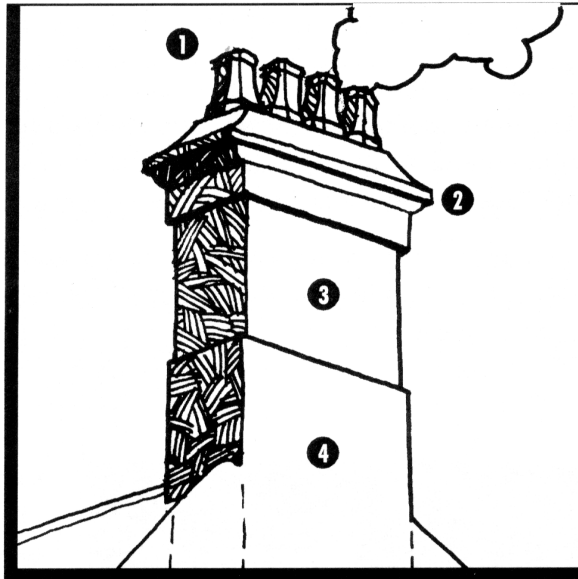
- O1 To retain and conserve original chimneys and their details.
- O2 To encourage reinstatement of missing chimney elements.

### **Controls**

- C1 Original chimneys and their details must be retained.

- C2 When works are proposed to the roof of the principal form of the building, missing details from existing chimneys, where substantiated by evidence, are to be reinstated and repairs to existing chimneys are to be undertaken in a traditional manner.

**FIGURE 15** Typical chimney stack



- 1 Chimney pot
- 2 Coped and moulded cornice
- 3 Shaft
- 4 Stump

### C1.5.3 Windows, doors, shutters and security

The majority of window types available in the late 19th and early 20th century were double hung timber framed sashes. Windows were commonly rectangular in shape and vertically proportioned. Where a larger opening was desired, windows were set in groups. Rear windows were vertically proportioned and relatively plain.

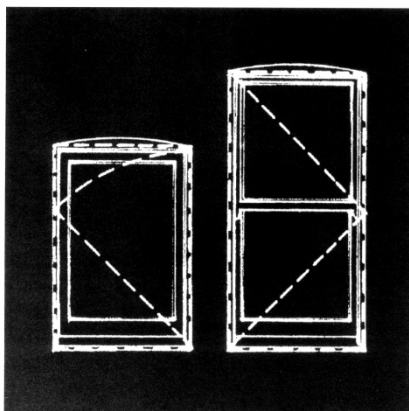
Casement windows became fashionable in the early 20th century. Often these were grouped in threes. Glazing bars, glazing and the number of panes reflected stylistic fashions and advances in the manufacture of the size of sheets of glass. Both casements and double hung windows were sometimes embellished with coloured and patterned glass. This decorative treatment is usually located on the street front location. Rear glazing is comparatively plain.

The front door was the most elaborately detailed timber door of the house. Commonly it featured moulded and recessed panels and good quality hardware. The quality and level of detail diminished in secondary areas of the house. Doors to verandahs at the first floor level were usually timber French doors with solid lower panels.

Louvered timber shutters were commonly used for windows and doors to assist with cooling buildings and providing privacy and security. In two storied or higher buildings, shutters might only have been fitted to the ground floor windows and French doors.

Security devices which conceal the windows and doors to the street front elevations of a building adversely affect the visual character of the building.

**FIGURE 16** New windows



**Window 1**

**Window 2**

Traditional vertical proportions of fenestration should be maintained. New windows should be vertical in proportion, preferably within the range suggested. The width of a window should not be greater than the height given by the radius of the diagonal, as shown on **Window 1**. The height of the window should not exceed twice the width, as shown in **Window 2**.

These controls are applicable for new windows in existing walls and additions to existing buildings. Greater freedom of interpretation is permitted for infill development.

## Objectives

- O1 To retain and conserve original windows, and doors and their associated detailing and joinery components including original shutters on significant elevations of the principal building form, such as street fronts and side elevations facing streets.
- O2 To reinstate traditional windows, doors, and shutters consistent with the architectural style of the building on significant elevations facing streets.
- O3 To retain the visual prominence of windows and door openings visible from the public domain.

## Controls

### *Windows and doors*

- C1 Original windows, doors and shutters on the elevations of the principal building form and side elevations facing the street are to be retained.
- C2 When works are proposed to the street front elevations on the principal building form and on side elevations facing the street, unsympathetic windows and doors on those elevations are to be removed and replaced with windows and doors that are consistent with traditional elements of known earlier configuration in terms of size, proportion, materials and detail.
- C3 Traditional shutters to windows and French doors should be reinstated where they have been known to exist previously where visible from the public domain.
- C4 New doors and window openings must be consistent with traditional materials and patterns, use vertically proportioned openings appropriate to the building type and comply with Section 1.4.3 Rear elevations, rear additions, significant outbuildings and yards.
- C5 Where rear wings are extended boundary to boundary at the ground floor, new doors and windows must be vertically proportioned, but may use contemporary detailing.
- C6 New doors replacing a rear window opening at the upper level of a rear wing are to be limited to the size of a set of traditional French doors.

### *Security*

- C7 Security should be provided by the least obtrusive method such as the use of mortice deadlocks, window and door locks, an alarm system or internal security bars, internal timber window shutters or security film attached to the internal face of glazing, and other measures in preference to external security grilles.
- C8 External metal security doors and window grilles are permitted where they use simple, unembellished, rectangular bars in a vertical pattern or a pattern that reflects the configuration of the glazing bars, and are painted in recessive colours that match the colour of the door or window frame.

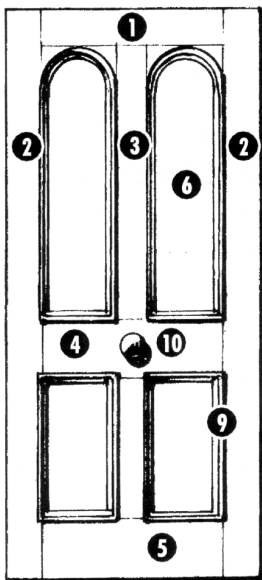
- C9 Highly visible grilles embellished with pseudo period detail over windows and doors are not permitted.
- C10 Roller shutters will not be permitted to windows or doors.
- C11 Motorised window sunscreens are permitted only to ground floor windows not visible from the public domain.

### Door types

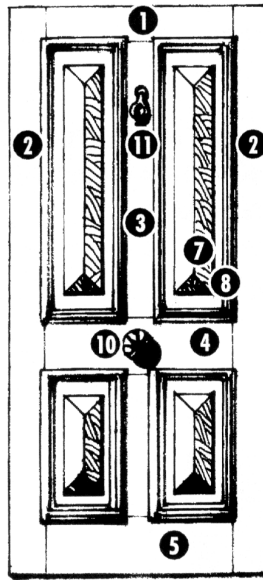
Some common examples of front doors are shown. All are panelled doors with stiles and rails. Type A and Type B are four panel doors, while Type C is a high-waisted Edwardian door.

**FIGURE 17** Door types

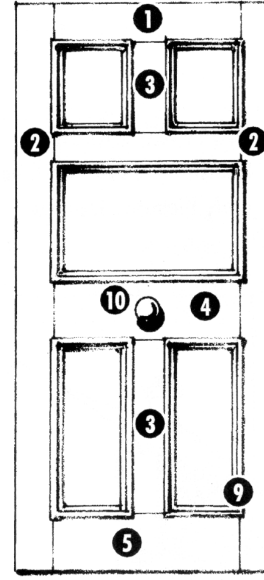
**Type A – Mid Victorian**



**Type B – Late Victorian**



**Type C – Edwardian**



Some common examples of front doors are shown. All are panelled doors with stiles and rails. Type A and Type B are four panel doors, while Type C is a high-waisted Edwardian door.

- 1 Top rail
- 2 Stile
- 3 Muntin
- 4 Mid rail
- 5 Bottom rail
- 6 Sunken panel
- 7 Raised field panel
- 8 Bolection mould
- 9 Lamb's tongue mould
- 10 Knob
- 11 Knocker

### C1.5.4 Verandahs and balconies

Many buildings obtain their visual interest from verandahs and balconies, which create a strong pattern of light and shade by their projection, decorative timber or cast iron and the covering balcony roof. Verandahs that are traditionally located on the front elevation are an important element in the streetscape and should be conserved.

Note: Balconies associated with dormers are not permitted, as addressed in Section 1.5.1 Dormers and skylights.

**FIGURE 18** Verandahs and balconies



- 1 Ogee gutter
- 2 Timber mouldings
- 3 Cast iron lace frieze
- 4 Handrail
- 5 Cast iron lace balustrade panel
- 6 Balcony timber floor
- 7 Bead moulding
- 8 Dentils
- 9 Stop-chamfered verandah beam
- 10 Cast iron frieze panel
- 11 Stop-chamfered frieze
- 12 Cast iron lace frieze
- 13 Cast iron bracket
- 14 Fin wall

**FIGURE 19** Types of balconies

**Suspended balcony**

Usually present on Georgian or early Victorian terraces and restored



**Balcony between fin walls**

Typical for mid or late Victorian and Edwardian terraces



**Enclosed balconies**

Enclosed balconies are intrusive and they should be re-opened



---

## Objectives

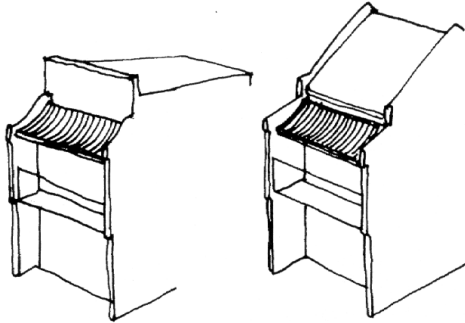
- O1 To retain and conserve original verandahs and balconies and their associated detailing and components.
- O2 To encourage the reinstatement of traditional open balconies and verandahs where verandahs and balconies have been altered or removed.
- O3 To promote sympathetic contemporary design of new rear balconies and verandahs that responds to the historic character of the area.

## Controls

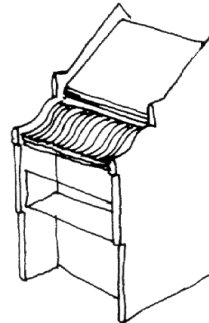
- C1 Original verandahs and balconies are not to be altered except for the reinstatement of original detail, and the reversal of unsympathetic alterations. Patterns of replacement cast iron should be based on physical or documentary evidence of original cast iron elements on the building or in the group.
- C2 Verandahs and balconies may be reinstated where they have been known to exist at an earlier date. The design must be consistent with the architectural style, materials and detailing of the building and the group, where the building is part of a group.
- C3 The step down from the main roof to the balcony roof must be retained or reinstated where a new or replacement balcony or reinstatement of a balcony is proposed.
- C4 The heights of original balustrade panels and rails must conform to the heights of original and appropriate balustrades within Paddington. Balustrade heights may only be increased by inserting a fine horizontal bar above the existing balustrade, supported behind the existing balustrade.
- C5 New verandahs and balconies are not permitted at the upper levels if the building is part of an unaltered group of buildings.
- C6 If the building is part of an altered group of buildings, a rear balcony is permitted where:
  - a) the original rear window opening is widened to a maximum of 1.2m to accommodate a pair of traditionally scaled French doors;
  - b) the balcony width does not exceed the width of the door opening by more than 300mm and must not have a depth greater than 600mm;
  - c) the balcony is a similar form to a traditional balcony, but is detailed in a contemporary manner; and
  - d) a glass balustrade is not used.
- C7 New rear upper floor balconies and verandahs must be designed with regard to the amenity of adjoining and adjacent properties. Privacy screens may be required to reduce the impact of new balconies.
- C8 Verandahs and balconies on infill buildings must be of a contemporary design and materials that demonstrate an appropriate response to the relevant aspects of the historic context.

**FIGURE 20** Balcony roofs

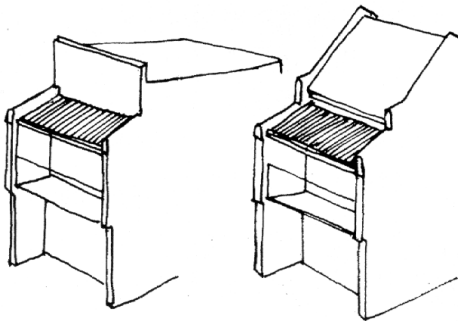
**Concave balcony roof**  
Convex was also common



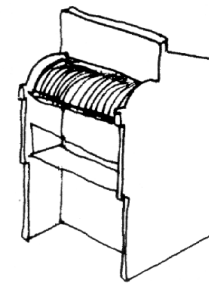
**Ogee balcony roof**  
This form is often reversed



**Skillion balcony roof**  
This form is rare on late Victorian terraces

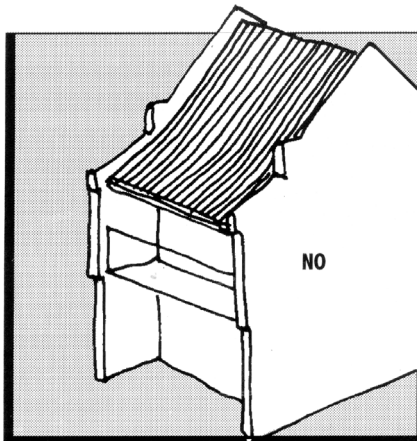


**Bullnosed balcony roof**  
This form is common on late Victorian terraces



**FIGURE 21** Intrusive balcony roof

In the 50s and 60s many terraces were re-roofed, mainly using terracotta or concrete tiles, removing the separation between the roof and the main balcony roof. Renovators are encouraged to reverse this intrusive trend.





---

### C1.5.5 Fences, walls and gates

---

In Paddington, the majority of houses with a setback from the street originally had a front fence. As well as performing the usual range of functions the fence presented the household to the street. Through pickets and iron palisade fences the passer-by could obtain glimpses of gardens and the house.

Each architectural period or building type had an associated style of fence, so the materials and the design of the front fencing varied. Typical Victorian terraces had an iron palisade fence on a sandstone base. Cottages often had a timber picket fence.

Front fences enriched the visual appeal to the street. Side and rear fences were usually rough sawn timber palings or brick and performed a utilitarian function.

Fences play an important role in forming the character of a house. A well designed fence will complement and enhance the qualities of a building. Too often the appeal of a house will be considerably diminished by a fence of inappropriate design and materials. The blank masonry fence on the street front elevation is an example of an unsympathetic fencing type.

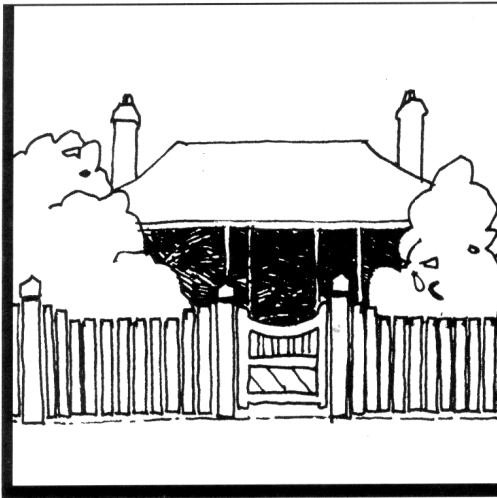
Where groups of buildings were elevated, a boundary wall was constructed using local sandstone, with a traditional fence on top. Often these changes in level occurred beside old quarry sites. Where these street walls are high, they form significant townscape elements.

Note: For garage doors and associated gates refer also to Section 1.5.6 On-site vehicle parking, garages, carports, driveway access and servicing facilities.

#### Objectives

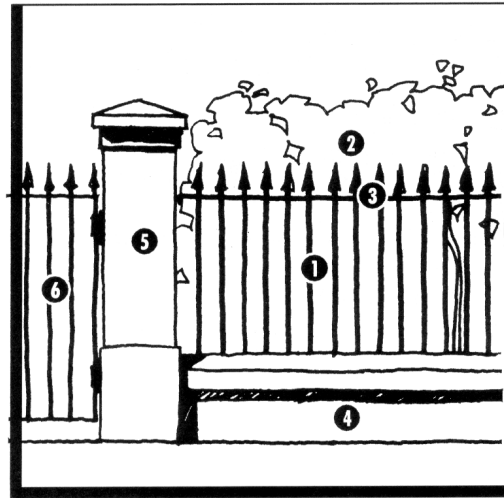
- 01 To retain and conserve original fences and gates.
- 02 To reinstate traditional fences and gates on street frontages and side streets of an appropriate architectural style to existing buildings.
- 03 To maintain traditional heights of fences and their elements.
- 04 To ensure fences and gates for infill development respond in a contemporary manner to the relevant aspects of the historic context.
- 05 To retain views towards the rear of properties from the laneways or over side fences.
- 06 To ensure fences are built with regard to the topography of sloping sites.
- 07 To ensure boundary fences between allotments provide visual privacy without adversely affecting the amenity of adjoining properties in terms of views and sunlight.
- 08 To retain and conserve significant sandstone walls.

**FIGURE 22** Picket fences



Early Colonial and Edwardian buildings are associated with timber picket fences. Picket designs varied from Colonial times through to Edwardian times from small rounded tops, to scalloped, spear-ended and flat tops.

**FIGURE 23** Palisade fence



Detailing of iron palisade fences varied from Colonial to early 20th century times.

- 1 Iron palisade bar
- 2 Iron spearhead top
- 3 Top rail
- 4 Coped masonry plinth
- 5 Masonry pier
- 6 Iron gate

## Controls

### *General - all areas*

- C1 Fences and gates must be constructed to the boundary or, where the adjoining owner's consent has been obtained, on the boundary (except for public land where no encroachment must occur).
- C2 Gates must not encroach over or onto public land when opening and closing.
- C3 Gates must be constructed in line with fences.
- C4 The configuration, finishes and details of original sandstone walls must be retained and conserved. Alterations for the purpose of maintenance, reinstatement or reinstatement of missing elements may occur.

*Street front zone*

- C5 There is to be no alteration to original fences and gates, except for maintenance, reconstruction or the reinstatement of missing elements.
- C6 Unsympathetic fences, walls and gates must be removed and replaced by fences, walls and gates that are of the form, height, details, materials, finishes and quality appropriate to the architectural character of the building and group, where the building forms part of a group.
- C7 New and replacement fences and gates must be consistent with the architectural style of the building and be an appropriate traditional height. If part of a group, a fence must match the original fence in the group.
- C8 In the street front zone, traditional types of fencing permitted for Victorian or Federation buildings comprise one or a combination of the following:
- a) iron or steel palisades on sandstone or rendered bases;
  - v) timber pickets; and
  - w) low brick fences (for Federation type buildings).
- C9 The configuration, finishes and details of original sandstone retaining walls located in the street front zone are to be retained and conserved.
- C10 Breaching an original sandstone retaining wall to incorporate an opening for parking is not permitted.
- C11 New or replacement fences must incorporate root barriers at the street front boundary where street trees occur.
- C12 On corner sites, new fences and gates must allow good visibility for pedestrian and vehicular traffic. This may be achieved by low fences and gates or designs with at least 50% transparency.
- C13 Fences and gates on infill sites should be a contemporary design and of a form, height, detail, finish and materials that demonstrate an appropriate response to the physical and historical context of the streetscape.

**FIGURE 24** Palisade fence in the streetscape



Palisade fences were common for Victorian terraces

**FIGURE 25** Boundary masonry fence



Contemporary high masonry walls as front fences are intrusive in the streetscape and they are not permitted

*Side boundary*

- C14 Side boundary fencing must be consistent with traditional fence, forms and materials.
- C15 The height of side boundary fencing is not to exceed 1.8m.
- C16 On sloping sites, the height of side boundary fences may be averaged and fences may be regularly stepped.

*Rear boundary and side street*

- C17 New fences and gates to side and rear streets and rear lanes are to be of a design and height, and are to use materials and details, which are consistent with the building's context and with the controls contained in Table 4 and in Section 1.5.8 Materials, finishes and details.

**TABLE 5** Rear boundary and side street fence and gate controls

	Scale	Materials
<b>Fences</b>	<ul style="list-style-type: none"> <li>▶ Side street fence maximum height of 1800mm, unless building is designed to face both front and side streets.</li> <li>▶ Side street fence where building is designed to face both front and side, maximum height consistent with architectural style of building and appropriate traditional height.</li> <li>▶ Rear fence maximum height 1800mm.</li> </ul>	<ul style="list-style-type: none"> <li>▶ Rear and side fences should be timber palings.</li> <li>▶ Fully transparent or semi-transparent materials such as lattice are not permitted.</li> <li>▶ Palisade fences to side streets may be permitted where the building is designed to face both front and side streets.</li> <li>▶ Bagged or rendered brick walls may be permitted if appropriate to the context.</li> </ul>
<b>Rear street or laneway gates</b>	<ul style="list-style-type: none"> <li>▶ Maximum gate height 1800mm.</li> <li>▶ Maximum gate width 1200mm.</li> <li>▶ Minimum gate width 900mm.</li> <li>▶ Maximum double gates width 2400mm.</li> </ul>	<ul style="list-style-type: none"> <li>▶ Lugged and braced timber gates.</li> <li>▶ Timber painted bi-fold gates.</li> </ul>
<b>Side street gates</b>	<ul style="list-style-type: none"> <li>▶ Maximum gate height 1800mm, unless lower height required to match fence height for building designed to face both front and side streets.</li> <li>▶ Maximum gate width 1200mm.</li> <li>▶ Double gates maximum width 2400mm.</li> <li>▶ Minimum gate width for pedestrian gates 900mm.</li> </ul>	<ul style="list-style-type: none"> <li>▶ Materials to relate to context.</li> <li>▶ Palisade style gate where palisade fence used.</li> </ul>

---

### C1.5.6 On-site vehicle parking, garages, carports, driveway access and servicing facilities

---

Garages, carports and onsite parking areas for motor vehicles were not elements incorporated into Victorian buildings and their sites. Garages emerged as a building structure with the advent of the motor vehicle just prior to World War I. By the 1930s garages were proliferating and being constructed on the street frontages and rear lanes. Garages were generally of a size allowing single car access only and were treated as secondary or utilitarian buildings with little embellishment. During the late 1960s, double garage doors and roller shutters and carports became common. Two car families and the desire for vehicle security have created pressure for large garages and car spaces within sites in Paddington.

The rear lanes of Paddington are now often lined with garage doors and brick walls. They form an impenetrable and unattractive barrier between private gardens and the public spaces, and have an adverse effect on the character and use of laneways. Their height and mass prevent views towards the rear of buildings, whose forms contribute to the character of the lane. There is an alienation of the pedestrian in these spaces. High solid walls and fences on the rear boundaries can also provide opportunities to screen burglars. This section of the DCP aims to readdress the treatment of these forms.

The demands for car spaces have resulted in a reduction of landscaped area and useable open space to the rear of properties. Consequently, there has been a reduction in trees and a loss of permeable surface, which is increasing the pressure on surface drainage systems. Additionally sandstone kerbing, which forms part of the laneway character, has been removed to provide driveway crossovers.

The pressure for parking has also resulted in proposals for alternate means of providing onsite parking. One alternative involves the use of car stackers. There may be certain circumstances where a stacker arrangement may be acceptable due to the existing site and context characteristics and the scale and form of an existing building. However, generally car stackers are not acceptable in Paddington. Stackers require a substantial surge in electrical power to operate and are therefore environmentally unacceptable, lead to vehicles queuing in laneways and streets due to delays in operating the stacker system which can cause impacts on traffic and pedestrian movements, generally require out of scale garage structures to accommodate the stackers, and involve excessive excavation for basement stackers.

#### Objectives

- 01 To conserve original elements and structures on street frontages and laneway boundaries, including coach houses, stables and rear lane toilets.
  - 02 To ensure that contributory buildings rather than vehicular access and parking structures remain the dominant element in the streetscape.
  - 03 To improve the character of laneways where unsympathetic earlier development such as high brick walls and full width garages has eroded the quality of these urban spaces.
  - 04 To ensure that the designs of garages, carports, fences and gates are sympathetic in their massing, form and scale to the relevant aspects of the historic context and setting of the building and allow visual connectivity to the principal building form of a significant group.
-

- 
- O5 To encourage development that is scaled for the pedestrian in terms of height, articulation and modulation.
  - O6 To provide off street car parking and servicing facilities where feasible.
  - O7 To retain sandstone kerbing on streets and laneways where feasible.
  - O8 To ensure that the amount and quality of deep soil landscaped area and private open space are not compromised by providing on-site parking and servicing areas.
  - O9 To minimise vehicle and pedestrian conflicts.
  - O10 To ensure there is no net loss of vehicle parking spaces in the area.
  - O11 To ensure that use and quantity of on street parking spaces is not adversely affected.
  - O12 To prevent vehicle car stackers.
  - O13 To minimise overshadowing, loss of privacy and the impact of building bulk on adjoining properties.
  - O14 To minimise excavation.

## Controls

### *General*

- C1 Onsite parking areas, parking structures and servicing areas such as loading facilities are not a mandatory requirement. In addition, and subject to circumstances listed in the following controls, on-site parking will only be permitted or may only be required where:
    - a) the parking area, servicing area or structure will not have a detrimental impact on:
      - the amenity of adjoining properties;
      - the architectural character or significance of a building, including original coach houses, stables or rear lane toilets (where the toilets occur on adjoining properties);
      - the character of a streetscape or laneway; or
      - the health of a significant tree;
    - b) vehicle entries and exits will not have a detrimental impact on pedestrian movements, traffic movements, Council infrastructure or service authority infrastructure;
    - c) the parking area, servicing area or structure will comply with the current Australian Standard 2890.1-2004;
    - d) a driveway will comply with AS 2890.1 - 2004;
    - e) extensive excavation is not required and the excavation controls in Section 1.4.7 are met;
    - f) private open space and deep soil landscaped area controls are met;
    - g) there are adequate sight distances to allow safe vehicle movement into and from the site;
-

- h) there is no net loss of vehicle parking spaces in the immediate area; and
  - i) the use and quantity of on-street parking spaces is not adversely affected.
- C2 No further vehicle crossings are permitted at street frontages that form part of the street front zone.
- C3 No parking is permitted on that area of the site which forms part of the street front zone or within or beneath the principal building form.
- C4 Vertical car stackers are not permitted.
- C5 The design and location of car parking spaces and structures must allow an 85th percentile vehicle to manoeuvre into and out of a space without the loss of on-street parking opposite or abutting the proposed vehicle entry. This is particularly relevant where the street or lane is less than 5m between kerbs.
- Note: Vehicle turning paths are to be determined in accordance with Australian Standard 2890.1.2004. The 85th percentile vehicle is a standardised vehicle based on the significant characteristics of various vehicle types operating on Australian roads. More information about the 85th percentile vehicle, including its dimensions, can be found in AS 2890.1.2004.
- C6 Garages and carports must comply with the dimensions, settings, forms and materials shown in Tables 5 and 6.

*Street front zone*

- C7 A single uncovered car space, single carport or single garage, may be permitted if:
- a) an approved vehicle crossing exists on the street frontage;
  - x) the existing building is setback from the side boundary which adjoins another building by a minimum of 3m in the case of a proposed uncovered car space or carport, and a greater distance in the case of a proposed garage;
  - y) the car space, carport or garage is setback behind the outer front wall of a building in the street front zone, excluding any projecting balconies or decks; and
  - z) the general controls C1-C6 can be met.
- C8 Where parking is permitted under C7, new garage and carport structures are to be of a design and in materials that respond to the relevant aspects of the historic context. An appropriate contemporary design is permitted and should not be an historic imitation.

*Rear lane or rear street*

- C9 Rear lane or rear street vehicle access and associated on-site parking are permitted if:
- a) the distance from the rear of the building, whether existing or proposed, to the rear boundary is 10m or more;
  - aa) the block width is 3.4m or more;



- 
- bb) the lane or street width between kerbs is 4.8m or more, but if less the applicant can demonstrate to Council that access can be achieved by compliance with C6 and C1(d); and
- cc) the general controls of C1-C6 can be met.
- C10 Where rear lane or street parking is permitted under C9, and the property is 4.7m or more in width, proposals must provide an acceptable interface between the private and public domain by incorporating elements such as pedestrian gates or fencing a minimum of 1200mm wide along rear boundaries. Where possible, gateways on adjoining properties should be grouped.
- C11 Where rear lane or street parking is permitted under C9, double garages, double carports, double car spaces are permitted only where the property is a least 7.1m wide and a 1.2m wide gateway is provided. Structures must not exceed a width of 6m.
- C12 Any loss of on-street parking due to construction of a new driveway access must be compensated by an equivalent number, or more, of onsite parking spaces.
- C13 Laneway garages with roof landscaping are permitted only where:
- a) the property slopes steeply to the rear;
  - dd) the floor level of the roof landscaping is below the floor level of the existing lowest floor of the principal building form;
  - ee) the roof is non-trafficable except for garden maintenance purposes;
  - ff) there is compliance with the deep soil landscaped area requirement; and
  - gg) the roof landscaping area, including planter boxes, parapets and landscaping will not adversely impact on adjoining and adjacent properties.

#### *Residential parking rates*

- C14 For residential parking requirements refer to Chapter E1 Parking and Access.
- C15 Onsite parking must comply with the provisions of C1-C13. Maximum parking may not be permitted where non-compliance with the provisions of C1-C13 will occur.

#### *Retail, commercial and other non-residential parking and servicing rates*

- C16 For retail, commercial and other non-residential development, the average number of onsite parking spaces and servicing facilities must comply with the controls in Chapter E1 Parking and Access.
- C17 Onsite parking and servicing facilities must comply with the provisions of C1-C13. Maximum parking may not be permitted where non-compliance with the provisions of C1-C13 will occur.

**TABLE 6** Dimensions for garages and carports

Rear lane, rear street and existing street-front access locations (unless otherwise specified)

Garage carport type		Width	Height		Door			Piers	
		Max	Max to top parapet <sup>1</sup>	Max wall height below eave	Height	Max width	Min width <sup>2</sup>	Min width	Max width
Garage - flat roof parapet form <sup>3</sup>	Single space	4340	2800	2800	2200	3400	2400	350	470
	Double space	6000	2800	2800	2200	5000	N/A	470	600
Garage - pitched roof form <sup>4</sup>	Single space	4340	N/A	2700	2200	3400	2400	350	470
Garage - with garden roof <sup>5</sup>	Single space	4340	3000	3000	2200	3400	2400	350	470
	Double space	6000	3000	3000	2200	5000	N/A	470	600
Carport - flat roof form <sup>3</sup>	Single space	4340	N/A	2700 <sup>6</sup>	2200	3400	2400	350	470
	Double space	6000	N/A	2700 <sup>6</sup>	2200	5000	N/A	470	600
Carport - pitched roof form <sup>3</sup>	Single space	4340	N/A	2700 <sup>6</sup>	2200	3400	2400	350	470

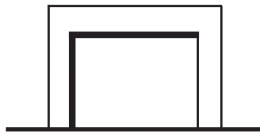
Notes:

All dimensions in millimetres

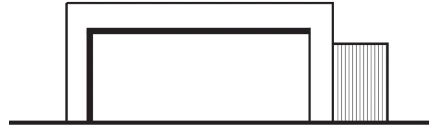
1. Top of parapet from lane or street level
2. Doorway width will vary depending on road/lane width. Refer to C5 in Section 1.5.6. The minimum acceptable doorway width is 2400mm.
3. Double space garage and carport (adjoining or tandem) not permissible in front yard
4. Pitched roof form only permitted for single space garage and single space carport
5. Landscaped roof form only permitted in rear lane and rear street
6. Column or pier height for carport

**FIGURE 26** Garage and carport design diagrams

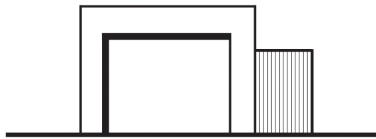
Laneway garage



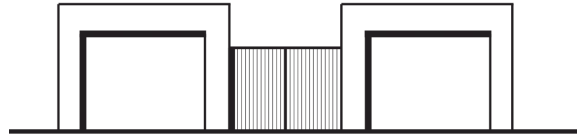
Laneway double garage – with side gate/fence



Laneway garage – with side gate/fence



Grouped garages – with side gates/fences



Laneway garage – with gabled roof form



Laneway garage – with roof garden



**TABLE 7** Setting, form and materials for garages and carports rear street

	Setting	Form	Materials
<b>Rear lane and rear street garages parapet and gabled roof form</b>	<ul style="list-style-type: none"> <li>▶ Build on rear boundary.</li> <li>▶ Minimise ramp up to garage.</li> <li>▶ Provide an acceptable interface on laneway (refer to C10).</li> </ul>	<ul style="list-style-type: none"> <li>▶ Horizontal parapet (flat roof) or pitched roof form.</li> <li>▶ Corner sites to have pitched roof form.</li> <li>▶ Pitched roof to match appropriate traditional roof pitch.</li> <li>▶ Double garages to have horizontal parapet form only.</li> <li>▶ A masonry to door ratio 1:1 is preferred.</li> </ul>	<ul style="list-style-type: none"> <li>▶ Rendered and painted masonry walls.</li> <li>▶ Corrugated steel roofing.</li> <li>▶ Timber or metal bi-fold doors, timber sliding doors, panel-lift doors or roller shutters.</li> <li>▶ Roller shutter and panel lift doors only if set within a masonry surround.</li> <li>▶ Paint finish to all doors (dark colour recommended)</li> </ul>

	Setting	Form	Materials
<b>Rear lane and rear street garages with garden roof</b>	<ul style="list-style-type: none"> <li>▶ Build on rear boundary.</li> <li>▶ Minimise ramp up to garage.</li> <li>▶ Provide an acceptable interface on laneway (refer to C10).</li> </ul>	<ul style="list-style-type: none"> <li>▶ Flat roof form only.</li> </ul>	<ul style="list-style-type: none"> <li>▶ Rendered and painted masonry walls.</li> <li>▶ Concrete slab to roof garden.</li> <li>▶ Timber or metal bi-fold doors, timber sliding doors, panel-lift doors or roller shutters.</li> <li>▶ Roller shutter and panel-lift doors only if set within a masonry surround.</li> <li>▶ Paint finish to all doors (dark colour recommended).</li> <li>▶ Simple timber or metal balustrade set behind masonry parapet if required.</li> </ul>
<b>Rear lane and rear street carport</b>	<ul style="list-style-type: none"> <li>▶ Build on rear boundary.</li> <li>▶ Minimum ramp up to carport.</li> <li>▶ Where site widths allow, a row of more than two carports must be interspersed with fencing or pedestrian gates.</li> </ul>	<ul style="list-style-type: none"> <li>▶ Flat or pitched roof form.</li> </ul>	<ul style="list-style-type: none"> <li>▶ Timber or metal posts or masonry reveals.</li> <li>▶ Timber, metal or masonry fascia.</li> <li>▶ Timber or metal bi-fold doors, timber sliding doors, panel-lift doors or roller shutters.</li> <li>▶ Paint finish to all posts, reveals and fascias.</li> </ul>

	Setting	Form	Materials
<b>Single garage or carport with existing street front zone access</b>	<ul style="list-style-type: none"> <li>▶ Behind outer front wall of building (refer to C8 for other criteria).</li> <li>▶ Minimum ramp up to garage or carport.</li> </ul>	<ul style="list-style-type: none"> <li>▶ Horizontal parapet (flat roof) or pitched roof form.</li> <li>▶ Pitched gabled roof form to match appropriate traditional gable roof pitch.</li> <li>▶ A masonry to door ratio 1:1 is preferred.</li> </ul>	<ul style="list-style-type: none"> <li>▶ Garage walls to be rendered and painted masonry.</li> <li>▶ Roof material to be slate, terracotta tile or corrugated steel appropriate to the building with which the garage or carport is associated.</li> <li>▶ Timber and metal posts to be paint finished.</li> <li>▶ Timber or metal bi-fold doors, panel-lift doors or roller shutters.</li> <li>▶ Roller shutter and panel-lift doors only if set within a masonry surround.</li> <li>▶ Paint finish to all doors (dark colour recommended).</li> </ul>
<b>Rear lane and rear street garage with loft</b>	<ul style="list-style-type: none"> <li>▶ Build on rear boundary.</li> <li>▶ Minimise ramp up to garage.</li> <li>▶ Provide an acceptable interface on laneway or street (refer to C10).</li> </ul>	<ul style="list-style-type: none"> <li>▶ Gable ended to rear laneway, rear street and rear yard along allotment axis.</li> <li>▶ Single loft only.</li> <li>▶ Traditionally proportioned double hung sash windows.</li> <li>▶ Skylights to be flat version.</li> </ul>	<ul style="list-style-type: none"> <li>▶ Rendered and painted masonry walls.</li> <li>▶ Corrugated steel roof.</li> <li>▶ Paint finish to all laneway and street doors (dark colour recommended).</li> <li>▶ Timber windows to loft.</li> </ul>

---

### C1.5.7 Lofts over garages and studios

---

There is a demand for additional structures located over single storey garages and studios located at the rear of properties. Lofts provide benefits such as added accommodation, surveillance to laneways, increased public and private security and safety, and in some instances improvements to a laneway appearance.

However, there are many parts of Paddington where loft structures are inappropriate. To determine whether a loft structure over a single storey garage or a studio would be acceptable, consideration must be given to the significance of the existing rear building form and lot size, the relationship to the adjoining properties, the laneway characteristics where relevant and impacts on privacy.

#### Objectives

- O1 To ensure that loft structures over garages or studios are sympathetic in their location, massing, form and scale to the traditional rear elevations, yards, and laneways.
- O2 To ensure that loft structures over garages or studios do not detract from the significance of unaltered groups of buildings.
- O3 To ensure that loft structures over garages or studios do not impact on the privacy of adjoining properties.
- O4 To ensure that loft structures do not result in a non-compliance with the private open space and deep soil landscaped area requirements.
- O5 To ensure that loft structures are appropriately orientated to minimise overshadowing on adjoining/adjacent open space.
- O6 To minimise the visual impact of loft structures when viewed from public areas and private land.
- O7 To ensure that loft structures above garages and studios do not preclude the maintenance and conservation of items that contribute to the significance of the heritage conservation area.

#### Controls

- C1 Loft structures may be permitted where:
  - a) the site dimensions are a minimum of 30m long and 5.24m wide and where the structure will not adversely impact on the traditional character of the rear elevations, yards, and laneways;
  - b) the structure will not adversely impact on the amenity, visual privacy and overshadowing of the property, neighbouring properties and public open space (the controls in Section 1.4.5 Building height, bulk, form and scale apply);
  - c) the structure does not require the footprint of the garage or studio to be extended so that the controls in Section 1.4.8 Private open space, swimming pools, courtyards and landscaping cannot be satisfied. Where there is an existing non-compliance with

---

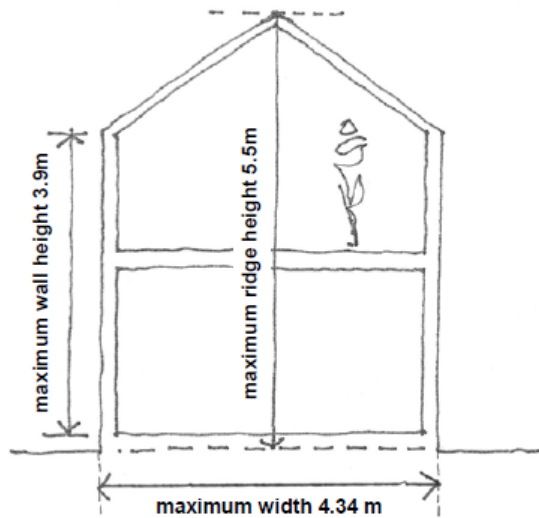
these controls, the existing private open space and deep soil landscaping is not to be further reduced;

- d) all access to the loft is provided internally;
- e) habitable room windows within the loft with a direct sightline to the habitable room windows in the existing building on the site and neighbouring buildings have a separation distance of at least 9m;
- f) the structure extends over only a single space garage or studio;
- g) the loft and garage (or studio) structure is a maximum of 4.34m wide;
- h) the roof structure is gable ended to the rear boundary, with a maximum ridge height of 5.5m and maximum wall height of 3.9m (on or adjacent to a side boundary);
- i) windows are located only in the centre of gable ends and must be either: a single double hung sash window, or inward opening window of traditional proportions;
- j) does not include balconies, decks, or other similar cantilevered structures;
- k) a maximum of two skylights per roof plane, provided they comply with controls C28, C29 and C30 in Section 1.5.1 Dormers and skylights;
- l) the ground floor level of the principal building form is higher than the natural ground level at the rear boundary; and
- m) the maintenance of elements that contribute to the heritage conservation area, such as sandstone walls, will not be adversely affected. Also refer to C1.5.6 Fences, walls and gates.

C2 Loft structures will not be permitted:

- a) over garages or studios in the street front zone;
- hh) if the subject property is part of an original row of houses, comprising an unaltered group, and the proposal demonstrates an adverse impact on this group;
- ii) if the rear of the property is orientated towards the north between NNE and NNW (true north) (see Appendix 1);
- jj) with a dormer window; and
- kk) over a multiple space garage.

**FIGURE 27** Loft structure design example including dimensions



### C1.5.8 Materials, finishes and details

Buildings in Paddington were constructed from a distinct and limited range of materials. Similarly, there is a pronounced repetition of detailing in surface treatments and building components.

Materials, finishes and detailing are two important elements which unite the area and contribute to Paddington’s character. The repetitive combination of materials and the manner in which they were used for specific parts of buildings also forms part of Paddington’s significant character.

The use of modern day materials and contemporary design approaches can be successfully employed in Paddington provided the relevant aspects of context are respected.

The table following the objectives and controls below sets out traditional external materials found within Paddington. It lists materials suitable for new development, alterations and additions. Additionally it lists materials which are intrusive elements, either by their very nature or if used in inappropriate situations.

#### Objectives

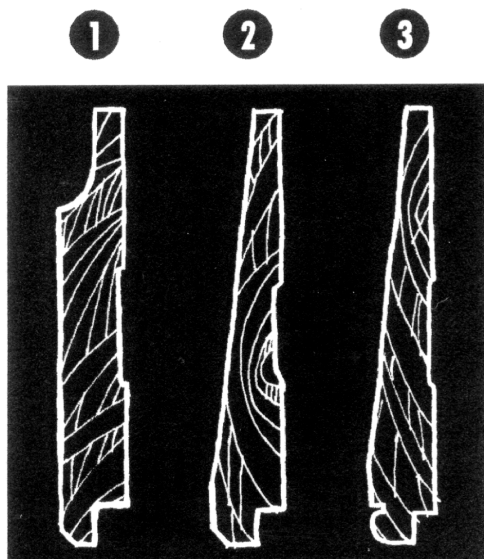
- O1 To retain and conserve traditional materials, finishes and details.
- O2 To promote high quality design, materials, finishes and detailing which is appropriate to the architectural style, building type, and historic context.
- O3 To conserve original external finishes.



## Controls

- C1 Surviving original materials, finishes, textures and details on street front elevations are to be retained and conserved.
- C2 Original brickwork, sandstone, terracotta, glazed or tessellated tiling that is unpainted or unfinished by other mediums must not be rendered, bagged, painted or otherwise refinished in a manner inappropriate to the architectural style of the building.
- C3 Render must not be removed from the exterior face of buildings unless it is proposed to re-render the surface immediately. Where original render has been removed from the exterior face of a building, new render must be applied and painted. Special consideration will be given to a building in a group.
- C4 New materials, finishes, textures and details on the principal building form and elevations visible from a public space, must be traditional and appropriate to the architectural style of the building. Intrusive materials are not permitted.
- Table 8 below sets out traditional external materials found within Paddington and those materials permissible for new development, including alterations and additions.
- C5 New external materials and details to additions must complement the architectural character of the existing building and minimise the apparent bulk of the addition.
- C6 Infill buildings must use materials, finishes, textures and details appropriate to the building type and style but should not replicate traditional details.

**FIGURE 28** Traditional cladding profiles



- 1 Rusticated weatherboard
- 2 Chamfered boarding
- 3 Beaded boarding

**TABLE 8** Materials and details

Building component	External building materials
<b>Roofs</b>	
Traditionally	<ul style="list-style-type: none"> <li>▶ Natural slate such as Welsh slate and South Australian slate. Later Victorian or Edwardian terraces occasionally had traditional ornamental patterns which may have been in contrasting colours.</li> <li>▶ Corrugated galvanised iron in short lengths and associated details and fixings.</li> <li>▶ Unglazed terracotta tiles on Federation period buildings and post- Federation buildings.</li> </ul>
New roofs to existing buildings - replacement and additions (including courtyard housing additions and lofts over garages)	<ul style="list-style-type: none"> <li>▶ Galvanised corrugated steel with associated galvanized gutter details and fixings.</li> <li>▶ Pre-painted corrugated steel in light to mid grey tones, similar in appearance to traditional corrugated iron.</li> <li>▶ Traditional roof materials as outlined above.</li> </ul>
Intrusive roofs for existing buildings - replacement and additions	<ul style="list-style-type: none"> <li>▶ Concrete roof tiles.</li> <li>▶ Metal roofing sheets or panels in inappropriate colours.</li> <li>▶ Non-traditional metal roof profiles.</li> <li>▶ Terracotta tiles on pre-Federation period buildings.</li> <li>▶ Glass (other than permitted in skylights).</li> </ul>
<b>Walls</b>	
Traditionally	<ul style="list-style-type: none"> <li>▶ Sandstone blocks for walls or as a base course to brick walls.</li> <li>▶ Timber weatherboards (depending on the building type). The profiles vary depending on the construction date.</li> <li>▶ Brick, which was usually rendered in Victorian era buildings and was often inscribed with ashlar coursing.</li> <li>▶ Face brickwork on Edwardian and late Federation style buildings. The associated details may include tuck pointing on the principal elevation and areas of roughcast render.</li> <li>▶ Corrugated galvanised iron, zinc coated corrugated steel ripple iron and weatherboards on sides of dormer windows and outbuildings.</li> </ul>

Building component	External building materials
New walls to additions	<ul style="list-style-type: none"> <li>▶ Traditional wall materials including sandstone blocks, timber weatherboard or brick.</li> <li>▶ Corrugated galvanised iron, zinc coated corrugated steel ripple iron for small expanses only. Must be in appropriate colours and subject to low reflectivity.</li> <li>▶ Rendered brick, with or without inscribed ashlar coursing where appropriate.</li> <li>▶ Fibrous cement sheeting with a rendered and painted finish - for rear additions but only if window reveals of minimum 100mm external depth are achieved.</li> </ul>
Intrusive walls for existing buildings and additions	<ul style="list-style-type: none"> <li>▶ Stripped sandstock brickwork.</li> <li>▶ Circular pattern render (mock Spanish)</li> <li>▶ Glazed walls and glass bricks.</li> <li>▶ Metal wall cladding.</li> <li>▶ Metal mesh or perforated metal screens.</li> </ul>
<b>Windows</b>	
Traditionally	<ul style="list-style-type: none"> <li>▶ Timber framed, double hung sash windows, plain or multi-paned windows.</li> <li>▶ Plain glass, traditional patterned or coloured glass in some building types.</li> </ul>
New windows to existing building (replacement and additions)	<ul style="list-style-type: none"> <li>▶ Timber frames.</li> <li>▶ Steel frames on rear ground floor only.</li> <li>▶ Metal frames for ground floor shops and commercial premises where appropriate.</li> <li>▶ Plain clear glass.</li> <li>▶ Coloured and patterned glass for replacement in appropriate situations.</li> <li>▶ Fine metal frames in neutral tones.</li> </ul>

Building component	External building materials
Intrusive windows	<ul style="list-style-type: none"> <li>▶ Metal frames (including steel) to the principal building form and original secondary wings.</li> <li>▶ Window walls.</li> <li>▶ Bubble glass.</li> <li>▶ Glass blocks.</li> <li>▶ Timber or metal frames not reflecting traditional proportions.</li> <li>▶ Roller shutter security and sunscreen windows.</li> <li>▶ Horizontally sliding windows.</li> <li>▶ Aluminium framed windows in the front elevation and at the upper levels at the rear.</li> </ul>
<b>Doors</b>	
Traditionally	<ul style="list-style-type: none"> <li>▶ Timber solid core; principal doors are often panelled; utilitarian doors are often ledged and braced.</li> <li>▶ Etched or frosted glass in the top panels of late Victorian style doors and small coloured glass panes in Federation style doors.</li> </ul>
New doors to existing building (replacement and additions)	<ul style="list-style-type: none"> <li>▶ Solid core framed timber panelled doors to match original doors are required for reconstruction work.</li> <li>▶ Solid core timber framed, glazed timber-framed doors, glazed steel frame in appropriate locations.</li> </ul>
Intrusive doors	<ul style="list-style-type: none"> <li>▶ Fully glazed doors to the street front elevation of residential properties.</li> <li>▶ Hollow core and timber doors with detail and panels inappropriate to the architectural style of the building.</li> <li>▶ Roller shutter doors to residential houses, retail and commercial premises.</li> </ul>
<b>Shutters</b>	
	<ul style="list-style-type: none"> <li>▶ Traditionally detailed timber louvred shutters are applicable for windows and French doors on some building types.</li> </ul>
<b>Verandahs</b>	
Traditionally	<ul style="list-style-type: none"> <li>▶ Floors of stone flagging, marble, unglazed multi-coloured tessellated tiles.</li> <li>▶ Slate, timber and sandstone edging.</li> <li>▶ Cast iron posts of a flat profile or circular in section, cast iron friezes.</li> <li>▶ Timber posts and associated timber details for early Victorian buildings and Federation period buildings.</li> </ul>

Building component	External building materials
New verandahs - reconstruction	<ul style="list-style-type: none"> <li>▶ Traditional materials for reconstruction.</li> <li>▶ Materials similar to traditional materials but without elaborate detailing.</li> </ul>
Intrusive verandahs	<ul style="list-style-type: none"> <li>▶ Pebble-crete, modern concrete, large form modern tiles for original building types.</li> <li>▶ Polycarbonate or similar type material roofs.</li> <li>▶ Glass roofs to street elevations.</li> </ul>
<b>Balconies</b>	
Traditionally	<ul style="list-style-type: none"> <li>▶ Corrugated iron or slate roofs where appropriate to the style of the building.</li> <li>▶ Timber for floors and timber framing for the underside of verandah roofs.</li> <li>▶ Cast iron friezes and balustrade panels with iron or timber handrails for Victorian period buildings.</li> <li>▶ Timber balustrades for early Victorian buildings and Federation period buildings.</li> </ul>
New balconies - reconstruction	<ul style="list-style-type: none"> <li>▶ As with traditional materials for reconstruction on original building types or with modern-day equivalents.</li> <li>▶ Masonry and metal, other than perforated metal or mesh screens.</li> <li>▶ Reuse of salvaged cast iron friezes and balustrade panels with iron or timber handrails.</li> </ul>
Intrusive balcony materials	<ul style="list-style-type: none"> <li>▶ Smooth, textured or profiled face brick and exposed cement blocks.</li> <li>▶ Corrugated and other profiled metal sheeting.</li> <li>▶ Wire fencing.</li> <li>▶ Fibrous cement sheeting.</li> <li>▶ Glass balustrading.</li> <li>▶ Perforated metal or mesh screens.</li> </ul>

Building component	External building materials
<b>Fences</b>	
Traditionally	<ul style="list-style-type: none"> <li>▶ Occasionally rendered masonry with inscribed ashlar coursing.</li> <li>▶ Timber post, rail and paling.</li> <li>▶ Iron palisade, on sandstone or rendered bases.</li> <li>▶ Timber pickets.</li> <li>▶ Brick and timber fences or brick with iron inserts on Federation period buildings.</li> </ul>
New fences - additions	<ul style="list-style-type: none"> <li>▶ As with traditional fences but with consideration to building style and context.</li> <li>▶ Appropriate traditional materials for reinstatement of fences on original building types.</li> <li>▶ Contemporary interpretation of traditional fence details and materials such as iron palisade and timber.</li> </ul>
Intrusive fences	<ul style="list-style-type: none"> <li>▶ Smooth, textured or profiled face brick, exposed cement blocks, Ti Tree (brush), colourbond or sheet metal fences.</li> <li>▶ Full height brick fences.</li> <li>▶ Materials and forms that are inappropriate to the style of the building.</li> </ul>

Materials and details for infill development are provided in Table 2 in C1.3.13 - Infill development.

---

### C1.5.9 Exterior colours

---

Colour schemes make important contributions to the character of individual buildings and groups of buildings. Colour schemes can influence the cohesiveness of a group of buildings and an entire streetscape. They can be used to enhance important building features and reduce intrusive features. The use of historic based colour schemes is appropriate where an original colour scheme contributed to the architectural style of a building.

Exterior colours used on buildings constructed between 1850-1895 and 1895-1915, and even during the Inter-War period were from a comparatively narrow range. These colours were used to enhance the architectural style and to enhance the natural colours of construction materials. A range of exterior colours was used on buildings constructed in the early, mid and late Victorian period and in the Edwardian period. Colours were often used to enhance the architectural style and to highlight particular features and building components.

In determining a colour scheme the architectural style of the building must be considered. Georgian style buildings tended to have simply decorated exterior surfaces with only two or three colours. By the late Victorian period, when buildings were designed with a profusion of decoration, six or eight colours may have been used. Edwardian and Federation buildings used one or two lighter tones with a darker contrasting colour to enhance the unpainted brickwork. A wider range of colour finishes and a higher level of gloss were used for door and window joinery, verandah posts, valances, bargeboards and ornamental work.

For signwriting, trimmings and metal finishes typical colours included light brown, rich brown, Indian red, chrome green, and in rare instances Prussian blue, black and dark tints, and slate grey.

Special roof paints were available in the 19th century in a variety of colours. Common colours for roofs that were originally painted were light stone, slate grey and Indian red. Original colour schemes may be determined by the careful scraping of protected difficult to paint areas. They may survive under hardware, behind eaves, under window sills and on the more protected elevations of a building. Care should be taken to distinguish layers of paint finishes from undercoats.

Old photographs can provide valuable evidence of the original paint treatment, particularly in regard to the use of contrasting colours and tonal relationships for the various elements of the building.

## Objectives

- O1 To promote colour schemes that are appropriate to the character of the individual buildings, groups of buildings, the historic context.

## Controls

- C1 Colour schemes must be appropriate to the building type and style.
- C2 The use of fluorescent paints and primary colours are not permitted.
- C3 New buildings and additions in both the residential and commercial areas are to use colour schemes that have hue and tonal relationships with traditional colour schemes.
- C4 The intensity and hue of colour must relate to the style of the building and the streetscape context.
- C5 The whole face of the dividing party wall between attached buildings including terraces must be painted one colour. Painting with different colours to the centreline of a party wall is not permitted.
- C6 Matching buildings in a terrace row must be painted colours that are consistent in tone with the group.
- C7 Where terraces step down a hill, the colour of the front elevations of a terrace and its lower party wall including the return face and chimney above the roof line must be the same colour.
- C8 Where terraces are set back in plan, the forward terrace must be the colour of the exposed party wall, including the return face, up to the adjacent party wall.
- C9 Where it is proposed to introduce new exterior paint colours or modify the existing external paint scheme a colour board to be submitted to Council.

Note: Section 1.5.8 Materials, finishes and details specifies that original brickwork, sandstone, terracotta, glazed or tessellated tiling that is unpainted or unfinished by other mediums must not be rendered, bagged, painted or otherwise refinished in a manner inappropriate to the architectural style of the building.



---

### C1.5.10 Gardens and trees

---

The private gardens in Paddington have a considerable effect on the townscape quality. Both streets and lanes are enhanced by significant landscaping from adjacent private properties. Development, including excavation and landfill, can impact on the conditions in which trees grow. Remnant established gardens, parks and street trees make an important contribution to the character of the area.

#### Objectives

- O1 To retain traditional planting schemes and hard landscape elements where they exist.
- O2 To promote landscaping that is consistent with the character of the individual building, the characteristics of a group of distinctive buildings and the character of the heritage conservation area.
- O3 To ensure that front gardens are planted with a species selection that relates to the building type and is appropriate to the size and aspect of the garden space.
- O4 To create zones of rear planting with appropriate species of trees and shrubs.
- O5 To ensure that trees and shrubs do not have an adverse impact on the fabric of buildings and do not have an unreasonable impact on the amenity of occupiers or properties such that would warrant refusal or modification.

#### Controls

- C1 Significant gardens, or remnants of gardens with original planting schemes and hard landscape elements, such as paving and associated decorative elements, are not to be removed.
- C2 Significant trees are to be retained in place.
- C3 Front gardens should include original pathways and low formal planting which is appropriate to the building type, and allows views of the street front elevation to be maintained.
- C4 Rear gardens are to include one medium sized tree.
- C5 New trees must be a species which is suitable for a Paddington garden. The tree selection should have regard to matters such as size and orientation of the garden.
- C6 Excavation and landfill must not impact on the current and future health of significant trees that are located on the development site or on adjoining sites.

---

### C1.5.11 Satellite dishes, aerials, air conditioning units and other site facilities

---

Paddington’s roovescape is an integral component of its overall significance. The introduction of unsympathetic and uncharacteristic elements such as satellite dishes, aerials and air-conditioning units and external condensers can have a detrimental impact on the aesthetic significance of individual buildings and on the area generally.

The fixing of these structures on roofs and chimneys can also contribute to physical damage and possible loss of original fabric and detail.

The location and design of other site facilities such as fire safety systems, mail boxes, external storage facilities, clothes drying areas and laundry facilities can also have a detrimental impact on the appearance and character of the area and must be carefully considered.

Note: Solar energy systems such as photovoltaic electricity generating systems, solar hot water systems, or solar air heating systems are addressed in Chapter E6, Section 6.3 Solar energy systems.

#### Objectives

- 01 To retain the character of the original roovescape of Paddington.
- 02 To protect the original fabric and details of roofs and chimneys.
- 03 To ensure that satellite dishes, air handling systems, external hot water heaters, air conditioning units, aerials, fire safety systems and other site facilities do not detrimentally impact on the character and significance of individual buildings and the streetscape.
- 04 To minimise visual and acoustic impacts on adjoining properties.

#### Controls

##### *Satellite dishes, aerials and similar devices*

- C1 Satellite dishes, aerials and other similar devices:
  - a) are to be designed and scaled to minimise their visual impact and impact on the amenity of adjoining properties;
  - b) must not be located on any part of a roof or chimney which is visible from the street frontage or the public domain; and
  - c) must not have a detrimental impact on the architectural style or significance of the building to which they are attached.

##### *Air conditioning units, condensers and other mechanical plant equipment*

- C2 Air conditioning units, condensers and other mechanical plant equipment in infill development or substantial additions must be located internally within the building.

- 
- C3 Any part of an air conditioning unit, condenser and any other mechanical plant equipment located externally must be located:
- d) behind the outer front wall of the building and not be visible from the public domain;
  - e) less than 1.8m above existing ground level or a basement level or part underground level (but not on a roof); and
  - f) to minimise noise impacts on adjoining properties.
- C4 Air conditioning units, condensers and other mechanical plant equipment must be wholly contained within the permissible building envelope and not be visible from an adjoining property whilst being suitably located, designed, sized, enclosed, concealed, screened and/or otherwise integrated with the building.
- C5 External conduits must not exceed 3m in length and must not be visible from the public domain.
- C6 Condensers, units and conduits must not have a detrimental impact on the architectural style or significance of the building to which they are attached.

*Internal air conditioning systems and packaged air conditioning systems*

- C7 Any associated wall opening must be:
- a) behind the front setback and not be visible from the public domain; and
  - ll) no higher than 600mm above the ground level abutting the wall containing the new opening.

*Fire safety systems*

- C8 Hydraulic fire services such as fire hydrants and booster installations must be concealed. These services are to be:
- a) enclosed with doors if located in the building façade, or
  - b) housed in a cabinet or enclosure if located external to the building.
- The location, design, colour and material of the doors, cabinet or enclosure must be visually unobtrusive and suitably integrated with the development, including fencing and landscaping.

*Electricity substations*

- C9 An electrical substation is to be suitably located, screened and/or concealed so it is not visible from the street, or any other adjoining public place. Council's preference is for a chamber substation. Any screening or enclosure to conceal the substation is to be visually unobtrusive and suitably integrated with the development, including the fencing and landscape design.
- C10 The substation is to be located away from neighbouring properties or sufficiently screened from neighbouring properties.
- C11 The location and design of the electricity substation must be considered and integrated with the landscaping of the proposed development, and must ensure that:

- a) Vegetation does not overhang or encroach within the substation site.
- b) The substation is installed outside of the mature growth root zone of any trees to be retained, or proposed to be planted, to prevent roots damage to underground cables.

C12 The design and location of all other aboveground utility infrastructure (such as electrical pillars etc.) should minimise visual clutter within the streetscape and provide for a continuous accessible path of travel, where practical to ensure safe and equitable pedestrian circulation for people of all abilities. (Where this provision and Ausgrid's requirements cannot both be satisfied, the applicant is to develop in consultation with Council and Ausgrid a solution that meets the acceptance of both consent authorities.)

Notes:

- At the DA stage the applicant should demonstrate that they have engaged with Ausgrid and have a network capacity assessment undertaken for the proposed development.
- Where a substation is required, the substation should be identified on the DA plans and addressed in the *SEPP 65 Design Verification Statement* (also see Apartment Design Guide Objective 3C-2 Amenity of the public domain is retained and enhanced)
- The DCP requirements for substations apply in addition to the Ausgrid Network Standards, such as *NS113 Site selection and construction design requirements for chamber substations*. Separate Ausgrid approval for the substation will be required.
- A dedicated access way/easement through the site to the substation will also need to be provided in accordance with the requirements of Ausgrid and Council.

*Other Site facilities*

C13 Site facilities, including mail boxes, external storage facilities, clothes drying areas and laundry facilities, must be unobtrusively integrated into new development.

Note: Information relating to specific requirements for garbage and recycling is in Part E of this DCP, Chapter E5 Waste Management and in Council's DA Guide.

## C1.6 Public domain

The public domain describes those areas of land owned and/or managed by Council or other public authorities. The public domain includes roadways, gutters, kerbs, footpaths, street name inlays, retaining walls, landscaped verges and reserves, natural landforms and other elements located beyond private property boundaries.

Historically, the streetscapes of Paddington were characterised by a restricted use of materials, including paving, kerbing, street trees and street furniture. The simplicity of this palette allowed the built form to dominate, with embellishment being restricted to the often intricate detailing within the architecture.

The public domain plays a significant role in determining the overall character of the HCA. In addition to the following provisions, the general development objectives and controls in Section C1.4 also apply within the public domain.

### C1.6.1 Kerbs and gutters

The texture and colour provided by the sandstone kerbs and gutters in Paddington is an important characteristic of many streets and further defines the simplicity of the street geometry. Sandstone kerbs and gutters were deliberately introduced by the Paddington Council after 1871 as part of a works program aimed at improving the standard of public roads. These features therefore have historical and social significance as well as aesthetic significance.

#### Objectives

- O1 To retain the original sandstone kerbs and gutters.
- O2 To limit the range of materials used in kerbs and gutters to sandstone and concrete.
- O3 To ensure a homogeneity of colour and texture in materials when introducing or replacing kerbs and gutters.
- O4 To replace existing sandstone kerbs at the end of their useful life with new sandstone kerbs.
- O5 To re-establish sandstone kerbs and gutters where possible.

#### Controls

- C1 All original sandstone kerbs and gutters should be retained and, where possible, reinstated. If sandstone kerbs and gutters are required to be removed (for example in instances of new crossovers) they should be stockpiled for reuse in new works.
- C2 Where new sandstone kerbing is used it should be detailed to match the existing kerbing.
- C3 Where concrete kerbs are to be used, preference should be for precast segmental elements.

- C4 Damaged original sandstone kerbs and gutters should be restored where possible or replaced with new sandstone kerbs and gutters.
- C5 Vehicle crossings and chicanes are discouraged as they interrupt the original line of the streets and sandstone kerbing.
- C6 Maintain the line of kerbs parallel to the building line to preserve the character of the streets.
- C7 Where footpaths are widened, original sandstone kerbs should be left in their original position so that the earlier street form can be understood.
- C8 The profile of all new kerbs should reflect the traditional kerb detail.

---

## C1.6.2 Views and vistas

---

Paddington is characterised by panoramic views and closed vistas. Panoramic views result from the suburb's dramatic topography and position in relation to the harbour and City skyline.

The closed vistas are created by the street configuration which is strongly defined by the terraces with their zero setbacks from street and lane junctions.

The skylines along the southern and eastern edge of the heritage conservation area are formed by the profile of buildings on the Oxford Street and Jersey Road ridges. Landmarks do not feature on the horizon with notable exceptions such as the Royal Hospital for Women chimney and occasional contemporary multi-storey buildings.

Downhill panoramic views from points west of Cascade Street can extend as far as the Harbour especially from elevated viewpoints. Views of the harbour do not occur from points below the level of the Scottish Hospital or from east of Cascade Street.

Views of the City skyline and especially known landmarks such as Centrepoint Tower can be seen from many of the streets with east-west and north-west orientation. Views towards Paddington from New South Head Road and from the ridge along Jersey Road are panoramic and reveal the close-textured fabric of Paddington.

Closed vistas are characterised by the stepped alignments of terrace houses following a change in street direction or up a slope and punctuated by gable walls and corner shops on corners. The closed vista skyline is notable for the fine serrated profile of gabled parapet walls and chimney stacks.

### Objectives

- O1 To retain existing vistas and create opportunities for new views where possible.
- O2 To ensure street tree planting enhances views both to and from Paddington.

### Controls



- C1 New development and street tree planting should respect existing view corridors.
- C2 New development in the public and private domain should be designed and located to minimise the impact on existing vistas or improve existing vistas where possible.
- C3 Removal of trees and demolition of contributory buildings, in whole or part, for the sole reason of creating or improving views and vistas will not be supported.

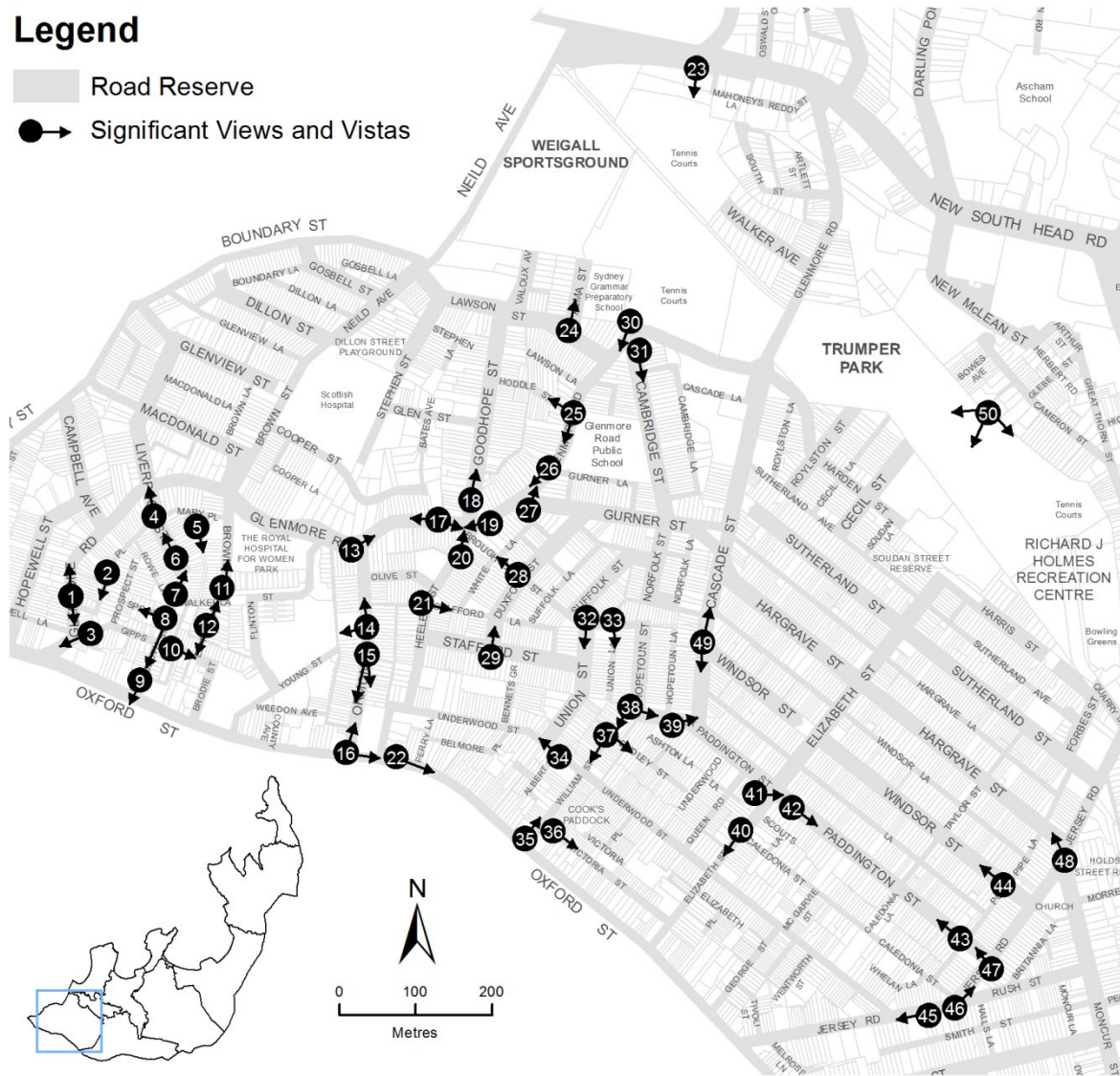
Significant views and vistas

MAP 2 Significant views and vistas

Note: The following diagrams show a selection of significant views and vistas. These diagrams are not intended to represent all the significant views and vistas.

Legend

-  Road Reserve
-  Significant Views and Vistas

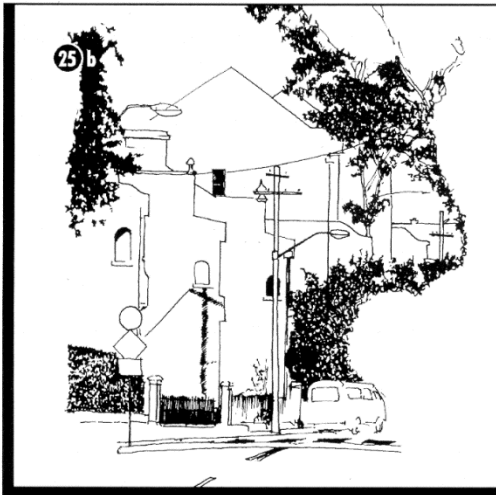
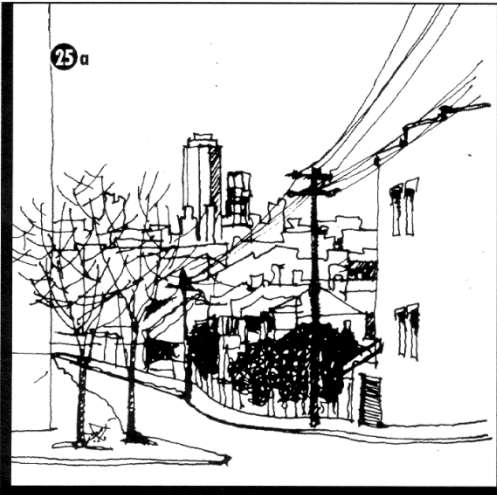
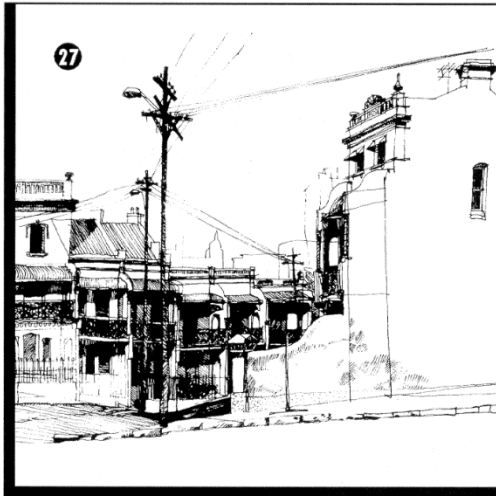
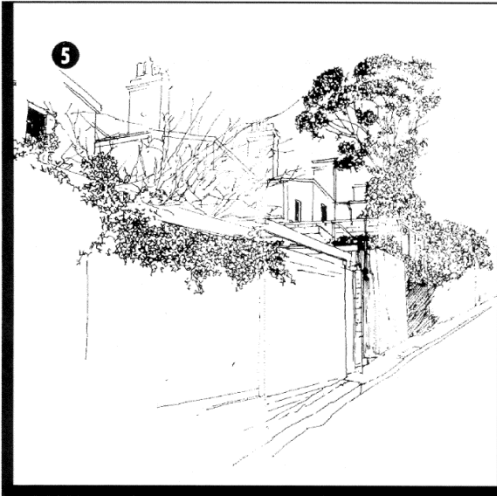






### Significant views and vistas

- 1 (a) Glenmore Road - View north from Mary Place  
(b) Glenmore Road - View south to Gipps St corner
- 2 Mary Place - View south
- 3 Gipps St - View to Oxford St from Bethel Lane
- 4 Liverpool St - View north from Mary Place
- 5 Laneway west of Brown St - View from Mary Place
- 6 Liverpool St - View north
- 7 Liverpool St - View north from Rowe Lane
- 8 (a) Spring St - View from Shadforth St to Prospect St  
(b) Shadforth St - View to Oxford St from Spring St
- 9 Shadforth St - View to Oxford St from Gipps St
- 10 Gipps St - View east from MacLaughlin Pl
- 11 Brown St - View north from Walker Lane
- 12 (a) Alfred St - View from Walker Lane to the south  
(b) Alfred St - View north
- 13 Glenmore Rd - View east from Ormond St
- 14 (a) Ormond St - View north  
(b) Ormond St - View to the front wall of Engehurst
- 15 (a) Ormond St - View south-east  
(b) Ormond St - View south
- 16 (a) Oxford St - Looking west from Ormond St  
(b) Ormond St - View from Oxford St
- 17 (a) Glenmore Rd - View west from Five Ways  
(b) Five Ways - Looking east from Glenmore Rd
- 18 Goodhope St - View north from Five Ways
- 19 Five Ways - View west along Glenmore Rd
- 20 Five Ways - View north from the corner of Heeley St
- 21 Olive St - View from Heeley St
- 22 Oxford St - Looking west from Underwood St
- 23 Paddington from New South Head Rd
- 24 Alma St - View from Lawson St
- 25 (a) Hoddle St - View west from Glenmore Rd  
(b) Glenmore Rd - Looking south from Hoddle St
- 26 Glenmore Rd - Looking south to the corner of Gurner St and Five Ways
- 27 Corner Glenmore and Gurner Rds - Looking north
- 28 Broughton St - View to Five Ways
- 29 Stafford St - View from Duxford St
- 30 Corner of Glenmore Rd and Cambridge St
- 31 Cambridge St - View from Glenmore Rd
- 32 Union St - View from Broughton St
- 33 Union Lane - View from Broughton St
- 34 Underwood St - View from William St
- 35 William St - View north from Victoria St
- 36 Victoria St - View to Elizabeth St
- 37 (a) William St - View from Duxford St looking south  
(b) Dudley St - View from William St
- 38 (a) William St - View south from Paddington St  
(b) Paddington St - View from William St
- 39 Cnr Paddington St and Cascade St - View east from Paddington St
- 40 Elizabeth St - View south from Caledonia St
- 41 Paddington St - Close view from Elizabeth St
- 42 Paddington St - Looking east from Elizabeth St
- 43 Paddington St - View east from Jersey Rd
- 44 Windsor St - View west from Point Piper Lane
- 45 Jersey Rd - Looking south from Underwood St
- 46 Jersey Rd - View north from Rush St
- 47 Cnr Paddington and Jersey Rds
- 48 Cnr Jersey Rd and Hargrave St
- 49 (a) Cascade St - View north from Windsor St  
(b) Cascade St - View south from Windsor Lane
- 50 Trumper Park - Panoramic view



---

### C1.6.3 Public art

---

Paddington has a special cultural, social and educational value associated with the 1950s Bohemian movement and a number of outstanding Australian 20th century artists. The large number of art galleries and resident artists in the suburb are symbolic of Paddington's importance to the art world.

This cultural component of Paddington can be expressed through the incorporation of art works within its public domain.

Although the built form of Paddington maintains a remarkable uniformity, there is a wealth of incidental decoration within the articulation of the buildings. The detailing within a row of terraces was typically the work of a single builder, and as such, this handiwork now stands as a signature of that builder. Similarly, there is a richness of individual expression within the built form of Paddington that could be replicated within public spaces.

Note: Provision of public art is subject to Council's Public Art Policy.

#### Objectives

- O1 To enrich and enliven the experiential quality of the public domain through the provision of high quality works of contemporary art.
- O2 To provide opportunities for professional artists and the community to develop and manifest skills and capabilities.
- O3 To reinforce the unique qualities of Paddington through the provision of site-specific art work.

#### Controls

- C1 Selection of artworks should favour innovation and diversity.
- C2 Opportunities to showcase art by young designers may appear in places where transient displays are appropriate.
- C3 Artwork should have resonance and meaning to the community of Paddington.
- C4 Proposals should be low maintenance and vandal resistant.

## Appendix 1: Orientation of lots in the Paddington HCA

Note: This map is indicative only.



# Chapter C2 Woollahra Heritage Conservation Area

Part C ► Heritage Conservation Areas

CHAPTER C2 APPROVED ON 27 APRIL 2015  
AND COMMENCED ON 23 MAY 2015

Last amended on 22 December 2023



# Chapter C2 ► Woollahra HCA

## Contents

<b>C2.1</b>	<b>INTRODUCTION .....</b>	<b>1</b>
	C2.1.1 Background.....	1
	C2.1.2 Land to which this chapter applies .....	1
	C2.1.3 Development to which this chapter applies.....	2
	C2.1.4 Objectives .....	2
	C2.1.5 Relationship to other parts of the DCP.....	3
	C2.1.6 Definitions.....	3
	C2.1.7 How to use this chapter.....	4
<b>C2.2</b>	<b>UNDERSTANDING THE CONTEXT .....</b>	<b>5</b>
	C2.2.1 Description of Woollahra Heritage Conservation Area .....	5
	C2.2.2 The significance of the Woollahra Heritage Conservation Area .....	7
	C2.2.3 Building types.....	8
	C2.2.4 Contributory items and contributory groups .....	8
	C2.2.5 Desired future character of the Woollahra HCA.....	9
	C2.2.6 Conservation philosophy and management policy .....	9
	C2.2.7 Contemporary design in Woollahra .....	10
<b>C2.3</b>	<b>PRECINCTS .....</b>	<b>12</b>
	C2.3.1 Rosemont Precinct.....	13
	C2.3.2 West Woollahra Precinct.....	15
	C2.3.3 Queen Street Precinct.....	18
	C2.3.4 Nelson Precinct.....	21
	C2.3.5 Harbour View Precinct .....	24
	C2.3.6 Fletcher Precinct.....	26
	C2.3.7 Grafton Precinct .....	31
<b>C2.4</b>	<b>BUILDING TYPE CONTROLS .....</b>	<b>34</b>
	C2.4.1 Single storey residential buildings .....	35
	C2.4.2 Multi-storey dwelling houses.....	37
	C2.4.3 Semi-detached dwellings .....	39
	C2.4.4 Terrace style housing.....	41
	C2.4.5 Inter-War flat buildings .....	46
	C2.4.6 Retail and commercial buildings .....	50
	C2.4.7 Corner shops .....	51
	C2.4.8 Adaptive re-use of a non-commercial building for business purposes .....	53
	C2.4.9 Adaptive re-use of commercial and industrial buildings .....	53
	C2.4.10 Places of public worship, educational establishments and public buildings .....	55
	C2.4.11 Pubs .....	56
	C2.4.12 Infill development .....	58
<b>C2.5</b>	<b>GENERAL CONTROLS FOR ALL DEVELOPMENT .....</b>	<b>60</b>
	C2.5.1 Building height, form and character.....	61
	C2.5.2 Conservation of contributory items.....	64



---

C2.5.3 Conservation of contributory groups .....	65
C2.5.4 Materials, finishes and colours .....	67
C2.5.5 Roofs, skylights and chimneys .....	79
C2.5.6 Open space and landscaping .....	83
C2.5.7 Fences, gates and retaining walls .....	89
C2.5.8 Parking and garages .....	93
C2.5.9 Security .....	102
C2.5.10 Excavation .....	103
C2.5.11 Subdivision and site amalgamation .....	106
C2.5.12 Acoustic and visual privacy .....	107
C2.5.13 Site facilities and aerial devices .....	109
<b>C2.6 PUBLIC DOMAIN .....</b>	<b>112</b>
C2.6.1 Landscape elements .....	113
C2.6.2 Kerbs and gutters .....	114
C2.6.3 Public art .....	115
C2.6.4 Views and vistas .....	115
<b>C2.7 SCHEDULE OF CONTRIBUTORY ITEMS .....</b>	<b>116</b>

## C2.1 Introduction

### C2.1.1 Background

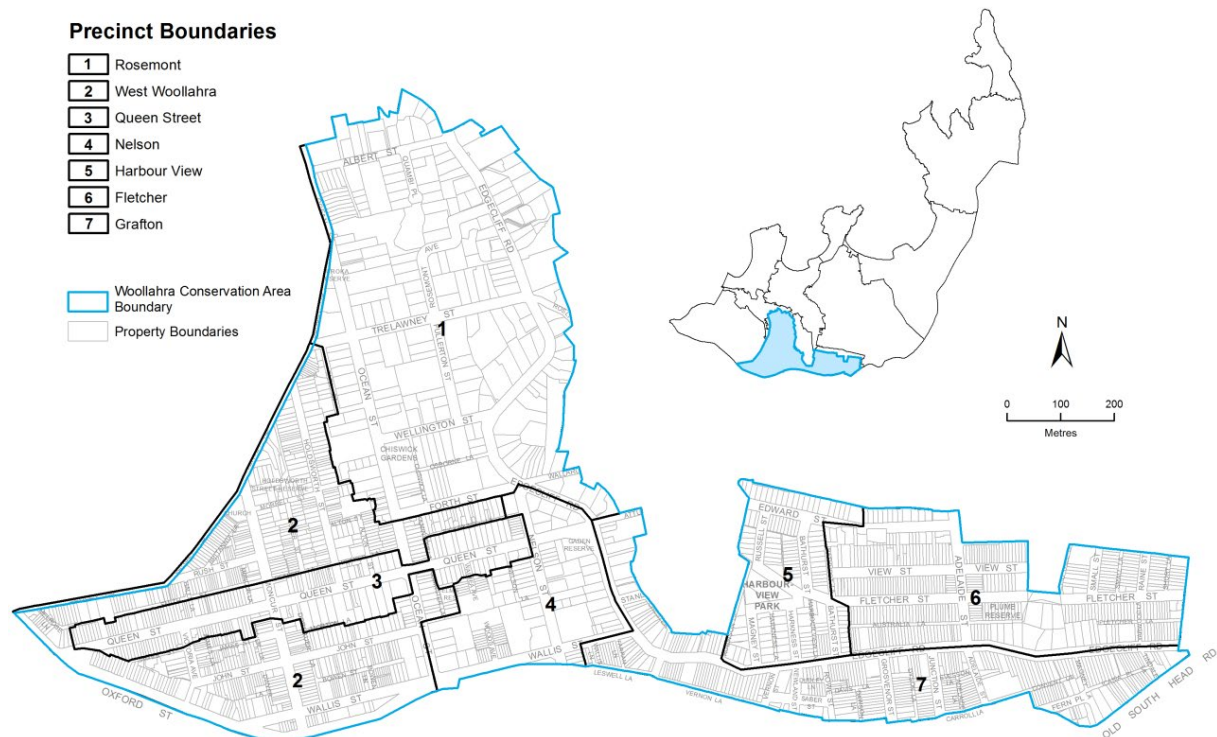
The Woollahra Heritage Conservation Area (Woollahra HCA) is a place of outstanding local heritage significance. The special character of the Woollahra HCA derives from its unique historic background and the expression of this background in its interrelationship of buildings, their settings, landscaping and open spaces, topography and land uses.

The significance of the Woollahra HCA derives not just from the heritage items listed in Woollahra Local Environmental Plan 2014 (Woollahra LEP 2014) but also from its large collection of contributory items and elements. Contributory items are listed in Section C2.7 and shown in Map 2.

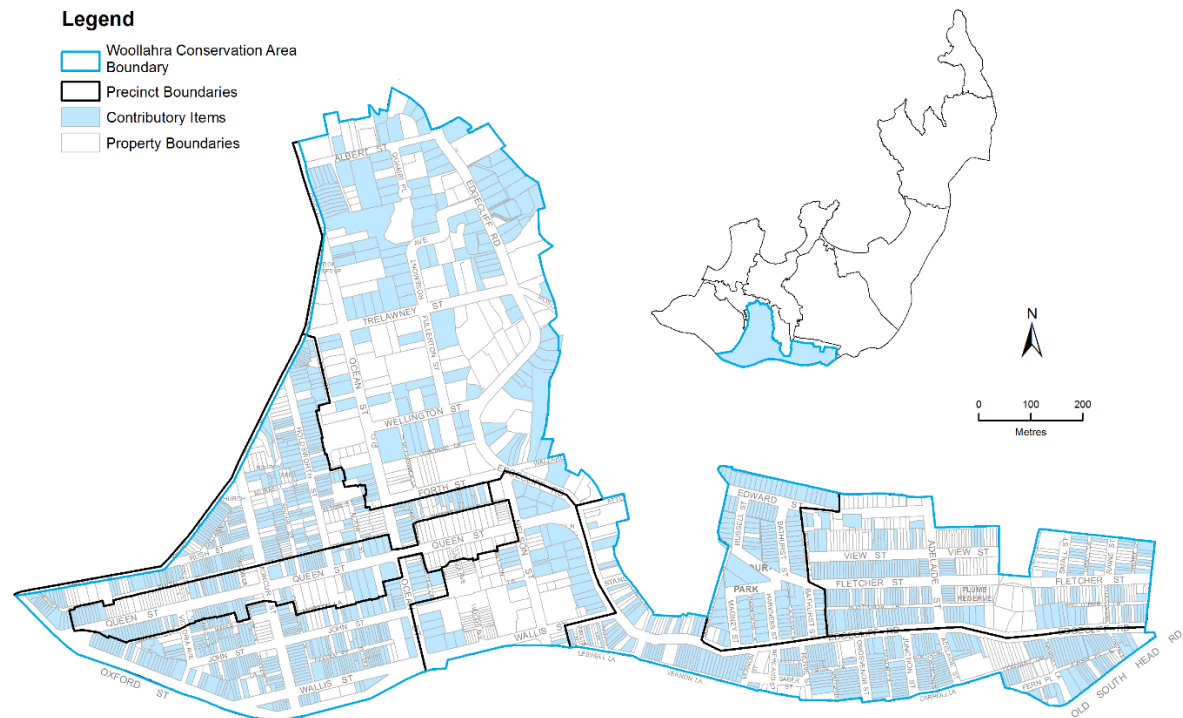
### C2.1.2 Land to which this chapter applies

This chapter applies to the Woollahra Heritage Conservation Area, which is shown in Map 1.

#### MAP 1 Land to which this chapter applies



## MAP 2 Contributory items



### C2.1.3 Development to which this chapter applies

This chapter applies to development that requires development consent under Woollahra LEP 2014.

### C2.1.4 Objectives

The objectives are:

- O1 To facilitate the implementation of the objectives and provisions relating to heritage conservation contained in Woollahra LEP 2014.
- O2 To acknowledge and conserve the heritage significance of the Woollahra HCA, including the character of individual precincts.
- O3 To encourage the retention and conservation of contributory items.
- O4 To encourage appropriate development of contributory items.
- O5 To provide controls to protect the identified heritage values and significant character of the Woollahra HCA.

- 06 To encourage contemporary design that responds appropriately to that character of the Woollahra HCA.
- 07 To enable appropriate and expert consideration of proposed development to be made by applicants and the Council.
- 08 To encourage and promote public awareness, appreciation and knowledge of heritage conservation.
- 09 To enhance amenity and heritage values within the Woollahra HCA.

### C2.1.5 Relationship to other parts of the DCP

---

This chapter is to be read in conjunction with the other parts of the DCP that are relevant to the development proposal, including:

- Part B: Chapter B3 General Development Controls, but only if the proposal is for a dual occupancy development (refer to Section B3.8 Additional controls for development other than dwelling houses).
- Part E: General Controls for All Development - this part contains chapters on Parking and Access, Stormwater and Flood Risk Management, Tree Management, Contaminated Land, Waste Management, Sustainability, Signage and Adaptable Housing.
- Part F: Land Use Specific Controls - this part contains chapters on Child Care Centres, Educational Establishments, Licensed Premises and Telecommunications.

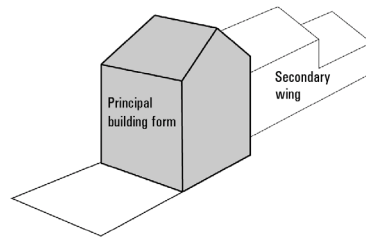
### C2.1.6 Definitions

---

The definitions below define words and expressions for the purpose of this chapter.

These definitions apply in addition to the definitions in Part A Chapter A3 of the DCP, the EP&A Act and Woollahra LEP 2014.

<b>ancillary development</b>	a building or structure, other than a dwelling house, dual occupancy, semi-detached dwelling, mixed development, attached housing, multi-dwelling housing, residential flat building or other housing type, but including sheds, pool houses, detached garages, gazebos, separate laundries, pagodas, swimming pools and pergolas.
<b>breezeway</b>	an unenclosed passage or void between the side boundary and rear wing.
<b>gable ended roof</b>	for the purpose of Section 2.5.8 Parking and garages, is a roof with a gable end facing the street or lane.
<b>principal building form</b>	the original front building section and main roof, which contains the main rooms (see diagram).



**transverse gable roof** for the purpose of Section 2.5.8 Parking and garages, is a roof with gable ends, where the ridge is parallel to the rear boundary.

### C2.1.7 How to use this chapter

#### Steps to be considered for all development

##### Step 1 Understanding the context

- ▶ Read Section C2.2 including the significance and desired future character of the Woollahra HCA.
- ▶ Identify the precinct where the subject site is located (refer to Map 1). Read about the precinct characteristics in Section C2.3 Precincts.

##### Step 2 Understanding your site

- ▶ Identify whether the building or site is a heritage item as identified in Woollahra LEP 2014.
- ▶ Identify whether the building or site is a contributory item (refer to Map 2 and Section C2.7 Schedule of contributory items).
- ▶ Consider the history and relationship of the site and surrounding sites, having particular regard to contributory items in the street.

##### Step 3 Addressing the objectives and controls

Each section must be read and the relevant objectives and controls applied:

- ▶ Section C2.3 Precincts: Identifies the significant characteristics and objectives for each of the precincts, also contains precinct specific controls for Queen, Nelson and Fletcher Streets.
- ▶ Section C2.4 Building type controls: There are 12 building types, each with specific objectives and controls.
- ▶ Section C2.5 General controls for all development: Applies to all development including contributory items.
- ▶ Section C2.6 Public domain: Applies to land owned and/or managed by Council or other public authorities.

## C2.2 Understanding the context

### C2.2.1 Description of Woollahra Heritage Conservation Area

The Woollahra HCA comprises a broad triangular plateau, sloping gently from the ridge that forms its southern and western boundaries to the escarpment above Double Bay. Early settlement took place within the confines of the Old South Head Road on the southern ridge (now largely Oxford Street), the Road to Point Piper (now Jersey Road) and Edgecliff Road skirting the Double Bay gully. Originally known in the 1850s as Upper Paddington, the area was later called Woollahra following the establishment of the municipality in 1860. Development from the 1880s was concentrated east of this area and also extended to the north of Edgecliff Road.

The distinguishing natural and built elements of the Woollahra HCA are:

- ▶ A topographic form that is generally relatively level but slopes along its eastern and northern boundaries towards the more dense vegetation of Cooper Park and the Double Bay gully. Distinctive long views towards the Woollahra HCA's buildings and trees, many of which are historically significant, are possible from the eastern end of the area.
- ▶ In the east and south-west of the Woollahra HCA, regular, gridded street patterns with alternating wide streets and narrow rear lanes. Houses are generally aligned to face the street. In the north, the grid expands to form much larger blocks and generally does not include rear lanes. Houses in this area are often aligned to face views to the harbour, Double Bay or across to Bellevue Hill.
- ▶ A land use character that is predominantly residential but also contains several shopping precincts as well as distinctive public, private, religious, light industrial and institutional buildings.
- ▶ A number of precincts that retain the architectural detailing, roof forms, materials, fencing and sometimes landscaping of their phase of development within the Woollahra HCA:
  - **Rosemont Precinct**, characterised by large lots including gardens, the villas and estate remnants of the mid Victorian period and the detached houses and Inter-War flat buildings;
  - **West Woollahra Precinct**, characterised by small lots and a variety of generally small scale cottages and terrace houses;
  - **Queen Street Precinct** with its mix of significant mid to late Victorian and Federation residential, civic and retail buildings;
  - **Nelson Precinct**, characterised by the highly consistent late Victorian Gothic style cottages of the Waimea and Woods Avenue groups, its gracious mid Victorian houses and its many Inter-War flat buildings;
  - **Harbour View Precinct**, developed by E.K. Harkness, with a fine collection of Federation period houses influenced by Victorian Gothic architecture and
  - **Fletcher and Grafton Precincts** with their variety of Victorian and Federation timber, stone and brick cottages, detached or semi-detached and terrace houses.

- 
- ▶ A visual and architectural complexity that derives from:
    - the variety of contributory public and private building types including residential buildings, institutional buildings such as schools; religious buildings including churches and synagogues; hotels, retail buildings, commercial and light industrial premises;
    - the variety of contributory architectural styles and scales within the range of building types;
    - the complex and varied subdivision pattern, which directly affected the sizes of buildings constructed in different parts of the Woollahra HCA;
    - contributory remnant landscape elements including front fences in a variety of styles that complemented the houses behind them, sandstone retaining walls and bedrock shelves, trees including Norfolk Island, Cook and Bunya pines from early estates and gardens, rows of street trees such as Moreton Bay and Port Jackson figs and London Plane trees, sandstone kerbs and gutters and red-coloured street-name inlays to footpaths; and
    - its municipal parks and small reserves, which often contrast with the dense urban fabric of the areas surrounding them.
  
  - ▶ A variety of open space and landscape features that include:
    - municipal street tree plantings;
    - small public parks;
    - private open spaces around institutional buildings;
    - remnant and distinctive trees from the gardens of large early estates. These make a strong contribution to the skyline of the Woollahra HCA and are visible from great distances;
    - private gardens that contribute significantly to the townscape quality of streets and laneways; and
    - leafy escarpment areas along Edgecliff Road and the borders of Cooper Park.

The division of the Woollahra HCA into seven precincts is a reflection of the varied development patterns that resulted from the large and unusual leasehold landholding of the area known as the Point Piper Estate.

The mid Victorian development of the West Woollahra precinct attracted working class people whilst the affluent owners built large residences in extensive grounds with harbour views in the Rosemont precinct. The areas between the Queen Street and Nelson precincts developed as a diverse mix of residences and shops as the gaps closed. The suburban boom of the 1880s in Woollahra continued the slow development trend with piecemeal development by local builders in the east, the Grafton and Fletcher precincts. Only the Harbour View precinct, the rapid work of a single builder, demonstrates an individual housing.

The Woollahra HCA has continued a pattern of redevelopment and infill that contributes to its significance as a rich and diverse conservation area with many fine architectural examples from every period of the 19th and 20th century. The identified precincts have different settlement patterns that demonstrate the distinguishing character elements that contribute to the overall significance of the Woollahra HCA. Many smaller precincts exist within the diverse precincts.

The precincts are shown collectively in Map 1.

---

## C2.2.2 The significance of the Woollahra Heritage Conservation Area

---

The Woollahra HCA has historical, aesthetic, technical and social significance at the local level.

The surviving built and natural fabric of the Woollahra HCA has significance for its ability to demonstrate the important historical phases of the area's development. These phases include the development of large estates during the mid-19th century, small lot residential development in the mid-19th century, retail development of the mid-19th to early 20th centuries, speculative subdivisions of the late-19th century, Inter-War consolidation and municipal improvements of the 20th century.

In its surviving elements of built fabric, the Woollahra HCA retains the potential to reveal evidence of ways of life, building and land uses which have now changed or disappeared.

Such fabric includes:

- ▶ early domestic kitchens and their associated service areas and technology;
- ▶ former stable buildings;
- ▶ outbuildings including early external toilets and garages;
- ▶ 'nightsoil' lanes;
- ▶ paling fences and gates to rear lanes;
- ▶ front fences and gateposts to buildings that have been demolished;
- ▶ bricked-up openings to former doors; and
- ▶ first floor loading bays to former industrial and storage buildings.

The Woollahra HCA has high aesthetic significance for its visual complexity derived from:

- ▶ the variety of significant public and private building types;
- ▶ the variety of significant architectural styles and scales within the range of building types;
- ▶ the complex and varied subdivision pattern;
- ▶ the significant intact and remnant landscape; and
- ▶ the municipal parks and small reserves.

The Woollahra HCA contains aesthetically contributory items of architectural excellence dating from all the major periods of its development, many designed by the eminent architects of their period.

The area has social significance for its association with the growth of the heritage conservation movement in Sydney during the 1960s. It was an early example of an area which received recognition by the National Trust and the Australian Heritage Commission through the efforts of the local community.



---

### C2.2.3 Building types

---

The area has a rich diversity of building types that include examples of the contrasting scale of the housing of Woollahra's social mix since the 1840s. All major architectural styles from each period exist throughout the area, demonstrating the continuing process of development that contributes to the heritage significance of the area.

The residential buildings range from small Victorian workers cottages and terraces, to villas and grand mansions from the large estates of the gentry. The boom style terraces of the 1870s and 1880s are similar to those in Paddington, but built in smaller groups. The late subdivision of the Cooper Estate is dominated by Edwardian cottages, semi-detached cottages and small groups of terraces often built with Victorian stylistic influences. Inter-War houses and flat buildings of every major style are concentrated in the subdivision of the earlier estates.

Further consolidation occurred in the 1960s, 1970s and 1980s with high rise flat buildings and small groups of town houses. Several excellent examples of contemporary infill dwellings co-exist throughout the area.

The Victorian and Edwardian period public buildings include two schools, a post office, former Council Chambers and a fire station. The hotels date from the Victorian and Inter-War periods. The religious buildings include Victorian, Federation and Inter-War churches and synagogues. The retail buildings include the special precinct in Queen Street and smaller groups in Ocean Street and Edgecliff Road with single shops occurring throughout the Woollahra HCA.

Section C2.4 contains a brief explanation of each building type with objectives and controls for alterations and additions that retain the essential character of each building.

### C2.2.4 Contributory items and contributory groups

---

Contributory items are those that contribute to and exemplify the heritage significance of the Woollahra HCA and are identified as heritage items or contributory items. Contributory items are buildings, structures, landscape elements and other townscape features, such as historic kerbs, gutters and street name inlays that contribute to the overall heritage significance of the Woollahra HCA. Contributory items are listed together in Section C2.7 and shown in Map 2. Heritage items are listed in Woollahra LEP 2014.

When a property has been identified as a contributory item, the listing includes all original fences, landscaping, trees, gardens and outbuildings as well as any building. This chapter therefore includes objectives and controls that apply to these important elements of the buildings' settings.

Section C2.5 General controls for all development, contains general objectives and controls for alterations and additions to contributory items and contributory groups.

---

### C2.2.5 Desired future character of the Woollahra HCA

---

In the Woollahra HCA, with its established and valuable historic character, new buildings and alterations and additions to existing buildings must be designed with close reference to their context.

Even small changes to buildings in the Woollahra HCA require careful consideration, especially where changes are visible from the street or from other public spaces. It is not just change to the street front elevations of buildings that is important. Alterations and additions at the rear of properties are also often visible from the public domain and can alter the proportion, scale and cohesion of a group of buildings.

In the Woollahra HCA, the aim is to establish a cohesive relationship between new work and the existing building fabric. This does not mean that additions should be designed in a historicist style. Contemporary design is often appropriate, as long as it responds to the relevant aspects of its context. Refer to Section 2.2.7.

Retention of original fabric and detail and the removal of inappropriate and intrusive building elements to the elevations of contributory items are also important. The reinstatement of missing detail and building elements is also encouraged.

The desired future character objectives for the Woollahra HCA are:

- 01 To retain its heritage significance and its recognition as a rare and distinctive urban area.
- 02 To retain and promote evidence of the historical development of the Woollahra HCA and its individual precincts and enables the interpretation of that historical development.
- 03 To maintain the residential character that has been predominant from the earliest phase of its development.
- 04 To maintain the character and significance of its identified precincts.
- 05 To retain the distinctive building types characteristic of the area and its precincts.
- 06 To continue to cater for a variety of uses and building types within a predominantly residential area.
- 07 To exhibit contemporary design excellence.

### C2.2.6 Conservation philosophy and management policy

---

This chapter adopts the conservation philosophy embodied in the Australia ICOMOS *Charter for the Conservation of Places of Cultural Significance* (the Burra Charter).

The Burra Charter is widely accepted by government agencies and private industry as the standard philosophy for heritage conservation practice in Australia. The Burra Charter sets down

---

principles, processes and practices for the conservation of significant places. Certain terms used in the Burra Charter are also used in this chapter.

Having regard to the heritage significance of the Woollahra HCA, Council has adopted the following policy as its approach to the management of the area. Council intends to implement this policy when assessing development proposals and when undertaking Council initiated work within the public domain.

### Objectives

- 01 To retain the heritage significance and significant characteristics of the Woollahra HCA and its precincts, including its variety of distinctive building types, the built and landscape evidence of its historical development and its public and private open spaces and gardens.
- 02 To allow removal or alteration of uncharacteristic features that detract from the significance of the Woollahra HCA.
- 03 To retain and conserve heritage items and contributory items including significant fabric, curtilages and settings.
- 04 To encourage the reconstruction of contributory items that have been unsympathetically altered.
- 05 To ensure that development is compatible with the significant characteristics of the Woollahra HCA and respects the principles contained in the Burra Charter.

### Processes

All applications for development within the Woollahra HCA will be assessed with regard to the impact of the proposed development on individual buildings, significant characteristics and the overall significance of the Woollahra HCA.

Council will require the preparation of a heritage impact statement and, in some cases, a conservation management plan may be required for major works. This applies to applications for whole and partial demolition, alterations and additions and new or replacement development.

A number of matters will be considered when Council assesses an application for demolition of a building in the Woollahra HCA including the proposal for replacement development.

Work undertaken by Council will comply with the above policy and will be subject to the same level of assessment as development on privately owned land.

Note: The term 'original' as used throughout the DCP refers to any significant fabric. This may be from a range of historic periods.

## C2.2.7 Contemporary design in Woollahra

---

Part of the cultural significance of the Woollahra HCA stems from its ability to demonstrate the important historical phases of its development between the mid-19th and mid-20th centuries.

---

The surviving built and natural fabric of the Woollahra HCA retain the potential to reveal further evidence of ways of life and of building and land uses which have now changed or disappeared.

Council does not advocate replication of historic architectural styles or the use of pseudo-period detail in new development. By adding a layer of development which illustrates the ways of life and design approaches of the early 21st century, contemporary design can contribute to the rich history of the Woollahra HCA and the expression of this history in the built fabric of the area. Inventive and interpretive contemporary design solutions of high architectural quality may be quite different in spirit and appearance from existing fabric while still providing a positive contribution to the continued history of the Woollahra HCA.

Contemporary design for infill development and for additions to contributory items is encouraged as long as it respects its context and achieves a cohesive relationship with existing historically significant fabric.

In some locations and circumstances, a traditional design approach may be required. Such an approach may be appropriate, for example, where alterations are proposed to a highly intact section of a building that has a high level of significance.

A thorough understanding of the historical background and physical context of the site will act as a guide to the appropriateness of the design approach. Designers will be required to demonstrate that the application of contemporary forms, materials or detailing provides an appropriate response to the streetscape, the precinct and the Woollahra HCA as a whole.

---

## C2.3 Precincts

This section identifies the significant characteristics and objectives for each of the precincts. Controls for the precincts of Queen Street, Nelson and Fletcher are also provided. These controls take precedence over the general controls for development in Section C2.5.

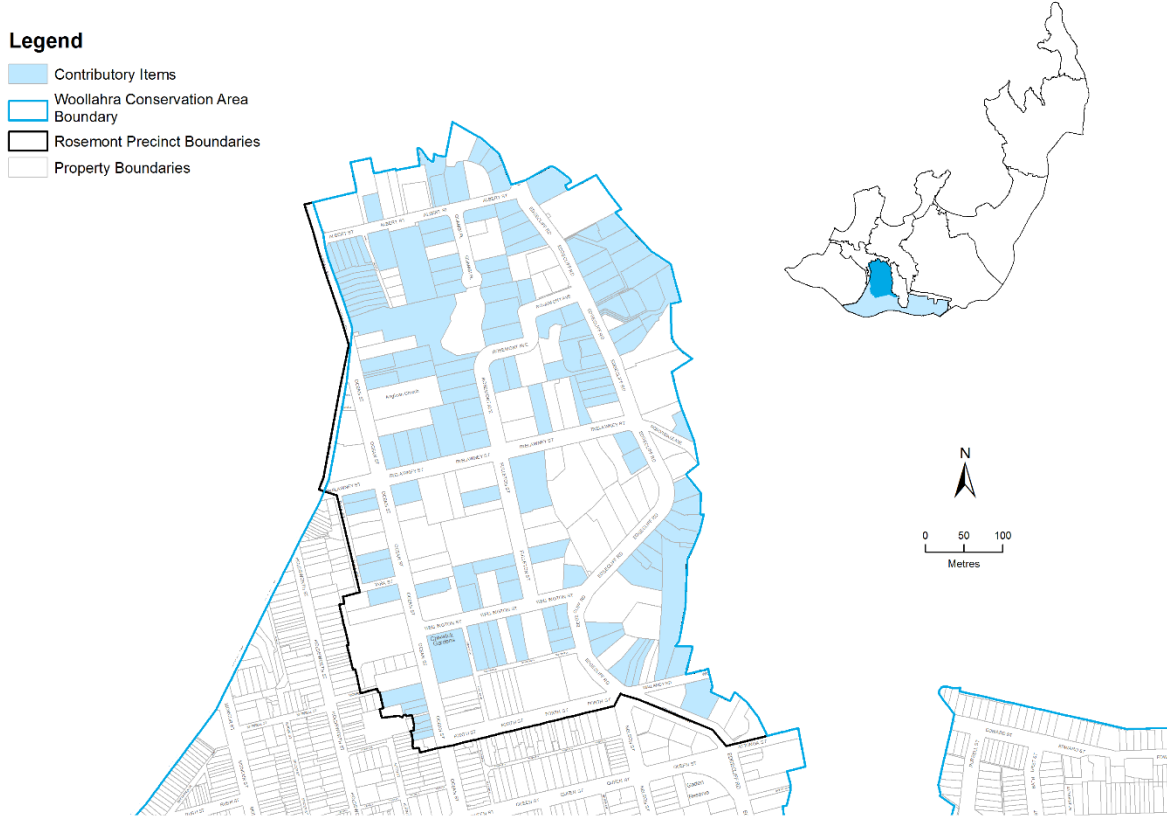
The Woollahra HCA is divided into seven precincts reflecting the varied development patterns that resulted from the large and unusual leasehold landholding of the area known as the Point Piper Estate. The identified precincts have different settlement patterns that demonstrate the distinguishing character elements that contribute to the overall significance of the Woollahra HCA.

The mid Victorian development of the West Woollahra precinct attracted working class people whilst the affluent owners built large residences in extensive grounds with harbour views in the Rosemont precinct. The areas between the Queen Street and Nelson precincts developed as a diverse mix of residences and shops as the gaps closed. The suburban boom of the 1880s in Woollahra continued the slow development trend with piecemeal development by local builders in the east, the Grafton and Fletcher precincts. Only the Harbour View precinct, the rapid work of a single builder, demonstrates an individual housing style.

The significant natural and built character elements to be retained for each of the precincts are detailed in this section.

### C2.3.1 Rosemont Precinct

**MAP 3** Rosemont Precinct – contributory items



#### Significant characteristics

- A subdivision pattern developed from former estates made up by large, sometimes irregularly shaped, lots that respond to the hilly topography and Edgecliff Road.
- Remnant substantial houses orientated towards the harbour views.
- Landscape features of the large early estates such as ‘Rosemont’ in Rosemont Avenue, the terraces and sandstone retaining walls from ‘Eynesbury’ in Albert Street, the Kauri Pine from the grounds of ‘Quiraing’ at 2 Trelawney Street and the later subdivision of Quambi and ‘Hillside’.
- Streetscapes of mature street trees, including the avenue of plane trees on Rosemont Avenue and the figs and plane trees on Edgecliff Road and Ocean Street. Substantial sandstone retaining walls respond to the steep topography.
- The combination of substantial Victorian houses within landscaped ground, located beside large Victorian or Federation terraces or semi-detached houses and Inter-War period houses and residential flat buildings. Gardens often contain mature trees such as pines, planes and figs. Front fences and gates are designed in association with, and to complement, the buildings behind.

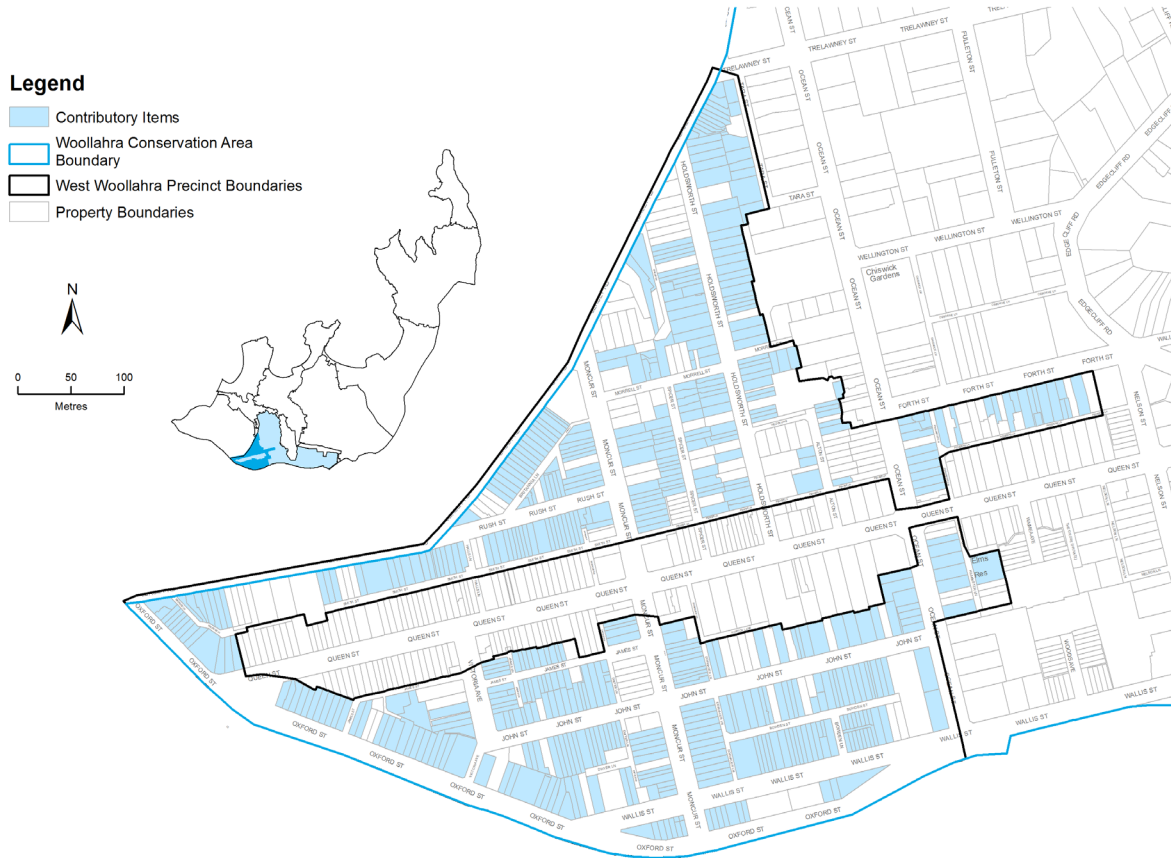
- 
- ▶ The variety of its residential architecture, which includes:
    - detached and semi-detached Victorian houses with external masonry walls of unpainted sandstone or painted stucco, often with decorative painted cement render mouldings. Roofs are steeply pitched and were generally originally clad in slate. Windows are vertically proportioned painted timber double-hung sashes. Porches or verandahs often had cast iron filigree detailing;
    - detached and semi-detached Federation houses usually in the Queen Anne style. Walls were originally unpainted brickwork. Open verandahs have turned and fretted timber work. Roofs are steeply pitched with tall chimneys and clad with slate or Marseilles pattern terracotta roof tiles. Windows are casements or double hung sashes with multi-paned tops lights;
    - Inter-War houses in an eclectic variety of styles typical of the period, including Spanish Mission, Mediterranean, Georgian Revival and Old English, usually with painted stucco walls and Roman, Spanish or Marseilles pattern tiles. The houses sometimes combine detailing from a number of these styles; and
    - Inter-War flat buildings usually in face brick with terracotta tiled roofs. The styles of the flat buildings often demonstrate the influence of the Inter-War domestic styles for detached houses. Skyscraper Gothic styled apartments are also present.
  - ▶ Garages and carports that are generally located within the property at some distance from the front boundary or accessible from a side street.
  - ▶ Substantial Victorian and Federation institutional and public buildings including the former Woollahra Council Chambers [Goethe Institute], Woollahra Public School and Fire Station, All Saints Anglican Church, St Columba Uniting Church, Little Sisters Convent and Wolper Hospital.
  - ▶ Chiswick Gardens, a municipal garden established in 1938.

## Objectives

- O1 To conserve the curtilages of the former estates and their landscaped garden settings, including outbuildings and fences.
- O2 To conserve the institutional public buildings and mature street trees.
- O3 To encourage contemporary infill development to respond appropriately to the Victorian, Federation and Inter-War housing which dominate the precinct.
- O4 To encourage alterations and additions to existing buildings which retain and enhance the character of the building and the streetscape.

## C2.3.2 West Woollahra Precinct

MAP 4 West Woollahra Precinct – contributory items



### Significant characteristics

- ▶ Its subdivision grid pattern of primary streets with secondary service lanes dating from the 1850s. The grids are generally rectangular, but are angled at their junctions with Jersey Road and Oxford Street.
- ▶ The retention of most of its original consistently narrow lots which run perpendicular to street frontages.
- ▶ A strong pedestrian character reflected in the narrow streets and interconnecting lanes.
- ▶ A varied scale of consistently Victorian character generated by its mix of small to medium-sized Victorian houses and different building types, some of which have new uses as shops:
  - individual single storey houses that are detached, attached or in small single storey terrace groups. Some of these are very narrow with no setback from the street, while others have front verandahs and gardens;



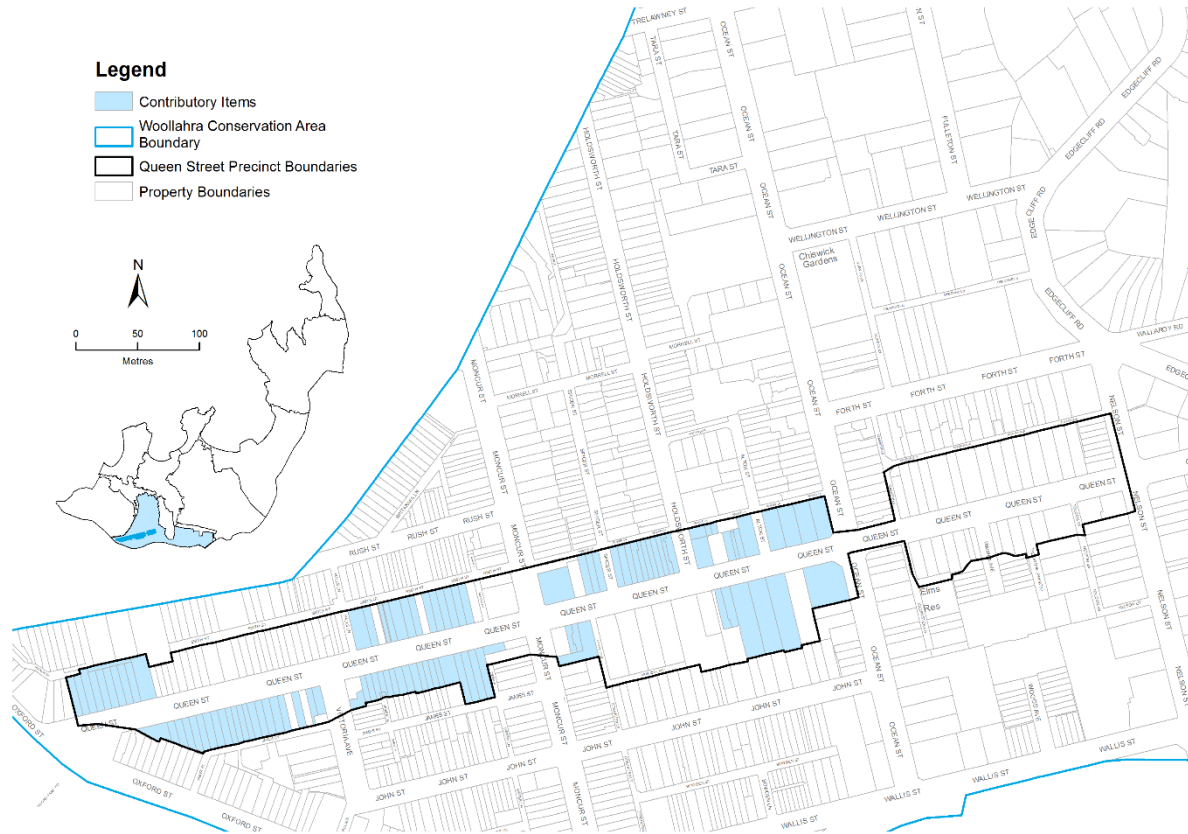
- 
- variously sized groups of two and three storey semi-detached and terrace houses. Generally, these houses are built with front verandahs and small front gardens, but some smaller examples are built to the front boundary with a cast iron palisade fence to the verandah at the boundary;
  - the sandstone and brick villa houses set back from the street boundary at the western end of Jersey Road. These are the largest single houses in the precinct and are surrounded by mature gardens, some with significant trees; and
  - shallow lots with small houses facing rear lanes such as Bowden Street and James Street, which are the smallest in the area. These cottages are often of stone or painted timber construction and are rare within the Woollahra HCA.
- ▶ A restricted palette of building materials and forms, typically:
    - external walls of painted stucco, sandstone or face brick. Many of the face brick houses in the precinct are the result of the inappropriate removal of an original painted stucco finish. The several painted timber-clad cottages are now rare in the conservation area; and
    - steeply pitched roofs which were originally clad in slate, corrugated iron or possibly timber shingles. Some terrace houses and cottages were designed with attic spaces and dormer windows.
  - ▶ Its front fences, typically cast iron palisade fences set on sandstone or rendered brick bases. Some houses, depending on their style, size or age, have timber picket fences or sandstone boundary walls. Original front fences usually allowed views through to the house, but many have been replaced by high masonry walls which have a negative impact on the streetscape.
  - ▶ Its street tree plantings, particularly the plane trees in Victoria Avenue, Wallis Street, Ocean Street and the western end of John Street.
  - ▶ Culturally significant landscape elements located at the rear lanes, including paling fencing, pedestrian gates, Victorian brick toilets and backyard plantings.
  - ▶ Garages and carports located in rear lanes rather than along street frontages. The few garages facing primary streets are generally intrusive.
  - ▶ Its mid Victorian corner shops, many now converted to residences, and the small retail precincts in Ocean and Moncur Streets and late Victorian hotels.
  - ▶ Remnant light industrial buildings converted for retail use (though some, such as the garage workshops in Oxford Street, remain). A former Inter-War garage in Wallis Street is a rare example in the Woollahra HCA of a garage with residential flats above.
  - ▶ The significant church in Jersey Road now converted to housing.
  - ▶ A synagogue in Oxford Street.
-

### Objectives

- 01 To ensure the conservation of the culturally significant landscape elements and street tree plantings.
- 02 To conserve the strong pedestrian character of the precinct as reflected in the narrow streets and inter-connecting lanes.
- 03 To encourage rear lane access for parking.
- 04 To encourage new development, including infill to complement the predominantly Victorian character of the precinct.
- 05 To ensure the preservation of original front fences.
- 06 To retain and conserve contributory items.

## C2.3.3 Queen Street Precinct

### MAP 5 Queen Street Precinct – contributory items



#### Significant characteristics

- ▶ "An informal 'town centre' focused around the intersection of Moncur and Queen Street which contains the Woollahra Hotel and former Woollahra Post Office."
- ▶ A cohesive main street character that is a combination of significant retail and residential buildings. These buildings generally retain their original features and are from various historic periods, but predominantly Victorian and Edwardian, with some Inter-War buildings.
- ▶ Its significant retail buildings including:
  - groups of shops, sometimes in pairs, forming continuous but diverse street facades from the late Victorian and Edwardian periods. Victorian buildings usually have parapet forms and painted stucco finishes, decorated with painted mouldings. Edwardian and Inter-War buildings generally have face brick, although some have been painted;
  - individually designed two- or three storey retail buildings with housing above from the late Victorian period; and
  - many retail buildings include original shopfronts or shopfronts which retain significant elements such as inset entrances, 'picture' windows, timber or brass framing, decorative tiles and glass. Some interiors are relatively intact.

- 
- ▶ Its significant residential buildings including:
    - single, two or three storey terrace houses in small groups or in runs of more than four, typically with small front gardens;
    - groups of small mid Victorian cottages and large late Victorian and Federation houses, some of which are attached, often set back from their boundaries with substantial gardens;
    - Queen Street Group: set between Nelson Street and Ocean Street, this is a highly intact group of mid to late Victorian houses in varying sizes and styles including Victorian Gothic revival, Italianate and Victorian filigree. They have a restricted palette of materials: walls of stone or painted and rendered brick with roofs of slate; and
    - small groups of three storey Inter-War flat buildings in face brickwork with decorative panels.
  - ▶ Its 'landmark' public buildings, including the former Masonic Lodge and ES&A Bank premises. Although the uses of some buildings have changed, their building fabric is still able to demonstrate their original functions.
  - ▶ Its distinct division into two sections reflecting the different stages of development on either side of Moncur Street.

The western section has:

- ▶ a topography that slopes gently down from Oxford Street to Moncur Street;
- ▶ retail and commercial buildings on both sides of the street, concentrated on the north with larger public and private buildings interspersed; and
- ▶ narrow, generally regularly sized, lots containing terraces and shops of two or three storeys. Shops are generally built to the front boundary, while houses are generally set back behind a small front garden and fence.

The eastern section has:

- ▶ a relatively level topography;
- ▶ substantial street trees which provide a canopy over the street;
- ▶ a variety of lot sizes with smaller lots generally on the northern side of the street;
- ▶ shops generally built to the front boundary on the southern side of the street;
- ▶ houses on the northern side of the street are generally built close to the front boundary and have small front gardens. On the southern side, some houses are set back from the street boundary within large gardens; and
- ▶ Inter-War flat buildings near Ocean Street.

## Objectives

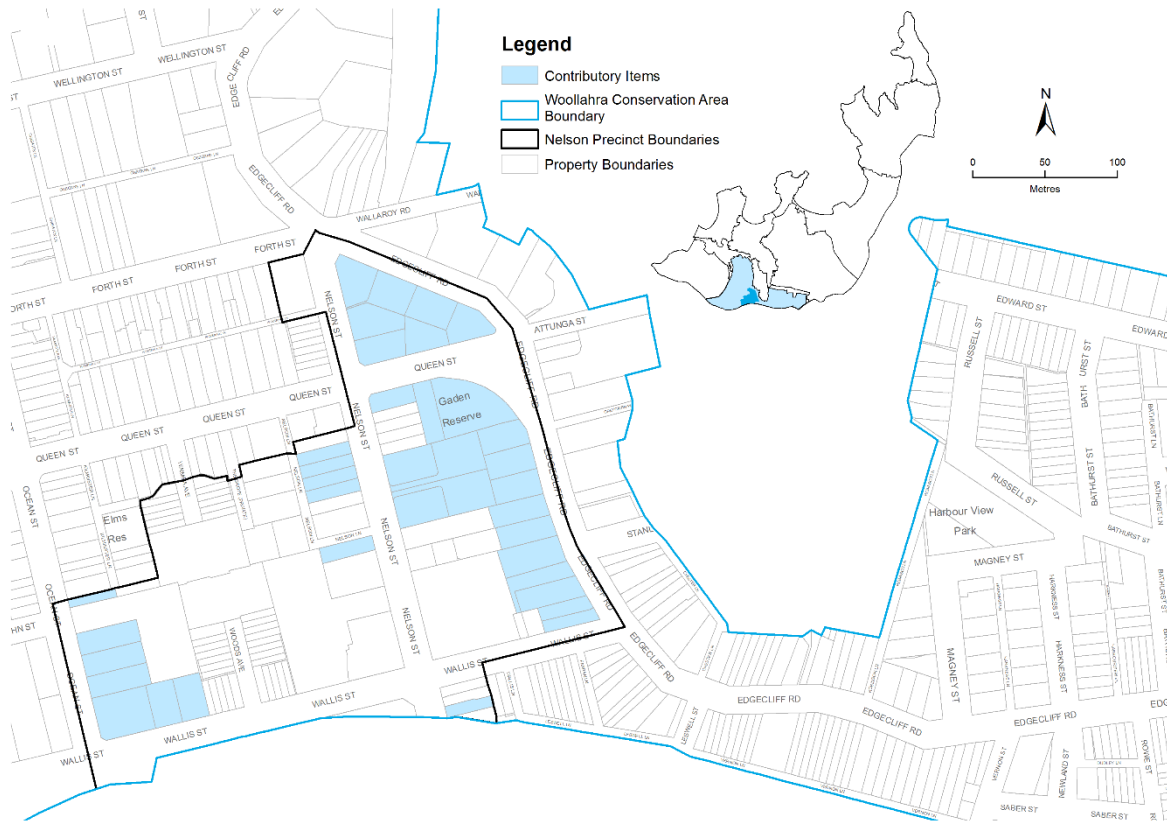
- 01 To improve and conserve the existing built form and cohesive main street character of Queen Street.
  - 02 To conserve the layout and size of existing front gardens due to their streetscape significance and contribution to the HCA.
-

### Controls

- C1 Refer to the building type controls for retail buildings contained in Section 2.4.6 which apply to the Queen Street precinct.
- C2 When development is proposed to an existing building with an intrusive shopfront or fence, the intrusive elements must be replaced as part of the development. The replacements must match the proportions, heights and material type of the original but must be detailed in a contemporary manner.
- C3 No new structures, other than a reconstructed fence, are permitted in the front gardens of any dwelling.

## C2.3.4 Nelson Precinct

### MAP 6 Nelson Precinct – contributory items



### Significant characteristics

- ▶ A relatively level topography with a steep drop to Edgecliff Road allowing many residential and institutional buildings along the ridgeline to gain views across the valley and Cooper Park to the east.
- ▶ The wide streets and groups of mature street trees, including figs, plane trees and eucalypts which are rare as street trees in the Woollahra HCA.
- ▶ The historic tramway lines that are reflected in the road alignments at the junction of Queen Street with Edgecliff Road and the curtilage of Gaden Reserve.
- ▶ The remnant landscape features of the early houses, such as the gateposts of ‘Heathfield’, the terraces and retaining walls between Nelson Street and Edgecliff Road and the landmark

Norfolk Island pine and fig trees associated with 'Brougham' in Nelson Street and 'Heathfield' (originally in Wallis Street).

- ▶ The remnant mid Victorian residences in the precinct, 'Apheta', 'Brougham', 'Glenhead', 'Larissa' and 'Waimea', some of which have been adaptively re-used and developed as institutional housing.
- ▶ Rare examples of Victorian planning which contrast with the linear Victorian planning common elsewhere in the conservation area:
  - **The Grove**, a small precinct linked to Queen Street by a leafy landscaped pedestrian way, with two storey houses facing Queen Street and four Victorian Gothic Revival styled cottages at the rear; and
  - **Woods and Waimea Avenues** in which groups of terrace houses are arranged with a sense of entry and a focus on the original house on the site.
- ▶ Significant Victorian housing including the following groups:
  - Waimea Avenue: two groups of six single storey Gothic revival styled brick terraces that are now painted. They have repetitive roof forms that were originally clad in slate, chimneys and scalloped timber barges. The front elevations have either bay windows or small verandahs;
  - Woods Avenue Group: two groups of six single storey Gothic revival brick terrace houses with either bay window fronts or small verandahs. Each has a steeply pitched roof that was originally slate with timber fretwork barge boards to the gables facing the street. There is also a group of four two storey terraces with Flemish gables, which are rare in the Woollahra HCA; and
  - Nelson Street: a group of seven Victorian Italianate terraces.
- ▶ Inter-War buildings located on the terraced gardens of early houses in Nelson Street and in Edgecliff Road which are predominantly Inter-War flat buildings characterised by:
  - hipped terracotta-tiled roofs or flat roofs, face-brick walls, often banded in contrasting colours with decorative detailing influenced by the eclectic styles of Inter-War housing. Brick front fences styled to match the building, or sandstone paving and garden beds contemporary with the flat building.
- ▶ Contributory items including:
  - Temple Emanuel, set back from Ocean Street behind a leafy forecourt. A landmark Inter-War brick building, it is decorated with symbolic patterns and a cast stone panel with religious motifs in low relief on the front elevation. The adjacent Neuweg Chapel has details influenced by the original synagogue.

## Objectives

- 01 To ensure the conservation of the landscape garden settings of the substantial houses and former estates.
- 02 To protect the heritage values of the early significant houses.
- 03 To preserve the public domain amenity in Waimea and Woods Avenue.

O4 To preserve the heritage values of the dwellings in Waimea and Woods Avenue.

#### Controls

- C1 Remnant landscape features from the early significant housing estates including the mature trees, terraced gardens and front fences are to be retained.
- C2 Council may require a conservation management plan (CMP) to be prepared and adopted by Council prior to development of contributory items and their existing curtilages.  
The CMP must identify master planning options for sympathetic additional development that will not adversely affect the significance of the property or the precinct.
- C3 The existing public views of the principal forms and settings of the terrace groups in Waimea and Woods Avenue are to remain unaltered.
- C4 Additions to the dwellings in Waimea and Woods Avenue must not be visible from the public domain and must maintain the significance of the group.



## C2.3.5 Harbour View Precinct

### MAP 7 Harbour View Precinct – contributory items



### Significant characteristics

- ▶ A steep topography where the designs of the houses were not altered substantially to suit the levels, resulting in repetitive stepping of the pitched roof forms in Bathurst and Edward Streets. Where necessary, sites were terraced and the houses built high above the street on level sites contained by sandstone retaining walls. Narrow openings in these walls provide access to stairs leading up to front doors.
- ▶ Houses that represent the distinctive transitional architectural style of local builder Edward Knox Harkness, who combined elements of Victorian Gothic revival and Federation detailing in dwellings that were built in small cohesive groups. A variety of forms of detached, semi-detached and single storey terrace houses that, through their restrictive palette of materials and distinctive decorative detailing, create a very consistent architectural group. The decorative details were applied to the range of house forms in a variety of combinations to achieve interest in the streetscape. The detached and semi-detached houses often contain projecting front rooms with gables facing the street. The terrace houses sometimes include small projecting bays to their front facades.

- ▶ Houses that incorporate the following elements:
  - steeply pitched roofs clad in terracotta Marseilles tiles, slate or a combination of the two materials. Chimneys are tall with terracotta pots;
  - face brickwork, now often painted, decorated with a combination of Victorian Gothic inspired timber fretwork and stucco moulded details;
  - timber posts, ornamental brackets and, often cast iron filigree, valances and front verandahs or porches with small roof bays or gables; and
  - vertically proportioned windows, with double hung painted timber sashes being most common.
- ▶ The streetscapes with their high aesthetic values enhanced by the central tree plantings in Magney, Harkness, Russell and Edward Streets.
- ▶ The centrally located ‘Harbour View Park’ that is an integral part of the Harbour View Estate development and retains structures from the initial period of development.

### Objectives

- 01 To ensure that future development maintains the high quality and aesthetic value of the streetscapes in the precinct.
- 02 To ensure development, including infill, complements the predominantly Victorian Gothic Revival and Federation character of the precinct.
- 03 To ensure that the repetitive rhythmic roofscape of dwellings is not broken by additional development that is visible from the public domain.

### C2.3.6 Fletcher Precinct

**MAP 8** Fletcher Precinct – contributory items



#### Significant characteristics

- ▶ Topographically, a plateau above Cooper Park that slopes slightly to the precinct’s western boundary at Bathurst Street. The wide streets and elevated position allow the penetration of sunlight to private and public space.
- ▶ An original Victorian rectangular grid street layout, with rear access lanes and rows of long narrow lots which run perpendicular to street frontages. The grid is separated by the site of

the former Fletcher Foundry. The grid ends abruptly at its border with Cooper Park from which winding pathways drop dramatically to the gully:

- short streets run north - south from Fletcher Street to the boundary of Cooper Park, with houses in these streets addressing the street not the park;
  - no rear lane occurs between Fletcher and View Streets. Instead the lots run from one street to the other resulting in groups of houses facing Fletcher Street sitting beside the rear boundaries of houses facing View Street; and
  - street corners are often defined by the side elevations of houses, the result of the subdivision pattern. Typically, these long, painted masonry elevations have few windows.
- ▶ Instances of divided streets, with the upper level running on an exposed sandstone bedrock shelf or above a sandstone retaining wall which results in some:
- sections of footpath raised above the street;
  - houses set above the street on level terraces retained by sandstone or brick walls, with a narrow opening allowing access up to the front door; and
  - culturally significant sandstone kerbs and gutters.
- ▶ Views to Cooper Park that can be gained from the pedestrian Adelaide Parade, and from Adelaide, Raine and Short Streets. Fletcher and View Streets provide long vistas across to Victorian villas and early pine trees in Edgecliff Road as well as to Sydney Harbour beyond.
- ▶ The eastern and western sections of the precinct, divided by Reddam House and Holy Cross College Primary School, which occupy part of the original site of Fletcher's Foundry. The western streetscapes of Fletcher Street and View Street are characterised by:
- single storey Victorian and Federation houses, some combined in consistent groups of detached, semi-detached or terrace houses with occasional two storey Victorian dwellings;
  - cohesive rows of Victorian and Federation terrace houses in Adelaide Street;
  - houses on the northern edge, in Adelaide Parade and some in View Street are oriented to face the view rather than the street;
  - recent intrusive developments in Fletcher and View Streets, have included garages to the main street frontage, or rear additions of inconsistent architectural style, orientated to the view and the northern aspect; and
  - the eastern end of the precinct retains individual single storey cottages, terrace like forms and small groups of two storey terrace houses. Small single storey timber and stone cottages from the Victorian and Edwardian periods are rare in the Woollahra HCA.
- ▶ The southern boundary of the precinct formed by Edgecliff Road and characterised by single storey and two storey Victorian and Federation housing, some in semi-detached pairs or small groups, and a group of commercial buildings near Grosvenor Street. This section also includes several Inter-War flat buildings.
- ▶ The precinct's contributory items that vary in architectural style, type, height and scale. This variety demonstrates the gradual nature of the phases of development in the precinct during the late Victorian, Federation and the Inter-War periods.
- ▶ A limited palette of dwelling materials and details including:

- 
- dwellings with dark dry-pressed face brick walls and a combination of moulded detail and timber fretwork, or painted stucco with moulded Italianate details, cast iron filigree fringes and valances. Some combine Victorian and Federation detailing in transitional style representative of the turn of the 20th century;
  - a small number of houses, now rare within the precinct, with sandstone walls or clad with painted timber weatherboards;
  - roofs that are generally steeply pitched and clad with slate, terracotta tile or corrugated iron roofs, depending on architectural style and period of construction; and
  - Inter-War flat buildings with terracotta tiled roofs and face brick, usually without decorative brickwork panelling.
- ▶ Original low front fences that allow views through small gardens to the dwellings and that are either:
    - cast iron palisades on sandstone or rendered brick bases, or timber picket fences to the Victorian and Edwardian dwellings; or
    - low masonry fences to Inter-War period flat buildings.
  - ▶ Retail buildings including remnant corner shops typical of a Victorian subdivision and now converted to form residences. Along Edgecliff Road, some Victorian houses have been altered to form shops and commercial premises. Some Federation and Inter-War buildings were specially designed for the purpose.
  - ▶ Contributory items including the synagogue in Fletcher Street, Seventh Day Adventist Church and the Holy Cross School in Edgecliff Road.

### Objectives

- 01 To ensure the preservation of public and private views of Cooper Park.
- 02 To ensure the preservation of cast iron palisade fences on sandstone bases that characterise Victorian and Edwardian houses.
- 03 To ensure the retention and conservation of contributory items.
- 04 To ensure development, including infill, is to complement the predominantly Victorian and Federation single storey, semi-detached and terrace houses that characterise the precinct.
- 05 To encourage low front fences consistent with the architectural style and period of the building.

### Additional objectives and controls—houses with rear access to a primary street

#### Objectives

- 01 To ensure that rear parking does not dominate the street frontage for sites with rear access to a primary street.
  - 02 To ensure that rear alterations and additions to houses with a rear frontage to a primary street do not dominate the streetscape.
-

---

*Controls*

- C1 Where the rear of a property faces a primary street (such as between Adelaide Parade and View Street and Fletcher and View Streets) a single car parking space is permitted at the rear of the property only if:
- a) a cross over exists;
  - b) the rear of the dwelling is at least 10m from the rear boundary;
  - c) the property is at least 5.2m wide;
  - d) the fence and portal to the car parking space are designed in accordance with the criteria for a single carport in Section 2.5.8, with a single pedestrian gate;
  - e) a pedestrian gate is adjacent to a minimum 0.5m wide deep soil landscaped area at the street front; and
  - f) the vehicular gate must be at least 80% transparent.
- C2 Where the rear of a property faces a primary street (such as between Adelaide Parade and View Street and Fletcher and View Streets) development at the rear of the dwelling is to:
- a) be clearly secondary in form to the principal form of the contributory items, or adjacent contributory items;
  - b) be 300mm below the ridge of the principal roof form to a single storey dwelling or less than the height of the principal eaves line if the principal form is a two storey dwelling;
  - c) be limited to the rear setback consistent with the group of contributory items to which it belongs or if an individual property, respectful of the consistent pattern of rear development in the vicinity;
  - d) be limited to the front setback of adjacent dwellings that face the other street front, to maintain the side setbacks consistent with the contributory group to which it belongs or, if an individual property, is to respect the consistent pattern of rear development in the vicinity;
  - e) to maintain storey heights consistent with the original rear forms adjacent; and
  - f) to have a parapet roof form if the rear roof forms of the adjoining dwellings in the group to which it belongs are inconsistent in form.
- C3 Where no rear access lane exists and the rear of the dwelling is orientated to a street (such as Adelaide Parade, and Fletcher and View Streets) garages to the rear of lots are permitted only if:
- a) the rear of the dwelling is located at least 10m from a street front;
  - b) the width of the property is at least 12m;
  - c) the garage is clearly secondary in form to the main house so that adjacent houses fronting the street remain the dominant forms;
  - d) a maximum of two separated car parking spaces or garages without lofts are permitted if the fence and portals to the car parking spaces are:
    - are integrated visually with the street wall
-

- leave 50% of the width of the street frontage available for pedestrian access
- allow for landscaping to be viewed above the wall in accordance with the criteria for a double carport in Section 2.5.8 with a single pedestrian gate.

### C2.3.7 Grafton Precinct

MAP 9 Grafton Precinct – contributory items



#### Significant characteristics

- ▶ The strong definition of its boundaries by the historic Grafton Estate at Edgecliff Road and the dominant form of Syd Einfeld Drive to the south.
- ▶ The Victorian street pattern grid of the original Grafton Estate subdivision remains with long, narrow lots laid out on an axis perpendicular to Edgecliff Road. This contrasts with the eastern end of the precinct which shows the later subdivision of the former Adelaide Brewery site.
- ▶ The topography slopes from south to north, creating streetscapes with repetitive stepped roof forms.
- ▶ The combination of residential, retail and commercial uses in buildings originally designed only for residential use near the Bondi Junction shopping centre gives the Grafton precinct a more urban character than most of the Woollahra HCA.



- 
- ▶ Its residential architecture, which is dominated by a variety of housing types from the late Victorian and Edwardian periods, with some Inter-War housing includes:
    - single storey houses with small front verandah and a variety of roof forms including hipped, gabled or skillion roofs behind parapeted front elevations;
    - often in small groups, two storey terrace houses set behind palisade fences with verandahs and small gardens;
    - three storey terrace houses, which are rare within the precinct;
    - Inter-War flat buildings.
  - ▶ The gradual and erratic nature of development within the Grafton Estate is illustrated by the differing architectural forms, styles and scale of the houses and the variety of groupings within the precinct.

The restricted palette of construction materials and details, which are generally identifiable as Victorian, Federation, or Inter-War flat buildings:

### ***Victorian***

- ▶ Masonry walls with painted stucco, vertically proportioned timber double-hung windows, molded cement render detailing, decorative cast iron filigree to balconies and verandahs with steeply pitched slate roofs.
- ▶ Painted timber weatherboards and vertically proportioned timber double-hung or casement windows.
- ▶ Timber and cast iron filigree detailing to verandahs and balconies and steeply pitched corrugated iron roofs.

### ***Federation***

- ▶ Unpainted dark face brick walls, painted vertically proportioned timber double or casement windows and timber fretwork decoration to verandah roofs.
- ▶ Roofs are hipped or gabled forms with terracotta Marseilles tiles.

### ***Inter-War flat buildings***

- ▶ Walls are face brickwork with patterned or polychrome details and stepped parapets influenced by Art Deco architecture.
- ▶ Altered buildings have painted rendered walls, terracotta tiled roofs and double hung painted timber sash windows.
- ▶ Typical cast iron palisade fences set on sandstone or rendered brick bases. Some houses, depending on their style, have timber picket or brick fences. Residential flat buildings in the Grafton Precinct are generally built to the street alignment or are set behind sandstone walls which retain narrow garden beds.

- ▶ The retail centre along Edgecliff Road, including corner shops from the Victorian period and commercial buildings from the Inter-War period.
- ▶ The significant public buildings including the Holy Cross Catholic Church, Reddam House School, formerly Holy Cross College, and the synagogue and Jewish community centres in Saber Street.

### Objectives

- 01 To ensure the retention and conservation of the significant public buildings.
- 02 To ensure new development, including infill, complements the predominantly late Victorian Edwardian and Inter-War character of the precinct.
- 03 To ensure original palisade front fences on sandstone bases are preserved.

## C2.4 Building type controls

To protect the heritage significance of the Woollahra HCA it is important to retain and conserve the many building types that represent the significant phases of the suburb's historical development.

The applicant is to identify which of the building types listed below are relevant to the proposal, and comply with the objectives and controls for that building type. Where development involves an existing building, more than one building type control may apply.

### Building types

The building types in this section are:

- ▶ 2.4.1 Single storey residential buildings
- ▶ 2.4.2 Multi-storey dwelling houses
- ▶ 2.4.3 Semi-detached dwellings
- ▶ 2.4.4 Terrace style housing (defined in Woollahra LEP 2014 as either semi-detached or attached houses)
- ▶ 2.4.5 Inter-War flat buildings
- ▶ 2.4.6 Retail and commercial buildings
- ▶ 2.4.7 Corner shops
- ▶ 2.4.8 Adaptive re-use of a non-commercial building for business purposes
- ▶ 2.4.9 Adaptive re-use of commercial and industrial buildings
- ▶ 2.4.10 Places of public worship, educational establishments and public buildings
- ▶ 2.4.11 Pubs
- ▶ 2.4.12 Infill development

Most of the buildings in the Woollahra Heritage Conservation Area are identified as contributory items. A contributory item is any item that makes a contribution to the conservation area. This includes a heritage item listed in Schedule 5 of Woollahra LEP 2014 or a contributory item identified in Section C2.7 and shown in Map 2.

A contemporary design may be suitable for a contributory item where existing fabric is intrusive or of low significance. Sympathetic contemporary design may be permitted at the rear, provided:

- ▶ the proposal will achieve a cohesive relationship between new and existing fabric; and
- ▶ the designer can demonstrate that the proposal is consistent with the character of the site, the streetscape and the precinct in which it is contained.

---

### C2.4.1 Single storey residential buildings

---

Single storey residential buildings include stone, brick and weatherboard cottages and semi-detached cottages and terrace style housing. The small timber and stone cottages are significant because of their rarity and their historical association with the evolution of Woollahra particularly in the mid Victorian period. Most single storey housing is built close to their side boundaries, which limits potential additions to the rear of the building or within the roof space. Many are built to the street front whilst others have a small front garden and low masonry or picket fence.

Refer also to Section 2.4.3 for semi-detached dwellings and Section 2.4.4 for terraces.

#### Objectives

- O1 To preserve the single storey presentation of existing single storey residential buildings.
- O2 To ensure that additions to single storey buildings do not compromise or dominate the single storey setting of the principal building form.
- O3 To retain the early timber, brick and sandstone cottages, including original room layouts and roof forms of the principal building form.

#### Controls

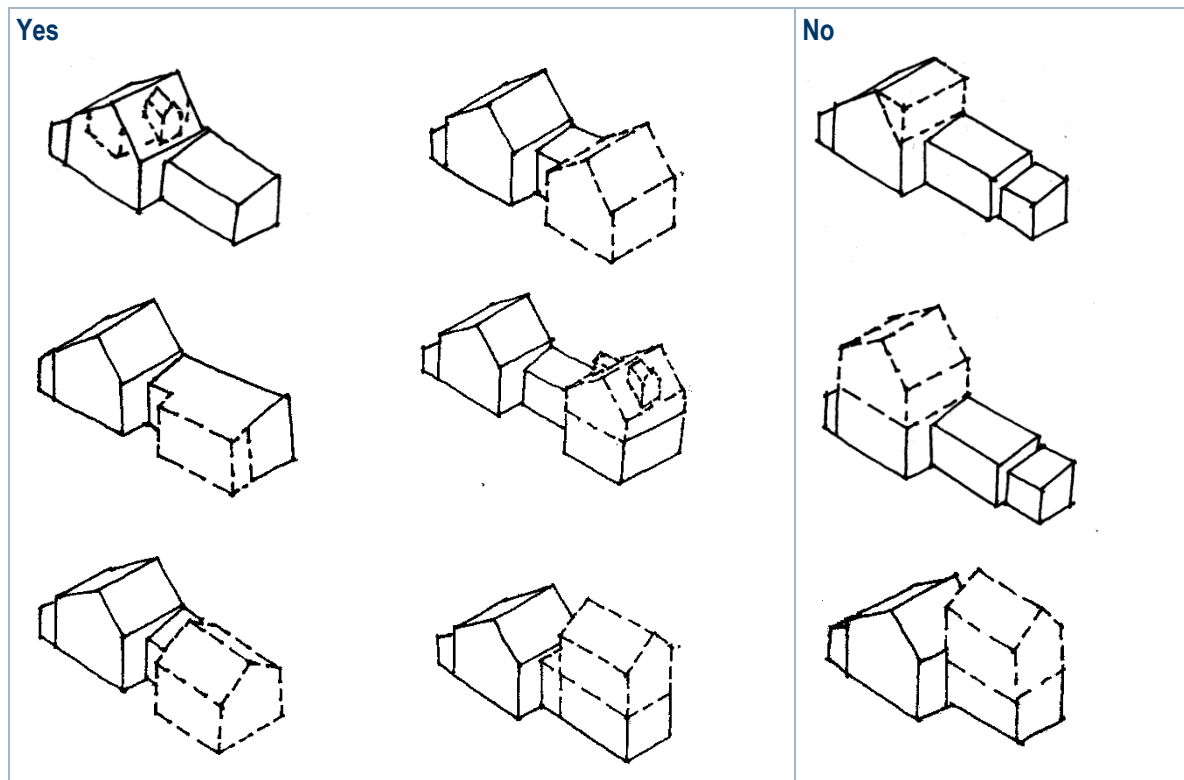
- C1 Upper floor additions to the principal building forms of single storey housing will be permitted only where the upper floor can be contained wholly within the existing roof space without change to the roof pitch or eaves height. Dormer windows may be incorporated in the rear roof plane provided they comply with the controls in Section 2.5.5.
- C2 Rear additions to single storey housing should not dominate the principal building form. The addition should have an appropriate traditional roof form that relates to the principal building form and must not exceed a height 300mm below the ridge level of the principal building.
- C3 Where additions are proposed to single storey housing, pavilion-type forms are preferred. This is unless the building belongs to a significant group and such a form would have an adverse impact on the group. The linking structure should be located below the principal eaves line, and should use lightweight construction to differentiate the new work from the original.
- C4 Boundary to boundary extensions are permitted on the ground floor level only if:
  - a) the proposal would not adversely affect the privacy, ventilation, light or amenity of the adjoining property; and
  - b) the proposal would not disrupt an existing significant pattern of a group of buildings.
- C5 Double storey additions at the rear of single storey housing are not to be visually disruptive to their setting. The two storey section should be linked by a lightweight link structure located below the eaves line of the principal building form.

- C6 Additions to contributory items must not compromise or dominate the principal building form of the building.
- C7 Upper storey additions that increase the building height of contributory items along the street frontage will not be permitted. This applies whether or not a single storey building adjoins, or is located between, contributory items of greater height.
- C8 Alterations and additions to contributory items are not to match a building that is excessive in terms of its bulk, height, scale or incompatible design.

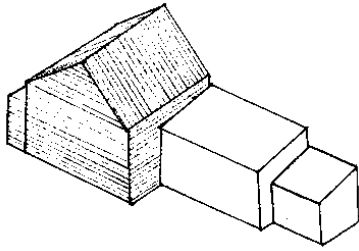
**FIGURE 1** Typical single storey housing



**FIGURE 2** Design suggestions for rear additions to single storey housing



**FIGURE 3** Single storey housing – principal building form shown hatched



### C2.4.2 Multi-storey dwelling houses

The freestanding multi-storey dwelling houses vary from small timber, stone or brick dwellings often with terrace like forms, to larger villas and houses set within landscaped gardens. They include Victorian middle class villas, large Victorian mansions built on the original estates of the gentry and the later Inter-War houses built on subsequent subdivisions.

A garden setting is usually associated with freestanding dwellings, with a fence to match the style of the dwelling. There may also be culturally significant outbuildings or landscape elements from previous estates.

#### Objectives

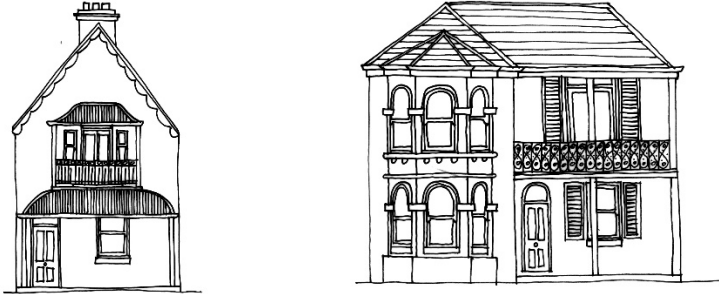
- O1 To ensure that additions to multi-storey dwelling houses do not compromise or dominate the original main front section of the house, and are suited to the architectural style of the building.
- O2 To retain the curtilage, setting and principal building form, including original layouts and roof forms of the principal building form.

#### Controls

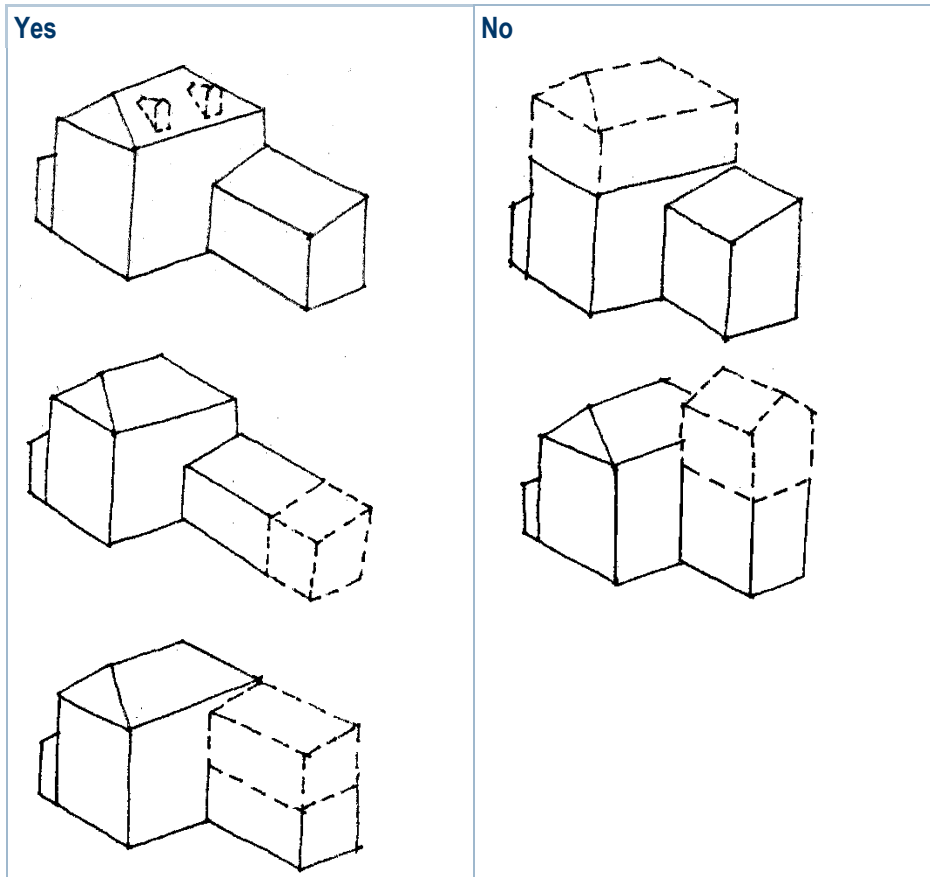
- C1 Where additions are proposed to multi-storey dwelling houses, an increase in the number of storeys will be permitted only where the upper storey can be wholly contained within the existing roof volume of the principal building form. Appropriately styled dormers may be permitted in the rear roof plane of the principal building form if not visible from the public domain.
- C2 Additional storeys may be permitted to the rear wing if an appropriate traditional roof form can be located below the gutter line of the principal building form. Additions must

not dominate the original principal building form of the house and should retain the breezeway.

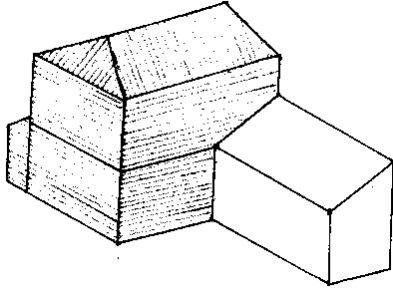
**FIGURE 4** Typical free standing multi-storey terrace dwelling houses



**FIGURE 5** Design suggestions for rear additions to multi-storey dwelling houses



**FIGURE 6** Multi-storey dwelling houses. Principal building form shown hatched.



### C2.4.3 Semi-detached dwellings

Semi-detached dwellings are usually single storey cottages built in brick with hipped or gabled roof forms and a skillion roofed wing at the rear. Rare stone and timber examples exist with simple gabled roof forms. Semi-detached dwellings are usually designed as a symmetrical pair but some asymmetrical pairs exist with a dominant roof form. These types of houses usually have a small front garden behind a picket fence or low masonry wall. Section 2.4.1 also applies to single storey semi-detached dwellings.

#### Objectives

- O1 To ensure that the original symmetrical characteristics of pairs of semi-detached dwellings are retained and enhanced.
- O2 To retain the curtilage, setting and principal building form, including original layouts and roof forms of the principal building form.
- O3 To ensure that additions are of a scale that does not dominate or compromise the principal building form.
- O4 To ensure that additions are of a scale that is compatible with the other pair in the semi-detached dwelling.

#### Controls

- C1 Alterations and additions to one house of a semi-detached pair must not compromise the uniformity and geometry of the principal or street front elevation. Alterations and additions must not dominate the other house in the pair, particularly when the other house is unaltered.
- C2 Two storey additions to the rear of a single storey wing of a semi-detached pair must be linked to the principal building form by a lightweight structure. The addition must not exceed a height 300mm below the ridgeline of the principal building form of the building.

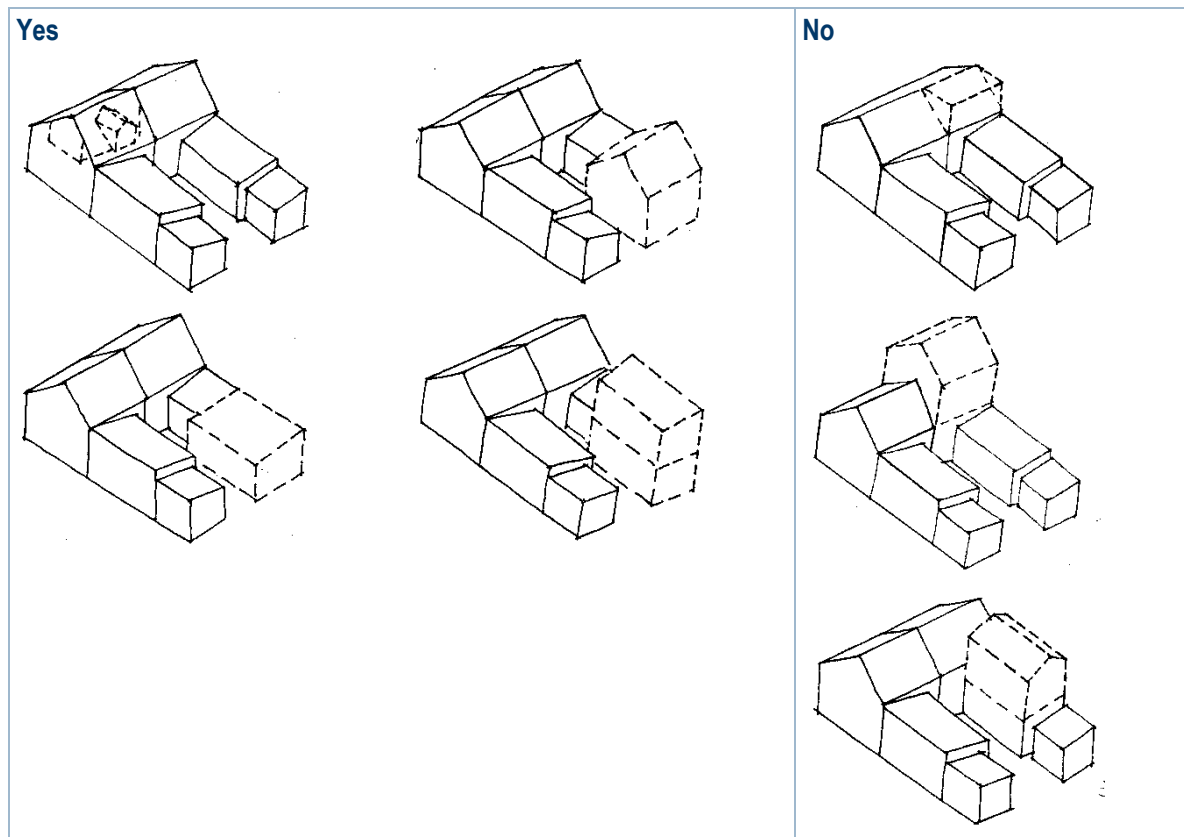


- C3 It is preferred that rear additions to single storey semi-detached dwellings include the first floor partly within the roof volume.
- C4 Additions to the rear of multi-storey semi-detached dwellings are to be limited in height to the gutter line of the principal building form.
- C5 Additions must not dominate the original principal building form of the building and should retain the breezeway.

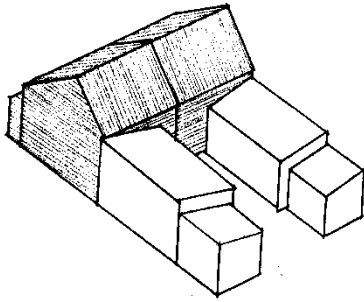
**FIGURE 7** Semi-detached dwelling types



**FIGURE 8** Design suggestions for rear additions to semi-detached dwellings



**FIGURE 9** Semi-detached dwelling. Principal building form shown hatched.



#### C2.4.4 Terrace style housing

---

Terrace housing in the Woollahra HCA is typically two storeys high, with a small front garden behind a palisade fence and a path leading to a ground floor front verandah and panelled front door. A pair of French doors at the first floor lead to an open front verandah with decorative balustrade details. A rear wing with a skillion roof of one or two storeys is common. Additional basement levels occur.

This housing was traditionally built in uniform rows; occasionally containing distinct subgroups or individual buildings within groups.

A Victorian terrace usually has painted stucco walls with a gable form roof segmented by party walls or a skillion form with a parapet to the street front. The front verandah has filigree cast iron decorative details and a separate verandah roof. Federation terraces have tuck-pointed face brickwork at the street front and turned timber fretwork and balustrades, occasionally with masonry detail.

---

## Objectives

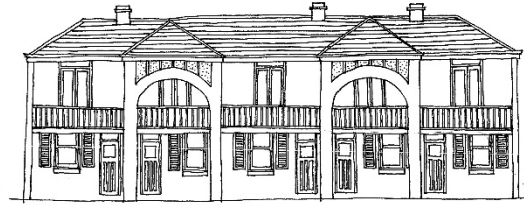
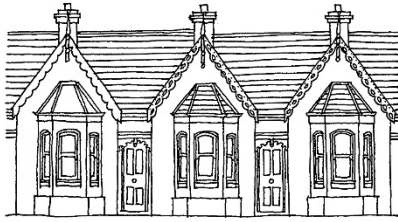
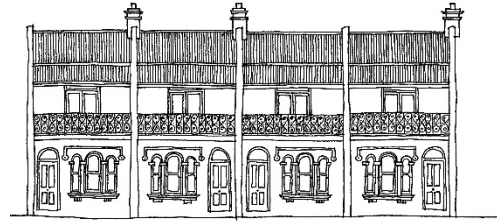
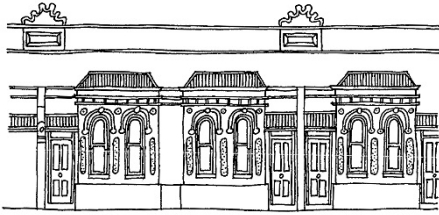
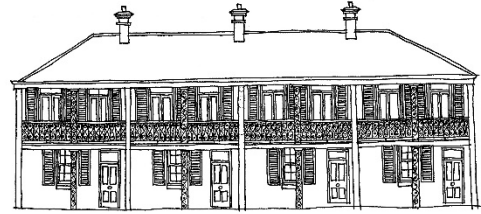
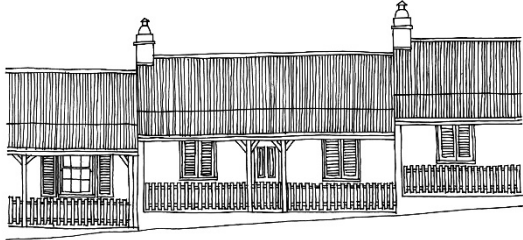
- O1 To ensure that additions to the rear of terrace buildings do not compromise or dominate the principal building form.
- O2 To retain the curtilage, setting and principal building form, including original layouts and roof forms of the principal building form.
- O3 To ensure that the original shared characteristics of a group of terrace houses are retained and enhanced.
- O4 To retain the shared distinctive characteristic of groups of buildings, including rear alignment and breezeway pattern.
- O5 To ensure that traditional side elevations, forms and alignments in corner terrace buildings are retained.

## Controls

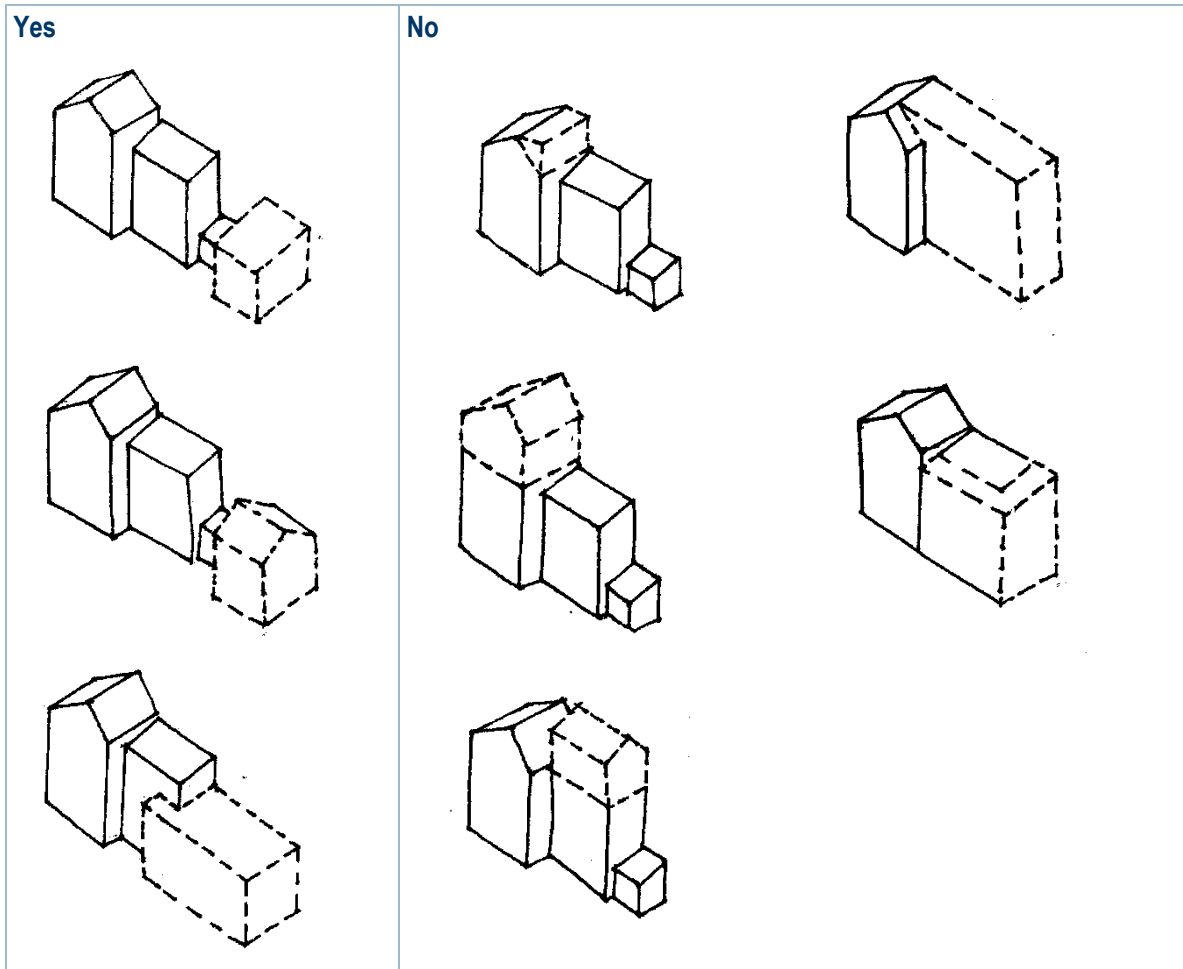
- C1 Alterations and additions to terrace houses must be consistent with the height, alignment, form, scale, breezeway pattern and architectural character of the group.
- C2 Additions to terrace houses must retain the profiles of original party walls and parapets.
- C3 Original side elevations of terraces, including side entrance doors, windows and other details are to be retained.
- C4 Minor alterations to the sides of terraces may be permitted if they do not significantly impact on the principal building form and the patterns of openings.
- C5 Additions to a terrace must not extend beyond the established rear building setback at any level of the group or row.
- C6 The overall length of any addition must be less than the length of the principal building form and must appear secondary to the principal building form.
- C7 The height of an additional storey to the rear of a single storey terrace must be 300mm below the ridgeline of the principal roof form. The linking structure should be located below the principal eaves line, and should use lightweight construction to differentiate the new work from the original.
- C8 The height of an addition to the rear of a double or triple storey terrace must be below the gutter line of the principal building form of the terrace.
- C9 Where an unaltered group of terrace houses contains single storey skillion rear forms, additions will not be permitted.
- C10 Boundary to boundary extensions are permitted on the ground floor level only, but only if:
  - c) the proposal would not adversely affect the privacy, ventilation, light or amenity of the adjoining property; and
  - d) the proposal would not disrupt an existing significant pattern of a group of buildings.

- C11 The roof of an extension or the new roof of an existing component of a terrace must be a skillion or gable form appropriate to the building type.
- C12 Additions to a terrace must retain traditional solid-to-void ratios on elevations visible from the public domain and must not incorporate large expanses of glass on the upper levels.

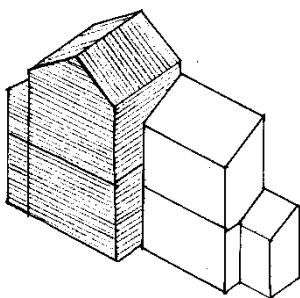
**FIGURE 10** Typical terrace house types



**FIGURE 11** Design suggestions for rear additions to terrace houses



**FIGURE 12** Terrace house. Principal building form shown hatched.



---

### C2.4.5 Inter-War flat buildings

---

The Inter-War flat buildings in the Woollahra HCA are usually three storeys high and demonstrate the influence of the Inter-War housing styles found within the Woollahra HCA. These residential flat buildings were usually built in face brickwork with contrasting decorative panels or in textured render in the Georgian Revival, Mediterranean, Spanish Mission or Old English style. Some excellent multi-storey examples of the skyscraper Gothic style within landscaped settings also exist.

There is generally little potential for additions and alterations to Inter-War flat buildings as changes usually have a negative impact on the overall character of the buildings and their settings.

Inter-War flat buildings make a contribution to the conservation area as they illustrate the evolution of Sydney's living accommodation from the single house to the acceptance of multi-unit living during the Inter-War period.

#### Objectives

- 01 To conserve and maintain Inter-War flat buildings in Woollahra.
- 02 To ensure that the significant characteristics of Inter-War flat buildings contributing to the character of the area are retained and protected.
- 03 To conserve the principal street elevations and the character of the Inter-War flat buildings.
- 04 To ensure that the character of original roofscapes, including key elements such as chimneys, is maintained.
- 05 To ensure that alterations and additions to the roofs are discreet and do not detract from the original character, proportions or key elements.
- 06 To conserve the established garden settings, including significant elements and features.
- 07 To ensure that parking does not detract from the character of the streetscape.
- 08 To ensure that external materials, details and finishes respect and complement the original building.
- 09 To ensure that works to balconies and verandahs to rear or side elevations do not detract from the character and form of Inter-War flat buildings.
- 010 To ensure that fences, gates and mailboxes are consistent with the character of Inter-War flat buildings.
- 011 To ensure that internal additions, alterations and repairs retain and respect internal common areas and significant internal character elements.
- 012 To ensure that the installation and maintenance of security devices does not detract from the character and form of Inter-War flat buildings.

- 
- O13 To ensure that fire safety and access upgrading works are discreet and retain and respect the original and significant building fabric.
  - O14 To ensure that ancillary development does not detract from the style and character of Inter-War flat buildings and their settings.
  - O15 To promote restoration and reconstruction works to restore significance.

### Controls

- C1 Significant and/or original forms, details, fabrics, materials or finishes of the principal building elevations are to be restored or reconstructed.
  - C2 Changes to the significant forms, details, materials or finishes of the principal building elevations are sympathetic to the style and period of the building.
  - C3 Alterations and additions do not impact on the overall form and character of the building, and are not visually prominent from the public domain.
  - C4 Additions are limited to undercroft areas, roof spaces and the provision of balconies.
  - C5 Alterations and additions are no higher than the existing roof level, and generally retain the original roof form of the building.
  - C6 External windows and doors are repaired or replaced to match the style, materials and finishes of the original building.
  - C7 Existing original fanlights and other openings are retained and sealed from behind, if necessary.
  - C8 Original leadlight, glass blocks, etched and patterned glazing are retained and conserved.
  - C9 Existing original external and internal doors and door hardware are retained and upgraded rather than replaced.
  - C10 New additional security elements are in character with the building. Security bars are:
    - a) fitted internally;
    - b) respect the existing glazing patterns; and
    - c) painted in a dark recessive colour.
  - C11 Original verandahs and balconies to the principal elevation of the building are not enclosed, glazed, or otherwise altered, except to reinstate original detailing.
  - C12 New verandahs and balconies are allowed to the rear or side elevations only if they:
    - a) respect the character of the existing building; and
    - b) are sympathetically integrated with the character and form of the building.
  - C13 Alterations to improve accessibility (including lifts, ramps and stairs) are sympathetically integrated with the original building and retain the original character and design of the building and landscape areas.
-



- 
- C14 Materials are similar in type and finish to those on the original building or sympathetically integrate with the fabric of the building.
- C15 Original face brickwork, terracotta or decorative concrete panels must not be painted, rendered or coated.
- C16 Dormer windows or skylights are not visually prominent from the public domain or the principal elevations of the building. Skylights are flush with the roof surface.
- C17 Original chimneys and their details are retained.
- C18 Privacy screens are discreet and do not impact on the overall character of the building.
- C19 Protruding shade structures, including awnings and canopies, are not located on the principal building elevations.
- C20 The roof maintains traditional roofing materials of the area, such as glazed terracotta tiles. Any replacement or repair matches the original roofing in type, profile, colour and materials. Concrete roofing tiles and corrugated metal roofing are not appropriate.
- C21 Internal common areas and significant character elements are retained. This includes: entry doors, foyer areas and fittings, mailboxes, noticeboards, staircases, balustrades, wall details, light fittings, internal doors and the like.
- C22 New lifts are designed and located so that the addition:
- a) is located outside the principal building form, if practical; and
  - b) does not require significant alterations to existing common areas.
- C23 Unsympathetic additions and modifications to the building, and its grounds, are to be removed and replaced with sympathetic works, or reinstatement of original forms and matching fabric.
- C24 Services upgrading and fire safety works must minimise adverse visual impact and damage to original building fabric.
- C25 Alarm bell boxes and the like, are not attached to the principal building elevations.
- C26 New or upgraded services are discreetly and sensitively located to minimise visual impact. They are located within existing ducts, behind cornices or bulkheads or within external lightwells that are not visually prominent. Wiring or other services are housed in concealed conduits.
- C27 Original timber staircases are retained and smoke isolated, if necessary.
- C28 Where the height of the original stair balustrades is to be modified – the modification is discreet and sympathetically integrated with the existing stair balustrade.
- C29 Stair treads applied to existing stairs are discreet.
- C30 Emergency and exit lighting is incorporated into existing original light fittings, where practical.
-

- 
- C31 Smoke and/or thermal detectors are discreetly located and do not impact on decorative plaster cornices and ceilings.
- C32 Car parking and garage structures are located at the rear, with access from the rear lane or side driveway.
- C33 Original fencing, gates and mailboxes are retained and conserved.
- C34 New ancillary development:
- a) is smaller in scale than the principal building;
  - b) is not located between the principal building and the street front, and generally located at the rear behind the principal building;
  - c) is constructed in a style, form, materials and finishes that complement the principal building;
  - d) is single storey with a maximum clear internal height of 2.4m; and
  - e) is sympathetic in scale and style to traditional forms of ancillary structures.
- C35 Characteristic front gardens, and their elements, are retained with minimal alteration.
- C36 Structures erected in the front garden do not significantly reduce or compromise the landscaped area or key elements and features.
- C37 New fences and gates to the front building alignment must complement the streetscape and the existing building.
- C38 Mailboxes are discreetly located and do not impact on the character of the building.

**FIGURE 13** Typical Inter-War flat building

### C2.4.6 Retail and commercial buildings

Queen Street is the primary commercial precinct in the Woollahra HCA with two and three storey buildings having shops at street level and residential above. They are typically from the Victorian or Edwardian periods with some Inter-War shops and contemporary buildings. Commercial buildings are stylistically diverse and include original shopfronts from the three main periods. Other shops are grouped on Ocean Street between Forth and Queen Streets in mid to late Victorian buildings, including some rare timber buildings. Federation period shops are grouped on Edgecliff Road, near Grafton Street. Small groups of shops are spread throughout the area.

#### Objectives

- 01 To ensure that new development within business zone reinforces the ‘main street’ character.
- 02 To ensure that the original characteristics of the retail buildings identified as contributory items are retained and enhanced, even when they have subsequently been converted for other uses.
- 03 To retain good representative examples of significant architectural styles, including original shopfronts.

---

## Controls

- C1 Retail and commercial buildings are to:
- a) be a traditional form with shops at ground level and housing or commercial spaces above;
  - b) be built to the street alignment and to side boundaries at all levels, unless the predominant character is otherwise;
  - c) be no higher than adjoining significant retail buildings. If no retail buildings adjoins, they are to be no higher than the predominant height of adjacent contributory items; and
  - d) have facades modulated into vertical proportioned bays and openings that respect the scale, proportion and architectural character of adjacent significant retail buildings.
- C2 Below the awning level of retail buildings, new work is to be consistent with the style and character of the building and the streetscape.
- C3 Except for the purposes of restoration or reconstruction, the removal or alteration of original shopfronts or elements of original shopfronts that are examples of significant architectural styles in the historical development of Woollahra are not permitted.
- C4 Where non-contributory or intrusive fabric exists in significant shopfront locations, it may be replaced by a modern shopfront if the design is consistent with historical context in terms of materials, proportions, details, colour and signage.
- C5 Contemporary designs for shopfronts must relate to the building type, streetscape and precinct. The designs should use appropriate materials and must incorporate traditional features such as the division of frontages, and the configuration of windows with stall boards and doors.
- C6 Reconstruction of original shopfronts may be appropriate in instances where a shopfront forms part of a significant group or where sufficient evidence exists to show the original shopfront design.
- C7 Shopfronts must not be amalgamated. Where properties are amalgamated, the original building elements and shopfronts must be conserved.
- C8 Modification and adaptive re-use of retail buildings must retain the original characteristics of the building type, its architectural style and context.

### C2.4.7 Corner shops

---

Corner shops are typically from the Victorian period, one or two storey high with a residence at the rear of the shop and located at cross streets and T-junctions. Often they are built to the boundary with a side shop window, an angled entry façade and a recessed entry door. Many

corner shop buildings remain but have changed in use reflecting the evolution of the suburb. Timber shop fronts are rare.

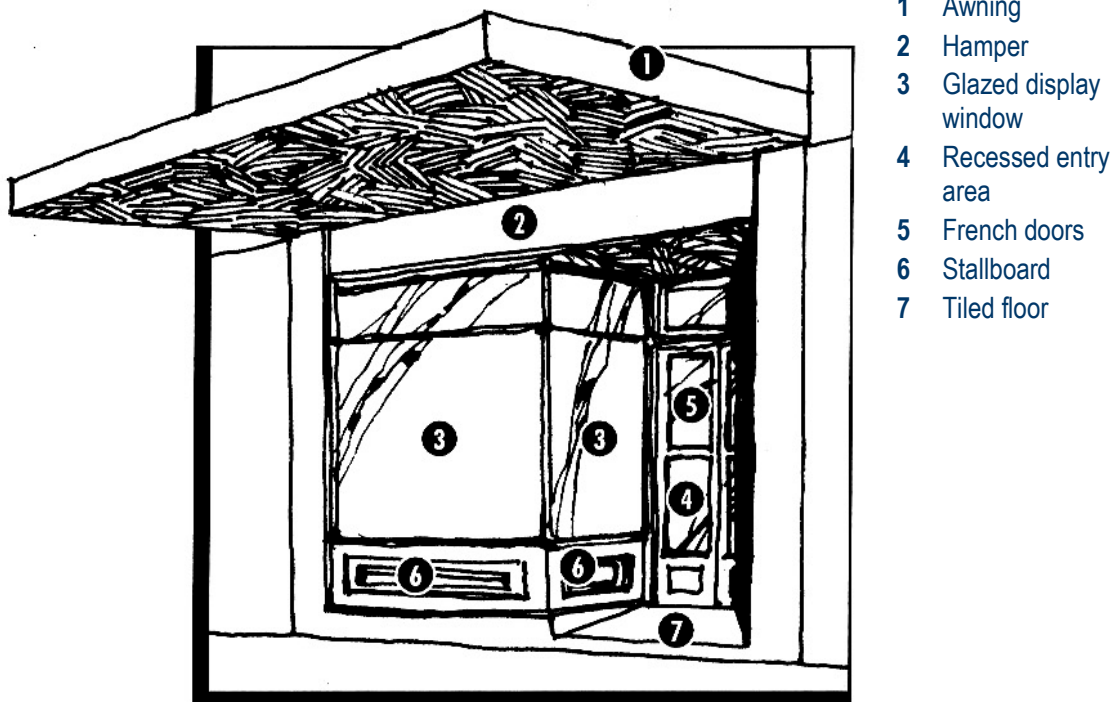
### Objectives

O1 To ensure that the original characteristics of corner shops are retained and enhanced.

### Controls

- C1 Upper storey additions to single storey corner shop buildings are not permitted.
- C2 Original forms, details, materials and finishes to corner shop buildings are to be retained when these buildings are converted for new uses.
- C3 Rear additions may be permitted if they do not compromise the form or scale of the principal building form. The retail buildings controls in Section 2.4.6 also apply.

**FIGURE 14** Traditional shopfront elements



---

### C2.4.8 Adaptive re-use of a non-commercial building for business purposes

---

Continuing development of the area has increased pressure to convert for business use buildings originally designed for residential purposes.

#### Objectives

- O1 To encourage the appropriate design of alterations to contributory items originally designed for a non-commercial function when these buildings are converted for business use.
- O2 To retain original shopfront, elevations and details of contributory items.

#### Controls

- C1 To allow for easy interpretation of the original use, adaptive re-use of contributory items originally designed for non-commercial use must retain significant interior features of the principal rooms of the original building.
- C2 Alterations to original windows to create display windows may be permitted if the original joinery characteristics are retained, the opening widths are not increased, and the symmetry of the street front elevation remains unaltered. Etched glass may be permitted within the windows.

---

### C2.4.9 Adaptive re-use of commercial and industrial buildings

---

Mostly built in the Edwardian and Inter-War periods, industrial buildings include garages, workshops, services stations and light industry factories. They are usually large volume single storey buildings constructed in brick with sheet metal roof forms. These buildings are becoming

rare and, although scattered throughout the area, are concentrated near Oxford Street and the eastern end of the Woollahra HCA.

### Objectives

- O1 To retain the original forms, details, materials and finishes of the commercial and industrial buildings listed in this chapter as contributory items, even when they have been converted for other uses.

### Controls

- C1 Adaptive re-use of contributory items originally designed for commercial or industrial use must retain significant interior features of the principal rooms of the original building to allow easy interpretation of the original use.

---

### C2.4.10 Places of public worship, educational establishments and public buildings

---

The area's churches and schools are among the most identifiable landmarks. The schools include the Woollahra Public School and the former Holy Cross College in Edgecliff Road, now Reddam College.

Churches of various denominations including the synagogues are representative works of prominent architects from the Victorian, Federation and Inter-War periods. The public buildings include the former Council Chambers, the embassies and the post office and bank buildings.

#### Objectives

- O1 To ensure that any new work is carried out with due regard to the significance of the building and its setting.

#### Controls

- C1 Council may require a conservation management plan to be prepared and adopted by Council prior to work being undertaken to a significant religious, institutional or public building.



---

## C2.4.11 Pubs

---

Most pubs in Woollahra are substantial buildings ranging in height from two to four storeys. They date from the 1840s through to the 1940s, and are prominent place markers often located on corner sites.

The pubs have an imposing presence with distinctive parapet profiles, modulated facades, window and door openings and ornate architectural detailing. Building materials include stone, brick, stucco, timber, glazed tiles and terracotta. The pubs display a diverse range of architectural styles including Victorian, Federation and Inter-war buildings. The Centennial Hotel and the Phoenix Hotel display the characteristics of the Victorian periods, while the Woollahra Hotel and the Light Brigade Hotel represent the Inter-war period. The pubs usually exhibit their façade details but few retain original interior details.

Pubs owe their survival to their ability to offer the latest in comfort, service and amenities, consistent with the demands of their customers. To meet these situations and to also comply with legislative requirements relating to matters such as trading hours and public amenity, alterations and additions to pubs occur from time to time. Despite the fact that pubs are prone to physical change, a number of Woollahra pubs remain close to their original configuration, appearance and use.

### Objectives

- O1 To conserve the diversity of pubs and their significant internal and external details associated with all periods of construction.
- O2 To retain original names of pubs as part of the historical and social significance of the Woollahra HCA.
- O3 To retain residential accommodation within pubs
- O4 To facilitate the continued role and presence of pubs in the Woollahra HCA.

### Controls

#### *Internal*

- C1 Significant interior features are to be retained.
- C2 Missing significant internal elements, details and finishes should be restored or reconstructed. These include:
  - a) decorative ceilings;
  - b) tiles;
  - c) joinery, including stairways;
  - d) fittings, including light fittings; and
  - e) traditional signs and advertising.

- C3 Original room configurations must remain discernible. Where new openings are proposed, interpretation of original wall positions and room proportions should be provided.

*External*

- C4 Original elevations must be retained and conserved.
- C5 Face brick and tiles are not to be painted over, rendered or retiled.
- C6 Significant external features are to be retained. Where appropriate, missing elements, details and finishes should be restored or reconstructed. These include:
- a) pressed metal ceilings to awnings;
  - b) awnings and balconies;
  - c) wall tiles; and
  - d) traditional signage.
- C7 The restoration of missing detail or reversal of unsympathetic work to street front elevations is required when work is undertaken to the principal elevations.
- C8 The original name of a pub must be retained and displayed appropriately in signage.
- C9 Traditional hotel signage and product advertising, such as painted glass panels advertising beer brands, should be retained, protected and displayed.
- C10 The prominence of parapets and roof lines must be retained.
- C11 The original massing and scale, pattern and modulation of facades and the proportions of openings must be retained.

---

## C2.4.12 Infill development

---

The term ‘infill’ refers to new development within an existing urban context. Infill development provides the chance for the continuing enrichment of the area by adding new built form which is an expression of contemporary life.

Replication of historical architectural styles is not necessarily advocated by Council. A contemporary design approach which respects the historic context and achieves a cohesive relationship between the existing and new urban fabric is required.

As the opportunities for infill development are rare, the design for such sites are required to demonstrate an appropriate response to context and an approach which enhances the character of the Woollahra HCA and its cultural significance.

If constructing a new building, only the building type control for infill development applies, regardless of the type of building being constructed.

### Note:

For infill development, applicants are required to provide a detailed site and context analysis.

A draft site and context analysis is to be submitted to Council for comment as part of a predevelopment application meeting between Council representatives and the applicant.

The following information is to be submitted for comment prior to the lodgement of the development application:

- ▶ the applicant’s preferred infill design proposal;
- ▶ a statement outlining the proposed measures to minimise the adverse impact of the infill development on neighbouring lands, including the public domain;
- ▶ the philosophy of how the design elements relate to the proposal’s context in terms of built form, materials and character; and
- ▶ statement of heritage impact.

### Objectives

- 01 To encourage development on infill sites which reflects contemporary values and employs contemporary design while providing an appropriate response to the historical context of Woollahra HCA.
- 02 To ensure that new development on infill sites is designed and located to achieve a cohesive relationship between new and existing urban fabric and which retains and enhances the cultural significance of the area.
- 03 To ensure that infill development respects the scale and setting of adjacent contributory items.

### Controls

- C1 Refer to the general controls in Section C2.5. These general controls apply to infill development.
- C2 If development is for a dual occupancy, the additional controls for dual occupancies in Part B, Chapter B3 General Development Controls of this DCP also apply (refer to Section B3.8 Additional controls for development other than dwelling houses) .

### *Character*

- C3 Infill development must:
  - a) maintain the significant features and qualities that combine to represent the character of the neighbourhood and area; and
  - b) make a positive contribution to the character of the neighbourhood and area.

## C2.5 General controls for all development

The general controls apply to all development including infill or replacement development (also referred to as new development), and alterations and additions to existing buildings including contributory items.

The matters addressed in this section are:

- ▶ 2.5.1 Building height, form and character
- ▶ 2.5.2 Conservation of contributory items
- ▶ 2.5.3 Conservation of contributory groups
- ▶ 2.5.4 Materials, finishes and colours
- ▶ 2.5.5 Roofs, skylights and chimneys
- ▶ 2.5.6 Open space and landscaping
- ▶ 2.5.7 Fences, gates and retaining walls
- ▶ 2.5.8 Parking and garages
- ▶ 2.5.9 Security
- ▶ 2.5.10 Excavation
- ▶ 2.5.11 Subdivision and site amalgamation
- ▶ 2.5.12 Acoustic and visual privacy
- ▶ 2.5.13 Site facilities and aerial devices

The controls in this section are to be read in conjunction with the controls in:

- ▶ Section C2.3 Precincts (where relevant); and
- ▶ Section C2.4 Building type controls.

In the event of an inconsistency with the controls in this section, the controls in Sections C2.3 and C2.4 take precedence.

Note: Included in this section are diagrams and tables to assist applicants to design in accordance with the objectives and controls of this chapter. These diagrams and tables are not intended to be exhaustive and other design options may be appropriate if they satisfy the objectives and controls.

With new development and alterations and additions to non-contributory items, there is greater scope for design flexibility provided the proposed work does not detract from the significance or character of the streetscape or the Woollahra HCA generally. The siting and alignment of buildings are important characteristics of the streetscapes of Woollahra. In most streetscapes there is a consistent pattern of similar setbacks from the street and from side boundaries.

### C2.5.1 Building height, form and character

---

The height, bulk and scale of new development and additions to existing buildings have the potential to adversely affect the amenity of private and public lands.

The controls are designed to ensure that the scale and bulk of new buildings and additions to existing buildings are compatible with:

- ▶ site conditions;
- ▶ the desired future character of the Woollahra HCA as outlined in Section 2.2.5;
- ▶ the significant characteristics of precincts described in Section C2.3, in particular the characteristics of nearby contributory items.

#### Objectives

- 01 To ensure that the established historical pattern of development is continued in terms of siting, levels and front, side and rear building setbacks.
- 02 To locate-buildings to ensure good aspect and orientation of indoor and outdoor living areas and the retention of existing trees.
- 03 To retain the patterns of height, bulk and scale distinctive to individual streetscapes and precincts.
- 04 To protect the privacy and amenity of adjoining or adjacent residential uses.
- 05 To encourage the retention or creation of useful open space at the rear of sites.
- 06 To protect and encourage views and vistas from public places, and encourage view sharing from private properties.
- 07 To minimise overshadowing of private and public open spaces.

#### Controls

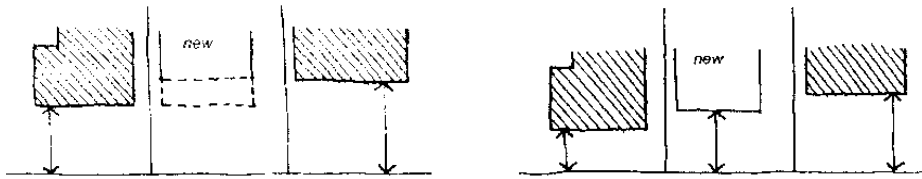
##### *Building location*

- C1 Where there are uniform levels or setbacks within the streetscape, infill development and additions to existing buildings are to be consistent with the levels and setbacks of the adjoining buildings.
- C2 Where front building setbacks vary:
  - a) if there is a dominant pattern adjoining, development is to align with that pattern. Where the pattern is stepped, development is to provide an appropriate transitional front setback between adjoining properties;

- b) if there is no predominant pattern, development is to align with the existing adjoining development which is the most compatible in scale with the proposed development. Alternatively development can be setback between the properties on either side;
- c) if development occurs on a corner site, it is to be built up to the street alignments to define the corner. Exceptions are when this interferes with views to or from the public domain or is inconsistent with the streetscape or precinct or inhibits the visibility of and for pedestrians and vehicles.

**FIGURE 15** Calculating front setbacks

Setback to be a transition between pairs of adjoining contributory items or non-contributory items (shaded)



- C3 Where buildings are orientated to face the street, development is to adopt this orientation.
- C4 Where adjoining buildings have been aligned to face a view rather than the street, development is to adopt this orientation.
- C5 The minimum landscaped area requirements and open space requirements outlined in Section 2.5.6 must be met.
- C6 The rear setback should not extend beyond the established rear building setback and must allow sufficient space for a useable private open space area and landscaped area.

#### *Building height and form*

- C7 The height, bulk, scale, dominant roof forms, ridge line and building envelope of development must be consistent with those of contributory items in the streetscape that are a similar building type. The bulk of buildings should be distributed to minimise overshadowing of adjoining properties. In circumstances where the infill site adjoins a prominent building or a building of excessive height or intrusive design, conformity is not appropriate.
- C8 The character of development is to be consistent with the character of nearby contributory items and of the streetscape. Solid to void ratios of elevations are to be similar to those of nearby contributory items.
- C9 Storey heights must conform to those of adjacent contributory items. Three storeys may be permitted if the predominant contributory items in the streetscape are three storeys or more.

- C10 Development is not to obstruct views or vistas from the public domain:
- a) along streets;
  - b) towards the harbour, city or local landscape; and
  - c) across the Woollahra HCA to landmark buildings, trees or skylines.
- C11 Development must not unreasonably obstruct existing principal views from the habitable rooms, balconies and private open space of neighbouring dwellings.
- C12 If development is in the form of a dual occupancy, the additional controls for dual occupancies in Part B, Chapter B3 General Development Controls of this DCP also apply (refer to Section B3.8 Additional controls for development other than dwelling houses) .

*Solar access and ventilation*

- C13 Sunlight is provided to at least 50% (or 35m<sup>2</sup> with minimum dimensions 2.5m, whichever is smaller) of the main ground level private open space of adjacent properties for a minimum of two hours between 9am and 3pm on 21 June. Where existing overshadowing is greater than this, sunlight is not further reduced.
- C14 Windows to north facing habitable rooms receive at least 3 hours of sun between 9am and 3pm on 21 June over a portion of their surface.
- C15 For residential flat buildings containing four or more dwellings:
- a) not more than 25% of all dwellings should be single aspect;
  - b) single aspect dwellings should be limited in depth to 8m from a window;
  - c) the back of a kitchen should be no more than 8m from a window; and
  - d) the width of cross-over or cross-through dwellings over 15m deep should be 4m or greater to avoid deep, narrow dwelling layouts.



---

## C2.5.2 Conservation of contributory items

---

### Objectives

- O1 To retain the original built form characteristics of contributory items.
- O2 To ensure that contributory items, their outbuildings and their curtilages and settings are retained.
- O3 To retain the original building elements of contributory items and, where original elements are missing, to encourage their reinstatement.
- O4 To ensure that alterations and additions to contributory items incorporate building elements that are compatible with traditional built forms and do not adversely affect the heritage significance of the building or its surroundings.
- O5 To ensure alterations or additions to a contributory item are designed:
  - a) to be consistent with the original architectural style, form, massing, details, materials and finishes of the item; and
  - b) not to have an adverse impact on the curtilage and setting of the item.
- O6 To ensure that the various heights and setbacks of contributory items within the streetscape are retained.

### *Contributory items - additional built form controls*

#### *General*

- C1 Contributory items are to be retained and conserved, that is:
  - a) their significant fabric is to be retained;
  - b) original principal building forms, including roof pitch, eaves height and chimneys, are to be retained;
  - c) except to allow for restoration or reconstruction, no alterations or additions are to be made to the original elevations, details, materials or finishes of the principal building form;
  - d) original verandahs and balconies are not to be infilled or enclosed; and
  - e) original room layouts of the principal building forms are to be retained.
- C2 When proposing works to the principal building form, original external elevations roof, curtilage or setting of contributory items:
  - a) missing or damaged original forms, details, materials and finishes are to be restored or reconstructed. Reconstruction is to be based on research rather than conjecture; and
  - b) inappropriate or intrusive forms, details, materials and finishes are to be removed.

*Internal modifications*

- C3 Partial demolition of internal cross walls to the principal building form will only be permitted where:
- a) the original room layouts are able to be interpreted;
  - b) the main rear wall to the principal building form remains;
  - c) the structural integrity of the building and its adjoining buildings are not compromised; and
  - d) there is no increase in light levels at the front windows when viewed from the public domain.
- C4 Decorative coffered ceilings to the rooms located within the principal roof form are not to be removed to incorporate an additional storey within the existing roof form.

### C2.5.3 Conservation of contributory groups

---

Where a building belongs to a group of similar items, it is important that alterations and additions do not compromise the character of the group as a whole. The original consistency of the street

---

front elevation should be retained and conserved, and so should that of side and rear elevations where these are visible from the street or other public places.

### Objectives

- O1 To ensure that the distinctive shared characteristics of significant groups of buildings are retained and enhanced.
- O2 To ensure that alterations and additions within a significant group conform to the shared characteristics of the group and do not compromise its integrity.

### Controls

- C1 The distinctive original shared characteristics of a significant group of buildings are to be retained, including:
  - a) existing patterns of principal roof forms within unaltered groups of contributory items;
  - b) secondary or rear forms, which must not be raised or altered if the rear forms are part of a group of similar roof forms.
- C2 Where a building is one of a group of similar attached contributory items, the design of additions must:
  - a) not compromise or dominate the group as a whole;
  - b) be consistent with the form and pattern of original roof forms of the adjoining contributory items;
  - c) be consistent with the form, symmetry, breezeway pattern and rhythm of the original rear wings of the group as a whole and must not visually disturb the cohesiveness of the group; and
  - d) elevations should have solid to void ratios that are consistent with the group.
- C3 Intact or largely intact side elevations of buildings in significant group items joined by party walls are to be retained in their original configuration where these are visible from the public domain. Minor alterations to parts of these side elevations may be permitted if they do not impact significantly on the original architectural form of the elevation or the pattern or proportion of openings.
- C4 Where works are proposed to individual buildings within a significant group, missing or damaged original forms, details, materials and finishes are to be restored or reconstructed to reinstate the original shared characteristics of the group as a whole, particularly where visible from the public domain. Exceptions may be allowed where the original forms, details, materials or finishes of the entire group have previously been changed and reinstatement of the original would disturb the cohesiveness of the group.
- C5 Where buildings in a significant group share the same original external finish all buildings within the group must have a similar finish.

---

### C2.5.4 Materials, finishes and colours

---

Buildings in the Woollahra HCA have been constructed in a variety of external materials, finishes and colours characteristic of particular architectural styles, building types and periods of construction.

The use of modern materials and finishes may be appropriate for new development, alterations and additions provided it does not compromise a cohesive relationship between new and existing urban fabric.

Table 1 following lists materials and finishes suitable for infill development and alterations and additions. It also lists materials and finishes that are intrusive elements, whether by their nature or if used in inappropriate situations.

The great variety in form and detail of roofs, windows, shutters and external doors in the Woollahra HCA makes a significant contribution to the architectural complexity of the area as a whole.

The styles of these important building components are strongly related to the architectural style and period of construction of the buildings to which they belong. Late 19th century and early 20th century windows were usually rectangular in shape and vertically proportioned. Where a larger opening was desired, windows were set in groups. Many buildings obtain visual interest from verandahs and balconies, which create a strong pattern of light and shade by their projection, covering roof and detail decoration.

#### Objectives

O1 To achieve external materials, finishes and colour schemes appropriate to the context.

#### Controls

- C1 Materials, finishes, textures and colours must be appropriate to the building type and style. They must be similar to, but should not copy, the characteristic materials, finishes, textures and colours of the contributory items within the streetscape. Contemporary materials may be used where their proportions, detailing and quantities are consistent with the existing and desired future character of the precinct. New development must minimise its visual impact on the surroundings.
- C2 External detailing, colour and finishes must minimise the apparent bulk of new development.

---

*Significant Items - original materials, finishes and colours*

**Objectives**

- O2 To retain and conserve original external finishes and colour schemes to buildings within the Woollahra HCA.
- O3 To encourage finishes and colour schemes of additions to contributory items to be appropriate to the building type, architectural style and construction period.

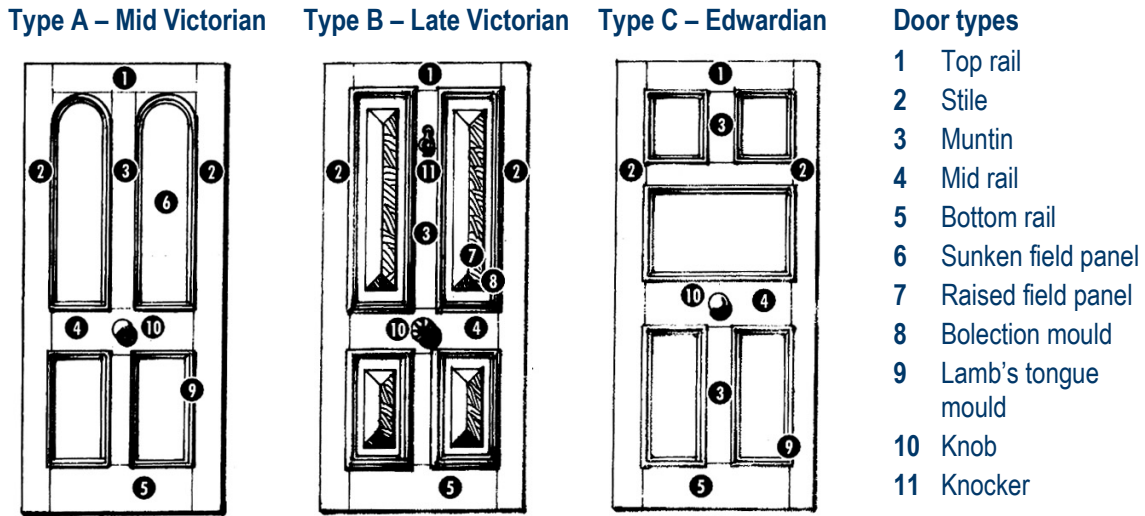
**Controls**

- C3 Surviving original external finishes and colour schemes of street front elevations, secondary elevations and building components of contributory items are to be retained and conserved.
- C4 Any works must not damage or remove the original materials of a contributory item or place within the Woollahra HCA. Unpainted brickwork, sandstone, terracotta, glazed or tessellated tiling are not to be painted, rendered, bagged or otherwise re-finished in a manner inappropriate to the architectural style of the building.
- C5 External finishes to additions to contributory items must complement the architectural style of the existing building.
- C6 External colour schemes of contributory items should have hue and tonal relationships similar to those of traditional colour schemes, although it is not necessary that they be finished in a 'heritage' colour scheme.

*Contributory items - windows, shutters and doors*

- C7 Original windows, shutters and external doors to contributory items must not be removed except to allow for their conservation and maintenance.
- C8 Where replacement windows, shutters and external doors are proposed original openings should be utilised. Materials and details are to match the original where this is known; otherwise it should be appropriate to architectural style, building type and construction period.
- C9 External shutters are not to be added to original windows and doors of contributory items unless they were features of the original design of the building.
- C10 Windows, shutters and external doors to additions to contributory items are to be designed with contemporary detailing and materials appropriate to the architectural style of the existing building and the proportions of its openings. The height of a new window must be greater than 1.4 times the width and less than twice the width.

**FIGURE 16** Some common examples of front doors are shown. All are panelled doors with stiles and rails. Type A and B are four panel doors, while Type C is a high-waisted Edwardian door.



*Contributory items - Verandahs and balconies*

- C11 Original verandahs and balconies are not to be altered except for the reinstatement of original details and the reversal of unsympathetic alterations.
- C12 Where evidence shows that they have previously existed on street front elevations, verandahs and balconies may be reinstated using traditional materials and details.
- C13 The addition of balconies to the roofs of contributory items will not be permitted except where Juliette balconies may be permitted by C20 in Section 2.5.5.
- C14 The step down from the main roof to the verandah roof must be retained or reinstated where a new or replacement or reinstatement of a verandah on the street front elevation is proposed.

**FIGURE 17** Typical Victorian terrace verandah elements



**TABLE 1** Design controls external finishes

ROOFS		
	Traditional materials	Preferred replacements
<b>Victorian</b>	<ul style="list-style-type: none"> <li>▶ Welsh or South Australian slate.</li> <li>▶ Late Victorian houses occasionally had traditional ornamental patterns.</li> </ul>	<ul style="list-style-type: none"> <li>▶ Slate or slate-like cladding incorporating ornamental patterns where these existed originally.</li> <li>▶ Corrugated galvanised steel or zinc coated corrugated steel may be appropriate in some cases.</li> </ul>
	<ul style="list-style-type: none"> <li>▶ Corrugated iron in shorter, narrower sheets than are standard today.</li> </ul>	<ul style="list-style-type: none"> <li>▶ Corrugated galvanised steel or zinc coated corrugated steel with traditional details and fixings.</li> </ul>
<b>Federation</b>	<ul style="list-style-type: none"> <li>▶ Slate with terracotta ridge capping and decorative detailing.</li> </ul>	<ul style="list-style-type: none"> <li>▶ Slate with terracotta detailing to match existing.</li> <li>▶ Corrugated galvanised steel or zinc coated corrugated steel.</li> </ul>
	<ul style="list-style-type: none"> <li>▶ Unglazed terracotta roof tiles in Marseilles pattern, often with ridge cappings and decorative detailing.</li> </ul>	<ul style="list-style-type: none"> <li>▶ Unglazed terracotta roof tiles in Marseilles pattern to match existing.</li> </ul>
	<ul style="list-style-type: none"> <li>▶ Corrugated iron.</li> </ul>	<ul style="list-style-type: none"> <li>▶ Corrugated galvanised steel or zinc coated corrugated steel.</li> </ul>
<b>Inter-War</b>	<ul style="list-style-type: none"> <li>▶ Terracotta tiles of Marseilles, Roman or Spanish pattern, depending on architectural style.</li> <li>▶ Coloured or glazed. Terracotta shingle tiles.</li> </ul>	<ul style="list-style-type: none"> <li>▶ Terracotta tiles or shingles to match existing or appropriate to the style of the building if original tiles have been removed.</li> </ul>
<b>Roofing material controls</b>		
<b>New roofs to additions to contributory items</b>	<ul style="list-style-type: none"> <li>▶ Traditional roofing materials outlined above appropriate to the style of the building.</li> <li>▶ Matching original materials to the original part of the building may be the most appropriate.</li> </ul>	
<b>Infill development</b>	<ul style="list-style-type: none"> <li>▶ Metal roofing visible from the public domain is to be traditional corrugated profile. Natural metallic finish or a pre-coloured mid or dark grey metal sheeting is preferred.</li> </ul>	

ROOFS	
<b>Intrusive</b>	<ul style="list-style-type: none"> <li>▶ Concrete roof tiles.</li> <li>▶ Metal roofing sheets brightly coloured, white or ivory, or colours in light tones.</li> <li>▶ Metal sheeting with tray profiles.</li> <li>▶ Roof tiles on Victorian buildings.</li> </ul>

WALLS		
	Traditional materials	Preferred replacements
<b>Victorian</b>	<ul style="list-style-type: none"> <li>▶ Sandstone blocks for walls or as a base course to brick walls.</li> <li>▶ Brickwork, usually rendered, often with ashlar coursings.</li> <li>▶ Corrugated galvanised iron.</li> </ul>	<ul style="list-style-type: none"> <li>▶ Conservation of sandstone required.</li> <li>▶ Replacement brickwork with materials having matching finishes.</li> <li>▶ Corrugated zinc coated corrugated steel with traditional details and fixings.</li> </ul>
<b>Victorian and Federation</b>	<ul style="list-style-type: none"> <li>▶ Timber weatherboards.</li> <li>▶ Zinc coated corrugated steel or ripple iron and weatherboards on sides of dormers and outbuildings.</li> </ul>	<ul style="list-style-type: none"> <li>▶ Timber weatherboards.</li> <li>▶ Corrugated zinc coated corrugated steel with traditional details and fixings.</li> </ul>
<b>Federation</b>	<ul style="list-style-type: none"> <li>▶ Face brickwork with tuck pointing on principal facades, often with sandstone, terracotta or contrasting brick details.</li> <li>▶ Brickwork rendered with stucco decorations or areas of rough cast render.</li> </ul>	<ul style="list-style-type: none"> <li>▶ Dry pressed bricks with appropriate pointing of joints and conservation of contrasting materials.</li> <li>▶ Rendered brickwork.</li> </ul>
<b>Inter-War</b>	<ul style="list-style-type: none"> <li>▶ Face brick, often textured and with contrasting panels.</li> </ul>	<ul style="list-style-type: none"> <li>▶ Conservation preferred, or replacement bricks with appropriate pointing of joints.</li> </ul>



WALLS	
Walling material controls	
<b>New walls to additions to existing buildings</b>	<ul style="list-style-type: none"> <li>▶ Rendered brickwork or blockwork, with or without scribed ashlar coursing where appropriate.</li> <li>▶ Timber weatherboards.</li> <li>▶ Dark coloured dry-pressed brick with a smooth face.</li> </ul>
<b>Infill development</b>	<ul style="list-style-type: none"> <li>▶ Fibrous cement sheeting with a rendered and painted finish - for rear additions.</li> </ul>
<b>Intrusive</b>	<ul style="list-style-type: none"> <li>▶ Circular pattern render (mock Spanish) or rough textured render (unless to match an original finish to the building).</li> <li>▶ Inappropriately textured or modern colour brickwork.</li> <li>▶ Textured fibrous cement sheeting simulating weatherboard textures.</li> <li>▶ Reflective wall cladding.</li> </ul>

WINDOWS		
	Traditional materials	Preferred replacements
<b>Victorian</b>	<ul style="list-style-type: none"> <li>▶ Timber framed, double hung sash windows, plain or multi-paned.</li> <li>▶ Plain glass, traditional patterns or coloured glass.</li> </ul>	<ul style="list-style-type: none"> <li>▶ Timber frames of a matching type and configuration.</li> <li>▶ Coloured and patterned glass may be appropriate for replacement windows at the front of buildings, otherwise glazing to be plain.</li> </ul>
<b>Federation</b>	<ul style="list-style-type: none"> <li>▶ Timber framed, double hung sash or casement windows, often with multi-paned coloured glass in part.</li> </ul>	<ul style="list-style-type: none"> <li>▶ Match original window materials and configuration.</li> <li>▶ Coloured and patterned glass may be appropriate for replacement windows generally at the front of buildings, otherwise glazing to be plain.</li> <li>▶ Metal frames to ground floor shops and commercial premises where appropriate.</li> </ul>

WINDOWS		
<b>Inter-War</b>	<ul style="list-style-type: none"> <li>▶ Timber framed, usually double hung sashes often in combination with fixed panels.</li> <li>▶ Steel framed, usually casements, often in combination with fixed panels.</li> <li>▶ Leadlight glass common.</li> </ul>	<ul style="list-style-type: none"> <li>▶ Match original window materials and configuration.</li> <li>▶ Metal frames to ground floor shops and commercial premises where appropriate.</li> </ul>
<b>Window material controls</b>		
<b>Alterations to contributory items</b>	<ul style="list-style-type: none"> <li>▶ Window frames in the traditional material of the original type, but of contemporary design which respect the architectural style of the building.</li> <li>▶ A single new window located in a wall which otherwise only has original windows, should be detailed similarly to the original windows, but with plain glass.</li> <li>▶ Alterations are proposed to the rear of a building and the rear elevation has already been substantially altered, windows of contemporary design may be acceptable and even preferable, using similar proportions appropriate to the original building type.</li> <li>▶ Metal frames for ground floor shops and commercial premises where appropriate.</li> </ul>	
<b>Intrusive</b>	<ul style="list-style-type: none"> <li>▶ Timber windows in metal frames not reflecting traditional proportions other than at rear ground levels, shops and commercial premises.</li> <li>▶ Glass block infill where glass blocks were not an original component of the building.</li> <li>▶ Bubble glass.</li> <li>▶ Tinted or reflective glass.</li> <li>▶ Aluminium windows other than rear ground floor and shops to commercial premises where appropriate.</li> <li>▶ Window walls.</li> <li>▶ Replica copies in aluminium of traditional balustrade patterns used as security screens on windows.</li> </ul>	

SHUTTERS	
Traditional materials	Preferred replacements

SHUTTERS		
<b>Victorian</b>	<ul style="list-style-type: none"> <li>▶ Timber louvres.</li> <li>▶ Expanding concertina style metal shutters to shopfronts.</li> </ul>	▶ Match original materials and configuration.
<b>Federation</b>	<ul style="list-style-type: none"> <li>▶ Timber louvres.</li> <li>▶ Expanding concertina style metal shutters to shopfronts.</li> </ul>	▶ Match original materials and configuration.
<b>Inter-War</b>	▶ Timber louvres with motifs to match the architectural style.	▶ Match original materials and configuration.
<b>Shutter material controls</b>		
<b>New shutters to contributory items</b>	<ul style="list-style-type: none"> <li>▶ Replacement shutters should be of materials and details similar to the original shutters, but should be identifiable on close inspection as new work.</li> <li>▶ Dark hued traditional concertina security shutters on the inside of shop windows and externally to doors.</li> </ul>	
<b>Intrusive</b>	▶ Roller shutters to windows or doors to residential buildings, retail and commercial premises internally or externally mounted.	

DOORS		
	Traditional materials	Preferred replacements
<b>Victorian</b>	<ul style="list-style-type: none"> <li>▶ Principal doors: timber solid core, panelled with timber, etched or frosted glass.</li> <li>▶ Secondary doors ledged and braced.</li> </ul>	▶ Match original materials, proportions and configuration.
<b>Federation</b>	▶ Timber panelled doors with small coloured glass or lead lights.	▶ Match original materials, proportions and configuration.
<b>Inter-War</b>	▶ Timber solid core doors with metal decorative features or with glazed panels, often with leadlights.	▶ Match original materials, proportions and configuration.
<b>Door material controls</b>		

<p><b>New doors to original openings to contributory items</b></p>	<ul style="list-style-type: none"> <li>▶ Joinery shop solid core framed and panelled timber doors detailed similarly to original doors, but identifiable on close inspection as new work.</li> <li>▶ Solid core timber framed doors, glazed timber framed doors, glazed steel frame in appropriate locations, depending on architectural style.</li> </ul>
<p><b>Alterations to contributory items</b></p>	<ul style="list-style-type: none"> <li>▶ New door or doors to a wall which otherwise only includes original doors, should be detailed similarly to the original doors, and be of the same material.</li> <li>▶ Alterations to the rear of a building where the rear elevation has already been substantially altered, doors of contemporary design may be acceptable and even preferable, using similar materials and proportions.</li> <li>▶ Plain glass should be used.</li> </ul>
<p><b>Additions to contributory items</b></p>	<ul style="list-style-type: none"> <li>▶ Timber or steel framed doors of contemporary design which respect the architectural style of the building, the materials to be consistent with the style of the building.</li> <li>▶ Aluminium or metal framed doors to ground floor shops and commercial premises only where appropriate.</li> <li>▶ Plain glass should be used.</li> </ul>
<p><b>Intrusive</b></p>	<ul style="list-style-type: none"> <li>▶ Fully glazed doors, or enlarged doors to the street front elevations of contributory items where these were not original to the building.</li> <li>▶ Roller shutter doors to residential buildings, retail and commercial premises.</li> <li>▶ Anodised aluminium security doors, particularly with decorative panels.</li> </ul>

<p><b>VERANDAHS</b></p>	
<p><b>Traditional materials</b></p>	<p><b>Preferred replacements</b></p>

VERANDAHS		
<b>Victorian</b>	<ul style="list-style-type: none"> <li>▶ Floors of stone flagging, marble, unglazed multi-coloured tessellated tiles.</li> <li>▶ Timber for floors and timber framing for the underside of verandah roofs.</li> <li>▶ Slate, timber and sandstone edging.</li> <li>▶ Cast iron posts of a flat profile or circular in section, cast iron friezes, balustrades and brackets.</li> <li>▶ Corrugated iron or slate roof, separated from the main roof form.</li> </ul>	<ul style="list-style-type: none"> <li>▶ Match original material type, proportions and configuration.</li> </ul>
<b>Federation</b>	<ul style="list-style-type: none"> <li>▶ Timber filigree timber post, flooring and timber filigree balustrades and fretwork.</li> <li>▶ Corrugated iron, slate, shingled or metal or terracotta tiles to roof.</li> </ul>	<ul style="list-style-type: none"> <li>▶ Match original material type, proportions and configuration.</li> </ul>
<b>Inter-War</b>	<ul style="list-style-type: none"> <li>▶ Usually a loggia rather than a verandah. Often semi enclosed with stone flagging, tiles or terrazzo flooring.</li> </ul>	<ul style="list-style-type: none"> <li>▶ Match original material type, proportions and configuration.</li> </ul>
<b>Verandah material controls</b>		
<b>New verandahs or reconstruction</b>	<ul style="list-style-type: none"> <li>▶ Traditional materials for reconstruction.</li> <li>▶ Materials similar to traditional materials for infill but with simplified detailing.</li> </ul>	
<b>Intrusive</b>	<ul style="list-style-type: none"> <li>▶ Infilling of open wall with glazing or solid panels.</li> <li>▶ Glazing behind balustrades.</li> <li>▶ Pebble-crete, modern concrete, large scale modern tiles for original building types.</li> <li>▶ Perspex or similar type material roofs.</li> <li>▶ Glass roofs to street facades.</li> </ul>	

BALCONIES		
	Traditional materials	Preferred replacements
<b>Victorian</b>	▶ Cast iron friezes and balustrade panels with iron or timber handrails.	▶ Match original material type, proportions and configuration.
<b>Federation</b>	▶ Timber balustrades and brackets.	▶ Match original material type, proportions and configuration.
<b>Inter-War</b>	▶ Open balconies with concrete floors, often with tessellated tiles and decorative wrought iron balustrades.	▶ Match original material type, proportions and configuration.
Balcony material controls		
<b>New balconies to contributory items</b>	▶ Traditional materials for reconstruction on original building types or with modern material equivalents.	
<b>Infill development</b>	▶ Masonry, timber or metal balustrades.	
<b>Intrusive</b>	▶ Smooth, textured or profiled face brick and exposed cement blocks. ▶ Corrugated and other profiled metal sheeting. ▶ Wire fencing. ▶ Fibrous cement sheeting.	

FENCES		
	Traditional materials	Preferred replacements
<b>Victorian</b>	<ul style="list-style-type: none"> <li>▶ Occasionally rendered masonry with inscribed ashlar coursing.</li> <li>▶ Timber post, rail and paling.</li> <li>▶ Iron palisade, sometimes on sandstone bases.</li> <li>▶ Timber pickets.</li> </ul>	<ul style="list-style-type: none"> <li>▶ Match original material type, height, proportions and configuration.</li> <li>▶ Iron palisades to be cast to match if reconstructing from known details.</li> <li>▶ Timber pickets to have simple acute angled tops rather than imitation pickets.</li> </ul>
<b>Federation</b>	<ul style="list-style-type: none"> <li>▶ Brick, often with dwarf walls and pillars with decorative wrought iron panels or decorative timber paling.</li> </ul>	<ul style="list-style-type: none"> <li>▶ Match original material type, height, proportions and configuration or replace with similar material with simplified contemporary details.</li> </ul>
<b>Inter-War</b>	<ul style="list-style-type: none"> <li>▶ Brick, usually with contrasting panels or brickwork or wrought iron to match the style of the building.</li> </ul>	<ul style="list-style-type: none"> <li>▶ Match original material type, height, proportions and configuration.</li> </ul>
Fence material controls		
<b>New fences to contributory items and infill development</b>	<ul style="list-style-type: none"> <li>▶ Traditional material type and transparency but with simplified contemporary details to suit building style, height and context such as vertical steel pickets with tapered tops for palisade fencing.</li> <li>▶ Contemporary interpretation of traditional metal decorative details but not aluminium versions.</li> </ul>	
<b>Intrusive</b>	<ul style="list-style-type: none"> <li>▶ Smooth, textured or profiled face brick and exposed cement blocks.</li> <li>▶ Full height solid brick fences.</li> <li>▶ Materials and forms that are inappropriate to the style of the building.</li> <li>▶ Aluminium versions of palisade pickets or wrought iron details.</li> </ul>	

---

### C2.5.5 Roofs, skylights and chimneys

---

Roof forms and details in the Woollahra HCA vary widely according to building type and architectural style and this variety of forms makes an important contribution to the aesthetically significant visual complexity of the area as a whole.

#### Objectives

- O1 To ensure new roofs and alterations to roofs fit in with the character, physical context and historical background of the streetscape, precinct and HCA as a whole.

#### Controls

- C1 Where new development adjoins a contributory item, roof forms and cladding are to be consistent with those of the contributory item.
- C2 No rear roof plane is to incorporate more than 25% transparent material including skylights and dormers.

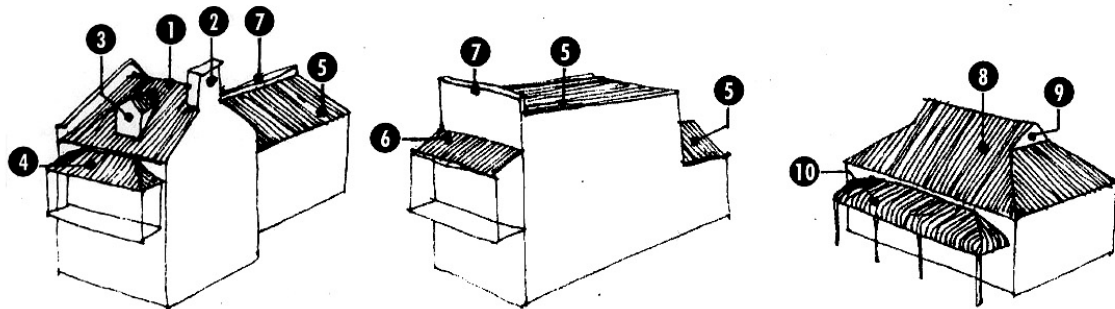
#### Skylights

- C3 Skylights to the front or side of a building are not to be located where they would be visible from the public domain.
- C4 Skylights must have a low profile and must be flush with the roof surface. They should be predominantly of glass, with simple, unobtrusive detailing. The frame colour must match the surrounding roof colour.

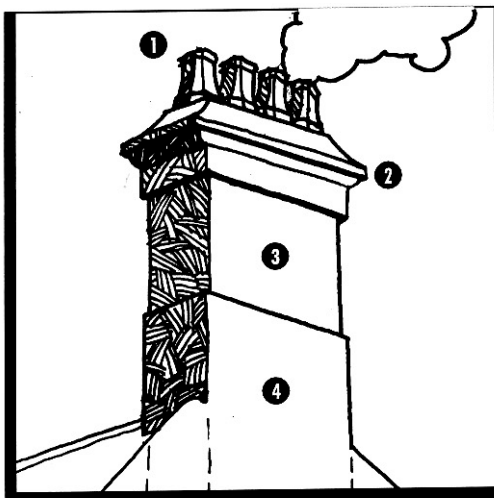
#### *Contributory items - roofs and chimneys*

- C5 The original forms, materials, finishes and details to the roofs and chimneys of contributory items are not to be removed, except to allow for their conservation and maintenance. Additions at the rear are to retain all existing chimneys.
- C6 When original roofing materials to contributory items are deteriorated, they are to be replaced by the same or similar materials and details. Gutters and downpipes are to be of traditional profiles and materials.
- C7 When a building has been re-roofed with inappropriate materials and the roofing is to be replaced, cladding and details are to be the same or similar to original materials appropriate to the architectural style, building type and construction period of the building, except where changing the roofing material would have an adverse impact on a significant group as a whole.
- C8 Additions to contributory items are to have traditional roof forms clad in traditional materials appropriate to the style of the building.



**FIGURE 18** Traditional roof elements

- |                       |                            |
|-----------------------|----------------------------|
| 1 Gable roof          | 6 Skillion balcony roof    |
| 2 Chimney stack       | 7 Parapet                  |
| 3 Dormer              | 8 Hipped roof              |
| 4 Hipped balcony roof | 9 Gablet                   |
| 5 Skillion roof       | 10 Bullnosed verandah roof |

**FIGURE 19** Typical chimney stack

- |                             |
|-----------------------------|
| 1 Chimney pot               |
| 2 Coped and moulded cornice |
| 3 Shaft                     |
| 4 Stump                     |

### *Contributory Items - dormers*

- C9 Dormer windows will not be permitted to street front elevations of contributory items or to the parts of side elevations visible from the public domain. Exceptions may be made if physical or documentary evidence shows that a dormer or dormers existed in these locations as part of the original design of the building.
- C10 A dormer or dormers may be inserted into the rear roof plane of a contributory item or to the roof of an additional pavilion form if this would have negligible impact on the heritage significance of the building or, where appropriate, of the significant group.

- C11 Where new dormer windows are permitted to contributory items or their additions, the design, proportions and materials must be based on traditional models. They must be appropriate to the architectural style, building type and construction period of the building as well as the historical background and physical context of the precinct.

*Dormers to Victorian period cottages, semi-detached dwellings and terraces*

- C12 A single dormer must not exceed one third of the width of the roof or 1500mm, whichever is less.
- C13 More than one dormer window may be located within the rear slope of the main roof of a contributory item if the width of the roof is greater than 6m. This is subject to consideration of the impact on the heritage significance of the item and, where appropriate, of the significant group.
- C14 The height of a dormer window, excluding its pediment, is to be 1.4 times its width. The top of the dormer window, including its ridge and pediment, must be lower than the main roof ridge by at least 300mm.
- C15 The pediment of a dormer window must be infilled with timber weatherboards. Depending on the building's architectural style and context, the cheeks of dormer windows may be covered in timber weatherboards or in corrugated steel sheeting of traditional profile. The eaves should be of negligible or minimal depth. Dormer windows, where permitted on street front elevations, are to be traditional timber double-hung sashes or casements.

*Dormers to Federation period cottages, semi-detached dwellings and terraces*

- C16 Dormers to Federation period contributory items should be appropriate to the architectural style. Horizontally proportioned dormers with casement windows are permitted with 'eyelid' or hipped roof forms, the top of which must be located at least 600mm below the main roof ridge line. Horizontally proportioned dormers are limited to 2.2m in width and the window area to a maximum height of 1m, or an overall height of 2.2m dependant on the type.
- C17 Gabled dormers with casement windows may be permitted up to an overall width of 1.5m and a maximum height of 2.2m. The gable form should match the principal roof form and its top must be located at least 300mm below the principal ridgeline. More than one dormer may be permitted if the roof is wider than 6m.

*Modified dormers*

- C18 A dormer window to a contributory item may incorporate doors provided:
- a) it is not visible from the public domain;
  - b) there would be no impact on the heritage significance of the adjacent buildings;
  - c) there would be no adverse impact on the amenity of adjoining properties; and

- d) the traditional dormer form remains visible in a traditional location within the roof, with inward opening casement-styled doors with transoms at the traditional sill height of a dormer window, and a balustrade located in the same plane as the door frame, allowing a person to stand at, but not beyond the door opening.

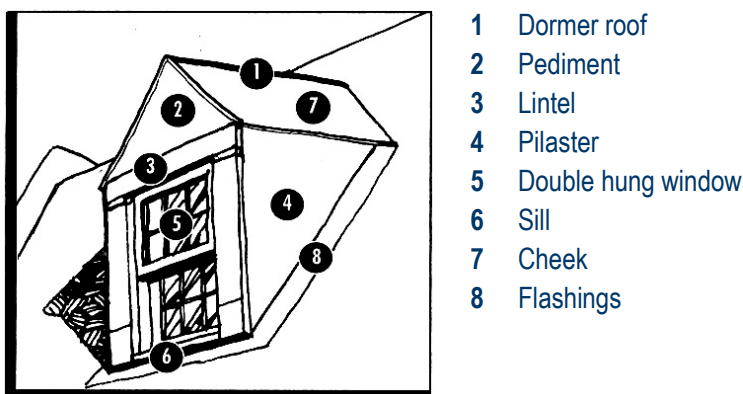
*Contemporary styled dormers*

C19 A contemporary styled dormer may be permitted to the rear roof plane of an individual building where:

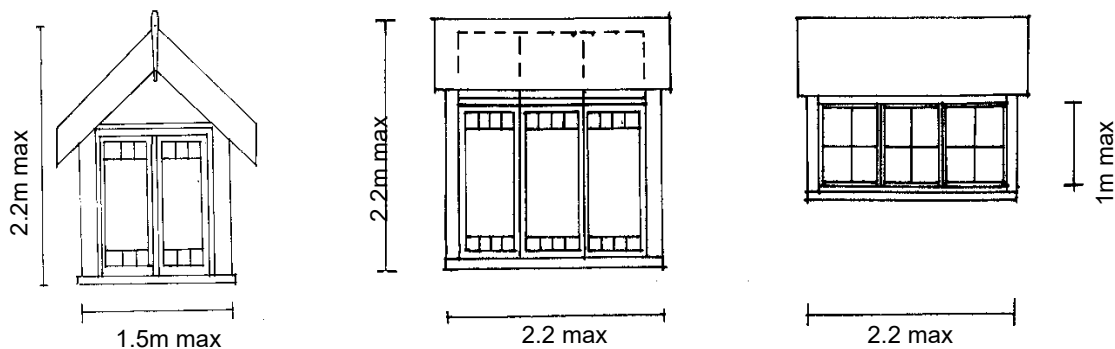
- a) it would not be visible from the public domain;
- b) there would be no impact on the heritage significance of the adjacent buildings; and
- c) traditional forms that relate to the architectural style of the building are preferred.

C20 A Juliette balcony, limited in area by a maximum width of 1.5m and depth of 800mm, may be incorporated with a contemporary styled dormer if there is no adverse impact on the amenity of adjoining properties or on the heritage significance of the adjacent buildings.

**FIGURE 20** Typical Victorian dormer windows



**FIGURE 21** Typical dormers to Federation period cottages, semi-detached dwelling and terraces.



---

### C2.5.6 Open space and landscaping

---

Open space and landscaping play important roles in the preservation of habitat, the establishment of community identity, the provision of recreation opportunities and stormwater management, as well as the amenity of individual dwellings.

Integrated landscape design can enhance the appearance, amenity and energy efficiency of housing.

Landscaping appropriate to building type and period of construction will contribute to the character of the Woollahra HCA.

#### Objectives

- 01 To ensure that adequate provision is made for accessible and useable private open space.
- 02 To retain important existing mature trees, vegetation and other landscape features.
- 03 To ensure the provision of permeable and semi-permeable areas of open space to assist with stormwater management.
- 04 To ensure that swimming pools, spa pools and tennis courts are located where they are not visible from the public domain.
- 05 To ensure that private open space areas, plantings, swimming pools, spa pools and tennis courts are designed to minimise adverse impacts on the heritage significance of the area, services infrastructure, the fabric of buildings and the amenity of neighbours.

#### Controls

##### *Private open space and deep soil landscaped areas*

- C1 Development is to be sited to:
  - a) include sufficient area for deep soil planting;
  - b) have no adverse impact on established tree or vegetation patterns associated with particular building types, streetscapes or precincts; and
  - c) suitably setback from any prescribed tree so that the development does not impact on the health of the tree.

- C2 Deep soil landscaped area requirements for dwelling houses, semi-detached dwellings, attached and detached dual occupancies and attached houses are summarised below:

**TABLE 2** Minimum deep soil landscaped areas by precinct

Precinct	Minimum deep soil landscaped areas required
Rosemont	▶ Lots > 350m <sup>2</sup> = 25% of site area
West Woollahra	▶ Minimum of 15% of site area for lots of 350m <sup>2</sup> - 500m <sup>2</sup> ▶ Minimum of 20% of site area for lots over 500m <sup>2</sup>
Queen Street	▶ Minimum of 15% of site area for lots of 350m <sup>2</sup> - 500m <sup>2</sup> ▶ Minimum of 20% of site area for lots over 500m <sup>2</sup>
Nelson Street	▶ For a significant house on an area of at least 350m <sup>2</sup> – minimum of 25% of the site area ▶ For housing in the Waimea or Woods Avenue groups – minimum of 8% of the site area ▶ For an Inter-War flat building – a minimum of 15% of the site area
Harbour View	▶ Minimum of 12% of site area for lots of 225m <sup>2</sup> - 350m <sup>2</sup> ▶ Minimum of 20% of site area for lots over 350m <sup>2</sup>
Fletcher	▶ Minimum of 15% of site area for lots of 350m <sup>2</sup> - 500m <sup>2</sup> ▶ Minimum of 20% of site area for lots over 500m <sup>2</sup>
Grafton	▶ Minimum of 15% of site area for lots of 350m <sup>2</sup> - 500m <sup>2</sup> ▶ Minimum of 20% of site area for allotments over 500m <sup>2</sup>

- C3 In addition to the above, the following deep soil landscaped area requirements apply to small lots:

**TABLE 3** Minimum deep soil landscaped areas for small lots

Allotment size	Minimum deep soil landscaped area required
Less than 130m <sup>2</sup>	5m <sup>2</sup>
At least 130m <sup>2</sup> and less than 225m <sup>2</sup>	8% of site area
At least 225m <sup>2</sup> and less than 350m <sup>2</sup>	15% of site area*

\* Except for Harbour View Precinct

C4 The minimum private open space area requirements are:

**TABLE 4** Minimum private open space

Residential type	Allotment size	Minimum private open space required
Dwelling houses, semi-detached dwellings, dual occupancies and attached dwellings.	Less 130m <sup>2</sup>	<ul style="list-style-type: none"> <li>► 10% of site area</li> <li>► Principal rear area to have a minimum dimension of 10m<sup>2</sup></li> </ul>
	More than 130m <sup>2</sup> and less than 225m <sup>2</sup>	<ul style="list-style-type: none"> <li>► 16% of site area</li> <li>► Principal rear area to have minimum dimension of 12m<sup>2</sup></li> </ul>
	More than 225m <sup>2</sup>	<ul style="list-style-type: none"> <li>► Minimum of 35m<sup>2</sup></li> <li>► Principal rear area to have minimum dimension of 16m<sup>2</sup></li> </ul>

Note: For the principal rear area, only those areas that can accommodate a 3m diameter circle may be calculated principal rear area.

C5 Residential flat buildings, manor houses, multi dwelling housing and multi dwelling housing (terraces) are to be provided with private open space, unbuilt upon areas and deep soil landscaped areas in accordance with the following table:

**TABLE 5** Minimum private open space and deep soil landscaped area requirements for residential flat buildings, manor houses, multi dwelling housing and multi dwelling housing (terraces)

Residential type	Minimum private open space required	Minimum unbuilt upon area	Minimum deep soil landscaped area required
Residential flat buildings, manor houses, multi dwelling housing and multi dwelling housing (terraces)	N/A	40% of site area	20% of site area
Inter-War flat building	N/A	40% of site area	15% of site area
Each dwelling within a residential flat building in the form of a courtyard, balcony, verandah or roof terrace	<ul style="list-style-type: none"> <li>► Minimum area of 8m<sup>2</sup></li> <li>► Minimum dimension of 2m x 2m</li> </ul>	N/A	N/A

C6 For mixed use buildings, the deep soil landscaped area must comprise at least 10% of the site area.

- 
- C7 In a mixed use development, each dwelling is provided with a private open space area of at least 8m<sup>2</sup> with a minimum dimension of 2m x2m. Private open space for dwellings can be in the form of a courtyard, balcony or verandah.
  - C8 Part of the private open space must be directly accessible from the main living area and capable of serving as an extension of the dwelling for relaxation, dining, entertainment, recreation or children's play.
  - C9 Stairways and ramps may be used to provide access to outdoor living space on sloping sites. The raising of open space areas to provide level access from a building will not be permitted if there would be an adverse impact on adjoining properties or the heritage significance of the property.
  - C10 Materials and colours of paving visible from the public domain are to be appropriate to the character of the streetscape and the architectural style and materials of existing buildings on the site.

#### *Trees and vegetation*

- C11 Mature trees on private land are to be retained in place and incorporated into any proposed landscape treatment.
- C12 Trees and other vegetation are to be of species and size at maturity that will not have an adverse impact on building fabric, significant elements, infrastructure, power lines or other services.
- C13 For infill development, trees are to be selected and located to contribute to energy efficiency and amenity by providing substantial shade in summer, especially to west-facing windows, and by admitting sunlight to indoor and outdoor living areas in winter.
- C14 Where significant trees are to be removed the tree should (subject to site constraints) be replaced with the same species or a species of appropriate size at maturity.
- C15 Landscaping on private land must ensure the retention of adequate sight lines for pedestrians and vehicles, especially at street corners.

#### *Contributory items - landscape elements*

The original garden designs and plant selections of contributory items varied according to their building type and period of construction. The remaining traditional planting schemes, early plants and trees make an important contribution to the character and significance of the HCA.

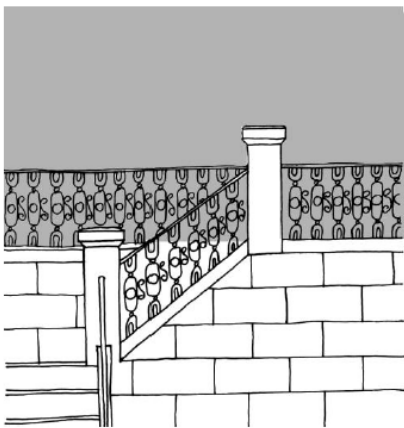
#### **Objectives**

- O6 To retain the significant trees and landscape elements of contributory items.
- O7 To encourage landscaping to be appropriate to building type and period of construction and to contribute to the character of the Woollahra HCA.

### Controls

- C16 Remnant elements of the settings of contributory items including, but not limited to, gardens, mature trees, archaeological deposits, original front fences, pathways and contributory landscape elements are to be retained, whether or not they are located on the same site as the item.
- C17 Trees listed as heritage items and significant cultural plantings (whether identified as contributory items or not) on private land are to be retained in place and incorporated into any proposed landscape treatment.
- C18 Original and early built landscape elements of the yards and gardens of contributory items (including terraces, steps, pathways, front and side fences and outbuildings) are to be retained in place.
- C19 Where new landscaping is proposed to the private open space of contributory items, landscaping styles and plant species must be appropriate to building type and construction period.
- C20 When it is visible from the public domain, landscaping to the private open space of contributory items is to be set at the original garden level or at existing ground level.
- C21 New landscaping must not include species that screen the principal elevation of a contributory item.
- C22 Contributory and characteristic street front gardens are to be retained.

**FIGURE 22** Remnant built landscape elements may be fences from previous buildings



### *Swimming pools and spa pools*

- C23 Swimming pools and spa pools will not be permitted in the front garden or forward of the front building alignment.
- C24 For corner allotments or where the property has two street frontages, the location of swimming pools and spa pools is not to be in the primary frontage.
- C25 Swimming pools and spa pools will not be permitted in the rear of properties if:



- 
- a) construction of the pool would result in the removal of a tree that is subject to a tree preservation order; and
  - b) the deep soil landscaped area requirement cannot be met.
- C26 Where prescribed trees are retained, structures are setbacks so they do not impact on the health of the tree.
- C27 Swimming pools must not cause damage to the fabric of adjoining properties or adversely impact on the amenity of the occupiers of adjoining properties through noise from pool equipment, flood lighting or discharge of backwash.
- C28 The outer edge of the excavation, piling and all sub-surface walls is not less than 1.5m from a boundary.
- C29 Swimming pools are only permitted where the coping will be flush with or not higher than 300mm above the existing ground level and no portion of the pool's casing is visible from the public domain or an adjacent contributory item.
- C30 Structures and associated plant and equipment satisfy the design, construction and operation requirements set out in the Council's standard conditions for:
- a) swimming pools and spa pools, including requirements for drainage of waste water, filtration equipment, fencing, and containment of water from overflow and splashing;
  - b) compliance with the Building Code of Australia;
  - c) identification of levels and heights to Australian Height Datum; and
  - d) structural adequacy.

#### *Tennis courts*

- C31 The location of tennis courts is to be at the rear of properties.
- C32 For corner allotments or where the property has two street frontages, the location of tennis court is not to be in the primary frontage.
- C33 The court playing surface is of a material that minimises light reflection.
- C34 The height and location of court fencing is to enable:
- a) sharing of views from surrounding residences; and
  - b) provision of sunlight to adjoining properties.
- C35 Fencing material is to be a recessive colour.
- C36 Fences are to be setback a minimum of 1.5m from boundaries.
- C37 Safety fencing is provided to satisfy the requirements set out in the Council's standard conditions for swimming pools where the court is designed as a water detention basin with a depth of 300mm or more.

---

### C2.5.7 Fences, gates and retaining walls

---

Carefully designed fences and walls help to integrate developments into the existing streetscape. When poorly designed, however, they have the potential to unduly dominate the streetscape and reduce opportunities for neighbourhood surveillance and social interaction. Tall blank brick fences facing the street are particularly unsympathetic, as they separate the house from the public domain and have an adverse impact on the streetscape, the precinct and the Woollahra HCA as a whole.

#### Objectives

- O1 To ensure the removal, and prevent the construction, of non-original, intrusive tall masonry fences on street alignments.
- O2 To ensure fences, walls and gates contribute positively to the streetscape and improve safety and amenity for residents.

#### Controls

- C1 Fences and gates of non-contributory items and infill development are to be of contemporary design appropriate to the architectural style of the building. Materials should demonstrate an appropriate response to the physical context and historical background of the streetscape and precinct.
- C2 Where street trees occur, new or replacement fences must incorporate root barriers at the street front boundary.
- C3 The height of a front fence is not to exceed 1.5m.
- C4 The height of a side or rear fence is not to exceed 1.8m. Where there is a difference in level from one side of the boundary to the other, the 1.8m limit is measured from the low side. Where there is a difference in ground levels at the boundary greater than 1.2m, the height of the fence must not exceed 1.2m measured from the high side.
- C5 On sloping sites, the height of fences and walls may be averaged. Fences and walls may be regularly stepped down the slope.
- C6 New fences and gates to non-contributory items and infill development are to be at least 50% open to enable outlook from the building to the street.
- C7 New masonry front fences will be permitted only where they were originally associated with the architectural style or building type and construction period of the building on the site.
- C8 On corner sites, new front fences, gates and side fences in front of the building alignment are to be at least 50% open to ensure good visibility for pedestrians and traffic.
- C9 When opening, new gates must not encroach over the footpath and the street carriageway.

---

### ***Contributory items - original fences, gates and retaining walls***

The material and design of the front fences in the Woollahra HCA vary widely according to architectural style, building type and construction period. Original front fences or replacement fences of appropriate materials and design will complement and enhance the character of a building, while inappropriate fences will diminish the appearance of a house and streetscape.

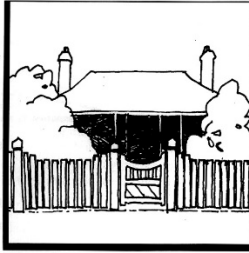
#### **Objectives**

- O3 To retain and conserve original fences, gates and retaining walls of contributory items.
- O4 To retain and conserve original sandstone retaining walls that are characteristic of the precincts within the Woollahra HCA.

#### **Controls**

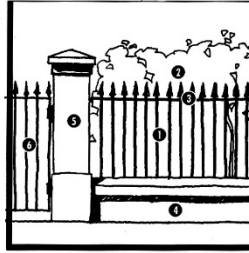
- C10 The configuration, forms, materials, finishes and details of original fences, gates and retaining walls of contributory items are to be retained in place. They are not to be altered except to allow for their maintenance or conservation, even if the building with which they were originally associated has been demolished.
- C11 The configuration, finishes and details of all original sandstone retaining walls that are located at the street front boundaries are to be retained and conserved.
- C12 Breaching an original sandstone or brick wall or fence to incorporate an opening for parking is not permitted.
- C13 Sheet metal fencing, exposed concrete block fencing and aluminium versions of iron palisade fences are not permitted.

**FIGURE 23** Typical original fencing types



**PICKET FENCE**

Early Colonial and Edwardian buildings are associated with timber picket fences. Picket designs varied from Colonial times through to Edwardian times from small rounded tops, to scalloped, spear-ended and flat tops.



**PALISADE FENCE**

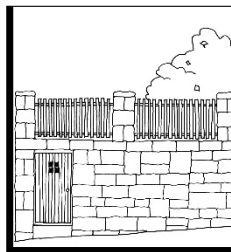
Detailing of iron palisade fences varied from Colonial to early 20th century times.

- 1 Iron palisade bar
- 2 Iron spearhead top
- 3 Top rail
- 4 Coped masonry plinth
- 5 Masonry pier
- 6 Iron gate



**BRICK FENCE**

Inter-War houses and blocks of flats often have brick fences with iron detailing in a style to match the building behind.



**SANDSTONE RETAINING WALL**

Many houses of the federation and Inter-War periods had sandstone front fences or retaining walls.



**BRICK AND TIMBER FENCE**

Brick fenced with painted timber decorative detailing more common during the federation period.

- C14 New front fences, gates and associated elements of contributory items are to be of form, height, details, materials, finishes and quality appropriate to the architectural style, building type and construction period of the existing building on the site and to the precinct.
- C15 New fences and gates to side, rear street or lane alignments of contributory items are to be of a traditional design, height and form and should be consistent with the following table.

**TABLE 6** Dimensions for fences and gates

	Setting	Scale	Massing/form	Materials
<b>Fences</b>	<ul style="list-style-type: none"> <li>▶ Rear fences must be constructed on the rear boundary</li> </ul>	<ul style="list-style-type: none"> <li>▶ Rear fence maximum solid height 1.8m</li> <li>▶ 0.6m high transparent fence may be permitted on top of solid section</li> </ul>		<ul style="list-style-type: none"> <li>▶ Timber palings preferred</li> <li>▶ Bagged or rendered brickwork may be permitted if appropriate to the context.</li> <li>▶ Sheet metal fencing is not permitted</li> </ul>
<b>Laneway gates</b>	<ul style="list-style-type: none"> <li>▶ Conserve original gates, including hardware.</li> <li>▶ Construct gates on rear boundary</li> </ul>	<ul style="list-style-type: none"> <li>▶ Maximum gate height 2.2m</li> <li>▶ Maximum gate width 1.2m</li> <li>▶ Double gates 2.4m</li> <li>▶ Minimum pedestrian gates width 900mm</li> </ul>	<ul style="list-style-type: none"> <li>▶ Minimum 150mm freestanding posts/ reveals or set into fencing</li> </ul>	<ul style="list-style-type: none"> <li>▶ Ledged and braced timber gates</li> <li>▶ Timber painted bi-fold gates</li> <li>▶ Roller shutter only permitted with masonry surrounds</li> <li>▶ Gates are to open within property at all times</li> </ul>
<b>Street gates</b>	<ul style="list-style-type: none"> <li>▶ Gates to align with walls or palisade fences</li> <li>▶ Open parking bays are not permitted within street front locations.</li> </ul>	<ul style="list-style-type: none"> <li>▶ Maximum gate height 2.1m</li> <li>▶ Maximum gate width 1.2m</li> <li>▶ Double gates max. width 2.4m</li> <li>▶ Pedestrian gates 900mm</li> </ul>	<ul style="list-style-type: none"> <li>▶ Gates to open into the property at all times</li> <li>▶ Metal or cast iron posts where appropriate should tie in with adjoining fencing</li> <li>▶ Timber posts where appropriate should tie into the adjoining picket fence</li> </ul>	<ul style="list-style-type: none"> <li>▶ Materials and design of street gates should relate to fence type or context</li> <li>▶ Gates are to open within property at all times</li> </ul>

---

### C2.5.8 Parking and garages

---

Garages built to street alignments intrude inappropriately on streetscapes. The provision of new driveway crossovers often results in the removal of street trees, a reduction in the number of on-street parking spaces and the loss of sections of early stone kerbing.

The inclusion of car parking spaces, carports and garages has resulted in a reduction of landscaped area and useable open space in the front and rear gardens of many properties in the Woollahra HCA. The consequent reduction in the number of trees and the amount of permeable ground surface increases the pressure on surface stormwater drainage systems.

Council’s on-site parking requirements aim to satisfy the parking demand likely to be generated by development while discouraging unnecessary car use. These requirements also aim to reduce site excavation resulting from the provision of excessive amounts of on-site parking. Encouraging walking, cycling and public transport and limiting unnecessary car use helps to improve local amenity, minimise pollution and preserve non-renewable energy resources.

Parking areas, garages and driveways must be designed carefully so that they do not detract from the appearance of the development and the surrounding streetscape.

Additional floor space is occasionally being sought through the provision of a loft structure over a garage or studio. Due to potential streetscape and landscape impacts, a loft structure is not appropriate for garages or studios fronting a street and may be unacceptable for garages or studios on the rear boundaries with access to a laneway. In preparing the loft controls, consideration was given to suitable locations where a loft structure would be appropriate. It was concluded that if the proposals meet particular criteria, loft structures for laneway garages and studios would be acceptable in only three areas in the Woollahra HCA, being Sisters Lane and both the West Woollahra and Grafton Precincts.

#### Objectives

- 01 To protect the amenity of the property, neighbouring properties and public open space in terms of visual and acoustic privacy and sunlight access.
- 02 To ensure that residential buildings, rather than vehicle access and parking structures, remain the dominant elements in the streetscape.
- 03 To ensure that on-site vehicle parking is not provided at the expense of ~~soft~~ landscaped area and useable open space.
- 04 To maintain and enhance the character of laneways where unsympathetic earlier development, such as high brick walls and full width garages, has eroded the quality of these urban spaces.
- 05 To allow safe and convenient vehicle access and to minimise vehicle and pedestrian conflict.
- 06 To only allow loft structures over a garage or studio which is located on the rear boundary of a property within Sisters Lane, or in the West Woollahra or Grafton Precinct.

- 
- 07 To limit the height of garage or studio structures in order to minimise impact on the character of the Woollahra HCA.
  - 08 To ensure loft structures over garages or studios are designed to sympathetically integrate with the character of laneways.
  - 09 To retain and conserve the original coach house and stable structures from the Victorian and Federation periods, and original detached garage buildings of Inter-War houses and flat buildings.

### Controls

- C1 Provision of on-site parking areas, parking structures and servicing areas such as loading facilities will not be a general requirement of Council and may not be permitted in certain circumstances. On-site parking may not be required, or may not be permitted, where it does not comply with controls in this part, or where:
  - a) the parking of a vehicle may have a detrimental impact on the amenity of an adjoining property, the health or form of a significant tree, the character of a streetscape or laneway or the significance or architectural character of a building on the site or on an adjacent site;
  - b) extensive areas of excavation are required;
  - c) a driveway cannot comply with a maximum gradient of 25% with adequate transitions at the top and bottom in accordance with AS 2890.1(2004);
  - d) vehicle entries and exits may have a detrimental impact on pedestrian or traffic movements or Council or service authority infrastructure; and
  - e) inadequate sight distances may result in unsafe vehicle movement to or from the site.
- C2 All parking is to be provided behind the front outer wall of the building.
- C3 No additional vehicle crossovers will be permitted off street frontages.
- C4 No parking is permitted under the principal building form of a dwelling.
- C5 No garages are to be introduced into original retaining walls built to the street alignment.
- C6 In street front situations, even where a crossover exists, double and multiple garages will not be permitted.
- C7 Where crossovers exist on street frontages and there is a minimum side setback of 3m, a car space, carport or garage may be located to the side of a building. This is provided it is set back behind the front alignment of the building or, if freestanding, behind the main ridgeline of the building. The form and materials should complement those of the principal building. An appropriate contemporary design is permitted and must not be an imitation of an historic design.

- 
- C8 If a property has an accessible rear lane, any vehicular access is to be from the rear. Where rear lane parking is permitted and the property is wider than 4.25m, proposals must provide a visual connection between the private and public domain by the inclusion of a pedestrian gate or fencing panel with a minimum width of 900mm and maximum height of 1.8m. Planting along the rear boundary should be incorporated where possible. Garage doors and sections of solid wall should be of minimal width. Garage doors must open into the property.
- C9 On rear lane frontages, elements which create excessive isolation between the public and the private domain, such as high blank walls and excessively wide garage doors, are not acceptable.
- C10 No rear lane vehicle access is permitted to a site if the lot width is less than 3.2m and the distance from the rear of the building (proposed) to the rear boundary is less than 10m.
- C11 If the lane width is less than 5m, rear lane vehicular access is permitted only if there is a minimum garage entry width of 3.2m and it can be demonstrated to Council that turning circles are in compliance with Australian Standard 2890.1 - 2004 (Figure 2.2 and the B85 design template).
- C12 Laneway garages with roof gardens will be permitted only on steeply sloping properties where the floor level of the roof terrace is no higher than the ground floor level of the building and the terrace is non-trafficable except for garden maintenance.
- C13 Garage structures are to be single storey only (for exceptions see control C14)
- C14 A loft structure over a laneway garage or studio will be permitted only in Sisters Lane and in the West Woollahra or Grafton precincts, and then only if:
- a) the structure does not adjoin an existing single storey habitable building on another site where that building is also positioned on a laneway frontage. Note: a garage or carport is not a habitable building;
  - b) the design of the structure protects the amenity of the property, neighbouring properties and public open space in terms of visual and acoustic privacy and sunlight access;
  - c) the site dimensions are a minimum of 30m long and 4.25m wide;
  - d) the maximum width of the loft and single garage or studio is 4.5m;
  - e) the structure does not require the garage footprint to be extended so that the controls in Section 2.5.6 Open Space and Landscaping cannot be satisfied. Where there is an existing non-compliance with these controls, the existing private open space and deep soil landscaped area is not further reduced;
  - f) all access to the loft is provided internally;
  - g) there are no balconies, decks or other similar cantilevered structures;
  - h) habitable room windows within the loft with a direct sightline to those in the existing building on the site and neighbouring buildings have a separation distance of at least 9m;
-



- 
- i) a window or a dormer window in a transverse roof, is a centrally located single double hung sash style or inward opening casement window of traditional proportions;
  - j) there are no dormer windows in a gable-ended roof;
  - k) there are no windows in the gable end of a transverse gable roof;
  - l) skylights, if proposed, are limited to a maximum of two per roof plane, and provided:
    - they comply with C4 in Section 2.5.5 Roofs, skylights and chimneys;
    - each skylight does not exceed an area greater than 1.5m<sup>2</sup>;
    - roof planes do not have more than 25% transparent metal; and
  - m) the proposal complies with the controls for laneway garages with lofts in Table 7.

C15 Loft structures will not be permitted:

- a) over garages or studios in the street front zone;
- b) if the subject property is part of an original row of houses, comprising an unaltered group, and the proposal demonstrates an adverse impact on the group;
- c) if the rear of the property is oriented towards the north between NNE and NNW (true north); and
- d) over a multiple space garage other than a side by side double garage, in which case a transverse gable form is used.

C16 Suitable door types for new garages are, in order of preference, bi-fold panelled doors, panel-lift doors, vertical steel gates and roller shutter doors. Roller shutter doors without a surrounding masonry structure are not permitted.

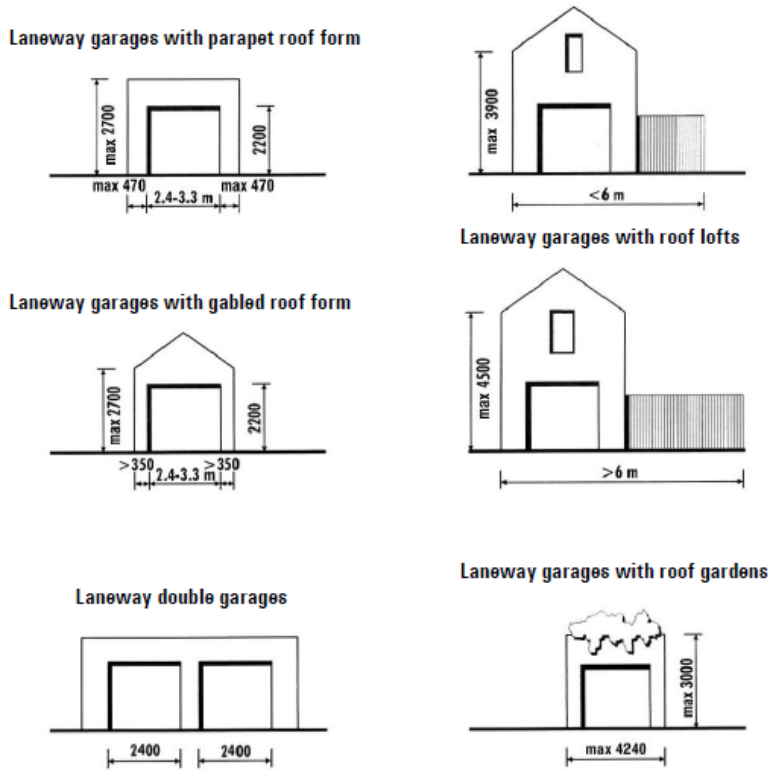
**TABLE 7** Design controls for parking, garages and carports – all dimensions in millimetres

Setting	Scale	Massing/form	Materials
<b>LANEWAY GARAGES - parapet or gable roof form</b>			
<ul style="list-style-type: none"> <li>▶ Preserve original toilets adjacent to laneway boundaries in West Woollahra precinct</li> <li>▶ Build on rear boundary</li> <li>▶ Minimise ramp up to garage</li> <li>▶ Do not dominate existing cottages to residential lanes</li> <li>▶ Provide an acceptable interface between private property and the laneway.</li> </ul>	<ul style="list-style-type: none"> <li>▶ Maximum door height 2200</li> <li>▶ Minimum single door width 2400</li> <li>▶ Maximum single door width 3300 except double garages where each maximum door width is 3000</li> <li>▶ Maximum single garage width 4240</li> <li>▶ Maximum eaves/parapet height 2700</li> </ul>	<ul style="list-style-type: none"> <li>▶ Minimum 350 wide side pillars to gable forms</li> <li>▶ Maximum 470 pillars to flat roof forms or offset gables. A solid to void ratio 1:1 is preferred</li> <li>▶ Flat roof possible if not a corner site</li> <li>▶ Pitched roof preferable to match appropriate traditional roof pitch</li> <li>▶ Single garage doors with maximum 470 pillars between additional doors (max. 2 doors)</li> <li>▶ Double garages are permissible only with a parapet form unless they are permitted by the next subsection: laneway garages with lofts with transverse gables.</li> </ul>	<ul style="list-style-type: none"> <li>▶ Rendered and painted brick</li> <li>▶ Corrugated steel roofing of traditional profile.</li> <li>▶ Timber or metal bi-fold doors, panel-lift doors or roller shutters are permitted</li> <li>▶ Roller shutter permissible only if set within a masonry surround</li> <li>▶ Paint finish to all doors (dark colour recommended)</li> </ul>

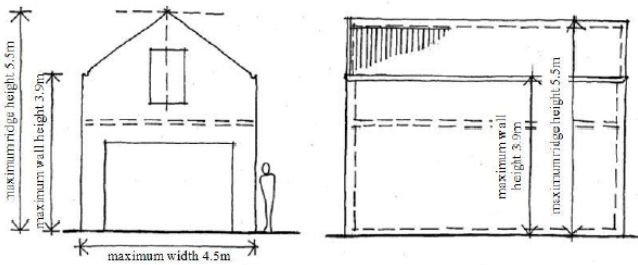
Setting	Scale	Massing/form	Materials
<b>LANEWAY GARAGES WITH LOFTS</b> (only permitted in appropriate situations in West Woollahra and Grafton precincts and Sisters Lane) See C15 and C16			
<ul style="list-style-type: none"> <li>▶ Preserve original stables with lofts</li> <li>▶ Do not dominate existing cottages to residential lanes</li> <li>▶ Build on rear boundary</li> <li>▶ Minimise ramp up to garage</li> <li>▶ Contemporary design based on traditional forms and proportions, rather than the imitation of a historic design, is preferred</li> </ul>	<ul style="list-style-type: none"> <li>▶ Maximum garage door height 2200</li> <li>▶ Minimum garage door width 2400</li> <li>▶ Maximum garage door width 3300</li> <li>▶ Maximum ridge height 5500</li> <li>▶ Maximum eaves height:               <ul style="list-style-type: none"> <li>– for gable ends 3900</li> <li>– for transverse gable roof 2700</li> </ul> </li> </ul>	<ul style="list-style-type: none"> <li>▶ Minimum 470 wide pillars</li> <li>▶ Maximum 600 wide side pillars</li> <li>▶ Single car access only</li> <li>▶ Open second car space is permitted only with gates to lane</li> <li>▶ Gable ended or transverse gable structure only is permitted</li> <li>▶ Pitch and form of roof to match appropriate traditional roof.</li> </ul>	<ul style="list-style-type: none"> <li>▶ Rendered and painted brick or weatherboard cladding</li> <li>▶ Corrugated steel roofing of traditional profile</li> <li>▶ Timber windows and dormers with weatherboard cladding</li> <li>▶ Timber gates or timber panel-lift doors with dark paint finishes</li> <li>▶ Metal roller shutter permissible if set within a masonry surround</li> </ul>
<b>LANEWAY GARAGES WITH ROOF GARDEN</b>			
<ul style="list-style-type: none"> <li>▶ Build on rear boundary</li> <li>▶ Minimise ramp up to garage</li> <li>▶ Allow for 1000 wide (minimum) planting strip with fencing or balustrade (if required) to rear lane and side boundaries</li> </ul>	<ul style="list-style-type: none"> <li>▶ Maximum door height 2200</li> <li>▶ Minimum door width 2000</li> <li>▶ Maximum door width 3300</li> <li>▶ Maximum parapet height 3000</li> <li>▶ Maximum height side fence at rear boundary 3000</li> </ul>	<ul style="list-style-type: none"> <li>▶ Maximum 470 wide side pillars</li> <li>▶ If height exceeds 3000, a transparent material should be used over</li> <li>▶ Hedges and creepers are recommended within planting strip</li> </ul>	<ul style="list-style-type: none"> <li>▶ Rendered and painted brick</li> <li>▶ Concrete slab to roof garden</li> <li>▶ Timber gates or timber panel-lift doors with paint finish</li> <li>▶ Simple timber or metal balustrade over masonry may be parapet required, set back at least 500 from the boundary.</li> </ul>

Setting	Scale	Massing/form	Materials
<b>LANEWAY CARPORT</b>			
<ul style="list-style-type: none"> <li>▶ Build on rear boundary</li> <li>▶ Do not dominate existing cottages to residential lanes</li> <li>▶ Minimise ramp up to garage</li> </ul>	<ul style="list-style-type: none"> <li>▶ Maximum door height 2200</li> <li>▶ Minimum door width 2400</li> <li>▶ Maximum door width 3300</li> <li>▶ Maximum parapet height 2700</li> <li>▶ Maximum height side fence at rear boundary 2700</li> </ul>	<ul style="list-style-type: none"> <li>▶ Maximum 470 wide side pillars</li> <li>▶ Single doors only</li> <li>▶ Flat roof or hipped forms preferred</li> <li>▶ An integral masonry lintel supported on masonry piers with a minimum 350 reveals is required to accommodate door mechanisms.</li> </ul>	<ul style="list-style-type: none"> <li>▶ Timber/metal posts or masonry reveal.</li> <li>▶ Rendered and painted brick</li> <li>▶ Timber gates or timber panel-lift doors with paint finish</li> </ul>
<b>GARAGES WITH STREET ACCESS</b>			
<ul style="list-style-type: none"> <li>▶ Allowed only where cross-overs exist</li> <li>▶ Line of garage should be set back as far as possible from the front wall of the house</li> <li>▶ Minimise ramp up to garage</li> <li>▶ Single garages only to be permitted to streets.</li> </ul>	<ul style="list-style-type: none"> <li>▶ Maximum door height 2200</li> <li>▶ Minimum door width 2400</li> <li>▶ Maximum door width 3300</li> </ul>	<ul style="list-style-type: none"> <li>▶ Maximum 470 wide pillars</li> <li>▶ Gable or parapet form preferred</li> <li>▶ Roof pitch should match appropriate traditional roof pitch</li> </ul>	<ul style="list-style-type: none"> <li>▶ Rendered and painted brick</li> <li>▶ Roof material to be appropriate to the building with which garage is associated.</li> <li>▶ Doors should relate to style of house</li> <li>▶ Timber panel lift is preferred</li> </ul>

**FIGURE 24** Garage maximum dimensions

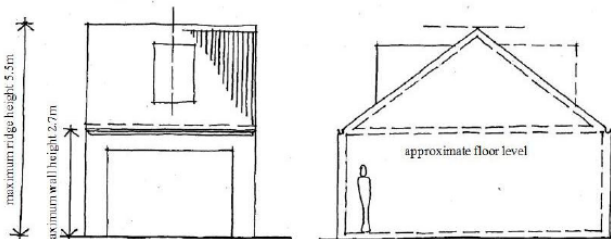


**FIGURE 25** Gable ended loft structure example (including maximum dimensions)



A gable ended roof is defined as: a roof with a gable end facing the street or lane.

**FIGURE 26** Transverse gable loft structure example



A transverse gable roof is defined as: a roof with gable ends, where the ridge is parallel to the rear boundary.

### ***Contributory items - Original garages***

While large houses may have had stables or coach houses, garages and carports and on-site parking areas for motor vehicles were not elements incorporated into Victorian or Federation buildings and their sites. The garage emerged as a building type only with the introduction of the motor vehicle just before World War 1.

#### **Objectives**

- O10 To retain and conserve the original coach house and stable structures from the Victorian and Federation periods.
- O11 To retain and conserve the original detached garage buildings of the Inter-War houses and flat buildings.

#### **Controls**

- C17 Original garages, coach houses, stables and outbuildings must be retained and conserved.
- C18 Original doors to garages that are contemporary with the construction of a contributory item are to be contained and conserved where possible. Where new doors must be added to early garage structures, they are to be appropriate in colour, materials and detail to the original garage building and the contributory item with which it is associated.

---

## C2.5.9 Security

---

Obtrusive security devices, such as external metal grilles and roller shutters, detract from the appearance of individual buildings and the Woollahra HCA as a whole.

### Objectives

- O1 To discourage the addition of window and door grilles and to encourage the use of alternative security measures.
- O2 Where there is no alternative to the installation of window grilles, to ensure that they are designed and painted to be unobtrusive and do not contain decorative pseudo-period detail.

### Controls

- C1 Where additional security is required for buildings, it is to be provided by the least obtrusive method, such as mortice deadlocks, window locks, alarm systems or internal security grilles. External shutters may also be appropriate if shutters were original to the building. External security grilles to windows and doors are discouraged within the Woollahra HCA.
- C2 Where there is no alternative, the installation of external security bars are permitted provided grilles consist of simple unembellished rectangular bars in a vertical pattern or a pattern that reflects the configuration of the glazing bars of the window or door frame. Clear plastic security film may be attached to the internal face of glazing.
- C3 Roller shutters will not be permitted to windows or doors within the Woollahra HCA.

---

## C2.5.10 Excavation

---

Excavation and below ground construction can impact on original footings and walls and natural ground water flows, resulting in potential damage to buildings. The following objectives and controls have been developed to preserve the structural integrity of buildings and to limit groundwater impacts to adjoining and adjacent properties.

### Objectives

- O1 To ensure the structural integrity and stability of individual buildings, the terrace of buildings of which they are a part, and neighbouring properties.
- O2 To protect the original fabric of the buildings significant to the area both during and after excavation.
- O3 To ensure that objectives O1 and O2 are achieved by limiting the circumstances where excavation may occur.
- O4 To limit the impact of excavation on the natural landform and vegetation.
- O5 To relate development to the existing topography and existing ground levels.
- O6 To avoid potential damage to all buildings and structures during and after excavation.
- O7 To ensure that any new floor levels resulting from excavation and development do not compromise external heritage features of the building or those of its neighbours.
- O8 To ensure that habitable rooms created by excavation are supplied with adequate natural light and ventilation in order to meet sustainable building principles.
- O9 To maintain natural subsurface ground water flows.
- O10 To recognise the protection necessary for potential archaeological objects.

### Controls

- C1 Where the existing ground slopes and adjoining properties have basement levels, a basement level may be permitted in development but must not be used as a garage at the street front.
- C2 The building footprint is designed to minimise cut and fill on sloping sites and to encourage good quality internal environments.
- C3 Excavation is not to occur forward of the front façade in the street front zone.
- C4 Sub-surface walls are no closer to the boundary than permitted by the setback controls (refer to Figure 28).



- 
- C5 Notwithstanding C4, for excavation in relation to an existing attached dwelling, semi-detached dwelling, or attached dual occupancy—excavation is not to occur under common walls, footings to common party walls, freestanding boundary walls, or footings to freestanding boundary walls.
- C6 Excavation below 2m and/or within 1.5m of the boundary is accompanied by a geotechnical report and a structural report to demonstrate that the works will not have any adverse effect on the neighbouring structures.

Note: Council may identify other circumstances where these reports are required. All reports must be prepared in accordance with Council's guidelines. Council may also require the preparation and submission of a pre-commencement dilapidation report for properties neighbouring the development.

*Excavation for garage structures*

- C7 Boundary to boundary excavation may be permitted for garage structures on rear laneways if:
- the structure complies with Section 2.5.8 Parking and garages;
  - the structure does not adjoin the principal building form or secondary wing of a building constructed on the common boundary of an adjoining site; and
  - no original footings on adjoining sites will be disturbed.

*Excavation for other structures beyond the principal building form or secondary wing*

- C8 Excavation may be permitted for structures such as pools, spas, or other permissible development if:
- for properties less than 6m in width – the outer edge of excavation is setback from side boundaries by at least 900mm;
  - for properties 6m or more in width – the outer edge of excavation is setback from side boundaries by at least 1.5m;
  - the lowest habitable room, if any, of the proposed development has at least one external wall fully above the existing ground level;
  - no original footings on an adjoining property will be disturbed; and
  - a geotechnical report ensures that works will not have any adverse effect on the neighbouring structures. The report must be prepared in accordance with Council's guidelines.

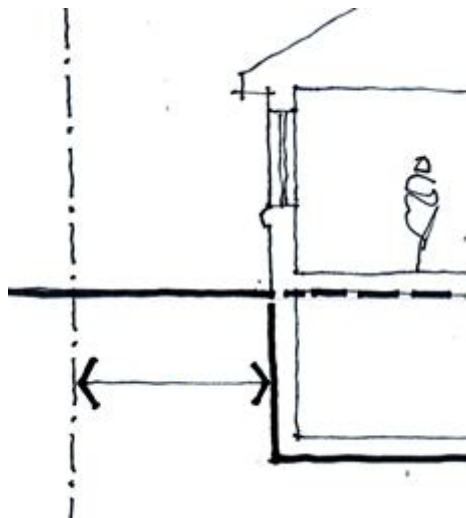


FIGURE 28  
**Sub-surface walls can be no closer to the boundary than the required setback**

---

### C2.5.11 Subdivision and site amalgamation

---

The Woollahra HCA has a complex and varied subdivision pattern which demonstrates the different historical stages of its development and contributes to the area's aesthetically significant visual complexity.

Woollahra LEP 2014 sets the minimum lot size for subdividing land. These DCP controls seek to ensure that future subdivision and site amalgamation responds appropriately to the historical pattern of subdivision.

#### Objectives

- O1 To retain the historically based subdivision patterns of the Woollahra HCA.
- O2 To ensure that subdivisions or site amalgamations will not lead to adverse impacts on the curtilages or settings of contributory items.
- O3 To ensure that subdivision or amalgamation of sites provides an appropriate response to the historical character of the heritage conservation area and the relevant aspects of its historical pattern of development.

#### Controls

- C1 Subdivision of an existing lot to create a new lot, or to amalgamate a number of lots, must be of a size which reflects the characteristics of historically relevant lots adjoining and in the vicinity of the site.
- C2 Where lots are amalgamated, the demolition of contributory items on the original lots will not be permitted.
- C3 Public lanes and public pedestrian passageways are not to be amalgamated with private land.

---

## C2.5.12 Acoustic and visual privacy

---

Levels of acoustic and visual privacy are major determinants of the ability of residents and their neighbours to enjoy living in their homes.

The privacy needs of residents and neighbours should be considered at all stages of design, including the location of new buildings or alterations and additions, the placement of windows and the selection of materials and construction techniques.

Visual privacy can be achieved by layout that prevents overlooking or by incorporating screening and separation.

The required level of acoustic isolation depends upon the location of habitable rooms relative to noise sources such as air conditioning units, swimming pool pumps and major roads. Construction details need to be carefully considered to maximise acoustic privacy both within and between buildings.

### Objectives

- O1 To ensure an adequate degree of acoustic and visual privacy in building design.
- O2 To minimise the impact of new development, which includes alterations and additions to existing buildings, on the acoustic and visual privacy of existing development on neighbouring land.

### Controls

- C1 Bedrooms of one dwelling are not to share walls with living rooms or garages of another dwelling.
- C2 Bedroom windows are to be located at least 3m from streets, shared driveways and parking areas of other dwellings.
- C3 In sensitive locations, such as on busy roads or where commercial, retail or other non-residential buildings are close to residential properties, an acoustic report prepared by a suitably qualified and experienced professional may be required by the Council as part of the site and context analysis process.
- C4 Sound attenuation measures such as acoustic glazing and insulation are to be provided for new development close to high-noise sources such as busy roads and the Eastern Suburbs railway line. The design in these circumstances is to be certified by a qualified Acoustic Engineer.
- C5 Electrical, mechanical, hydraulic and air conditioning equipment is to be housed so that it does not create an 'offensive noise' as defined in the *Protection of the Environment Operations Act 1997*, either within or at the boundaries of any property at any time of the day.
- C6 Windows, balconies, screening devices and landscaping must be located to minimise direct overlooking of the main living areas and private open spaces of neighbouring properties.

- 
- C7 Windows to bathrooms, toilets, laundries and storage rooms must be fitted with obscure glazing if they allow direct views to or from main living areas and private open spaces of neighbouring properties.
- C8 Rear and side balconies must not impact on the privacy of the building's occupants and on the occupants of neighbouring properties. This may require the use of privacy screens, which should be designed with regard to the architectural style of the building.
- C9 Habitable room windows with a direct sightline to another dwelling's habitable room windows within 9m must:
- a) be offset by a distance sufficient to restrict views into the other window; or
  - b) have sill heights of 1.5m above floor level; or
  - c) have fixed obscure glazing in any part of the window less than 1.5m above floor level.
- C10 Direct overlooking of the main living areas or private open space of an existing dwelling from windows, balconies, stairs, landings, terraces and decks or other private, communal or public areas within a development is to be obscured or screened. No screening is required where:
- a) windows are in bathrooms, toilets, laundries, storage rooms or other non-habitable rooms and have obscure glazing or a sill height of 1.5m or more above floor level; or
  - b) windows are in habitable rooms and have a sill height of 1.5m or more above floor level or obscure glazing in any part of the window less than 1.5m above floor level.
- C11 Screens are to be designed with regard to the architectural style of the building.
- C12 Windows and balconies of an upper-level dwelling should be designed to prevent overlooking of the private open space of a lower-level dwelling directly below and within the same development.
- C13 Balconies should be designed to provide privacy for occupants of the building when viewed from the street or nearby public space without the balcony detailing conflicting with period detailing.

---

### C2.5.13 Site facilities and aerial devices

---

The roofs of the Woollahra HCA are integral components of its character and heritage significance. The introduction of unsympathetic and uncharacteristic site facilities such as air-conditioning units and condensers and aerial devices can have an adverse impact on the aesthetic significance of individual buildings and precincts and the area as a whole. Fixing these structures onto roofs and chimneys can also damage the original fabric and detail.

The location and design of other site facilities such as fire safety systems, mail boxes, external storage facilities, clothes drying areas and laundry facilities can also have a detrimental impact on the appearance and character of the area and must be carefully considered.

Note: Solar energy systems such as photovoltaic electricity generating systems, solar hot water systems, or solar air heating systems are addressed in Chapter E6, Section 6.3 Solar Energy Systems.

#### Objectives

- 01 To retain the character of the original roofscape of the Woollahra HCA.
- 02 To protect the original fabric and details of roofs and chimneys.
- 03 To ensure that satellite dishes, aerials and similar devices, air-conditioning units, external condensers and other site facilities do not detrimentally impact on the character and significance of individual buildings and the streetscape.
- 04 To ensure that adequate provision is made for essential site facilities.
- 05 To ensure that the essential site facilities are functional, accessible and are easy to maintain.
- 06 To ensure that site facilities are thoughtfully integrated into development and are unobtrusive.
- 07 To minimise visual and acoustic impacts on adjoining properties.

#### Controls

- C1 Service infrastructure of all infill or replacement development should be located underground.
- C2 Satellite dishes, aerials and similar devices:
  - a) must not be located on any part of the roof or chimney which is visible from the street frontage or the public domain;
  - b) must not have a detrimental impact on the architectural and heritage character of the building to which they are attached; and
  - c) are to be suitably located, designed, sized, enclosed, concealed, screened and/or otherwise integrated with the building to be visually discreet and unobtrusive and to minimise impacts on adjoining properties.

- 
- C3 Air conditioning units, condensers and other mechanical plant equipment in infill development or substantial additions must be located internally within the building.
- C4 Any part of an air conditioning unit, condenser and any other mechanical plant equipment located externally must be located:
- behind the outer front wall of the building and not be visible from the public domain;
  - less than 1.8m above existing ground level or a basement level or part underground level (but not on a roof); and
  - to minimise noise impacts on adjoining properties.
- C5 Air conditioning units, condensers and other mechanical plant equipment must be wholly contained within the permissible building envelope and not be visible from an adjoining property whilst being suitably located, designed, sized, enclosed, concealed, screened and/or otherwise integrated with the building.
- C6 External conduits must not exceed 3m in length and must not be visible from the public domain.
- C7 Hydraulic fire services such as fire hydrants and booster installations must be concealed. These services are to be:
- Enclosed with doors if located in the building façade, or
  - Housed in a cabinet or enclosure if located external to the building.
- The location, design, colour and material of the doors, cabinet or enclosure must be visually unobtrusive and suitably integrated with the development, including fencing and landscaping.
- C8 Television aerials are to be located within the roof area where practicable. If this option is not suitable for reasons such as lack of space or if the area is being used for storage or habitation, the aerial should be located on a secondary rear roof rather than attached to a main chimney.
- C9 Site facilities, including mail boxes, external storage facilities, clothes drying areas and laundry facilities are to be unobtrusively integrated into new development.
- Note: Information relating to specific requirements for garbage and recycling is contained in Part E of this DCP, Chapter E5 Waste Management and Council's DA Guide.
- C10 An electricity substation is to be suitably located, screened and/or concealed so it is not visible from the street, or any other adjoining public place. Council's preference is for a chamber substation. Any screening or enclosure to conceal the substation is to be visually unobtrusive and suitably integrated with the development, including the fencing and landscape design.
- C11 The electricity substation is to be located away from neighbouring properties or sufficiently screened from neighbouring properties.
- C12 The location and design of the electricity substation must be considered and integrated with the landscaping of the proposed development, and must ensure that:
-

- a) Vegetation does not overhang or encroach within the substation site.
- b) The substation is installed outside of the mature growth root zone of any trees to be retained, or proposed to be planted, to prevent roots damage to underground cables.

C13 The design and location of all other aboveground utility infrastructure (such as electrical pillars etc.) should minimise visual clutter within the streetscape and provide for a continuous accessible path of travel, where practical to ensure safe and equitable pedestrian circulation for people of all abilities. (Where this provision and Ausgrid's requirements cannot both be satisfied, the applicant is to develop in consultation with Council and Ausgrid a solution that meets the acceptance of both consent authorities.)

Notes:

- At the DA stage the applicant should demonstrate that they have engaged with Ausgrid and have a network capacity assessment undertaken for the proposed development.
- Where a substation is required, the substation should be identified on the DA plans and addressed in the *SEPP 65 Design Verification Statement* (also see Apartment Design Guide Objective 3C-2 Amenity of the public domain is retained and enhanced).
- The DCP requirements for substations apply in addition to the Ausgrid Network Standards, such as *NS113 Site selection and construction design requirements for chamber substations*. Separate Ausgrid approval for the substation will be required.
- A dedicated access way/easement through the site to the substation will also need to be provided in accordance with the requirements of Ausgrid and Council.



---

## C2.6 Public domain

The public domain describes those areas of land owned and/or managed by Council or other public authorities. The public domain includes roadways, gutters, kerbs, footpaths, street name inlays, retaining walls, landscaped verges and reserves, natural landforms and other elements located beyond private property boundaries.

The public domain plays a significant role in determining the overall character of the Woollahra HCA.

In addition to the following provisions, the general development objectives and controls in Section C2.5 also apply within the public domain.

### Objectives

- 01 To ensure the conservation of existing elements of the public domain that contribute towards the distinctive character of the Woollahra HCA.
- 02 To ensure that new elements are appropriately designed and managed to retain and enhance the character of the area and its precincts.
- 03 To ensure that new elements within the public domain are discreet and unobtrusive in terms of colours, materials and location.

## C2.6.1 Landscape elements

---

### Controls

#### *Steps, ramps, walls and railings*

- C1 Original stone steps and retaining walls should be retained and conserved in place using appropriate conservation methods.
- C2 Materials for new steps should be concrete or sandstone, depending on the historical background and significance of their location.
- C3 Steps and ramps should be assessed for opportunities to incorporate multi-levelled pocket parks with seating, amenities and vistas.
- C4 Railings should be appropriate to nearby contributory items and the streetscape.
- C5 New retaining walls should be designed to be similar in character, height and materials to traditional retaining walls in the area. Appropriate materials may include sandstone and face brick.

---

## C2.6.2 Kerbs and gutters

---

### Controls

#### *Kerbs and gutters*

- C1 All original fly-ash kerbs and gutters should be retained.
- C2 All original sandstone and trachyte kerbs and gutters should be retained where possible. If stone kerbs and gutters are required to be removed they should be stockpiled for re-use in new works.
- C3 Damaged original stone kerbs and gutters should be restored or, where this is not possible, replaced with new stone kerbs and gutters detailed to match existing.
- C4 New crossovers and chicanes will not be permitted as they interrupt the original line of the streets and stone kerbing.
- C5 The kerb alignment should be retained parallel to the building line to preserve the character of streets.
- C6 Where footpaths are widened, original stone or fly-ash kerbs should be left in their original position so that the earlier street form can be understood.
- C7 The profile of all new kerbs should reflect the traditional kerb detail.
- C8 Where concrete kerbs are to be used, precast segmental elements are preferred.
- C9 All street name inlays in kerbs and gutters are to be retained.

#### *Parking areas*

- C10 Public off-street car parking areas should be planted with appropriate species to soften visual impact, provide shade and screen parking from adjacent residential development.

### C2.6.3 Public art

---

#### Controls

- C1 Selection of artworks should favour innovation and diversity.
- C2 Opportunities to showcase art by young designers may appear in places where transient displays are appropriate.
- C3 Public artwork should have resonance and meaning to the community of Woollahra.
- C4 Public art should be low-maintenance and vandal-resistant.

### C2.6.4 Views and vistas

---

#### Controls

- C1 Street tree planting and new development in the public domain should respect existing view corridors. Both should be designed and located to minimise the impact on and, where possible, improve existing vistas.

## C2.7 Schedule of contributory items

Note: Heritage items as identified in Schedule 5 of Woollahra LEP 2014 are also contributory items. Refer to clause 5.10 of the LEP for heritage conservation controls.

Street	Street number	Description	H or C	Group element	Precinct
<b>Adelaide Street</b>	<b>Odd</b>				
Adelaide Street	19	Federation house	C		Grafton
Adelaide Street	21	Federation house	C		Grafton
Adelaide Street	55	Inter-War flat building	C		Fletcher
Adelaide Street	57	Victorian terrace house	C	1 of 5	Fletcher
Adelaide Street	59	Victorian terrace house	C	2 of 5	Fletcher
Adelaide Street	61	Victorian terrace house	C	3 of 5	Fletcher
Adelaide Street	63	Victorian terrace house	C	4 of 5	Fletcher
Adelaide Street	65	Victorian terrace house	C	5 of 5	Fletcher
Adelaide Street	67	Victorian semi-detached house	C	1 of 2	Fletcher
Adelaide Street	69	Victorian semi-detached house	C	2 of 2	Fletcher
Adelaide Street	71	Federation terrace house	C	1 of 7	Fletcher
Adelaide Street	73	Federation terrace house	C	2 of 7	Fletcher
Adelaide Street	75	Federation terrace house	C	3 of 7	Fletcher
Adelaide Street	77	Federation terrace house	C	4 of 7	Fletcher
Adelaide Street	79	Federation terrace house	C	5 of 7	Fletcher
Adelaide Street	81	Federation terrace house	C	6 of 7	Fletcher
Adelaide Street	83	Federation terrace house	C	7 of 7	Fletcher
<b>Adelaide Street</b>	<b>Even</b>				
Adelaide Street	32	Federation semi-detached house	C	1 of 2	Grafton
Adelaide Street	34	Federation semi-detached house	C	2 of 2	Grafton
Adelaide Street	36	Federation terrace house	C	1 of 6	Grafton
Adelaide Street	38	Federation terrace house	C	2 of 6	Grafton
Adelaide Street	40	Federation terrace house	C	3 of 6	Grafton
Adelaide Street	42	Federation terrace house	C	4 of 6	Grafton
Adelaide Street	44	Federation terrace house	C	5 of 6	Grafton
Adelaide Street	46	Federation terrace house	C	6 of 6	Grafton
Adelaide Street	48	Federation semi-detached house	C	1 of 2	Grafton

Street	Street number	Description	H or C	Group element	Precinct
Adelaide Street	50	Federation semi-detached house	C	2 of 2	Grafton
Adelaide Street	52	Federation semi-detached house	C	1 of 2	Grafton
Adelaide Street	54	Federation semi-detached house	C	2 of 2	Grafton
Adelaide Street	58	Federation terrace house	C	1 of 7	Fletcher
Adelaide Street	60	Federation terrace house	C	2 of 7	Fletcher
Adelaide Street	62	Federation terrace house	C	3 of 7	Fletcher
Adelaide Street	64	Federation terrace house	C	4 of 7	Fletcher
Adelaide Street	66	Federation terrace house	C	5 of 7	Fletcher
Adelaide Street	68	Federation terrace house	C	6 of 7	Fletcher
Adelaide Street	70	Federation terrace house	C	7 of 7	Fletcher
Adelaide Street	74	Federation house	C		Fletcher
Adelaide Street	76	Federation house	C		Fletcher
<b>Albert Street</b>	<b>Odd</b>				
Albert Street	1	Victorian semi-detached house	C	1 of 2	Rosemont
Albert Street	3	Victorian semi-detached house	C	2 of 2	Rosemont
Albert Street	5	Victorian semi-detached house	C	1 of 2	Rosemont
Albert Street	7	Victorian semi-detached house	C	2 of 2	Rosemont
Albert Street	9	Victorian semi-detached house	C	1 of 2	Rosemont
Albert Street	11	Victorian semi-detached house	C	2 of 2	Rosemont
Albert Street	13-15	Federation building	C		Rosemont
<b>Albert Street</b>	<b>Even</b>				
Albert Street	20	Inter-War house	C		Rosemont
Albert Street See also 18a	22	Inter-War flat building	C		Rosemont
Albert Street See also 22	18a	Remnant garden terraces and stairs from 'Eynesbury', now demolished. Retaining Wall	C		Rosemont
<b>Alton Street</b>	<b>Odd</b>				
Alton Street	3	Victorian house	C		W Woollahra
Alton Street	19	Victorian house	C		W Woollahra
Alton Street	21	Victorian house	C		W Woollahra
Alton Street	23	Victorian terrace house	C	1 of 3	W Woollahra
Alton Street	25	Victorian terrace house	C	2 of 3	W Woollahra

Street	Street number	Description	H or C	Group element	Precinct
Alton Street	27	Victorian terrace house	C	3 of 3	W Woollahra
<b>Alton Street</b>	<b>Even</b>				
Alton Street	2	Victorian house	C		W Woollahra
Alton Street	6	Victorian semi-detached house	C	1 of 2	W Woollahra
Alton Street	8	Victorian semi-detached house	C	2 of 2	W Woollahra
<b>Bathurst Street</b>	<b>Odd</b>				
Bathurst Street	3	Federation house	C		Harbour View
Bathurst Street	5	Federation house	C		Harbour View
Bathurst Street	7	Federation house	C		Harbour View
Bathurst Street	9	Inter-War flat building	C		Harbour View
Bathurst Street	11	Federation house	C		Harbour View
Bathurst Street	13	Federation house	C		Harbour View
Bathurst Street	15	Federation house	C		Harbour View
Bathurst Street	17	Federation house	C		Harbour View
Bathurst Street	19	Federation house	C		Harbour View
Bathurst Street	21	Federation semi-detached house	C	1 of 2	Harbour View
Bathurst Street	23	Federation semi-detached house	C	2 of 2	Harbour View
Bathurst Street	25	Federation semi-detached house	C	1 of 2	Harbour View
Bathurst Street	27	Federation semi-detached house	C	2 of 2	Harbour View
Bathurst Street	29	Federation house	C		Harbour View
Bathurst Street	31	Federation house	C		Harbour View
Bathurst Street	33	Federation house	C		Harbour View
Bathurst Street	35	Federation house	C		Harbour View
Bathurst Street	37	Federation house	C		Harbour View
Bathurst Street	39	Federation house	C		Harbour View
Bathurst Street	41	Federation house	C		Harbour View
Bathurst Street	45	Federation house	C		Harbour View
<b>Bathurst Street</b>	<b>Even</b>				
Bathurst Street	2	Federation house	C		Harbour View
Bathurst Street	4	Federation house	C		Harbour View
Bathurst Street	6	Federation house	C		Harbour View
Bathurst Street	8	Federation house	C		Harbour View

Street	Street number	Description	H or C	Group element	Precinct
Bathurst Street	16	Federation house	C		Harbour View
Bathurst Street	20	Federation house	C		Harbour View
Bathurst Street	22	Federation semi-detached house	C	1 of 2	Harbour View
Bathurst Street	24	Federation semi-detached house	C	2 of 2	Harbour View
Bathurst Street	26	Federation semi-detached house	C	1 of 2	Harbour View
Bathurst Street	28	Federation semi-detached house	C	2 of 2	Harbour View
Bathurst Street	30	Federation semi-detached house	C	1 of 2	Harbour View
Bathurst Street	32	Federation semi-detached house	C	2 of 2	Harbour View
Bathurst Street	34	Federation semi-detached house	C	1 of 2	Harbour View
Bathurst Street	36	Federation semi-detached house	C	2 of 2	Harbour View
Bathurst Street	38	Federation semi-detached house	C	1 of 2	Harbour View
Bathurst Street	40	Federation semi-detached house	C	2 of 2	Harbour View
Bathurst Street	42	Federation semi-detached house	C	1 of 2	Harbour View
Bathurst Street	44	Federation semi-detached house	C	2 of 2	Harbour View
Bathurst Street	46	Federation house	C		Harbour View
<b>Bowden Street</b>	<b>Odd</b>				
Bowden Street	1	Victorian semi-detached house	C	1 of 2	W Woollahra
Bowden Street	3	Victorian semi-detached house	C	2 of 2	W Woollahra
Bowden Street	5	Victorian terrace house	C	1 of 8	W Woollahra
Bowden Street	7	Victorian terrace house	C	2 of 8	W Woollahra
Bowden Street	9	Victorian terrace house	C	3 of 8	W Woollahra
Bowden Street	11	Victorian terrace house	C	4 of 8	W Woollahra
Bowden Street	13	Victorian terrace house	C	5 of 8	W Woollahra
Bowden Street	15	Victorian terrace house	C	6 of 8	W Woollahra
Bowden Street	17	Victorian terrace house	C	7 of 8	W Woollahra
Bowden Street	19	Victorian terrace house	C	8 of 8	W Woollahra
<b>Bowden Street</b>	<b>Even</b>				
Bowden Street	4	Victorian house	C		W Woollahra
Bowden Street	6	Victorian house	C		W Woollahra
<b>Edgecliff Road</b>	<b>Odd</b>				
Edgecliff Road	11	Victorian semi-detached house	C	1 of 2	Fletcher
Edgecliff Road	13	Victorian semi-detached house	C	2 of 2	Fletcher



Street	Street number	Description	H or C	Group element	Precinct
Edgecliff Road	15	Victorian house	C		Fletcher
Edgecliff Road	17	Inter-War flat building	C		Fletcher
Edgecliff Road	21	Federation terrace house	C	1 of 4	Fletcher
Edgecliff Road	23	Federation terrace house	C	2 of 4	Fletcher
Edgecliff Road	25	Federation terrace house	C	3 of 4	Fletcher
Edgecliff Road	27	Federation terrace house	C	4 of 4	Fletcher
Edgecliff Road	31	Victorian house	C		Fletcher
Edgecliff Road	49	Federation house	C		Fletcher
Edgecliff Road	51	Federation house	C		Fletcher
Edgecliff Road	53	Inter-War house	C		Fletcher
Edgecliff Road	55	Inter-War house	C		Fletcher
Edgecliff Road	63	Victorian house	C		Fletcher
Edgecliff Road	65	Victorian house	C		Fletcher
Edgecliff Road	67	Inter-War flat building	C		Fletcher
Edgecliff Road	69-71	Retaining wall and fence associated with Victorian house, now demolished	C		Fletcher
Edgecliff Road	69	Inter-War house	C		Fletcher
Edgecliff Road	81	Norfolk Island Pine Holy Cross Primary School	H C		Fletcher
Edgecliff Road	97	Inter-War flat building	C		Fletcher
Edgecliff Road	99	Inter-War building	C		Fletcher
Edgecliff Road	101	Inter-War flat building	C		Fletcher
Edgecliff Road	113	Inter-War flat building	C		Fletcher
Edgecliff Road	115	Inter-War flat building	C		Fletcher
Edgecliff Road	117	Federation terrace house	C	1 of 3	Fletcher
Edgecliff Road	119	Federation terrace house	C	2 of 3	Fletcher
Edgecliff Road	121	Federation terrace house	C	3 of 3	Fletcher
Edgecliff Road	125	Federation house	C		Fletcher
Edgecliff Road	127	Federation house	C		Fletcher
Edgecliff Road	129	Federation house	C		Fletcher
Edgecliff Road	131	Victorian house	C		Fletcher
Edgecliff Road	133	Victorian house	C		Fletcher
Edgecliff Road	135	Victorian house	C		Fletcher

Street	Street number	Description	H or C	Group element	Precinct
Edgecliff Road	137	Victorian house	C		Fletcher
Edgecliff Road	139	Victorian house	C		Fletcher
Edgecliff Road	141	Federation building	C		Fletcher
Edgecliff Road	143	Victorian house	C		Fletcher
Edgecliff Road	145	Federation commercial building	C		Fletcher
Edgecliff Road	147	Victorian house	C		Fletcher
Edgecliff Road	149	Inter-War commercial building	C		Fletcher
Edgecliff Road	151	Inter-War flat building	C		Fletcher
Edgecliff Road	153	Inter-War commercial building	C		Fletcher
Edgecliff Road	155	Inter-War commercial building	C		Fletcher
Edgecliff Road	157	Victorian terrace house	C	1 of 3	Fletcher
Edgecliff Road	159	Victorian terrace house	C	2 of 3	Fletcher
Edgecliff Road	161	Victorian terrace house	C	3 of 3	Fletcher
Edgecliff Road	163	Inter-War commercial building	C		Fletcher
Edgecliff Road	165	Victorian house	C		Fletcher
Edgecliff Road	167	Victorian house	C		Fletcher
Edgecliff Road	169-173	Inter-War flat building	C		Fletcher
Edgecliff Road	177	Victorian terrace house	C	1 of 3	Fletcher
Edgecliff Road	179	Victorian terrace house	C	2 of 3	Fletcher
Edgecliff Road	181	Victorian terrace house	C	3 of 3	Fletcher
Edgecliff Road	181a	Inter-War commercial building	C		Harbour View
Edgecliff Road	183	Federation terrace house	C	1 of 5	Harbour View
Edgecliff Road	185	Federation terrace house	C	2 of 5	Harbour View
Edgecliff Road	187	Federation terrace house	C	3 of 5	Harbour View
Edgecliff Road	189	Federation terrace house	C	4 of 5	Harbour View
Edgecliff Road	191	Federation terrace house	C	5 of 5	Harbour View
Edgecliff Road	193	Federation house	C		Harbour View
Edgecliff Road	195	Federation house	C		Harbour View
Edgecliff Road	201	Victorian semi-detached house	C	1 of 2	Grafton
Edgecliff Road	203	Victorian semi-detached house	C	2 of 2	Grafton
Edgecliff Road	205	Victorian house	C		Grafton
Edgecliff Road	211	Inter-War flat building	C		Grafton

Street	Street number	Description	H or C	Group element	Precinct
Edgecliff Road	217	Victorian house	C		Grafton
Edgecliff Road	225	Federation house	C		Grafton
Edgecliff Road	233	Inter-War flat building	C		Grafton
Edgecliff Road	239	Victorian semi-detached house	C	1 of 2	Grafton
Edgecliff Road	241	Victorian semi-detached house	C	2 of 2	Grafton
Edgecliff Road	247	Victorian house	C		Grafton
Edgecliff Road	251	Victorian house	C		
Edgecliff Road	263	Inter-War house	C		Grafton
Edgecliff Road	267	Federation semi-detached house	C	1 of 2	
Edgecliff Road	269	Federation semi-detached house	C	2 of 2	Grafton
Edgecliff Road	273	Inter-War house	C		Grafton
Edgecliff Road	285	Victorian semi-detached house	C	1 of 2	Rosemont
Edgecliff Road	287	Victorian semi-detached house	C	2 of 2	Rosemont
Edgecliff Road	289	Victorian semi-detached house	C	1 of 2	Rosemont
Edgecliff Road	291	Victorian semi-detached house	C	2 of 2	Rosemont
Edgecliff Road	295a	Inter-War flat building	C		Rosemont
Edgecliff Road	295b	Inter-War house	C		Rosemont
Edgecliff Road	299	Victorian house	C		Rosemont
Edgecliff Road	301	Federation house	C		Rosemont
Edgecliff Road	303	Victorian house	C		Rosemont
Edgecliff Road	305	Inter-War house	C		Rosemont
Edgecliff Road	307-309	Eastern Suburbs railway reserve	C		Rosemont
Edgecliff Road	311	Victorian house	C		Rosemont
Edgecliff Road	311a	Inter-War flat building	C		Rosemont
Edgecliff Road	323	Wallaroy House	C		Rosemont
Edgecliff Road	327	Inter-War house	C		Rosemont
Edgecliff Road	327a	Inter-War house	C		Rosemont
Edgecliff Road	327b	Inter-War house	C		Rosemont
Edgecliff Road	327c	Inter-War house	C		Rosemont
Edgecliff Road	327d	Inter-War house	C		Rosemont
Edgecliff Road	329	Inter-War house	C		Rosemont
Edgecliff Road	331	Inter-War house	C		Rosemont

Street	Street number	Description	H or C	Group element	Precinct
Edgecliff Road	333	Inter-War flat building	C		Rosemont
Edgecliff Road	335	Inter-War flat building	C		Rosemont
Edgecliff Road	337	Inter-War house	C		Rosemont
Edgecliff Road	337b	Inter-War house	C		Rosemont
Edgecliff Road	343	Inter-War flat building	C		Rosemont
Edgecliff Road	343b	Inter-War houses	C		Rosemont
Edgecliff Road	343c	Inter-War houses	C		Rosemont
<b>Edgecliff Road</b>	<b>Even</b>				
Edgecliff Road	8	Victorian house	C		Grafton
Edgecliff Road	10	Victorian house	C		Grafton
Edgecliff Road	12	Federation house	C		Grafton
Edgecliff Road	14	Victorian terrace house	C	1 of 10	Grafton
Edgecliff Road	16	Victorian terrace house	C	2 of 10	Grafton
Edgecliff Road	18	Victorian terrace house	C	3 of 10	Grafton
Edgecliff Road	20	Victorian terrace house	C	4 of 10	Grafton
Edgecliff Road	22	Victorian terrace house	C	5 of 10	Grafton
Edgecliff Road	24	Victorian terrace house	C	6 of 10	Grafton
Edgecliff Road	26	Victorian terrace house	C	7 of 10	Grafton
Edgecliff Road	28	Victorian terrace house	C	8 of 10	Grafton
Edgecliff Road	30	Victorian terrace house	C	9 of 10	Grafton
Edgecliff Road	32	Victorian terrace house	C	10 of 10	Grafton
Edgecliff Road	34	Federation house	C		Grafton
Edgecliff Road	36	Federation semi-detached house	C	1 of 2	Grafton
Edgecliff Road	38	Federation semi-detached house	C	2 of 2	Grafton
Edgecliff Road	40	Federation semi-detached house	C	1 of 2	Grafton
Edgecliff Road	42	Federation semi-detached house	C	2 of 2	Grafton
Edgecliff Road	44	Federation house	C		Grafton
Edgecliff Road	46	Victorian terrace house	C	1 of 4	Grafton
Edgecliff Road	48	Victorian terrace house	C	2 of 4	Grafton
Edgecliff Road	50	Victorian terrace house	C	3 of 4	Grafton
Edgecliff Road	52	Victorian terrace house	C	4 of 4	Grafton
Edgecliff Road	54	Federation semi-detached house	C	1 of 2	Grafton

Street	Street number	Description	H or C	Group element	Precinct
Edgecliff Road	56	Federation semi-detached house	C	2 of 2	Grafton
Edgecliff Road	58	Federation semi-detached house	C	1 of 2	Grafton
Edgecliff Road	60	Federation semi-detached house	C	2 of 2	Grafton
Edgecliff Road	62	Federation semi-detached house	C	1 of 2	Grafton
Edgecliff Road	64	Federation semi-detached house	C	2 of 2	Grafton
Edgecliff Road	82-84	Federation house	C		Grafton
Edgecliff Road	86	Federation house	C		Grafton
Edgecliff Road	88	Federation house	C		Grafton
Edgecliff Road	90	Federation house	C		Grafton
Edgecliff Road	92	Federation house	C		Grafton
Edgecliff Road	94	Federation house	C		Grafton
Edgecliff Road	96	Inter-War flat building	C		Grafton
Edgecliff Road	104	Federation house	C		Grafton
Edgecliff Road	106	Federation house	C		Grafton
Edgecliff Road	108	Victorian terrace house	C	1 of 4	Grafton
Edgecliff Road	110	Victorian terrace house	C	2 of 4	Grafton
Edgecliff Road	112	Victorian terrace house	C	3 of 4	Grafton
Edgecliff Road	114	Victorian terrace house	C	4 of 4	Grafton
Edgecliff Road	116	Victorian house	C		Grafton
Edgecliff Road	118	Victorian house	C		Grafton
Edgecliff Road	120	Victorian corner shop	C		Grafton
Edgecliff Road	126	Inter-War flat building	C		Grafton
Edgecliff Road	128	Victorian terrace house	C	1 of 3	Grafton
Edgecliff Road	130	Victorian terrace house	C	2 of 3	Grafton
Edgecliff Road	132	Victorian terrace house	C	3 of 3	Grafton
Edgecliff Road	134	Mayfair, Inter-War commercial building	C		Grafton
Edgecliff Road	144-148	Inter-War commercial building	C		Grafton
Edgecliff Road	168	Victorian semi-detached house	C	1 of 2	Grafton
Edgecliff Road	170	Victorian semi-detached house	C	2 of 2	Grafton
Edgecliff Road	172	Victorian house	C		Grafton
Edgecliff Road	174	Victorian house	C		Grafton

Street	Street number	Description	H or C	Group element	Precinct
Edgecliff Road	176	Federation terrace house	C	1 of 7	Grafton
Edgecliff Road	178	Federation terrace house	C	2 of 7	Grafton
Edgecliff Road	180	Federation terrace house	C	3 of 7	Grafton
Edgecliff Road	182	Federation terrace house	C	4 of 7	Grafton
Edgecliff Road	184	Federation terrace house	C	5 of 7	Grafton
Edgecliff Road	186	Federation terrace house	C	6 of 7	Grafton
Edgecliff Road	188	Federation terrace house	C	7 of 7	Grafton
Edgecliff Road	194	Victorian terrace house	C	1 of 4	Grafton
Edgecliff Road	196	Victorian terrace house	C	2 of 4	Grafton
Edgecliff Road	198	Victorian terrace house	C	3 of 4	Grafton
Edgecliff Road	200	Victorian terrace house	C	4 of 4	Grafton
Edgecliff Road	202	Victorian house	C		Grafton
Edgecliff Road	204	Victorian house	C		Grafton
Edgecliff Road	222	Victorian semi-detached house	C	1 of 2	Grafton
Edgecliff Road	224	Victorian semi-detached house	C	2 of 2	Grafton
Edgecliff Road	226	Victorian semi-detached house	C	1 of 2	Grafton
Edgecliff Road	228	Victorian semi-detached house	C	2 of 2	Grafton
Edgecliff Road	230	Federation semi-detached house	C	1 of 2	Grafton
Edgecliff Road	232	Federation semi-detached house	C	2 of 2	Grafton
Edgecliff Road	234	Federation semi-detached house	C	1 of 2	Grafton
Edgecliff Road	236	Federation semi-detached house	C	2 of 2	Grafton
Edgecliff Road	238	Federation semi-detached house	C	1 of 2	Grafton
Edgecliff Road	240	Federation semi-detached house	C	2 of 2	Grafton
Edgecliff Road	242	Federation semi-detached house	C	1 of 2	Grafton
Edgecliff Road	244	Federation semi-detached house	C	2 of 2	Grafton
Edgecliff Road	246	Federation house	C		Grafton
Edgecliff Road	248	Federation terrace house	C	1 of 4	Grafton
Edgecliff Road	250	Federation terrace house	C	2 of 4	Grafton
Edgecliff Road	252	Federation terrace house	C	3 of 4	Grafton
Edgecliff Road	254	Federation terrace house	C	4 of 4	Grafton

Street	Street number	Description	H or C	Group element	Precinct
Edgecliff Road	256	Federation terrace house	C	1 of 5	Grafton
Edgecliff Road	258	Federation terrace house	C	2 of 5	Grafton
Edgecliff Road	260	Federation terrace house	C	3 of 5	Grafton
Edgecliff Road	262	Federation terrace house	C	4 of 5	Grafton
Edgecliff Road	264	Federation terrace house	C	5 of 5	Grafton
Edgecliff Road	270	Victorian terrace house	C	1 of 8	Grafton
Edgecliff Road	272	Victorian terrace house	C	2 of 8	Grafton
Edgecliff Road	274	Victorian terrace house	C	3 of 8	Grafton
Edgecliff Road	276	Victorian terrace house	C	4 of 8	Grafton
Edgecliff Road	278	Victorian terrace house	C	5 of 8	Grafton
Edgecliff Road	280	Victorian terrace house	C	6 of 8	Grafton
Edgecliff Road	282	Victorian terrace house	C	7 of 8	Grafton
Edgecliff Road	284	Victorian terrace house	C	8 of 8	Grafton
Edgecliff Road	292	Federation house	C		Grafton
Edgecliff Road	296	Victorian semi-detached house	C	1 of 2	Grafton
Edgecliff Road	298	Victorian semi-detached house	C	2 of 2	Grafton
Edgecliff Road	300	Victorian house	C		Grafton
Edgecliff Road	302	Federation house	C		Grafton
Edgecliff Road	304	Federation house	C		Grafton
Edgecliff Road	308	Victorian house	C		Grafton
Edgecliff Road	314	Federation house	C	1 of 2	Nelson
Edgecliff Road	316	Federation house	C	2 of 2	Nelson
Edgecliff Road	318	Inter-War flat building	C		Nelson
Edgecliff Road	320	Inter-War flat building	C		Nelson
Edgecliff Road	322	Victorian house	C		Nelson
Edgecliff Road	324	Inter-War flat building	C		Nelson
Edgecliff Road	326	Inter-War flat building	C		Nelson
Edgecliff Road	328	Inter-War flat building	C		Nelson
Edgecliff Road	330	Inter-War flat building	C		Nelson
Edgecliff Road	332	Inter-War house	C		Nelson
Edgecliff Road	334	Gaden reserve and community centre	C		Nelson
Edgecliff Road	340	Inter-War flat building	C		Nelson

Street	Street number	Description	H or C	Group element	Precinct
Edgecliff Road	342	Inter-War flat building	C		Nelson
Edgecliff Road	344	Inter-War flat building	C		Nelson
Edgecliff Road	354	Federation residential flat building	C		Rosemont
Edgecliff Road	356	Interwar house	C		Rosemont
Edgecliff Road	364	Federation house	C		Rosemont
Edgecliff Road	380	Inter-War house	C		Rosemont
Edgecliff Road	382	Late 20th century house	C		Rosemont
Edgecliff Road	390	Federation semi-detached house	C	1 of 2	Rosemont
Edgecliff Road	392	Federation semi-detached house	C	2 of 2	Rosemont
Edgecliff Road	394	Federation semi-detached house	C	1 of 2	Rosemont
Edgecliff Road	396	Federation semi-detached house	C	2 of 2	Rosemont
Edgecliff Road	398	Federation house	C		Rosemont
Edgecliff Road	400	Inter-War house	C		Rosemont
Edgecliff Road	402	Inter-War house	C		Rosemont
Edgecliff Road	404	Inter-War house	C		Rosemont
Edgecliff Road	406	Inter-War house			Rosemont
Edgecliff Road	408	Garden to 17 Rosemont Avenue			Rosemont
Edgecliff Road	416-418	Inter-War house	C		Rosemont
Edgecliff Road	420	Inter-War flat building	C		Rosemont
Edgecliff Road	422	Inter-War flat building	C		Rosemont
Edgecliff Road	428	Inter-War house	C		Rosemont
Edgecliff Road	430	Inter-War house	C		Rosemont
Edgecliff Road	432	Inter-War house	C		Rosemont
<b>Edward Street</b>	<b>Odd</b>				
Edward Street	1	Federation house	C		Harbour View
Edward Street	3	Federation house	C		Harbour View
Edward Street	5	Federation house	C		Harbour View
Edward Street	7	Federation semi-detached house	C	1 of 2	Harbour View
Edward Street	9	Federation semi-detached house	C	2 of 2	Harbour View
Edward Street	11	Federation semi-detached house	C	1 of 2	Harbour View
Edward Street	13	Federation semi-detached house	C	2 of 2	Harbour View



Street	Street number	Description	H or C	Group element	Precinct
Edward Street	15	Federation semi-detached house	C	1 of 2	Harbour View
Edward Street	17	Federation semi-detached house	C	2 of 2	Harbour View
Edward Street	19	Federation semi-detached house	C	1 of 2	Harbour View
Edward Street	21	Federation semi-detached house	C	2 of 2	Harbour View
Edward Street	23	Federation house	C		Harbour View
Edward Street	25	Federation house	C		Fletcher
Edward Street	27	Federation house	C		Fletcher
Edward Street	31	Inter-War house	C		Fletcher
Edward Street	37-43	Rockshelf and sandstone walls	C		Fletcher
<b>Edward Street</b>	<b>Even</b>				
Edward Street	2	Federation house	C		Harbour View
Edward Street	4	Federation house	C		Harbour View
Edward Street	6	Federation house	C		Harbour View
Edward Street	8	Federation house	C		Harbour View
Edward Street	10	Federation house	C		Harbour View
Edward Street	12	Federation house	C		Harbour View
Edward Street	14	Federation house	C		Harbour View
Edward Street	16	Federation house	C		Harbour View
Edward Street	18	Federation house	C		Harbour View
Edward Street	20	Federation house	C		Harbour View
Edward Street	22	Federation house	C		Harbour View
Edward Street	24	Federation house	C		Harbour View
Edward Street	26	Federation house	C		Harbour View
Edward Street	28	Federation house	C		Harbour View
Edward Street	30	Federation house	C		Harbour View
Edward Street	32	Federation house	C		Harbour View
Edward Street	34	Federation house	C		Harbour View
Edward Street	36	Federation house	C		Harbour View
Edward Street	38	Federation house	C		Harbour View
Edward Street	40	Federation house	C		Harbour View
Edward Street	42	Federation house	C		Harbour View

Street	Street number	Description	H or C	Group element	Precinct
<b>Fern Place</b>	<i>All</i>				
Fern Place	1	Federation house	C		Grafton
Fern Place	2	Federation house	C		Grafton
Fern Place	3	Federation house	C		Grafton
Fern Place	5	Victorian terrace house	C	1 of 4	Grafton
Fern Place	6	Victorian terrace house	C	2 of 4	Grafton
Fern Place	7	Victorian terrace house	C	3 of 4	Grafton
Fern Place	8	Victorian terrace house	C	4 of 4	Grafton
Fern Place	9	Victorian house	C		Grafton
<b>Fletcher Street</b>	<i>Odd</i>				
Fletcher Street	1	Victorian house	C		Fletcher
Fletcher Street	5	Victorian house	C		Fletcher
Fletcher Street	29	Victorian house	C		Fletcher
Fletcher Street	31	Victorian semi-detached house	C	1 of 2	Fletcher
Fletcher Street	33	Victorian semi-detached house	C	2 of 2	Fletcher
Fletcher Street	35	Victorian semi-detached house	C	1 of 2	Fletcher
Fletcher Street	37	Victorian semi-detached house	C	2 of 2	Fletcher
Fletcher Street	39	Victorian semi-detached house	C	1 of 2	Fletcher
Fletcher Street	41	Victorian semi-detached house	C	2 of 2	Fletcher
Fletcher Street	43	Victorian semi-detached house	C	1 of 2	Fletcher
Fletcher Street	45	Victorian semi-detached house	C	2 of 2	Fletcher
Fletcher Street	47	Victorian semi-detached house	C	1 of 2	Fletcher
Fletcher Street	49	Victorian semi-detached house	C	2 of 2	Fletcher
Fletcher Street	51	Victorian shop	C		Fletcher
<b>Fletcher Street</b>	<i>Even</i>				
Fletcher Street	16	Victorian house	C		Fletcher
Fletcher Street	18	Victorian house	C		Fletcher
Fletcher Street	20	Victorian house	C		Fletcher
Fletcher Street	22	Victorian house	C		Fletcher
Fletcher Street	30	Inter-War house	C		Fletcher
Fletcher Street	40-44	Late 20th century religious building	C		Fletcher

Street	Street number	Description	H or C	Group element	Precinct
Fletcher Street	54	Victorian house	C	1 of 2	Fletcher
Fletcher Street	56	Victorian house	C	2 of 2	Fletcher
Fletcher Street	58	Victorian semi-detached house	C	1 of 2	Fletcher
Fletcher Street	60	Victorian semi-detached house	C	2 of 2	Fletcher
Fletcher Street	66	Victorian house	C		Fletcher
Fletcher Street	92	Victorian corner shop	C		Fletcher
Fletcher Street	94	Victorian house	C		Fletcher
Fletcher Street	96	Victorian house	C		Fletcher
Fletcher Street	100	Federation terrace house	C	1 of 4	Fletcher
Fletcher Street	102	Federation terrace house	C	2 of 4	Fletcher
Fletcher Street	104	Federation terrace house	C	3 of 4	Fletcher
Fletcher Street	106	Federation terrace house	C	4 of 4	Fletcher
Fletcher Street	112	Victorian terrace house	C	1 of 5	Fletcher
Fletcher Street	114	Victorian terrace house	C	2 of 5	Fletcher
Fletcher Street	116	Victorian terrace house	C	3 of 5	Fletcher
Fletcher Street	118	Victorian terrace house	C	4 of 5	Fletcher
Fletcher Street	120	Victorian terrace house	C	5 of 5	Fletcher
Fletcher Street	122	Victorian house	C		Fletcher
Fletcher Street	124	Victorian house	C		Fletcher
Fletcher Street	132	Victorian house	C		Fletcher
Fletcher Street	134	Victorian semi-detached house	C	1 of 2	Fletcher
Fletcher Street	136	Victorian semi-detached house	C	2 of 2	Fletcher
Fletcher Street	140-142	Inter-War house	C		Fletcher
Fletcher Street	144	Victorian house	C		Fletcher
Fletcher Street	148	Federation semi-detached house	C	1 of 2	Fletcher
Fletcher Street	150	Federation semi-detached house	C	2 of 2	Fletcher
Fletcher Street	152	Victorian house	C		Fletcher
Fletcher Street	154	Victorian house	C		Fletcher
Fletcher Street	156	Federation semi-detached house	C	1 of 2	Fletcher
Fletcher Street	158	Federation semi-detached house	C	2 of 2	Fletcher
Fletcher Street	160	Federation semi-detached house	C	1 of 2	Fletcher
Fletcher Street	162	Federation semi-detached house	C	2 of 2	Fletcher

Street	Street number	Description	H or C	Group element	Precinct
<b>Forth Street</b>	<b>Odd</b>				
Forth Street	1	Victorian house	C		W Woollahra
Forth Street	1a	Victorian house	C		W Woollahra
Forth Street	3	Victorian house	C		W Woollahra
Forth Street	5a	Victorian house	C		W Woollahra
Forth Street	15	Victorian house	C		W Woollahra
Forth Street	17	Victorian house	C		W Woollahra
Forth Street	21	Victorian house	C		W Woollahra
Forth Street	23	Victorian house	C		W Woollahra
Forth Street	27	Victorian house	C		W Woollahra
Forth Street	29	Victorian semi-detached house	C	1 of 2	W Woollahra
Forth Street	31	Victorian semi-detached house	C	2 of 2	W Woollahra
Forth Street	33	Victorian house	C		W Woollahra
Forth Street	35	Victorian house	C		W Woollahra
Forth Street	37	Victorian house	C		W Woollahra
Forth Street	41	Federation house	C		W Woollahra
<b>Fullerton Street</b>	<b>Odd</b>				
Fullerton Street	5	Inter-War house	C		Rosemont
Fullerton Street	11a	Wolper hospital, former Federation house	C		Rosemont
Fullerton Street	13-17	Element - Retaining Wall or Fence - Remnant of fence from 'Quiraing', now demolished	C		Rosemont
<b>Fullerton Street</b>	<b>Even</b>				
Fullerton Street	2	Inter-War flat building	C		Rosemont
Fullerton Street	4	Inter-War flat building	C		Rosemont
Fullerton Street	6	Inter-War flat building	C		Rosemont
Fullerton Street	18	Federation house	C		Rosemont
<b>Grosvenor Street</b>	<b>Odd</b>				
Grosvenor Street	27	Victorian house	C		Grafton
Grosvenor Street	29	Victorian house	C		Grafton
Grosvenor Street	31	Victorian house	C		Grafton
Grosvenor Street	33	Victorian house	C		Grafton

Street	Street number	Description	H or C	Group element	Precinct
Grosvenor Street	35	Victorian house	C		Grafton
Grosvenor Street	37	Victorian house	C		Grafton
Grosvenor Street	39	Victorian house	C		Grafton
Grosvenor Street	41	Victorian house	C		Grafton
Grosvenor Street	43	Victorian house	C		Grafton
Grosvenor Street	45	Victorian house	C		Grafton
Grosvenor Street	47	Victorian house	C		Grafton
Grosvenor Street	49	Victorian house	C		Grafton
Grosvenor Street	51	Victorian house	C		Grafton
Grosvenor Street	53	Victorian semi-detached house	C	1 of 2	Grafton
Grosvenor Street	55	Victorian semi-detached house	C	2 of 2	Grafton
<b>Grosvenor Street</b>	<b><i>Even</i></b>				
Grosvenor Street	40	Victorian house	C		Grafton
Grosvenor Street	42	Victorian house	C		Grafton
Grosvenor Street	44	Victorian house	C		Grafton
Grosvenor Street	46	Victorian house	C		Grafton
Grosvenor Street	48	Victorian terrace house	C	1 of 4	Grafton
Grosvenor Street	50	Victorian terrace house	C	2 of 4	Grafton
Grosvenor Street	52	Victorian terrace house	C	3 of 4	Grafton
Grosvenor Street	54	Victorian terrace house	C	4 of 4	Grafton
Grosvenor Street	56	Victorian house	C		Grafton
Grosvenor Street	58	Victorian house	C		Grafton
Grosvenor Street	62	Victorian house	C		Grafton
Grosvenor Street	64	Victorian house	C		Grafton
<b>Harkness Street</b>	<b><i>Odd</i></b>				
Harkness Street	1	Federation terrace house	C	1 of 6	Harbour View
Harkness Street	3	Federation terrace house	C	2 of 6	Harbour View
Harkness Street	5	Federation terrace house	C	3 of 6	Harbour View
Harkness Street	7	Federation terrace house	C	4 of 6	Harbour View
Harkness Street	9	Federation terrace house	C	5 of 6	Harbour View
Harkness Street	11	Federation terrace house	C	6 of 6	Harbour View
Harkness Street	13	Inter-War house	C		Harbour View

Street	Street number	Description	H or C	Group element	Precinct
Harkness Street	15	Federation House	C		Harbour View
<b>Harkness Street</b>	<b>Even</b>				
Harkness Street	2	Federation house	C		Harbour View
Harkness Street	4	Federation house	C		Harbour View
Harkness Street	6	Federation house	C		Harbour View
Harkness Street	8	Federation house	C		Harbour View
Harkness Street	10	Federation house	C		Harbour View
Harkness Street	12	Federation house	C		Harbour View
<b>Holdsworth Street</b>	<b>Odd</b>				
Holdsworth Street	27	Victorian terrace house	C	1 of 3	W Woollahra
Holdsworth Street	29	Victorian terrace house	C	2 of 3	W Woollahra
Holdsworth Street	31	Victorian terrace house	C	3 of 3	W Woollahra
Holdsworth Street	35	Victorian semi-detached house	C	1 of 2	W Woollahra
Holdsworth Street	37	Victorian semi-detached house	C	2 of 2	W Woollahra
Holdsworth Street	39	Victorian house	C		W Woollahra
Holdsworth Street	41	Victorian semi-detached house	C	1 of 2	W Woollahra
Holdsworth Street	43	Victorian semi-detached house	C	2 of 2	W Woollahra
Holdsworth Street	45	Victorian semi-detached house	C	1 of 2	W Woollahra
Holdsworth Street	47	Victorian semi-detached house	C	2 of 2	W Woollahra
Holdsworth Street	49	Victorian terrace house	C	1 of 3	W Woollahra
Holdsworth Street	51	Victorian terrace house	C	2 of 3	W Woollahra
Holdsworth Street	53	Victorian terrace house	C	3 of 3	W Woollahra
Holdsworth Street	57	Victorian terrace house	C	1 of 4	W Woollahra
Holdsworth Street	59	Victorian terrace house	C	2 of 4	W Woollahra
Holdsworth Street	61	Victorian terrace house	C	3 of 4	W Woollahra
Holdsworth Street	63	Victorian terrace house	C	4 of 4	W Woollahra
Holdsworth Street	65	Victorian house	C		W Woollahra
Holdsworth Street	67	Victorian semi-detached house	C	1 of 2	W Woollahra
Holdsworth Street	69	Victorian semi-detached house	C	2 of 2	W Woollahra
Holdsworth Street	71	Victorian semi-detached house	C	1 of 2	W Woollahra
Holdsworth Street	73	Victorian semi-detached house	C	2 of 2	W Woollahra

Street	Street number	Description	H or C	Group element	Precinct
Holdsworth Street	75	Victorian semi-detached house	C	1 of 2	W Woollahra
Holdsworth Street	77	Victorian semi-detached house	C	2 of 2	W Woollahra
Holdsworth Street	79	Victorian house	C		W Woollahra
Holdsworth Street	81-83	Inter-War flat building	C		W Woollahra
Holdsworth Street	85	Inter-War flat building	C		W Woollahra
Holdsworth Street	89	Victorian house	C		W Woollahra
Holdsworth Street	91	Victorian house	C		W Woollahra
Holdsworth Street	93	Victorian semi-detached house	C	1 of 2	W Woollahra
Holdsworth Street	95	Victorian semi-detached house	C	2 of 2	W Woollahra
Holdsworth Street	97	Victorian house	C		W Woollahra
<b>Holdsworth Street</b>	<b>Even</b>				
Holdsworth Street	4	Victorian house	C		W Woollahra
Holdsworth Street	6	Victorian house	C		W Woollahra
Holdsworth Street	8	Victorian house	C		W Woollahra
Holdsworth Street	10	Victorian semi-detached house	C	1 of 2	W Woollahra
Holdsworth Street	12	Victorian semi-detached house	C	2 of 2	W Woollahra
Holdsworth Street	16	Victorian house	C		W Woollahra
Holdsworth Street	20	Victorian semi-detached house	C	1 of 2	W Woollahra
Holdsworth Street	22	Victorian semi-detached house	C	2 of 2	W Woollahra
Holdsworth Street	24	Victorian house	C		W Woollahra
Holdsworth Street	28	Victorian house	C		W Woollahra
Holdsworth Street	32	Victorian terrace house	C	1 of 4	W Woollahra
Holdsworth Street	34	Victorian terrace house	C	2 of 4	W Woollahra
Holdsworth Street	36	Victorian terrace house	C	3 of 4	W Woollahra
Holdsworth Street	38	Victorian terrace house	C	4 of 4	W Woollahra
Holdsworth Street	40	Victorian corner shop	C		W Woollahra
Holdsworth Street	50-64	Element - garden or park	C		W Woollahra
Holdsworth Street	66	Victorian house	C		W Woollahra
Holdsworth Street	68	Victorian semi-detached house	C	1 of 2	W Woollahra
Holdsworth Street	70	Victorian semi-detached house	C	2 of 2	W Woollahra
Holdsworth Street	72	Victorian semi-detached house	C	1 of 2	W Woollahra
Holdsworth Street	74	Victorian semi-detached house	C	2 of 2	W Woollahra

Street	Street number	Description	H or C	Group element	Precinct
Holdsworth Street	78	Victorian terrace house	C	1 of 4	W Woollahra
Holdsworth Street	80	Victorian terrace house	C	2 of 4	W Woollahra
Holdsworth Street	82	Victorian terrace house	C	3 of 4	W Woollahra
Holdsworth Street	84	Victorian terrace house	C	4 of 4	W Woollahra
<b>James Street</b>	<b>Odd</b>				
James Street	1	Victorian house	C		W Woollahra
James Street	3	Victorian terrace house	C	1 of 3	W Woollahra
James Street	5	Victorian terrace house	C	2 of 3	W Woollahra
James Street	7	Victorian terrace house	C	3 of 3	W Woollahra
James Street	9	Victorian house	C		W Woollahra
James Street	11	Victorian house	C		W Woollahra
James Street	13	Victorian semi-detached house	C	1 of 2	W Woollahra
James Street	15	Victorian semi-detached house	C	2 of 2	W Woollahra
James Street	17	Victorian semi-detached house	C	1 of 2	W Woollahra
James Street	19	Victorian semi-detached house	C	2 of 2	W Woollahra
<b>James Street</b>	<b>Even</b>				
James Street	2	Victorian semi-detached house	C	1 of 2	W Woollahra
James Street	4	Victorian semi-detached house	C	2 of 2	W Woollahra
James Street	6	Victorian house	C		W Woollahra
James Street	8	Victorian terrace house	C	1 of 3	W Woollahra
James Street	10	Victorian terrace house	C	2 of 3	W Woollahra
James Street	12	Victorian terrace house	C	3 of 3	W Woollahra
James Street	14	Victorian house	C		W Woollahra
James Street	16	Victorian house	C		W Woollahra
James Street	18	Victorian house	C		W Woollahra
<b>Jersey Road</b>	<b>Odd</b>				
Jersey Road	3	Victorian shop	C		W Woollahra
Jersey Road	5	Victorian semi-detached house	C	1 of 2	W Woollahra
Jersey Road	7	Victorian semi-detached house	C	2 of 2	W Woollahra



Street	Street number	Description	H or C	Group element	Precinct
Jersey Road	9	Victorian terrace house	C	1 of 4	W Woollahra
Jersey Road	11	Victorian terrace house	C	2 of 4	W Woollahra
Jersey Road	11a	Victorian terrace house	C	3 of 4	W Woollahra
Jersey Road	15	Victorian terrace house	C	4 of 4	W Woollahra
Jersey Road	25	Victorian terrace house	C	1 of 3	W Woollahra
Jersey Road	27	Victorian terrace house	C	2 of 3	W Woollahra
Jersey Road	29	Victorian terrace house	C	3 of 3	W Woollahra
Jersey Road	37	Victorian house	C		W Woollahra
Jersey Road	41	Victorian house	C		W Woollahra
Jersey Road	43	Victorian semi-detached house	C	1 of 2	W Woollahra
Jersey Road	45	Victorian semi-detached house	C	2 of 2	W Woollahra
Jersey Road	47	Victorian semi-detached house	C	1 of 2	W Woollahra
Jersey Road	49	Victorian semi-detached house	C	2 of 2	W Woollahra
Jersey Road	51	Victorian house	C		W Woollahra
Jersey Road	53	Victorian shop and semi-detached house	C	1 of 2	W Woollahra
Jersey Road	55	Victorian semi-detached house	C	2 of 2	W Woollahra
Jersey Road	57	Victorian semi-detached house	C	1 of 2	W Woollahra
Jersey Road	59	Victorian shop and semi-detached house	C	2 of 2	W Woollahra
Jersey Road	61	Victorian house	C		W Woollahra
Jersey Road	63	Federation building	C		W Woollahra
Jersey Road	65	Element - garden or park	C		W Woollahra
Jersey Road	67	Victorian house and Victorian shop	C		W Woollahra
Jersey Road	77	Victorian terrace house	C	1 of 5	W Woollahra
Jersey Road	79	Victorian terrace house	C	2 of 5	W Woollahra
Jersey Road	81	Victorian terrace house	C	3 of 5	W Woollahra
Jersey Road	83	Victorian terrace house	C	4 of 5	W Woollahra
Jersey Road	85	Victorian terrace house	C	5 of 5	W Woollahra

Street	Street number	Description	H or C	Group element	Precinct
Jersey Road	87	Victorian terrace house	C	1 of 5	W Woollahra
Jersey Road	89	Victorian terrace house	C	2 of 5	W Woollahra
Jersey Road	91	Victorian terrace house	C	3 of 5	W Woollahra
Jersey Road	93	Victorian terrace house	C	4 of 5	W Woollahra
Jersey Road	95	Victorian terrace house	C	5 of 5	W Woollahra
Jersey Road	97	Victorian house	C		W Woollahra
Jersey Road	99	Victorian house	C		W Woollahra
Jersey Road	101	Victorian terrace house	C	1 of 4	W Woollahra
Jersey Road	103	Victorian terrace house	C	2 of 4	W Woollahra
Jersey Road	105	Victorian terrace house	C	3 of 4	W Woollahra
Jersey Road	107	Victorian terrace house	C	4 of 4	W Woollahra
Jersey Road	109	Victorian house	C		W Woollahra
Jersey Road	113	Victorian semi-detached house	C	1 of 2	W Woollahra
Jersey Road	115	Victorian semi-detached house	C	2 of 2	W Woollahra
Jersey Road	117	Victorian shop	C		W Woollahra
Jersey Road	119	Victorian terrace house	C	1 of 9	W Woollahra
Jersey Road	121	Victorian terrace house	C	2 of 9	W Woollahra
Jersey Road	123	Victorian terrace house	C	3 of 9	W Woollahra
Jersey Road	125	Victorian terrace house	C	4 of 9	W Woollahra
Jersey Road	127	Victorian terrace house	C	5 of 9	W Woollahra
Jersey Road	129	Victorian terrace house	C	6 of 9	W Woollahra
Jersey Road	131	Victorian terrace house	C	7 of 9	W Woollahra
Jersey Road	133	Victorian terrace house	C	8 of 9	W Woollahra
Jersey Road	135	Victorian terrace house	C	9 of 9	W Woollahra
<b>John Street</b>	<b>Odd</b>				
John Street	5	Victorian semi-detached house	C	1 of 2	W Woollahra
John Street	7	Victorian semi-detached house	C	2 of 2	W Woollahra
John Street	9	Victorian house	C		W Woollahra
John Street	13	Victorian house	C		W Woollahra

Street	Street number	Description	H or C	Group element	Precinct
John Street	15	Victorian terrace house	C	1 of 5	W Woollahra
John Street	17	Victorian terrace house	C	2 of 5	W Woollahra
John Street	19	Victorian terrace house	C	3 of 5	W Woollahra
John Street	21	Victorian terrace house	C	4 of 5	W Woollahra
John Street	23	Victorian terrace house	C	5 of 5	W Woollahra
John Street	25	Victorian terrace house	C	1 of 5	W Woollahra
John Street	27	Victorian terrace house	C	2 of 5	W Woollahra
John Street	29	Victorian terrace house	C	3 of 5	W Woollahra
John Street	31	Victorian terrace house	C	4 of 5	W Woollahra
John Street	33	Victorian terrace house	C	5 of 5	W Woollahra
John Street	35	Victorian terrace house	C	1 of 5	W Woollahra
John Street	37	Victorian terrace house	C	2 of 5	W Woollahra
John Street	39	Victorian terrace house	C	3 of 5	W Woollahra
John Street	41	Victorian terrace house	C	4 of 5	W Woollahra
John Street	43	Victorian terrace house	C	5 of 5	W Woollahra
John Street	49	Federation house	C		W Woollahra
John Street	51	Victorian house	C		W Woollahra
John Street	53	Victorian house	C		W Woollahra
John Street	55	Victorian terrace house	C	1 of 3	W Woollahra
John Street	57	Victorian terrace house	C	2 of 3	W Woollahra
John Street	59	Victorian terrace house	C	3 of 3	W Woollahra
John Street	65	Victorian terrace house	C	1 of 4	W Woollahra
John Street	67	Victorian terrace house	C	2 of 4	W Woollahra
John Street	69	Victorian terrace house	C	3 of 4	W Woollahra
John Street	71	Victorian terrace house	C	4 of 4	W Woollahra
John Street	77	Victorian house	C		W Woollahra
John Street	79	Victorian terrace house	C	1 of 2	W Woollahra
John Street	81	Victorian terrace house	C	2 of 2	W Woollahra

Street	Street number	Description	H or C	Group element	Precinct
John Street	83	Victorian terrace house	C	1 of 9	W Woollahra
John Street	85	Victorian terrace house	C	2 of 9	W Woollahra
John Street	87	Victorian terrace house	C	3 of 9	W Woollahra
John Street	89	Victorian terrace house	C	4 of 9	W Woollahra
John Street	91	Victorian terrace house	C	5 of 9	W Woollahra
John Street	93	Victorian terrace house	C	6 of 9	W Woollahra
John Street	95	Victorian terrace house		7 of 9	W Woollahra
John Street	97	Victorian terrace house		8 of 9	W Woollahra
John Street	99	Victorian terrace house	C	9 of 9	W Woollahra
<b>John Street</b>	<b><i>Even</i></b>				
John Street	4	Victorian terrace house	C	1 of 4	W Woollahra
John Street	6	Victorian terrace house	C	2 of 4	W Woollahra
John Street	10	Victorian terrace house	C	3 of 4	W Woollahra
John Street	12	Victorian terrace house	C	4 of 4	W Woollahra
John Street	14	Victorian semi-detached house	C	1 of 2	W Woollahra
John Street	16	Victorian semi-detached house	C	2 of 2	W Woollahra
John Street	20	Victorian terrace house	C	1 of 3	W Woollahra
John Street	22	Victorian terrace house	C	2 of 3	W Woollahra
John Street	24	Victorian terrace house	C	3 of 3	W Woollahra
John Street	26	Victorian house	C		W Woollahra
John Street	28	Victorian house	C		W Woollahra
John Street	30	Victorian terrace	C	1 of 3	W Woollahra
John Street	32	Victorian terrace	C	2 of 3	W Woollahra
John Street	34	Victorian terrace	C	3 of 3	W Woollahra
John Street	36	Victorian house	C		W Woollahra
John Street	38	Victorian house	C		W Woollahra
John Street	40	Victorian house	C		W Woollahra
John Street	42	Victorian house	C		W Woollahra
John Street	46	Victorian house	C		W Woollahra
John Street	48	Victorian house	C		W Woollahra
John Street	58	Late 20th century house	C		W Woollahra
John Street	62	Victorian house	C		W Woollahra

Street	Street number	Description	H or C	Group element	Precinct
John Street	66	Victorian semi-detached house	C	1 of 2	W Woollahra
John Street	68	Victorian semi-detached house	C	2 of 2	W Woollahra
John Street	70	Victorian house	C		W Woollahra
John Street	72	Victorian semi-detached house	C	1 of 2	W Woollahra
John Street	74	Victorian semi-detached house	C	2 of 2	W Woollahra
John Street	78	Victorian house	C		W Woollahra
John Street	80	Victorian house	C		W Woollahra
John Street	82	Victorian house	C		W Woollahra
John Street	86	Victorian house	C		W Woollahra
John Street	90	Victorian house	C		W Woollahra
<b>Junction Street</b>	<b>Odd</b>				
Junction Street	3	Victorian terrace house	C	1 of 3	Grafton
Junction Street	5	Victorian terrace house	C	2 of 3	Grafton
Junction Street	7	Victorian terrace house	C	3 of 3	Grafton
Junction Street	9	Victorian house	C		Grafton
Junction Street	11	Victorian house	C		Grafton
Junction Street	13	Victorian house	C		Grafton
Junction Street	15	Victorian house	C		Grafton
Junction Street	17	Victorian house	C		Grafton
Junction Street	19	Victorian house	C		Grafton
Junction Street	21	Victorian terrace house	C	1 of 3	Grafton
Junction Street	23	Victorian terrace house	C	2 of 3	Grafton
Junction Street	25	Victorian terrace house	C	3 of 3	Grafton
Junction Street	27	Victorian house	C		Grafton
<b>Junction Street</b>	<b>Even</b>				
Junction Street	6	Victorian terrace house		1 of 3	Grafton
Junction Street	8	Victorian terrace house		2 of 3	Grafton
Junction Street	10	Victorian terrace house		3 of 3	Grafton
Junction Street	12	Victorian house	C		Grafton
Junction Street	14	Victorian house	C		Grafton
Junction Street	16	Victorian house	C		Grafton
Junction Street	18	Victorian house	C		Grafton

Street	Street number	Description	H or C	Group element	Precinct
Junction Street	20	Victorian house	C		Grafton
Junction Street	22	Victorian house	C		Grafton
Junction Street	24	Victorian house	C		Grafton
Junction Street	26	Victorian house	C		Grafton
Junction Street	28	Inter-War flat building	C		Grafton
<b>Kendall Street</b>	<i>Even</i>				
Kendall Street	4	Victorian house	C		Fletcher
Kendall Street	8	Federation house	C		Fletcher
Kendall Street	10	Inter-War house	C		Fletcher
Kendall Street	14	Victorian house	C		Fletcher
Kendall Street	16	Victorian house	C		Fletcher
Kendall Street	18	Inter-War flat building	C		Fletcher
<b>Kilminster Lane</b>	<i>Odd</i>				
Kilminster Lane		Elms reserve	C		W Woollahra
<b>Magney Street</b>	<i>Odd</i>				
Magney Street	1	Federation house	C		Harbour View
Magney Street	3	Federation house	C		Harbour View
Magney Street	5	Federation house	C		Harbour View
Magney Street	7	Federation house	C		Harbour View
Magney Street	9	Federation house	C		Harbour View
Magney Street	11	Federation house	C		Harbour View
<b>Magney Street</b>	<i>Even</i>				
Magney Street	2	Federation house	C		Harbour View
Magney Street	4	Federation house	C		Harbour View
Magney Street	6	Federation house	C		Harbour View
Magney Street	8	Federation house	C		Harbour View

Street	Street number	Description	H or C	Group element	Precinct
<b>Moncur Street</b>	<b>Odd</b>				
Moncur Street	1	Victorian hotel	C		W Woollahra
Moncur Street	3	Victorian terrace house	C	1 of 12	W Woollahra
Moncur Street	5	Victorian terrace house	C	2 of 12	W Woollahra
Moncur Street	7	Victorian terrace house	C	3 of 12	W Woollahra
Moncur Street	9	Victorian terrace house	C	4 of 12	W Woollahra
Moncur Street	11	Victorian terrace house	C	5 of 12	W Woollahra
Moncur Street	13	Victorian terrace house	C	6 of 12	W Woollahra
Moncur Street	15	Victorian terrace house	C	7 of 12	W Woollahra
Moncur Street	17	Victorian terrace house	C	8 of 12	W Woollahra
Moncur Street	19	Victorian terrace house	C	9 of 12	W Woollahra
Moncur Street	21	Victorian terrace house	C	10 of 12	W Woollahra
Moncur Street	23	Victorian terrace house	C	11 of 12	W Woollahra
Moncur Street	25	Victorian terrace house	C	12 of 12	W Woollahra
Moncur Street	27	Victorian corner shop	C	1 of 4	W Woollahra
Moncur Street	29	Victorian terrace house	C	2 of 4	W Woollahra
Moncur Street	31	Victorian terrace house	C	3 of 4	W Woollahra
Moncur Street	33	Victorian terrace house	C	4 of 4	W Woollahra
Moncur Street	35	Victorian house	C		W Woollahra
Moncur Street	37	Victorian semi-detached house	C	1 of 2	W Woollahra
Moncur Street	39	Victorian semi-detached house	C	2 of 2	W Woollahra
Moncur Street	41	Victorian semi-detached house	C	1 of 2	W Woollahra
Moncur Street	43	Victorian semi-detached house	C	2 of 2	W Woollahra
Moncur Street	45	Victorian terrace house	C	1 of 4	W Woollahra
Moncur Street	47	Victorian terrace house	C	2 of 4	W Woollahra
Moncur Street	49	Victorian terrace house	C	3 of 4	W Woollahra
Moncur Street	51	Victorian terrace house	C	4 of 4	W Woollahra
Moncur Street	53	Victorian house	C		Queen St

Street	Street number	Description	H or C	Group element	Precinct
Moncur Street	61	Victorian terrace house	C	1 of 5	W Woollahra
Moncur Street	63	Victorian terrace house	C	2 of 5	W Woollahra
Moncur Street	65	Victorian terrace house	C	3 of 5	W Woollahra
Moncur Street	67	Victorian terrace house	C	4 of 5	W Woollahra
Moncur Street	69	Victorian terrace house	C	5 of 5	W Woollahra
Moncur Street	71	Victorian semi-detached house	C	1 of 2	W Woollahra
Moncur Street	73	Victorian semi-detached house	C	2 of 2	W Woollahra
Moncur Street	75	Victorian house	C		W Woollahra
Moncur Street	81-83	Inter-War flat building	C		W Woollahra
Moncur Street	85	Victorian house	C		W Woollahra
Moncur Street	87	Victorian house	C		W Woollahra
Moncur Street	89	Victorian house	C		W Woollahra
Moncur Street		Holdsworth reserve	C		W Woollahra
Moncur Street	101	Victorian house	C		W Woollahra
Moncur Street	103	Victorian house	C		W Woollahra
<b>Moncur Street</b>	<b>Even</b>				
Moncur Street	2	Victorian corner shop	C		W Woollahra
Moncur Street	4	Victorian semi-detached house	C	1 of 2	W Woollahra
Moncur Street	6	Victorian semi-detached house	C	2 of 2	W Woollahra
Moncur Street	8	Victorian house	C		W Woollahra
Moncur Street	10	Victorian semi-detached house	C	1 of 2	W Woollahra
Moncur Street	12	Victorian semi-detached house	C	2 of 2	W Woollahra
Moncur Street	16	Victorian house	C		W Woollahra
Moncur Street	18	Victorian terrace house	C	1 of 4	W Woollahra
Moncur Street	20	Victorian terrace house	C	2 of 4	W Woollahra
Moncur Street	22	Victorian terrace house	C	3 of 4	W Woollahra
Moncur Street	24	Victorian terrace house	C	4 of 4	W Woollahra
Moncur Street	48	Victorian house	C		W Woollahra
Moncur Street	50	Victorian terrace house	C	1 of 3	W Woollahra
Moncur Street	52	Victorian terrace house	C	2 of 3	W Woollahra
Moncur Street	54	Victorian terrace house	C	3 of 3	W Woollahra



Street	Street number	Description	H or C	Group element	Precinct
Moncur Street	56	Victorian house	C		W Woollahra
Moncur Street	66	Victorian house	C		W Woollahra
Moncur Street	70	Victorian terrace house	C	1 of 3	W Woollahra
Moncur Street	72	Victorian terrace house	C	2 of 3	W Woollahra
Moncur Street	74	Victorian terrace house	C	3 of 3	W Woollahra
Moncur Street	76	Victorian house	C		W Woollahra
Moncur Street	80	Victorian terrace house	C	1 of 4	W Woollahra
Moncur Street	82	Victorian terrace house	C	2 of 4	W Woollahra
Moncur Street	84	Victorian terrace house	C	3 of 4	W Woollahra
Moncur Street	86	Victorian terrace house	C	4 of 4	W Woollahra
Moncur Street	88	Victorian semi-detached house	C	1 of 2	W Woollahra
Moncur Street	90	Victorian semi-detached house	C	2 of 2	W Woollahra
<b>Morrell Street</b>	<b>Odd</b>				
Morrell Street		Holdsworth reserve	C		W Woollahra
Morrell Street	11	Victorian house	C		W Woollahra
Morrell Street	13	Victorian house	C		W Woollahra
Morrell Street	15	Victorian house	C		W Woollahra
<b>Nelson Street</b>	<b>Odd</b>				
Nelson Street	19	Federation house	C		Nelson
Nelson Street	21	Federation house	C		Nelson
Nelson Street	29	Inter-War flat building	C	1 of 4	Nelson
Nelson Street	29a	Inter-War flat building	C	2 of 4	Nelson
Nelson Street	29b	Inter-War flat building	C	3 of 4	Nelson
Nelson Street	29c	Inter-War flat building	C	4 of 4	Nelson
Nelson Street	33	Inter-War flat building	C		Nelson
Nelson Street	35	Inter-War flat building	C		Nelson
Nelson Street	37	Inter-War flat building	C		Nelson
Nelson Street	39	Inter-War flat building	C		Nelson
<b>Nelson Street</b>	<b>Even</b>				
Nelson Street	6	Victorian house	C		Nelson
Nelson Street	12	Victorian house	C		Nelson
Nelson Street	14	Victorian house	C		Nelson

Street	Street number	Description	H or C	Group element	Precinct
Nelson Street	16	Victorian house	C		Nelson
Nelson Street	18	Victorian house	C		Nelson
<b>Ocean Street</b>	<b>Odd</b>				
Ocean Street	1	Inter-War flat building	C		Nelson
Ocean Street	3	Inter-War flat building	C		Nelson
Ocean Street	5	Inter-War flat building	C		Nelson
Ocean Street	11	Victorian house	C		W Woollahra
Ocean Street	17	Victorian house	C		W Woollahra
Ocean Street	19	Victorian house	C		W Woollahra
Ocean Street	21	Victorian house	C		W Woollahra
Ocean Street	23	Victorian house	C		W Woollahra
Ocean Street	25	Victorian house	C		W Woollahra
Ocean Street	35	Victorian house	C		W Woollahra
Ocean Street	37	Victorian shop	C	1 of 2	W Woollahra
Ocean Street	39	Victorian shop	C	2 of 2	W Woollahra
Ocean Street	41	Victorian shop	C		W Woollahra
Ocean Street	43	Victorian house	C		W Woollahra
Ocean Street	45	Victorian house	C		W Woollahra
Ocean Street	49	Victorian house	C		W Woollahra
Ocean Street	51	Victorian house	C		W Woollahra
Ocean Street	53	Victorian corner shop	C		W Woollahra
Ocean Street	63	Chiswick Park - Inter-War park associated with 65 Ocean Street.	C		Rosemont
Ocean Street	65	Inter-War commercial building	C		Rosemont
Ocean Street	69-71	Inter-War flat building	C		Rosemont
Ocean Street	69-71	(Front fence associated with Victorian house, now demolished).	C		Rosemont
Ocean Street	85a	Inter-War flat building	C	1 of 4	Rosemont
Ocean Street	85b	Inter-War flat building	C	2 of 4	Rosemont
Ocean Street	85c	Inter-War flat building	C	3 of 4	Rosemont
Ocean Street	87	Inter-War flat building	C	4 of 4	Rosemont
Ocean Street	97	Victorian semi-detached house	C	1 of 2	Rosemont
Ocean Street	99	Victorian semi-detached house	C	2 of 2	Rosemont

Street	Street number	Description	H or C	Group element	Precinct
Ocean Street	101	Victorian semi-detached house	C	1 of 2	Rosemont
Ocean Street	103	Victorian semi-detached house	C	2 of 2	Rosemont
Ocean Street	105	Victorian semi-detached house	C	1 of 2	Rosemont
Ocean Street	107	Victorian semi-detached house	C	2 of 2	Rosemont
Ocean Street	109	Victorian semi-detached house	C	1 of 2	Rosemont
Ocean Street	111	Victorian semi-detached house	C	2 of 2	Rosemont
<b>Ocean Street</b>	<b>Even</b>				
Ocean Street	2a	Inter-War house	C		W Woollahra
Ocean Street	2	Federation terrace house	C	1 of 3	W Woollahra
Ocean Street	4	Federation terrace house	C	2 of 3	W Woollahra
Ocean Street	6	Federation terrace house	C	3 of 3	W Woollahra
Ocean Street	8-10	Victorian terraces	C		W Woollahra
Ocean Street	14	Victorian semi-detached house	C	1 of 2	W Woollahra
Ocean Street	16	Victorian semi-detached house	C	2 of 2	W Woollahra
Ocean Street, corner of Queen Street		Norfolk Island Pine	H		Queen St
Ocean Street	42	Victorian shop	C	1 of 3	Rosemont
Ocean Street	44	Victorian shop	C	2 of 3	Rosemont
Ocean Street	46	Victorian shop	C	3 of 3	Rosemont
Ocean Street	48	Victorian semi-detached house	C	1 of 2	Rosemont
Ocean Street	50	Victorian semi-detached house	C	2 of 2	Rosemont
Ocean Street	52	Victorian semi-detached house	C	1 of 2	Rosemont
Ocean Street	54	Victorian semi-detached house	C	2 of 2	Rosemont
Ocean Street	56	Federation house	C		Rosemont
Ocean Street	66	Federation house	C		Rosemont
Ocean Street	68-70	Victorian house	C		Rosemont
Ocean Street	72	Federation semi-detached house	C	1 of 2	Rosemont
Ocean Street	74	Federation semi-detached house	C	2 of 2	Rosemont
Ocean Street	84	Victorian house	C		Rosemont
Ocean Street <i>See also 14a Trelawney St</i>	86	Victorian house	C		Rosemont

Street	Street number	Description	H or C	Group element	Precinct
<b>Old South Head Road</b>	<i>Even</i>				
Old South Head Rd	76	Victorian/Federation house	C		Grafton
Old South Head Rd	78	Inter-War flat building	C		Grafton
Old South Head Rd	80	Victorian house	C		Grafton
Old South Head Rd	82	Federation terrace house	C	1 of 4	Grafton
Old South Head Rd	82a	Federation terrace house	C	2 of 4	Grafton
Old South Head Rd	84	Federation terrace house	C	3 of 4	Grafton
Old South Head Rd	86	Federation terrace house	C	4 of 4	Grafton
Old South Head Rd	90	Victorian terrace house	C	1 of 6	Grafton
Old South Head Rd	92	Victorian terrace house	C	2 of 6	Grafton
Old South Head Rd	94	Victorian terrace house	C	3 of 6	Grafton
Old South Head Rd	96	Victorian terrace house	C	4 of 6	Grafton
Old South Head Rd	98	Victorian terrace house	C	5 of 6	Grafton
Old South Head Rd	100	Victorian terrace house	C	6 of 6	Grafton
Old South Head Rd	110-112	Federation house	C		Grafton
Old South Head Rd	114	Victorian house	C		Grafton
<b>Oxford Street</b>	<i>Even</i>				
Oxford Street	2	Inter-War Hotel	C		W Woollahra
Oxford Street	4	Victorian shop	C	1 of 2	W Woollahra
Oxford Street	6	Victorian shop	C	2 of 2	W Woollahra
Oxford Street	8	Victorian shop	C	1 of 2	W Woollahra
Oxford Street	10	Victorian shop	C	2 of 2	W Woollahra
Oxford Street	12-14	Federation commercial building	C		W Woollahra
Oxford Street	16	Inter-War commercial building	C		W Woollahra
Oxford Street	20	Victorian commercial building	C		W Woollahra
Oxford Street	22-36	Inter-War building	C		W Woollahra
Oxford Street	38	Victorian house	C		W Woollahra
Oxford Street	40	Victorian semi-detached house	C	1 of 2	W Woollahra
Oxford Street	42	Victorian semi-detached house	C	2 of 2	W Woollahra
Oxford Street	44	Victorian semi-detached house	C	1 of 2	W Woollahra
Oxford Street	46	Victorian semi-detached house	C	2 of 2	W Woollahra

Street	Street number	Description	H or C	Group element	Precinct
Oxford Street	48	Inter-War garage building	C		W Woollahra
Oxford Street	50	Inter-War house	C		W Woollahra
Oxford Street	52	Victorian semi-detached house	C	1 of 2	W Woollahra
Oxford Street	54	Victorian semi-detached house	C	2 of 2	W Woollahra
Oxford Street	56	Victorian house	C		W Woollahra
Oxford Street	58	Victorian house	C		W Woollahra
Oxford Street	60	Inter-War building			W Woollahra
Oxford Street	68	Federation semi-detached house	C	1 of 2	W Woollahra
Oxford Street	70	Federation semi-detached house	C	2 of 2	W Woollahra
Oxford Street	72	Victorian semi-detached house	C	1 of 2	W Woollahra
Oxford Street	74	Victorian semi-detached house	C	2 of 2	W Woollahra
Oxford Street	76	Inter-War flat building	C		W Woollahra
Oxford Street	78	Victorian house	C		W Woollahra
Oxford Street	80	Victorian commercial building	C		W Woollahra
Oxford Street	82	Victorian terrace house	C	1 of 3	W Woollahra
Oxford Street	84	Victorian terrace house	C	2 of 3	W Woollahra
Oxford Street	86	Victorian terrace house	C	3 of 3	W Woollahra
Oxford Street	88-90	Victorian Hotel	C		W Woollahra
Oxford Street	92	Inter-War garage building	C		W Woollahra
Oxford Street	96	Victorian house	C		W Woollahra
Oxford Street	98	Victorian terrace house	C	1 of 2	W Woollahra
Oxford Street	100	Victorian terrace house	C	2 of 2	W Woollahra
Oxford Street	102	Victorian terrace house	C	1 of 3	W Woollahra
Oxford Street	104	Victorian terrace house	C	2 of 3	W Woollahra
Oxford Street	106	Victorian terrace house	C	3 of 3	W Woollahra
Oxford Street	108	Victorian house	C		W Woollahra
Oxford Street	110	Victorian house	C		W Woollahra
Oxford Street	112	Victorian house	C		W Woollahra
Oxford Street	114	Victorian semi-detached house	C	1 of 2	W Woollahra
Oxford Street	116	Victorian semi-detached house	C	2 of 2	W Woollahra
Oxford Street	118	Inter-War building	C		W Woollahra
Oxford Street	120-124	Inter-War garage building	C		W Woollahra

Street	Street number	Description	H or C	Group element	Precinct
Oxford Street	126	Victorian building	C		W Woollahra
Oxford Street	128	Victorian building	C		W Woollahra
Oxford Street	130	Victorian semi-detached house	C	1 of 2	W Woollahra
Oxford Street	132	Victorian semi-detached house	C	2 of 2	W Woollahra
Oxford Street	134	Victorian semi-detached house	C	1 of 2	W Woollahra
Oxford Street	136	Victorian semi-detached house	C	2 of 2	W Woollahra
Oxford Street	138	Victorian corner shop	C	1 of 4	W Woollahra
Oxford Street	140	Victorian terrace house	C	2 of 4	W Woollahra
Oxford Street	142	Victorian terrace house	C	3 of 4	W Woollahra
Oxford Street	144	Victorian terrace house	C	4 of 4	W Woollahra
Oxford Street	146	Victorian house	C		W Woollahra
Oxford Street	148	Victorian semi-detached house	C	1 of 2	W Woollahra
Oxford Street	150	Victorian semi-detached house	C	2 of 2	W Woollahra
Oxford Street	168	Victorian house	C		W Woollahra
Oxford Street	170	Victorian house	C		W Woollahra
Oxford Street	172-178	Inter-War religious building	C		W Woollahra
<b>Peaker Lane</b>	<i>Even</i>				
Peaker Lane	6	Victorian semi-detached house	C	1 of 2	Queen St
Peaker Lane	8	Victorian semi-detached house	C	2 of 2	Queen St
<b>Pickering Lane</b>	<i>Odd</i>				
Pickering Lane	1	Victorian semi-detached house	C	1 of 2	W Woollahra
Pickering Lane	3	Victorian semi-detached house	C	2 of 2	W Woollahra
Pickering Lane	5	Victorian timber house	C		W Woollahra
<b>Quambi Place</b>	<i>Odd</i>				
Quambi Place	1	Inter-War house	C		Rosemont
Quambi Place	3-3a	Inter-War house	C		Rosemont
Quambi Place	5	Inter-War house and gardens	H		Rosemont
Quambi Place	7	Inter-War house	C		Rosemont
Quambi Place	9-9a	Inter-War house	C		Rosemont
Quambi Place	11	Inter-War house	C		Rosemont
<b>Quambi Place</b>	<i>Even</i>				

Street	Street number	Description	H or C	Group element	Precinct
Quambi Place	2	Inter-War house	C		Rosemont
Quambi Place	10	Inter-War house	C		Rosemont
Quambi Place	12	Inter-War house	C		Rosemont
<b>Queen Street</b>	<b>Odd</b>				
Queen Street	7-9	Victorian house	C		Queen St
Queen Street	13-15	Inter-War house	C		Queen St
Queen Street	17	Victorian terrace house	C	1 of 4	Queen St
Queen Street	19	Victorian terrace house	C	2 of 4	Queen St
Queen Street	21	Federation house	C	3 of 4	Queen St
Queen Street	23	Victorian terrace house	C	4 of 4	Queen St
Queen Street	25	Victorian commercial building	C		Queen St
Queen Street	27	Federation house	C		Queen St
Queen Street	29	Victorian house	C		Queen St
Queen Street	31	Victorian terrace house	C	1 of 3	Queen St
Queen Street	33	Victorian terrace house	C	2 of 3	Queen St
Queen Street	35	Victorian terrace house	C	3 of 3	Queen St
Queen Street	37	Inter-War flat building	C	1 of 3	Queen St
Queen Street	39	Inter-War flat building	C	2 of 3	Queen St
Queen Street	41	Inter-War flat building	C	3 of 3	Queen St
Queen Street	43	Federation building	C		Queen St
Queen Street	45	Victorian house	C		Queen St
Queen Street	49	Victorian house	C		Queen St
Queen Street	53	Victorian house	C		Queen St
Queen Street	55	Victorian corner shop	C		Queen St
Queen Street	59	Victorian terrace house	C	1 of 6	Queen St
Queen Street	61	Victorian terrace house	C	2 of 6	Queen St
Queen Street	63	Victorian terrace house	C	3 of 6	Queen St
Queen Street	65	Victorian terrace house	C	4 of 6	Queen St
Queen Street	67	Victorian terrace house	C	5 of 6	Queen St
Queen Street	69	Victorian terrace house	C	6 of 6	Queen St
Queen Street	71	Victorian house	C		Queen St
Queen Street	73	Victorian semi-detached house	C	1 of 2	Queen St

Street	Street number	Description	H or C	Group element	Precinct
Queen Street	75	Victorian semi-detached house	C	2 of 2	Queen St
Queen Street	75a	Victorian terrace house	C	1 of 4	Queen St
Queen Street	77	Victorian terrace house	C	2 of 4	Queen St
Queen Street	79	Victorian terrace house	C	3 of 4	Queen St
Queen Street	81	Victorian terrace house	C	4 of 4	Queen St
Queen Street	83	Victorian shop	C	1 of 2	Queen St
Queen Street	85	Victorian shop	C	2 of 2	Queen St
Queen Street	87	Victorian terrace house	C	1 of 3	Queen St
Queen Street	89	Victorian terrace house	C	2 of 3	Queen St
Queen Street	91	Victorian terrace house	C	3 of 3	Queen St
Queen Street	93	Victorian house	C		Queen St
Queen Street	95	Federation building	C		Queen St
Queen Street	105	Victorian shop	C	1 of 2	Queen St
Queen Street	107	Victorian shop	C	2 of 2	Queen St
Queen Street	125	Victorian semi-detached house	C	1 of 2	Queen St
Queen Street	127	Victorian semi-detached house	C	2 of 2	Queen St
Queen Street	129	Victorian house	C		Queen St
Queen Street	131	Victorian house	C		Queen St
Queen Street	133	Late 20th century	C		Queen St
Queen Street	137	Inter-War flat building	C		Queen St
Queen Street	163	Inter-War flat building	C		Nelson
<b>Queen Street</b>	<b>Even</b>				
Queen Street	2a	Inter-War commercial building	C		Woollahra
Queen Street	2	Victorian terrace house	C	1 of 3	Queen St
Queen Street	4	Victorian terrace house	C	2 of 3	Queen St
Queen Street	6	Victorian terrace house	C	3 of 3	Queen St
Queen Street	8-16	Hughendon hotel, Victorian commercial building	C		Queen St
Queen Street	18	Inter-War house	C		Queen St
Queen Street	80	Victorian shop	C		Queen St
Queen Street	82	Victorian shop	C		Queen St
Queen Street	84	Victorian shop	C		Queen St



Street	Street number	Description	H or C	Group element	Precinct
Queen Street	88	Victorian shop	C	1 of 2	Queen St
Queen Street	90	Victorian shop	C	2 of 2	Queen St
Queen Street	92	Federation shop	C		Queen St
Queen Street	94	Victorian shop	C	1 of 2	Queen St
Queen Street	96	Victorian shop	C	2 of 2	Queen St
Queen Street	100	Victorian shop	C		Queen St
Queen Street	102	Victorian shop	C	1 of 3	Queen St
Queen Street	104	Victorian shop	C	2 of 3	Queen St
Queen Street	106	Victorian shop	C	3 of 3	Queen St
Queen Street	108	Victorian shop	C		Queen St
Queen Street	110	Federation shop	C		Queen St
Queen Street	118	Victorian corner shop	C		Queen St
Queen Street	126	Federation shop	C	1 of 2	Queen St
Queen Street	126a	Federation shop	C	2 of 2	Queen St
Queen Street	128	Victorian corner shop	C		Queen St
Queen Street	130	Victorian shop	C	1 of 2	Queen St
Queen Street	132	Victorian shop	C	2 of 2	Queen St
Queen Street	134	Victorian shop	C		Queen St
Queen Street	136	Victorian shop	C	1 of 2	Queen St
Queen Street	138	Victorian shop	C	2 of 2	Queen St
Queen Street	140	Victorian shop	C	1 of 2	Queen St
Queen Street	142	Victorian shop	C	2 of 2	Queen St
Queen Street	144	Victorian shop	C		Queen St
Queen Street	146	Victorian shop	C	1 of 3	Queen St
Queen Street	148	Victorian shop	C	2 of 3	Queen St
Queen Street	150	Victorian shop	C	3 of 3	Queen St
Queen Street	156	Victorian terrace	C	1 of 3	Queen St
Queen Street	158	Victorian terrace	C	2 of 3	Queen St
Queen Street	160	Victorian terrace	C	3 of 3	Queen St
Queen Street	162	Victorian shop	C		Queen St
Queen Street	162a	Victorian shop	C		Queen St
Queen Street	164	Inter-War flat building	C		Queen St

Street	Street number	Description	H or C	Group element	Precinct
Queen Street	166	Inter-War flat building	C		Queen St
Queen Street	166a	Inter-War flat building	C		Queen St
Queen Street	168	Inter-War house	C		Queen St
Queen Street	200	Inter-War flat building	C		Nelson
<b>Raine Street</b>	<b>Odd</b>				
Raine Street	1	Victorian terrace house	C	1 of 3	Fletcher
Raine Street	3	Victorian terrace house	C	2 of 3	Fletcher
Raine Street	5	Victorian terrace house	C	3 of 3	Fletcher
Raine Street	15	Inter-War flat building	C		Fletcher
<b>Raine Street</b>	<b>Even</b>				
Raine Street	4	Victorian house	C		Fletcher
Raine Street	6	Victorian house	C		Fletcher
Raine Street	20	Inter-War house	C		Fletcher
<b>Rosemont Avenue</b>	<b>Odd</b>				
Rosemont Avenue	5	Inter-War house			Rosemont
Rosemont Avenue	7	Inter-War house	C		Rosemont
Rosemont Avenue	17	Inter-War house	C		Rosemont
<b>Rosemont Avenue</b>	<b>Even</b>		C		
Rosemont Avenue	2	Inter-War house	C		Rosemont
Rosemont Avenue	4	Inter-War house	C		Rosemont
Rosemont Avenue	6-6a	Inter-War house	C		Rosemont
Rosemont Avenue	8	Inter-War house	C		Rosemont
Rosemont Avenue	10	Inter-War house	C		Rosemont
Rosemont Avenue	12	Inter-War flat building	C		Rosemont
Rosemont Avenue	20	Inter-War house	C		Rosemont
Rosemont Avenue	22	Inter-War house	C		Rosemont
Rosemont Avenue	24a	Late 20th century flat building	C		Rosemont
Rosemont Avenue	24	Inter-War flat building	C		Rosemont
<b>Roslyndale Avenue</b>	<b>Even</b>				
Roslyndale Avenue	4	Inter-War house	C		Rosemont

Street	Street number	Description	H or C	Group element	Precinct
<b>Rowe Street</b>	<b>Odd</b>				
Rowe Street	23	Victorian house	C		Grafton
Rowe Street	25	Victorian house	C		Grafton
Rowe Street	27	Victorian house	C		Grafton
Rowe Street	29	Victorian house	C		Grafton
Rowe Street	31	Victorian house	C		Grafton
Rowe Street	33	Inter-War flat building	C		Grafton
Rowe Street	37	Victorian house	C		Grafton
Rowe Street	39	Victorian semi-detached house	C	1 of 2	Grafton
Rowe Street	41	Victorian semi-detached house	C	2 of 2	Grafton
Rowe Street	43	Victorian house	C		Grafton
<b>Rush Street</b>	<b>Odd</b>				
Rush Street	5-7	Victorian house	C		W Woollahra
Rush Street	9	Victorian house	C		W Woollahra
Rush Street	11	Victorian house	C		W Woollahra
Rush Street	13	Victorian terrace house	C	1 of 5	W Woollahra
Rush Street	15	Victorian terrace house	C	2 of 5	W Woollahra
Rush Street	17	Victorian terrace house	C	3 of 5	W Woollahra
Rush Street	19	Victorian terrace house	C	4 of 5	W Woollahra
Rush Street	21	Victorian terrace house	C	5 of 5	W Woollahra
Rush Street	23	Victorian house	C		W Woollahra
Rush Street	25	Victorian semi-detached house	C	1 of 2	W Woollahra
Rush Street	27	Victorian semi-detached house	C	2 of 2	W Woollahra
Rush Street	29	Victorian terrace house	C	1 of 7	W Woollahra
Rush Street	31	Victorian terrace house	C	2 of 7	W Woollahra
Rush Street	33	Victorian terrace house	C	3 of 7	W Woollahra
Rush Street	35	Victorian terrace house	C	4 of 7	W Woollahra
Rush Street	37	Victorian terrace house	C	5 of 7	W Woollahra
Rush Street	39	Victorian terrace house	C	6 of 7	W Woollahra
Rush Street	41	Victorian terrace house	C	7 of 7	W Woollahra
Rush Street	45	Victorian house	C		W Woollahra
Rush Street	47	Victorian house	C		W Woollahra

Street	Street number	Description	H or C	Group element	Precinct
<b>Rush Street</b>	<b>Even</b>				<b>W Woollahra</b>
Rush Street	2	Victorian terrace house	C	1 of 3	W Woollahra
Rush Street	4	Victorian terrace house	C	2 of 3	W Woollahra
Rush Street	6	Victorian terrace house	C	3 of 3	W Woollahra
Rush Street	10	Victorian house	C		W Woollahra
Rush Street	12	Victorian terrace house	C	1 of 4	W Woollahra
Rush Street	14	Victorian terrace house	C	2 of 4	W Woollahra
Rush Street	16	Victorian terrace house	C	3 of 4	W Woollahra
Rush Street	18	Victorian terrace house	C	4 of 4	W Woollahra
<b>Russell Street</b>	<b>Odd</b>				
Russell Street	1	Federation house	C		Harbour View
Russell Street	3	Federation house	C		Harbour View
Russell Street	5	Federation house	C		Harbour View
Russell Street	7	Federation house	C		Harbour View
Russell Street	9	Federation house	C		Harbour View
Russell Street	11	Inter-War flat building	C		Harbour View
<b>Russell Street</b>	<b>Even</b>				
Russell Street	2	Federation house	C		Harbour View
Russell Street	4	Federation house	C		Harbour View
Russell Street	6	Federation house	C		Harbour View
Russell Street	10	Federation house	C		Harbour View
Russell Street	12	Federation house	C		Harbour View
Russell Street	14	Inter-War house	C		Harbour View
<b>Saber Street</b>	<b>Even</b>				
Saber Street	10	Victorian house	C		Grafton
Saber Street	12	Victorian house	C		Grafton
Saber Street	14	Victorian terrace house	C	1 of 4	Grafton
Saber Street	16	Victorian terrace house	C	2 of 4	Grafton
Saber Street	18	Victorian terrace house	C	3 of 4	Grafton
Saber Street	20	Victorian terrace house	C	4 of 4	Grafton
Saber Street	22	Victorian house	C		Grafton

Street	Street number	Description	H or C	Group element	Precinct
<b>Small Street</b>	<b>Odd</b>				
Small Street	1	Victorian corner shop	C	1 of 2	Fletcher
Small Street	3	Victorian house	C	2 of 2	Fletcher
Small Street	5	Victorian house	C		Fletcher
Small Street	11	Sandstone Retaining Wall	C		Fletcher
Small Street	13	Sandstone Retaining Wall	C		Fletcher
Small Street	15	Federation house	C		Fletcher
Small Street		Sandstone retaining wall to road separation	C		Fletcher
Small Street	21	Federation house	C	1 of 2	Fletcher
Small Street	23	Federation house	C	2 of 2	Fletcher
<b>Small Street</b>	<b>Even</b>				<b>Fletcher</b>
Small Street	2	Victorian house	C		Fletcher
Small Street	12	Victorian house	C		Fletcher
<b>Spicer Lane</b>	<b>Odd</b>				
Spicer Lane	7	Victorian house	C		W Woollahra
Spicer Lane	9	Victorian house	C		W Woollahra
<b>Spicer Street</b>	<b>Odd</b>				
Spicer Street	1	Victorian house	C		W Woollahra
Spicer Street	5	Victorian semi-detached house	C	1 of 2	W Woollahra
Spicer Street	7	Victorian semi-detached house	C	2 of 2	W Woollahra
Spicer Street	9	Victorian house	C		W Woollahra
Spicer Street	11	Victorian house	C		W Woollahra
Spicer Street	17	Victorian house	C		W Woollahra
Spicer Street	19	Victorian semi-detached house	C	1 of 2	W Woollahra
Spicer Street	21	Victorian semi-detached house	C	2 of 2	W Woollahra
Spicer Street	25	Victorian terrace house	C	1 of 5	W Woollahra
Spicer Street	27	Victorian terrace house	C	2 of 5	W Woollahra
Spicer Street	29	Victorian terrace house	C	3 of 5	W Woollahra
Spicer Street	31	Victorian terrace house	C	4 of 5	W Woollahra
Spicer Street	33	Victorian terrace house	C	5 of 5	W Woollahra

Street	Street number	Description	H or C	Group element	Precinct
<b>Spicer Street</b>	<b>Even</b>				
Spicer Street	14	Victorian semi-detached house	C	1 of 2	W Woollahra
Spicer Street	16	Victorian semi-detached house	C	2 of 2	W Woollahra
Spicer Street	18	Victorian semi-detached house	C	1 of 2	W Woollahra
Spicer Street	20	Victorian semi-detached house	C	2 of 2	W Woollahra
Spicer Street	22	Victorian semi-detached house	C	1 of 2	W Woollahra
Spicer Street	24	Victorian semi-detached house	C	2 of 2	W Woollahra
Spicer Street	26	Victorian semi-detached house	C	1 of 2	W Woollahra
Spicer Street	28	Victorian semi-detached house	C	2 of 2	W Woollahra
Spicer Street	30	Victorian terrace house	C	1 of 3	W Woollahra
Spicer Street	32	Victorian terrace house	C	2 of 3	W Woollahra
Spicer Street	34	Victorian terrace house	C	3 of 3	W Woollahra
Spicer Street	36	Victorian house	C		W Woollahra
Spicer Street	38	Victorian house	C		W Woollahra
<b>Tara Street</b>	<b>Odd</b>				
Tara Street	3a	Victorian house	C		W Woollahra
Tara Street	5	Victorian house	C		W Woollahra
Tara Street	7	Victorian house	C		W Woollahra
Tara Street	9	Victorian house	C		W Woollahra
Tara Street	11a	Victorian building	C		W Woollahra
<b>The Grove</b>	<b>Even</b>				
The Grove	1-4	See No. 153a Queen Street	H		Nelson
<b>Trelawney Street</b>	<b>Odd</b>				
Trelawney Street	3	Inter-War flat building	C		Rosemont
Trelawney Street	9	Inter-War house	C		Rosemont
Trelawney Street	13	Federation house	C		Rosemont
Trelawney Street	15	Victorian house	C		Rosemont
Trelawney Street	17	Victorian house	C		Rosemont
Trelawney Street	19	Victorian house	C		Rosemont
Trelawney Street	21	Victorian house	C		Rosemont

Street	Street number	Description	H or C	Group element	Precinct
<b>Trelawney Street</b>	<i>Even</i>				
Trelawney Street	12a	Inter-War house	C		Rosemont
Trelawney Street	14	Victorian house	C		Rosemont
Trelawney Street	14a	Victorian house	C		W Woollahra
Trelawney Street See also 86 Ocean Street	16	Victorian house	C		W Woollahra
<b>Vernon Street</b>	<i>Odd</i>				
Vernon Street	35	Victorian semi-detached house	C	1 of 2	Grafton
Vernon Street	37	Victorian semi-detached house	C	2 of 2	Grafton
<b>Vernon Street</b>	<i>Even</i>				
Vernon Street	16	Victorian house	C		Grafton
Vernon Street	18	Victorian house	C		Grafton
<b>Victoria Avenue</b>	<i>Odd</i>				
Victoria Avenue	3	Victorian semi-detached house	C	1 of 2	W Woollahra
Victoria Avenue	5	Victorian semi-detached house	C	2 of 2	W Woollahra
Victoria Avenue	7	Victorian terrace house	C	1 of 3	W Woollahra
Victoria Avenue	9	Victorian terrace house	C	2 of 3	W Woollahra
Victoria Avenue	11	Victorian terrace house	C	3 of 3	W Woollahra
Victoria Avenue	13	Victorian corner shop	C		W Woollahra
Victoria Avenue	15	Victorian terrace house	C	1 of 3	W Woollahra
Victoria Avenue	17	Victorian terrace house	C	2 of 3	W Woollahra
Victoria Avenue	19	Victorian terrace house	C	3 of 3	W Woollahra
Victoria Avenue	21	Victorian house	C		Queen Street
<b>Victoria Avenue</b>	<i>Even</i>				
Victoria Avenue	2	Victorian house	C		W Woollahra
Victoria Avenue	4	Victorian semi-detached house	C	1 of 2	W Woollahra
Victoria Avenue	6	Victorian semi-detached house	C	2 of 2	W Woollahra
Victoria Avenue	10	Victorian house	C		W Woollahra

Street	Street number	Description	H or C	Group element	Precinct
<b>View Street</b>	<b>Odd</b>				
View Street	1	Victorian house	C		Fletcher
View Street	3	Victorian house	C	1 of 4	Fletcher
View Street	5	Victorian house	C	2 of 4	Fletcher
View Street	7	Victorian house	C	3 of 4	Fletcher
View Street	9	Victorian house	C	4 of 4	Fletcher
View Street	11	Federation terrace house	C	1 of 4	Fletcher
View Street	13	Federation terrace house	C	2 of 4	Fletcher
View Street	15	Federation terrace house	C	3 of 4	Fletcher
View Street	17	Federation terrace house	C	4 of 4	Fletcher
View Street	19	Victorian house	C		Fletcher
View Street	21	Victorian terrace house	C	1 of 17	Fletcher
View Street	23	Victorian terrace house	C	2 of 17	Fletcher
View Street	25	Victorian terrace house	C	3 of 17	Fletcher
View Street	27	Victorian terrace house	C	4 of 17	Fletcher
View Street	29	Victorian terrace house	C	5 of 17	Fletcher
View Street	31	Victorian terrace house	C	6 of 17	Fletcher
View Street	33	Victorian terrace house	C	7 of 17	Fletcher
View Street	35	Victorian terrace house	C	8 of 17	Fletcher
View Street	37	Victorian terrace house	C	9 of 17	Fletcher
View Street	39	Victorian terrace house	C	10 of 17	Fletcher
View Street	41	Victorian terrace house	C	11 of 17	Fletcher
View Street	43	Victorian terrace house	C	12 of 17	Fletcher
View Street	45	Victorian terrace house	C	13 of 17	Fletcher
View Street	47	Victorian terrace house	C	14 of 17	Fletcher
View Street	49	Victorian terrace house	C	15 of 17	Fletcher
View Street	51	Victorian terrace house	C	16 of 17	Fletcher
View Street	53	Victorian terrace house	C	17 of 17	Fletcher
<b>View Street</b>	<b>Even</b>				
View Street	2a	Victorian house	C		Fletcher
View Street	2	Victorian house	C		Fletcher



Street	Street number	Description	H or C	Group element	Precinct
View Street	24	Victorian house	C	1 of 2	Fletcher
View Street	26	Victorian house	C	2 of 2	Fletcher
View Street	28	Victorian house	C		Fletcher
View Street	30	Victorian house	C		Fletcher
View Street	34	Inter-War semi-detached house	C	1 of 2	Fletcher
View Street	36	Inter-War semi-detached house	C	2 of 2	Fletcher
View Street	42	Victorian house	C		Fletcher
View Street	52	Victorian house	C		Fletcher
View Street	58	Victorian house	C		Fletcher
View Street	60-62	Inter-War flat building	C		Fletcher
<b>Wallaroy Road</b>	<b>Odd</b>				
Wallaroy Road aka 283 Edgecliff Road	85	Victorian house and sandstone walling	C		Rosemont
<b>Wallis Street</b>	<b>Odd</b>				
Wallis Street	113	Federation semi-detached house	C	1 of 2	Grafton
Wallis Street	115	Federation semi-detached house	C	2 of 2	Grafton
Wallis Street	121	Victorian house	C		Grafton
Wallis Street	123	Victorian house	C		Grafton
Wallis Street	129	Victorian house	C		Grafton
<b>Wallis Street</b>	<b>Even</b>				
Wallis Street	2	Victorian house	C		W Woollahra
Wallis Street	4	Victorian house	C		W Woollahra
Wallis Street	8	Victorian house	C		W Woollahra
Wallis Street	14	Victorian semi-detached house	C	1 of 2	W Woollahra
Wallis Street	16	Victorian semi-detached house	C	2 of 2	W Woollahra
Wallis Street	20	Victorian building	C	1 of 2	W Woollahra
Wallis Street	20a	Victorian building	C	2 of 2	W Woollahra
Wallis Street	28	Victorian house	C		W Woollahra

Street	Street number	Description	H or C	Group element	Precinct
Wallis Street	34	Victorian terrace house	C	1 of 4	W Woollahra
Wallis Street	36	Victorian terrace house	C	2 of 4	W Woollahra
Wallis Street	38	Victorian terrace house	C	3 of 4	W Woollahra
Wallis Street	40	Victorian terrace house	C	4 of 4	W Woollahra
Wallis Street	42	Late 20th century semi-detached house	C	1 of 2	W Woollahra
Wallis Street	44	Late 20th century semi-detached house	C	2 of 2	W Woollahra
Wallis Street	46	Victorian semi-detached house	C	1 of 2	W Woollahra
Wallis Street	48	Victorian semi-detached house	C	2 of 2	W Woollahra
Wallis Street	50	Victorian semi-detached house	C	1 of 2	W Woollahra
Wallis Street	52	Victorian semi-detached house	C	2 of 2	W Woollahra
Wallis Street	54	Victorian semi-detached house	C	1 of 2	W Woollahra
Wallis Street	56	Victorian semi-detached house	C	2 of 2	W Woollahra
Wallis Street	58	Victorian house	C		W Woollahra
Wallis Street	60	Victorian house	C		W Woollahra
Wallis Street	62	Victorian corner shop	C		W Woollahra
Wallis Street	64	Victorian corner shop	C		W Woollahra
Wallis Street	66	Victorian terrace house	C	1 of 7	W Woollahra
Wallis Street	68	Victorian terrace house	C	2 of 7	W Woollahra
Wallis Street	70	Victorian terrace house	C	3 of 7	W Woollahra
Wallis Street	72	Victorian terrace house	C	4 of 7	W Woollahra
Wallis Street	74	Victorian terrace house	C	5 of 7	W Woollahra
Wallis Street	76	Victorian terrace house	C	6 of 7	W Woollahra
Wallis Street	78	Victorian terrace house	C	7 of 7	W Woollahra
Wallis Street	80	Victorian semi-detached house	C	1 of 2	W Woollahra
Wallis Street	82	Victorian semi-detached house	C	2 of 2	W Woollahra
Wallis Street	90	Victorian house	C		W Woollahra
Wallis Street	96	Inter-War flat building	C		Nelson
Wallis Street	98	Inter-War flat building	C		Nelson
Wallis Street	100	Inter-War flat building	C		Nelson

Street	Street number	Description	H or C	Group element	Precinct
<b>Wellington Street</b>	<b><i>Odd</i></b>				
Wellington Street	1	Federation house	C		Rosemont
Wellington Street	3	Late 20 <sup>th</sup> century house	C		Rosemont
Wellington Street	5	Federation house	C		Rosemont
Wellington Street	9	Inter-War house	C		Rosemont
Wellington Street	17	Federation house	C		Rosemont
Wellington Street	19	Victorian house	C		Rosemont
<b>Wellington Street</b>	<b><i>Even</i></b>				<b>Rosemont</b>
Wellington Street	2	Inter-War flat building	C		Rosemont
Wellington Street	4	Inter-War flat building	C		Rosemont

# Chapter C3 Watsons Bay Heritage Conservation Area

Part C ► Heritage Conservation Areas

CHAPTER C3 APPROVED ON 27 APRIL 2015  
AND COMMENCED ON 23 MAY 2015

Last amended on 22 December 2023



# Chapter C3 ► Watsons Bay HCA

## Contents

<b>C3.1</b>	<b>INTRODUCTION .....</b>	<b>1</b>
	C3.1.1 Background .....	1
	C3.1.2 Land where this chapter applies.....	1
	C3.1.3 Development to which this chapter applies .....	1
	C3.1.4 Objectives .....	3
	C3.1.5 Relationship to other parts of the DCP .....	3
	C3.1.6 Definitions .....	3
	C3.1.7 How to use this chapter .....	4
<b>C3.2</b>	<b>UNDERSTANDING THE CONTEXT .....</b>	<b>7</b>
	C3.2.1 Historic context.....	7
	C3.2.2 General character description .....	9
	C3.2.3 Statement of significance.....	10
	C3.2.4 Key heritage values .....	11
	C3.2.5 Management policy.....	14
<b>C3.3</b>	<b>OBJECTIVES FOR DEVELOPMENT .....</b>	<b>16</b>
	C3.3.1 Topography and vegetation.....	17
	C3.3.2 Townscape.....	18
	C3.3.3 The waterfront.....	19
	C3.3.4 Views and vistas .....	20
	C3.3.5 Built form .....	22
	C3.3.6 Landscaping and private open space.....	26
	C3.3.7 Fences and walls.....	27
	C3.3.8 Car parking and access .....	28
	C3.3.9 Site facilities and aerial devices.....	29
	C3.3.10 Acoustic and visual privacy.....	31
<b>C3.4</b>	<b>PRECINCTS .....</b>	<b>32</b>
	C3.4.1 Precinct A: Entrance .....	33
	C3.4.2 Precinct B: Church Group .....	38
	C3.4.3 Precinct C: Vaughan Village .....	42
	C3.4.4 Precinct D: Commercial and residential flat buildings .....	47
	C3.4.5 Precinct E: Gap Road/Dunbar Street .....	54
	C3.4.6 Precinct F: Clovelly Street.....	61
	C3.4.7 Precinct G: Marine Parade North .....	66
	C3.4.8 Precinct H: Victoria Street Waterfront .....	73
	C3.4.9 Precinct J: Pacific Street Waterfront.....	80
	C3.4.10 Precinct K: Camp Cove Village .....	88
	C3.4.11 Precinct L: Salisbury Street / Hopetoun Avenue .....	96
	C3.4.12 Precinct M: Robertson Park .....	102
	C3.4.13 Precinct N: Robertson Place .....	105
	C3.4.14 Precinct O: Gibsons Beach Waterfront and Marine Parade South .....	107
	C3.4.15 Precinct P: Upper Gap Park .....	115

---

C3.4.16	Precinct Q: HMAS Watson.....	118
C3.4.17	Precinct R: Green (Laings) Point and Research Station .....	121
C3.4.18	Precinct S: Sydney Harbour National Park (Gap Bluff) .....	125
C3.4.19	Precinct T: Sydney Harbour National Park (Inner South Head) .....	128
<b>C3.5</b>	<b>GENERAL CONTROLS FOR ALL DEVELOPMENT .....</b>	<b>131</b>
C3.5.1	Topography and vegetation.....	132
C3.5.2	Townscape .....	133
C3.5.3	The waterfront.....	134
C3.5.4	Views and vistas .....	136
C3.5.5	Built form .....	138
C3.5.6	Landscaping and private open space.....	146
C3.5.7	Fences and walls.....	148
C3.5.8	Car parking and access .....	149
C3.5.9	Site facilities and aerial devices.....	151
C3.5.10	Acoustic and visual privacy.....	152
<b>C3.6</b>	<b>CONTRIBUTORY ITEMS: ADDITIONAL BUILT FORM CONTROLS .....</b>	<b>154</b>
C3.6.1	Contributory items .....	154
C3.6.2	Inter-War residential flat buildings .....	159
C3.6.3	Timber buildings.....	163
<b>C3.7</b>	<b>PUBLIC DOMAIN .....</b>	<b>166</b>
C3.7.1	Beaches, waterfront and public access.....	167
C3.7.2	Landscape elements and kerbs and gutters .....	169

---

---

## C3.1 Introduction

### C3.1.1 Background

---

Watsons Bay is an area of outstanding natural beauty with a rich cultural heritage. Its location on a narrow peninsula separating the Tasman Sea from Sydney Harbour results in it being a gateway to Sydney Harbour - one with dramatic coastlines, spectacular views and a varied landscape.

Historically, it was the third permanent European settlement of Sydney, a strategic defence site and important in its role as a marine village. This is represented in the variety of building types and remnant structures that exist in the area today. The built form of the residential and commercial areas is juxtaposed against scenic beaches and foreshore, bushland reserves and urban parks, and elevated topography.

The Watsons Bay Heritage Conservation Area (HCA) chapter of the DCP recognises the elements that contribute to the heritage significance and character of Watsons Bay and looks to ensure that new development in the area is sympathetically designed. It is not intended to prevent compatible new development from occurring in the area. Rather, it recognises the elements that contribute to the heritage significance and character of Watsons Bay and seeks to guide how these can be developed and managed in a positive way to enhance the values of the area.

### C3.1.2 Land where this chapter applies

---

This chapter applies to the land identified in Map 1 on the following page.

This predominantly comprises land identified as the Watsons Bay HCA in Woollahra Local Environmental Plan 2014 (Woollahra LEP 2014), but also includes other land, such as HMAS Watson.

### C3.1.3 Development to which this chapter applies

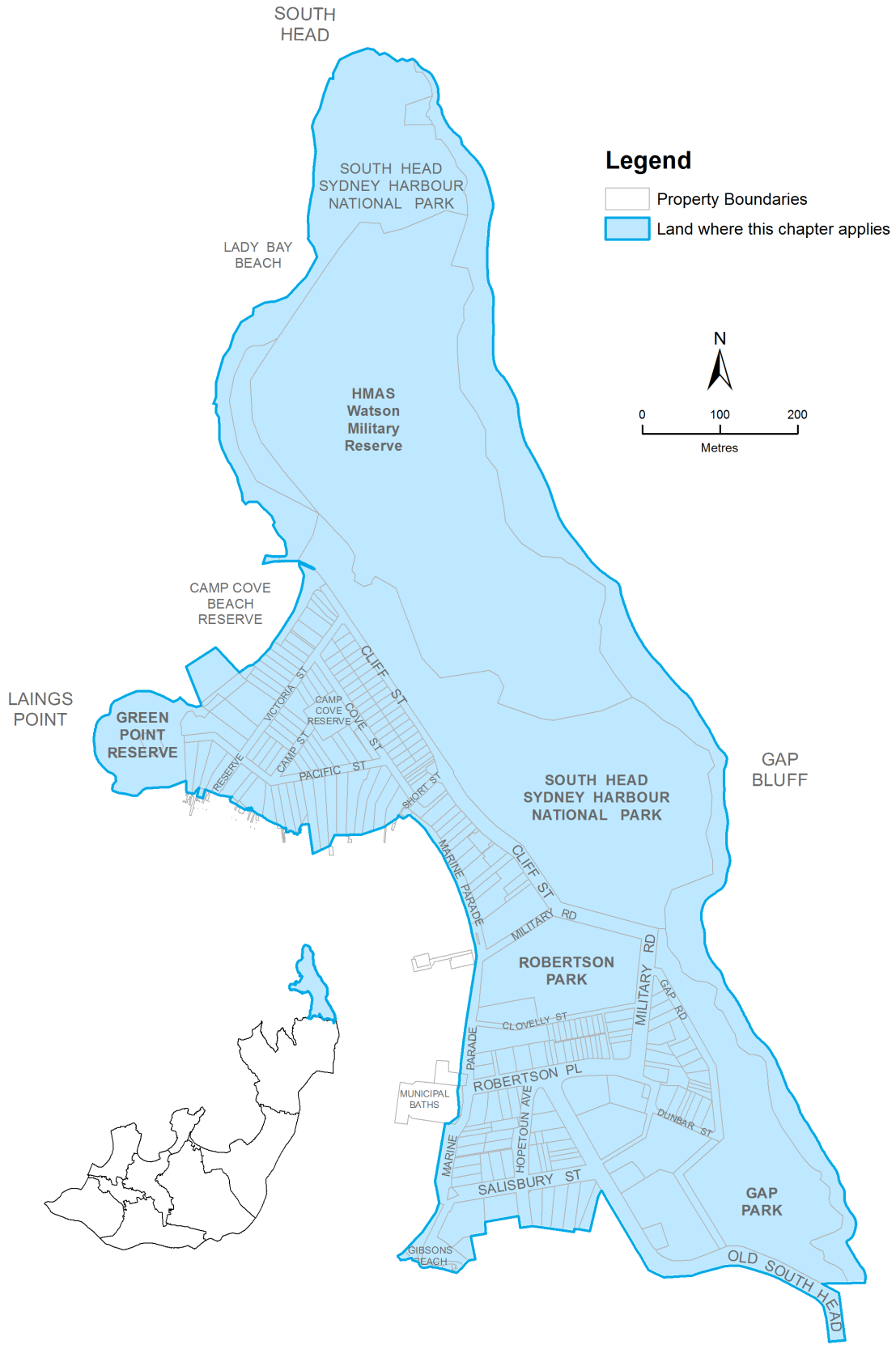
---

This chapter applies to development that requires consent under Woollahra LEP 2014.

Note: Parts of Watsons Bay are under the control of State or Commonwealth authorities and development within these precincts does not require consent from Council. For those precincts, this chapter provides a set of guidelines for those authorities to consider when preparing any plans of management or undertaking development in the precinct.



MAP 1 Watsons Bay HCA chapter boundary



---

### C3.1.4 Objectives

The objectives of this chapter are:

- 01 To facilitate the implementation of the objectives and provisions relating to heritage conservation in Woollahra LEP 2014.
- 02 To acknowledge and conserve the unique built and natural heritage significance of Watsons Bay including places of importance for Aboriginal people.
- 03 To require the retention and appropriate development of heritage items and contributory items.
- 04 To ensure that proposed development is compatible with the significance of the Watsons Bay HCA and the character of its individual precincts.
- 05 To provide controls that encourage contemporary design which responds appropriately to the character of Watsons Bay and the identified heritage values of the area.
- 06 To encourage and promote public awareness, appreciation, understanding and knowledge of heritage conservation.
- 07 To enhance amenity and heritage values within Watsons Bay.

---

### C3.1.5 Relationship to other parts of the DCP

This chapter is to be read in conjunction with the other parts of the DCP that are relevant to the development proposal, including:

- Part B: Chapter B3 General Development Controls - but only if the proposal is for a dual occupancy development (refer to Section B3.8 Additional controls for development other than dwelling houses).
- Part E: General Controls for All Development - this part contains chapters on Parking and Access, Stormwater and Flood Risk Management, Tree Management, Contaminated Land, Waste Management, Sustainability, Signage and Adaptable Housing.
- Part F: Land Use Specific Controls - this part contains chapters on Child Care Centres, Educational Establishments, Licensed Premises and Telecommunications.

---

### C3.1.6 Definitions

The definitions below define words and expressions for the purpose of this chapter.

These definitions apply in addition to the definitions in Part A Chapter A3 of the DCP, the EP&&Act and Woollahra LEP 2014.

<b>missing elements</b>	based on known evidence, including where the missing elements exist to related properties rather than speculation).
-------------------------	---

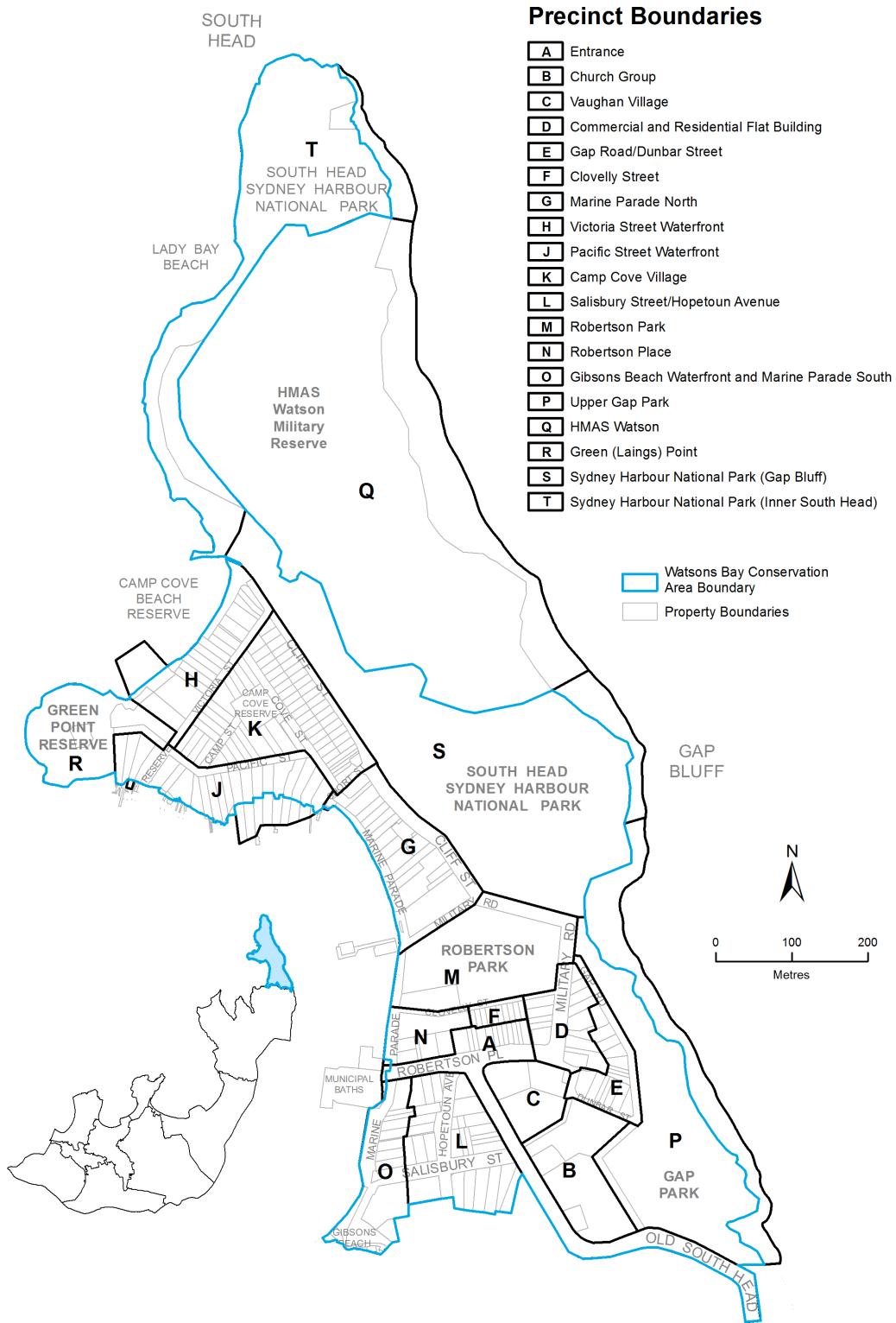
### C3.1.7 How to use this chapter

The provisions of this chapter are to be used by applicants in the sequence set out below.

**TABLE 1** How to use this chapter

Steps to be considered for all development	
<b>Step 1</b>	<p><b>Understanding the context</b></p> <ul style="list-style-type: none"> <li>▶ Read Section C3.2 including the statement of significance for the Watsons Bay HCA and the key heritage values.</li> <li>▶ Identify the precinct where the subject site is located (refer to Map 2). Read the precinct character statement in Section C3.4.</li> </ul>
<b>Step 2</b>	<p><b>Understanding your site</b></p> <ul style="list-style-type: none"> <li>▶ Identify whether the building or site is a heritage item as identified in Woollahra LEP 2014.</li> <li>▶ Identify whether the building or site is a contributory item (refer to Map 3).</li> <li>▶ Consider the history and relationship of the subject site and surrounding sites, having particular regard to heritage items and contributory items in the street.</li> </ul>
<b>Step 3</b>	<p><b>Addressing the objectives and controls</b></p> <p><b>For development that requires consent</b>—each section must be read and the relevant objectives and controls applied:</p> <ul style="list-style-type: none"> <li>▶ Section C3.3 Objectives for development: These objectives apply to the precinct controls and the general development controls.</li> <li>▶ Section C3.4 Precincts: This section contains a character statement and controls for each precinct.</li> <li>▶ Section C3.5 General controls for all development: General controls apply to all development.</li> <li>▶ Section C3.6 Contributory items: Additional built form controls (if the subject site is a heritage item or a contributory item).</li> <li>▶ Section C3.7 Public domain: Applies to land owned and/or managed by Council or other public authorities.</li> </ul> <p><b>For development on public land that does not require consent</b>—each of the above sections should be read, and the relevant objectives and precinct guidelines used to inform development to ensure appropriate conservation and management of the heritage values in the precinct.</p>

MAP 2 Watsons Bay precinct boundaries





## C3.2 Understanding the context

### C3.2.1 Historic context

The natural landscape of Watsons Bay has been dominated by the sea and harbour, influencing its occupation by the original landowners, the Birrabirragal People, and later European settlers. Watsons Bay was the site of the first landing within Sydney Harbour. Permanently occupied from 1790, it is one of the earliest European settlements in Australia. Its rich maritime history is evident in a variety of built and landscape elements that reflect its role in navigation, defence and recreation.

#### Maritime village

While a number of early land grants were made from 1793, the area was unsuitable for farming. As the area's primary use was for a variety of maritime related activities, the signal and pilot stations, and later the lighthouse, were established. To supplement the meagre diet of the colonists, the first fishery in the colony was opened in 1792. The popularity of the area increased upon the completion of South Head Road in the 1830s. The 'Town of Watsons Bay' subdivision of 1855 resulted in the existing layout of Watsons Bay Village including Marine Parade and Cliff, Cove, Camp, Pacific, Victoria and Short Streets.

The mix of early landowners, including fisherman, pilots, master mariners and merchants, is reflected in the variety of housing types in the area. These range from fishermen's cottages to large marine villas, the latter including, *Clovelly* (owned by Thomas Watson and later Sir John Robertson) and *Zandvliet* (known today as Dunbar House).

Further development continued throughout the 19th century, including a range of community buildings such as churches and schools. A further wave of construction occurred during the Inter-War period, including more substantial flats, tourist accommodation and commercial development.

#### Navigation

Watsons Bay has played a key navigational role in guiding ships into the harbour since the early days of the colony. The arrival of a ship was a significant event, being announced by a signal station constructed in 1790 at South Head.

Watsons Bay has been associated with the piloting of ships into the harbour since 1792 when the first pilot station in Australia was established. One of the early pilots was Robert Watson, a former seaman on the First Fleet flagship *HMS Sirius*, after whom the area is named.

A beacon, the first navigational light in Australia, was later installed to guide ships into the harbour. This was later replaced by a number of lighthouses including the existing Hornby Light, erected at Inner South Head in 1857-1858. Another prominent early navigational aid is the stone obelisk at the water's edge at Green (Laings) Point, built in the 1850s to mark the eastern channel into the Harbour.

---

## Defence

Watsons Bay has also played a role in the defence of Sydney. The fear of attack by Russian warships during the Crimean War resulted in construction of a number of artillery batteries, beginning in 1853. These were completed between 1871 and 1876 under the supervision of Colonial Architect James Barnet.

Improved and extended over 90 years, the fortifications at South Head became obsolete by the 1960s and were largely removed. Many of the former gun emplacements continue to be a feature of the area. Associated with these batteries was accommodation for the NSW Artillery and subsequent units stationed at South Head, including the artillery school from 1895.

The Navy's occupation began during World War II, with the upgrading of the South Head facilities to include a radar station. HMAS Watson was commissioned in 1945, expanding its operations in the 1950s to include the Radar Training School and the RAN Principal Warfare Training Centre in the 1960s. Today, it is a key feature of the South Head landscape.

The Russian naturalist and explorer, Baron Nikolai Nikolaevich Miklouho-Maclay, established a Biological Research Station on Green (Laings) Point in 1881 and by 1888 an underwater mine control facility had been built nearby. The military acquired the Biological Station, building and land, for their own use in around 1899. An anti-torpedo and midget submarine boom net stretching across Sydney Harbour was also constructed at Green (Laings) Point during World War II, evidence of which can be seen in the remnants of the base of a Winch House.

Camp Cove featured one of three water police stations established in Sydney Harbour by 1840. This was occupied irregularly up to the 1870s when it was absorbed into the artillery base.

## Recreation

The location of Watsons Bay, on the harbour close to South Head, ensured its popularity not only with local residents, but also as a tourist destination dating from as early as 1803. Subdivision in the 1850s attracted the attention of land speculators who promoted Watsons Bay as an excursion destination for day-trippers and holidaymakers. This image was enhanced with the provision of a ferry service in the 1850s and tram service in 1903.

The growing tourist trade encouraged the building of a number of tea rooms, cafes and hotels by the mid-1860s. Further promotion by the local council included boats for hire, public baths and the creation of a number of public parks and reserves which continue to exist today.

Influential writers such as Christina Stead and Zane Grey (c1930s) chronicled the great scenic beauty of the maritime village as well as the area's history of tragic shipwrecks and suicides. Today, Watsons Bay continues to be a local tourism and recreational venue as well as a desirable place to live.

### C3.2.2 General character description

Watsons Bay is dominated by a rugged coastal landscape that defines the east side of a narrow peninsula at the entrance to Sydney Harbour. Its natural topography includes exposed ridges and cliff faces to the Tasman Sea, which contrast with the protected bays and sheltered beaches on Sydney Harbour.

A subdivision and development pattern has evolved since settlement on the gently sloping western side of the peninsula. The pattern is clearly influenced by the landform, topography and drainage patterns.

The built form retains the character of a low-scaled early 19th and 20th century maritime village, enhanced by natural vegetation and parklands, including the continuous park along the ridge line and cliff tops.

The area offers important views and vistas to the heads, Sydney Harbour, the Sydney CBD and the Tasman Sea. Landmarks within the area, such as church spires and the lighthouse, can be viewed from the Sydney CBD Maritime linkages are visually reinforced by the many maritime structures including wharves, jetties, boat sheds and promenades that remain.

Watsons Bay from the harbour



Green (Laings) Point



Hornby Lighthouse and sandstone cliffs at South Head



Gun emplacement looking over Camp Cove



Dunbar House and Robertson Place with Robertson Park





### C3.2.3 Statement of significance

---

Watsons Bay is a place of great natural and scenic beauty. It is a rare combination of a dramatic and varied coastal landscape and a village that evolved from the first landing point in Sydney Harbour in 1788, the third permanent settlement in New South Wales from 1790 and a pilot station established in 1792.

It conveys a strong sense of its maritime heritage in its built and landscape features that evidence four key historic themes:

- ▶ **The growth of a village:** Evident in the subdivision and development pattern that occurred during the 19th century and continued throughout a number of phases. These phases are demonstrated in the range of building types still present in the area, from moderately scaled fisherman's cottages, more substantial houses and marine villas to Inter-war period housing and community buildings.
- ▶ **Navigation:** Evidenced by the key role South Head has played in piloting ships into Sydney. A number of navigation structures, such as the lighthouse, wharves and jetties, have important historic and aesthetic significance.
- ▶ **The defence of Sydney at The Heads:** Reflected in the 19th century South Head batteries and artillery establishment, complex of fortifications, HMAS Watson and the extent of the untouched landscape typical of defence occupation of the foreshores.
- ▶ **Recreation and tourism:** Dating from as early as 1803, there has been a strong emphasis on water related tourism facilities, such as hotels, beach promenades and parks. Tourism was further enhanced as a result of the area's association with shipwrecks and by association with important cultural figures such as Christina Stead and Zane Grey. The extensive and varied landscape and village character also contributes to the appeal of Watsons Bay to tourists.

Hornby Lighthouse (1857–1858)  
above the cliffs of South Head



Timber weatherboard cottages in Cliff Street



### C3.2.4 Key heritage values

#### Historic (evolution)

- ▶ A true Gateway to Sydney: reflected in the area’s modest start as a fishing village and maritime heritage.
- ▶ Role in navigation: pilot station, lighthouses, wharf, jetties and navigational markers.
- ▶ Role in defence: HMAS Watson, coastal defence structures and relics, Water Police, Constable’s Cottage, gun emplacements, underwater mine control tunnels and winch house for anti-torpedo and midget submarine boom net at Green (Laings) Point.
- ▶ Evidence of early fishing village and more substantial houses built for master mariners, pilots, lighthouse keepers and city merchants. A later wave of Inter-War housing and associated public buildings and community infrastructure (development/subdivision).
- ▶ Importance as a historical tourist destination and recreation venue: ferry wharf, hotels, tea room, waterfront promenade, cliff walk, parks, The Gap, yacht club and game fishing club.
- ▶ Strong sense of history represented in historic road alignments, built character and monuments such as South Head Road obelisk, Governor Phillip Memorial
- ▶ Site of an early, if not the first, marine biological research station in Australia which reflects the diversity of the aquatic environment.
- ▶ Educational role: Former School of Artillery, Submarine Warfare Systems Centre, former Watsons Bay State School (now scout hall), former site of Catholic Parish School and Convent School.

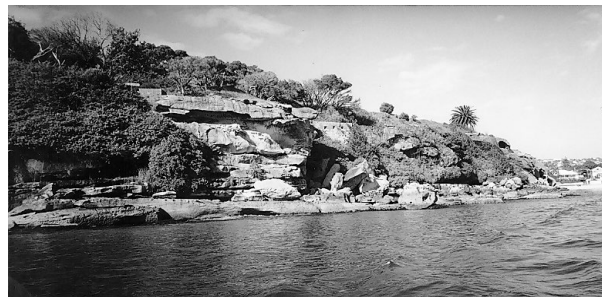
#### Historic (association)

- ▶ Reflected in Watsons Bay place names is the area’s association with maritime figures and events such as Lt William Bradley, Robert Watson, Henry Gibson and historic shipwreck, Dunbar.
- ▶ The area has been the inspiration for books and other literature and is associated with authors Christina Stead and Zane Grey.
- ▶ Watsons Bay is associated with leading figures in Sydney’s history. Examples include ‘Clovelly’ residents Hannibal Macarthur and Sir John Robertson, merchant pilot and lighthouse keeper Richard Siddons and Colonial Architect Mortimer Lewis

More substantial housing in Victoria Street, Camp Cove



Sydney Harbour National Park (Inner South Head)



Camp Cove Beach



Views across the harbour



### Aesthetic

- ▶ Scenic beauty.
- ▶ Dramatic and varied landscape:
  - topography, exposed cliffs, protected bays;
  - sheltered beaches, tranquil ambience; and
  - pedestrian quality/amenity.
- ▶ Low-scale built form, subservient to landscape.
- ▶ Collection of small-scale cottages, including important weatherboard groupings.
- ▶ Views and vistas (see Map 4 in Section 3.3.4):
  - from elevated landform and parks;
  - across Robertson Park from promenade;
  - in from harbour;
  - water glimpses from streets; and
  - glimpses of landmarks/churches/significant trees.
- ▶ Number of landmark buildings, including Dunbar House and the St Peters Church.
- ▶ Backdrop of vegetation that dominates buildings. Rock shelves and beaches.
- ▶ Natural edges, including coastal vegetation in Sydney Harbour National Park, juxtaposed with built edges.
- ▶ Cultural plantings such as the Moreton Bay figs in Robertson Park as well as the coral trees in Cliff Street.

### North end of Marine Parade



### Social

- Scenic beauty and low-scale village character valued by the local community and visitors.
- Importance to Sydneysiders as a tourism and recreational destination.
- Attention as a place where Sydney residents bring visitors from interstate and overseas to enjoy its character, ambience and sense of history.
- Availability as a place to view Sydney Harbour, the Tasman Sea and the coast as well as enjoy maritime events such as yacht races, fireworks and arriving ships).
- Maritime sports clubs, including Vaucluse Yacht Club and Sydney Game Fishing Club.
- Gathering place for families and friends. Venues such as the Naval Chapel, St Peters, Star of the Sea, The Gap Bluff Centre and Dunbar House are within walking distance between venues (Naval Chapel, St Peters, Star of the Sea, The Gap Bluff Centre, Dunbar House).

### Scientific (ability to yield information)

- Role in defence: anti-torpedo and midget submarine boom net at Green (Laings) Point.
- Marine life: biological research, sea grasses.
- Potential to contain archaeological evidence of its early development.
- Gap Bluff, site of early radar development by navy.

### Cliff Street with Sydney Harbour National Park at left



### Recreational boating



Former Marine Biological Research Station at Green (Laings) Point



Archaeological remains at Green (Laings) Point



### C3.2.5 Management policy

Having regard for the heritage significance of the Watsons Bay HCA, Council has adopted the following policy for the management of the area.

These objectives and management processes apply to when undertaking work in the public domain and when assessing development applications.

#### Objectives

- 01 To conserve the heritage significance of the Watsons Bay HCA.
- 02 To conserve heritage items and contributory items (i.e. those properties, landscape elements and other features identified as contributing to the significance of the Watsons Bay HCA), including significant fabric, curtilages and settings.
- 03 To retain the key heritage values of the Watsons Bay HCA, including its natural and cultural scenic beauty the built and landscape evidence of its historical development, the low-scaled village character, views and vistas to landmarks and water, the backdrop of vegetation, the predominance of landscape over buildings, sheltered beaches and tranquil ambience.
- 04 To encourage the reconstruction of heritage items and contributory items that have been unsympathetically altered, including reinstatement of missing elements.
- 05 To allow for removal and/or alteration of uncharacteristic features that detract from the significance of the Watsons Bay HCA.
- 06 To ensure that proposed development is compatible with the significance and character of the Watsons Bay HCA.

Note: The term 'original' as used throughout the DCP refers to any significant fabric. This may be from a range of historic periods.

### Management processes

Council will implement the following processes in managing the Watsons Bay HCA:

- ▶ Council will continue to develop policies and controls aimed at conserving and managing the heritage significance of Watsons Bay, including the heritage and contributory items within it.
- ▶ In recognition of the heritage significance of the Watsons Bay HCA, its precincts, heritage items and contributory items, applications for development will be assessed with regard to the impact of the proposed development on individual properties, key heritage values and the overall significance of the Watsons Bay HCA.
- ▶ Development shall be assessed having regard to the principles contained in the Australia ICOMOS *Charter for the Conservation of Places of Cultural Significance* (the *Burra Charter*).
- ▶ Council will require the preparation of a heritage impact statement or, in some cases, a conservation management plan, to accompany development applications for major works. This includes the demolition, partial demolition, major alterations and additions, or new or replacement development.
- ▶ Applications for demolition of a building in the Watsons Bay HCA should only be considered in conjunction with a development application for proposed replacement development.

---

### C3.3 Objectives for development

The unique character of Watsons Bay lies in its overall natural landform and its historic built forms. Its broad spectacular views of the harbour, its dramatic cliff lines and the streets and public promenades all provide a framework for the public experience of Watsons Bay.

The section contains objectives for development that apply to the following matters:

- ▶ topography and vegetation
- ▶ townscape;
- ▶ the waterfront;
- ▶ views and vistas
- ▶ built form - building footprint, building siting and alignment, building height, building form;
- ▶ building character, building materials and details;
- ▶ landscaping and private open space;
- ▶ fences and walls;
- ▶ car parking and access;
- ▶ site facilities and aerial devices; and
- ▶ acoustic and visual privacy.

These objectives for development apply to:

- ▶ the precinct controls in Section C3.4 of this chapter; and
- ▶ the general controls for development in Section C3.5 of this chapter.

Development is to be designed and sited according to the precinct and general controls. If compliance cannot be achieved with the controls, development must demonstrate that it meets the objectives in this section.

### C3.3.1 Topography and vegetation

Watsons Bay is dominated by a rugged coastal landscape. Its natural topography includes exposed heath-covered ridges and sheer sandstone cliff faces to the Tasman Sea and harbour mouth, which contrasts with the protected bays and sheltered beaches within Sydney Harbour.

The area retains an extensive backdrop of natural vegetation as well as significant cultural plantings and historic parklands. The extensive and varied landscape also contributes to the attraction of Watsons Bay for tourists.

#### Objectives

- 01 To ensure that the landforms of Watsons Bay remain a dominant feature of the landscape.
- 02 To ensure that new development respects the existing topography of the conservation area.
- 03 To ensure that significant natural and cultural plantings are retained, in both the public and private domains.
- 04 To ensure that new development retains significant cultural plantings, minimises the impact on existing vegetation and respects the character of the landscape.
- 05 To retain the prominence of the vegetated landscape and the prominence of the treed skyline.

Sandstone cliff faces, South Head



Extensive and varied landscape



Backdrop of vegetation



Significant natural and cultural plantings within Watsons Bay





### C3.3.2 Townscape

The subdivision and development pattern of Watsons Bay has evolved since settlement on the gently sloping western side of the peninsula. The pattern is clearly influenced by the topography and drainage patterns. The built form retains the character of a low-scaled early 19th and 20th century village, enhanced by natural vegetation and parklands, including the continuous park along the ridgeline and cliff tops.

The townscape of Watsons Bay primarily retains a village character with harbour views and glimpses and a backdrop of extensive areas of vegetation along exposed ridgelines. Distinct precincts are evident throughout the area and individual streetscapes are varied in terms of architectural style, visual elements and the use of individual sites.

#### Objectives

- 01 To ensure that historic development patterns are retained and conserved.
- 02 To ensure that any block subdivision and new development reflects historic development patterns and the character and village scale of Watsons Bay.
- 03 To ensure that the character of each precinct and streetscape is retained.
- 04 To ensure that new development creates opportunities for the vegetation backdrop along ridgelines to be enhanced.
- 05 To ensure that significant views over the township are retained, particularly in terms of the visual character of roofscapes.

Camp Cove Beach



Marine Parade North promenade



Rock shelves and jetties along Pacific Street waterfront



Rock shelves at Green (Laings) Point



### C3.3.3 The waterfront

Watsons Bay has been a recreation and tourist destination from as early as 1803, with the location of hotels, promenades and parks giving strong emphasis on water related activities such as swimming and boating. Many private properties also have water frontage, access and/or visual links to the harbour foreshore.

Strong visual maritime linkages are reinforced by the many maritime structures including wharves, jetties, boatsheds, swimming baths and promenades that remain along the waterfront, as well as a yacht club. The promenades characterise the publicly accessible foreshore area that forms the interface between the harbour and private land. The following objectives and controls apply to the waterfront, inclusive of the intertidal zone.

#### Objectives

- 01 To ensure that publicly owned foreshore areas are retained within the public domain and are not privatised.
- 02 To ensure that opportunities are created for continuous links along the foreshore via open space and publicly accessible areas.
- 03 To conserve maritime structures that contribute to the heritage significance of the area.
- 04 To ensure significant views and vistas to and from the waterfront are retained.
- 05 To protect the scenic quality of the natural landscape and built environment when viewed from Sydney Harbour.
- 06 To conserve the natural land and water interface.
- 07 To reinforce the natural character of the foreshore.
- 08 To protect environmentally sensitive marine environments and habitats.

Existing views across the harbour towards the city from Victoria Wharf Reserve



Existing view to the harbour



---

### C3.3.4 Views and vistas

---

Watsons Bay contains important views and vistas. These are identified in Map 4 below.

Of particular note are the views to and from the harbour, views over Watsons Bay from the higher locations within the area and the views between buildings, through parklands and along streetscapes.

The area is characterised by a series of significant visual gateways, due mainly to its topography and dramatic landscape.

Visual gateways include the sweeping view of the entire area from Belah Avenue on the bend along Old South Head Road, high above Watsons Bay and the views from Gap Park. Views into and out of Robertson Park, which form a visual gateway and distinctive public area between the northern and southern ends of the conservation area, are also significant.

#### Objectives

- 01 To ensure that identified significant public views and vistas are retained.
- 02 To ensure that new development does not block identified significant views and vistas.
- 03 To create opportunities for new views and vistas within the public domain.
- 04 Where possible, to reinstate views and vistas that are currently blocked.
- 05 To ensure that distinctive visual gateways within the conservation area are retained.
- 06 To encourage view sharing as a means of ensuring equitable access to views from dwellings.



---

### C3.3.5 Built form

---

These objectives apply to new buildings (infill development) as well as alterations and additions to existing buildings, including contributory items.

#### New buildings

It is important that new buildings respect the character of Watsons Bay. Generally, where an area has character that is valued, new buildings are required to conform with infill criteria. Good infill is demonstrated when new structures enhance and complement the existing urban character.

Contemporary design provides the basis for the continuing enrichment of the historic interpretation of Watsons Bay HCA. Issues of contemporary design are relevant to new development of a minor and major nature in both the public and private domains.

Council does not advocate replication of previous architectural styles in cases of infill development. Where infill development is proposed, a contemporary design approach which respects the context is encouraged. The use of contemporary design approaches must be able to achieve a cohesive relationship between new and existing urban fabric.

Applicants are required to demonstrate how their application of contemporary design techniques and materials responds appropriately to the physical and historical context of the site. In some instances, a conservation management plan may be required as the preliminary step in the contemporary design process.

The use of contemporary design approaches must achieve a cohesive relationship between new and existing urban fabric.

The controls for new buildings in Section C3.4 and C3.5 (i.e. infill development) are based on the standard infill criteria that apply in conservation areas throughout New South Wales. Reference should be made to the publication titled *Infill – Guidelines for the Design of Infill Buildings* published by the Heritage Council of NSW and the Royal Australian Institute of Architects (NSW Chapter).

#### Alterations and additions to existing buildings

Alterations and additions to contributory items must not adversely affect their heritage value and contribution to the heritage character of the area. Alterations and additions must be carefully designed to ensure that the original character elements and contributory features of a building area retained. Additional objectives and controls also apply to alterations and additions of contributory items (refer to Section C3.6).

There is greater scope for alterations and additions to non-contributory items, provided the proposed work does not detract from the scale or character of the streetscape or conservation area generally. Where the addition is not visible from the street, waterfront and public places, its form becomes less important and there is a greater flexibility in design. For example, a contemporary design may be appropriate for an addition at the rear of an existing house.

## Objectives

- 01 To ensure that development respects the character of, and minimises visual impact upon, the area and its individual precincts and streetscapes through appropriate design and siting.
- 02 To ensure that development is designed and located in such a way that it retains and enhance the heritage values of the Watsons Bay HCA as identified in Section 3.2.4 of this chapter.
- 03 To ensure that development respects the scale, character and setting of any contributory items in its vicinity.

### 3.3.5.1 *Building footprint*

Building footprints limit the area of development on a site to allow enough room for landscaped garden and open space areas, conforming to the low scale residential village character of Watsons Bay. Limiting impervious surfaces also assists in stormwater infiltration which reduces overland stormwater flows during times of heavy rain.

- 01 To retain the low density residential character of Watsons Bay.
- 02 To limit the extent of built upon area on a site so that there is adequate area for open space, landscaped area, vegetation plantings and stormwater infiltration.
- 03 To facilitate landscaped garden areas throughout Watsons Bay.

### 3.3.5.2 *Building siting and alignment*

The siting and alignment of buildings are important elements of the streetscapes of Watsons Bay. Within the majority of streetscapes, there is an overall consistent pattern of development with similar setbacks from front and side boundaries.

## Objectives

- 01 To ensure that development conforms to the predominant setbacks from front and side boundaries within the vicinity of the site.
- 02 To ensure that development is sympathetic to the streetscape in terms of alignments, setbacks and orientation.
- 03 To ensure that the siting and floor levels of buildings are similar to the levels and siting of contributory items within the streetscape.
- 04 To ensure that the location of development allows for view sharing and preserves the privacy and reasonable sunlight access of neighbouring properties.
- 05 To encourage retention, or creation, of useable open space at the rear of sites.

### *Excavation*

- 06 To allow buildings to be designed and sited to relate to the topography with minimal cut and fill.
- 07 To minimise excessive excavation.
- 08 To limit damage to Council infrastructure, such as roads, from truck movements.
- 09 To restrict energy expenditure associated with excavation and traffic emissions from truck movements.
- 010 To ensure the cumulative impacts of excavation does not adversely impact land stabilisation, ground water flows and vegetation.
- 011 To minimise structural risks to adjoining structures.
- 012 To minimise noise, vibration, dust and other amenity impacts to adjoining and adjacent properties.

### **3.3.5.3 Building height**

Building heights throughout Watsons Bay are generally consistent. This is an important unifying element that contributes to the character of the area and individual precincts.

While individual building heights in Watsons Bay vary, there is a predominance of single storey dwellings and cottages with a smaller number of two storey terraces and new buildings. It is important that new buildings and additions are designed to respect the scale of contributory items, particularly those adjacent, in order to retain the character of the precinct in which it is located and the area generally.

### **Objectives**

- 01 To ensure that development does not visually dominate the streetscape.
- 02 To maintain existing visual consistency of streetscapes.
- 03 To ensure that development does not visually dominate contributory items.
- 04 To minimise the impact of development on views from neighbouring sites and public places.

### **3.3.5.4 Building form**

Form is the three dimensional volume or massing of a building. The form or 'massing' of buildings in the Watsons Bay HCA is relatively consistent. Most buildings have a hipped or gabled roof of 30° pitch (slope) or greater. The buildings are characterised by simple forms. It is important that new buildings are designed to respect these traditional forms in order to retain the character of the area.

---

### Objectives

- 01 To retain the identified village character of the area.
- 02 To maintain visual consistency of building forms to ensure that new buildings do not dominate.
- 03 To retain the character of the roofscape of Watsons Bay, particularly when viewed from the harbour.

#### **3.3.5.5 Building character**

Watsons Bay retains a significant built form that has the character of a low-scaled 19th and 20th century village. A variety of building forms and styles exist throughout the area. Distinct precincts are evident throughout the area and individual streetscapes are varied in terms of architectural style and character.

### Objectives

- 01 To ensure that the character of development enhances the streetscape by remaining in harmony with adjacent contributory items and minimising the visual impact upon the immediate area.
- 02 To ensure that the design of development responds to the character and style of adjacent and surrounding contributory items.
- 03 To promote sympathetic contemporary design that responds to the historic character of the area.

#### **3.3.5.6 Building materials and details**

Original materials, details and decorative elements have heritage significance and contribute greatly to the style and character of individual building and the Watsons Bay HCA overall. Modern materials and details may be appropriate if their proportions are similar to those of original elements. Colour and tonal contrast can be used as unifying elements to ensure an appropriate response to the historic context.

### Objectives

- 01 To ensure that development responds to the character of existing development and the significance of the area.



---

### C3.3.6 Landscaping and private open space

---

Private open space contributes to the amenity of individual dwellings. The Watsons Bay HCA is characterised by smaller allotments with landscaped areas to both front and rear of existing buildings. Landscape treatment helps to determine the amenity of individual dwellings, define private and public areas, reinforce views, provide screening and define streetscape character. Existing trees and vegetation may support significant indigenous wildlife populations and habitat. Areas of landscaping can also play an important role in stormwater management.

Roof terraces are not characteristic of Watsons Bay and are not generally acceptable as private or communal open space. Further, because of the dense built character and sloping landform, use of roof terraces can produce detrimental impacts on privacy due to overlooking and noise transmission.

#### Objectives

- 01 To promote landscaping that contributes to the character of the conservation area.
- 02 To ensure that adequate provision is made for accessible and usable private open space.
- 03 To retain significant mature trees, vegetation and other landscape features.
- 04 To enhance the appearance, amenity and energy efficiency of housing through integrated landscape design.
- 05 To ensure that the design and use of private open space areas do not adversely impact the amenity of adjoining properties.
- 06 To ensure that trees and other vegetation do not adversely impact the fabric of buildings and works.
- 07 To provide landscaping that assists with stormwater management.

---

### C3.3.7 Fences and walls

---

Fences and walls play a major role in forming the character of a house. Carefully designed fences and walls help to integrate developments into the streetscape. Each architectural period or building type had an associated style of fence, so the materials and design of front fencing varied. Victorian and Federation period houses generally had a timber picket fence or wire on timber rails. Sometimes, these also had a low brick or sandstone base.

#### Objectives

- 01 To retain original fences and gates.
- 02 To reinstate fences and gates on street frontages and side streets in a style appropriate to existing buildings.
- 03 To maintain traditional heights of fences and their elements.
- 04 To encourage on infill structures fences and gates that reinterpret, in a contemporary manner, the details of traditional fences.
- 05 To ensure fences and walls contribute positively to the streetscape and adjacent buildings while improving amenity for residents.
- 06 To ensure boundary fences between allotments provide visual privacy without affecting the amenity of either allotment in terms of views, sunlight and air movement.
- 07 To ensure materials used in fences and walls are of a high quality and in keeping with the character of the existing dwelling and the streetscape.
- 08 To ensure fences and walls are sympathetic to topography.
- 09 To ensure front fences to corner sites maintain adequate visibility for vehicles and pedestrians.

---

### C3.3.8 Car parking and access

---

Garages, carports and on-site parking areas for vehicles were not elements incorporated into earlier forms of housing. Garages only emerged as a building type with the advent of the motor car just prior to World War I. Over time, two car families and the desire for vehicle security have created pressure for large garages and car spaces within sites. These can have an adverse impact on the streetscape. Often, they also result in a reduction of tree, landscaped area and usable open space within properties and increased removal of sandstone kerbing for driveway crossovers.

The design of parking and driveway areas should also acknowledge the need to limit the amount of impervious surfaces over a site and the amount of site excavation to reduce heat storage and stormwater runoff.

#### Objectives

- 01 To ensure that the massing form and scale of new garages and carports are sympathetic to the streetscape, historic context and setting of existing buildings.
- 02 To ensure that on-site car parking and driveways do not dominate or detract from the appearance of existing buildings, new development and the local streetscape.
- 03 To encourage development that is scaled for the pedestrian in terms of height, articulation and modulation.
- 04 To provide a balance between vehicle parking within sites, landscaped area and usable open space.
- 05 To conserve original elements and structures on street frontages and property boundaries.
- 06 To retain original sandstone kerbing.
- 07 To improve streetscape character where earlier unsympathetic development has eroded urban spaces.
- 08 To minimise vehicle and pedestrian conflicts.
- 09 To minimise problems with traffic movement and circulation.
- 010 To limit adverse stormwater runoff and temperature impacts of impervious surfaces.

---

### C3.3.9 Site facilities and aerial devices

---

The roofscape of Watsons Bay is an integral component of its overall significance.

The introduction of unsympathetic and uncharacteristic site facilities such as lift overruns, air-conditioning, mechanical ventilation, telecommunication facilities, satellite dishes, solar heating devices and aerals can have a detrimental impact on the aesthetic significance of individual buildings and on the conservation area generally.

The fixing of these structures on roofs and chimneys can also contribute to physical damage and possible loss of original fabric and detail.

To protect visual amenity, consideration must be given to the location, size and design of site facilities including fire safety systems and mechanical plant equipment such as lift overruns, air-conditioning units and condensers, heating, ventilation and other mechanical systems that maintain or support the operations of a building.

The location and design of other site facilities such as mail boxes, garbage storage areas, external storage facilities, clothes drying areas and laundry facilities can also have a detrimental impact upon the appearance and overall character of the area and must be carefully considered.

#### Objectives

- O1 To retain the character of the significant roofscapes of the Watsons Bay HCA, particularly when viewed from elevated locations.
- O2 To ensure that site facilities are unobtrusive and do not adversely affect original fabric and details of roofs and chimneys.
- O3 To ensure that site facilities are unobtrusive and their design and location do not adversely affect the character of individual buildings and the streetscapes.
- O4 To ensure that roofs are not cluttered by intrusive site facilities.
- O5 To minimise visual and acoustic impacts on adjoining properties.

#### Controls

- C1 Air conditioning units, condensers and other mechanical plant equipment in infill development or substantial additions must be located internally within the building.
- C2 Mechanical plant equipment is wholly contained within the permissible building envelope and must not be located externally or on the roof unless Council is satisfied that it:
  - a) Cannot be reasonably located elsewhere; and
  - b) Is thoughtfully located, sized, enclosed, concealed and integrated into the building design (including when viewed from above) and roof form so it:
    - i. Is not visible from the streetscape or public domain;
    - ii. Is consistent with the overall building form and materials;
    - iii. Is visually discreet and unobtrusive when viewed from adjoining properties; and
    - iv. Minimises acoustic impacts to adjoining properties.

- 
- C3 Screening will only be considered where the screening is suitably located, integrated with the building design and materials and will have no impact on views or result in overshadowing of adjoining properties.

Note: Screening alone may not be an acceptable solution for ensuring that mechanical plant equipment is not visible from the streetscape or the public domain.

- C4 Hydraulic fire services such as fire hydrants and booster installations must be concealed. These services are to be:

- a) enclosed with doors if located in the building façade, or
- b) housed in a cabinet or enclosure if located external to the building.

The location, design, colour and material of the doors, cabinet or enclosure must be visually unobtrusive and suitably integrated with the development, including fencing and landscaping.

- C5 An electricity substation is to be suitably located, screened and/or concealed so it is not visible from the street, or any other adjoining public place. Council's preference is for a chamber substation. Any screening or enclosure to conceal the substation is to be visually unobtrusive and suitably integrated with the development, including the fencing and landscape design.

- C6 The electricity substation is located away from neighbouring properties or sufficiently screened from neighbouring properties.

- C7 The location and design of the electricity substation must be considered and integrated with the landscaping of the proposed development, and must ensure that:

- a) Vegetation does not overhang or encroach within the substation site.
- b) The substation is installed outside of the mature growth root zone of any trees to be retained, or proposed to be planted, to prevent roots damage to underground cables.

- C8 The design and location of all other aboveground utility infrastructure (such as electrical pillars etc.) should minimise visual clutter within the streetscape and provide for a continuous accessible path of travel, where practical to ensure safe and equitable pedestrian circulation for people of all abilities. (Where this provision and Ausgrid's requirements cannot both be satisfied, the applicant is to develop in consultation with Council and Ausgrid a solution that meets acceptance of both consent authorities.)

Notes:

- At the DA stage the applicant should demonstrate that they have engaged with Ausgrid and have a network capacity assessment undertaken for the proposed development.
  - Where a substation is required, the substation should be identified on the DA plans and addressed in the *SEPP 65 Design Verification Statement* (also see Apartment Design Guide Objective 3C-2 Amenity of the public domain is retained and enhanced).
  - The DCP requirements for substations apply in addition to the Ausgrid Network Standards, such as *NS113 Site selection and construction design requirements for chamber substations*. Separate Ausgrid approval for the substation will be required.
  - A dedicated access way/easement through the site to the substation will also need to be provided in accordance with the requirements of Ausgrid and Council.
-

---

### C3.3.10 Acoustic and visual privacy

---

Privacy is a major determinant of the ability of residents and neighbours to enjoy their homes. The acoustic and visual privacy needs of residents are to influence all aspects of design, including the location of new building works, building scale, the placement of windows, the location of main living rooms in a building and the type of materials and construction techniques.

#### Objectives

- 01 To ensure an adequate degree of acoustic and visual privacy in building design.
- 02 To minimise the impact of new development on the acoustic and visual privacy of existing development on neighbouring lands.

## C3.4 Precincts

The Watsons Bay HCA comprises 19 distinct precincts. These precincts are shown on Map 2.

These precincts comprise areas that are private land, as well as areas that are public land. Character statements are established for each precinct. The character statements identify elements that are to be retained.

Most precincts contain heritage items and contributory items. The heritage items are identified in Schedule 5 of Woollahra LEP 2014. The contributory items are listed within each precinct and located on Map 3 – Contributory Items.

### Private land

Eleven precincts, and parts of the Gibsons Beach Waterfront and Marine Parade South precinct, apply to private land. The provisions in this section of the DCP respond to the character of each precinct and establish specific controls for development.

The controls address matters such as built form, streetscape presentation and the interface with adjoining precincts. The controls apply to infill development as well as additions and alterations to existing buildings. Applicants need to comply with the controls applying to the precinct where the development is located.

The precinct specific controls supplement the general development controls in Section C3.5. If there is an inconsistency between the precinct controls and the general controls, the precinct controls take precedence.

If compliance with a precinct control cannot be achieved, it must be demonstrated that the objectives for the control can be met (refer to Section C3.3).

### Public land

Seven of the precincts, and parts of the Gibsons Beach Waterfront and Marine Parade South precinct, are under the control of public authorities, including National Parks and Wildlife Service, Sydney Harbour Federation Trust and HMAS Watson. Development within these precincts does not require consent from Council. The relevant public authority is the approval body for these precincts.

For development on public land where consent is not required, this section sets out guidelines for public authorities to consider when preparing any plans of management or undertaking development in the precinct.

### C3.4.1 Precinct A: Entrance

#### Character statement

This precinct stretches from the south end of Upper Gap Park along Old South Head Road to Robertson Place. This area serves as a spectacular gateway to Watsons Bay with a sense of arrival enhanced by elevated views and vistas over Watsons Bay and Upper Gap Park Reserve to the Heads (Figures 1, 2 and 3).

The two storey housing on the north side of Robertson Place terminates the descent into Watsons Bay along Old South Head Road. The historic road alignments of Old South Head Road and Robertson Place have been retained, although the early form of Robertson Place has been altered by the change in levels around a visually intrusive roundabout.

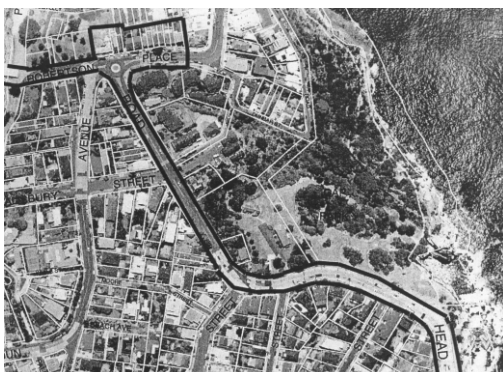
Contrasting built elements within the precinct create a visually diverse streetscape. There is a significant grouping of historic buildings on the north side of Robertson Place, comprising three two storey Federation period semi-detached dwellings, a pair of originally single story Victorian period weatherboard semi-detached dwellings and “Keronga”, a 1920s two storey (plus basement) residential building (Figure 4). The group is relatively consistent in its scale and alignment. Setbacks to each building, although varied, incorporate a set pattern that reflects the road alignment. A contemporary residence, within which remnants of a 1830s stone cottage remain, visually detracts from the group of earlier buildings.

A single detached house at the intersection of Hopetoun Avenue (within the Salisbury Street/Hopetoun Avenue Precinct) and the low-scaled (two storey) retirement housing (within the Vaughan Village Precinct) on the east side of the precinct are both set within gardens behind a low sandstone block wall. This fencing is characteristic of the fencing within this precinct, which consists mainly of sandstone block or rendered brick (Figure 5).

A small sandstone obelisk commemorates the completion of the construction of (Old) South Head Road to Watsons Bay in 1811.

Although partly obscured by the single storey yacht club, significant public views west from Robertson Place to the public baths and Sydney Harbour have been maintained.

**FIGURE 1** Aerial view of the precinct



**FIGURE 2** View over Upper Gap Park and Watsons Bay to the Harbour





**FIGURE 3**

View over Upper Gap Park to the Heads

**FIGURE 4**

Two storey housing on north side of Robertson Place

**FIGURE 5** Old South Head Road featuring low sandstone wall stepping up both sides

## PRECINCT CONTROLS

The precinct specific controls supplement the general controls for development in Section C3.5. If there is an inconsistency between the precinct controls and the general controls, the precinct controls take precedence.

### Topography and vegetation

- C1 Existing scale relationships are to be maintained between more elevated properties along Old South Head Road and the properties lower down along Robertson Place.
- C2 No change in existing building heights is permitted for properties fronting Robertson Place.

### Townscape

- C3 Existing subdivision patterns along Robertson Place are to be retained. Any proposal to create a new lot or amalgamate lots must be of a size (in area and dimensions) which reflects the characteristics of historically relevant lots adjoining and in the vicinity of the site.
- C4 Historic road alignments of Old South Head Road and Robertson Place are to be retained.

### Views and vistas

- C5 Existing views from the public domain are to be retained over roofs to the harbour from the elevated areas of the precinct, including those along Old South Head Road.
- C6 Existing roofscapes (pitched roofs) are to remain uncluttered by intrusive structures so as to not to detract from views to and from elevated areas of the public domain.

### Contributory items

Note: Heritage items as identified in Schedule 5 of Woollahra LEP 2014 are also contributory items. Refer to clause 5.10 of the LEP for heritage conservation controls.

Contributory items	
1 Robertson Place	2 storey Inter-War flat building ‘Keronga’
3 Robertson Place	2 storey Federation semi-detached dwelling
5 Robertson Place	2 storey Federation semi -detached dwelling
7 Robertson Place	2 storey Federation semi -detached dwelling
9 Robertson Place	2 storey Federation semi -detached dwelling
11 Robertson Place	2 storey Federation semi -detached dwelling
13 Robertson Place	2 storey Federation semi -detached dwelling
15 Robertson Place	Single storey Victorian semi -detached dwelling
17 Robertson Place	Single storey Victorian semi -detached dwelling
19 Robertson Place	2 storey Edwardian semi -detached dwelling
21 Robertson Place	2 storey Edwardian semi -detached dwelling
23 Robertson Place	Portions of an early Victorian cottage [1839] within a 3 storey contemporary house
Old South Head Road	Bus shelters

- C7 Contributory items (i.e. includes heritage items) are to be retained.
- C8 Changes to contributory items is limited to sympathetic alterations and additions consistent with the built form controls for contributory items in Section C3.6 of this chapter.

### Inter-War flat buildings or multi dwelling housing

For Inter-War flat buildings, refer to Clause 3.6 Contributory items: additional built form controls.

---

### **Built form**

The following controls apply to new dwellings, or the main new building on the site. Separate controls apply to secondary structures such as new garages, carports, ancillary buildings and the like.

#### ***Building siting and alignment***

##### *Streetfront setbacks*

- C9 Existing streetfront setback patterns are to be maintained, particularly those associated with the group of historic buildings on the north side of Robertson Place (Figure 4).
- C10 New buildings are to be orientated parallel with adjacent properties (not parallel to the street frontage) to maintain existing streetscape patterns.

##### *Side boundary setbacks*

- C11 New buildings adjacent to, and within, Robertson Place are to achieve a similar setback pattern to the contributory items located on the north side of Robertson Place.

#### ***Building height***

- C12 The height of new buildings is to be no greater than the predominant height of contributory items within the streetscape and in any case is limited to two storeys.
- C13 Existing views from the elevated areas of the precinct (from the upper areas of Old South Head Road overlooking Watsons Bay to the harbour) are not to be obstructed by higher development below. New buildings on land fronting Robertson Place are to be no higher than the predominant height of existing buildings.

#### ***Building form***

- C14 Rectilinear plan and traditional pitched roof forms are to be used to relate to the established streetscape character.

#### ***Building materials and details***

- C15 The following materials are appropriate for new buildings:
  - a) Walls: rendered brick or sandstone.
  - b) Pitched roofs (dwellings): slate or tiled with unglazed terracotta or dark earth tones.

### Landscaping and site coverage

- C16 New buildings are to retain and reinforce the typical garden layouts of the front building setbacks with paths, small trees, shrubs and, where space permits, lawns.
- C17 The building footprint plus paved surfaces (patios, pathways, tennis courts and swimming pools together) must not exceed 75% of the site area, in order to provide 25% of the site area for landscaped area, including plantings.

### Fences and walls

- C18 Where existing, original square top picket fencing is to be retained.
- C19 Fencing should be limited to traditional timber paling, or rendered or bagged masonry walls (or, where evidence of previous use exists, composite masonry/timber. Fences should step down in height to 1.2m at front boundary line.

### Car parking and access

- C20 Garages and carports are to be set back behind the front of the main building, preferably at the rear of the property.
- C21 Hardstand car parking spaces are not to be forward of the main building.
- C22 No new garages or carports are to be constructed for existing contributory items, where these would adversely affect the form and presentation of the item.

### C3.4.2 Precinct B: Church Group

#### Character statement

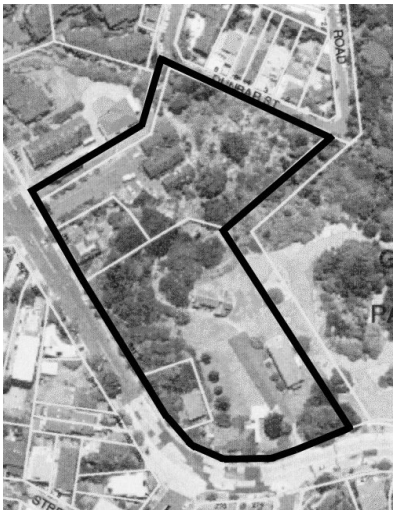
This precinct, bounded by Old South Head Road, Gap Park, Dunbar Street and Vaughan Village, presents one side of the gateway to Watsons Bay. It consists of a predominantly natural landscape with pockets of cultural landscaping and post-1970s native plantings that are sympathetic to those contained within Upper Gap Park (Precinct P) behind.

The precinct civic nature includes a significant group of post 1850s church and former school buildings, located on an exposed rocky plateau. Cultural plantings include figs, palms and coral trees, although only the Moreton Bay fig and very old coral trees have identified heritage value. Private plantings of Oleander and Metrosideros also exist in the street verges.

Low sandstone block perimeter walls line the east side of the Precinct and are a dominant part of the streetscape for this part of Old South Head Road. A section of sandstone kerbing opposite the intersection of Salisbury Street has also been retained.

**FIGURE 6**

Aerial view of the precinct



**FIGURE 7**

Church buildings within a setting of cultural plantings



**FIGURE 8** Sandstone buildings, perimeter walls and entrance, Old South Head Road



**FIGURE 9**

View of precinct from Upper Gap Park



**FIGURE 10** Contributory item on Old South Head Road illustrating dominant materials, including sandstone blockwork and slate roofing.



**FIGURE 11** Low sandstone block memorial wall and entrance



## PRECINCT CONTROLS

The precinct specific controls supplement the general controls for development in Section C3.5. If there is an inconsistency between the precinct controls and the general controls, the precinct controls take precedence.

### Topography and vegetation

- C1 Areas of surviving natural bushland, as well as cultural plantings, are to be retained and reinforced (Figure 9).

### Townscape

- C2 The historic road alignment of Old South Head Road is to be retained.

### Views and vistas

- C3 Existing views of the church buildings (particularly the church and its bell tower, former school and residence) within the surrounding area are to be retained (Figure 9), as identified in Map 4 of this chapter.
- C4 Existing views over roofs to the harbour are to be retained from the upper levels of the precinct, including those from Old South Head Road.
- C5 Roofs are to remain uncluttered by intrusive structures or services so as to retain views to and from the upper levels of the precinct.

### **Contributory items**

Note: Heritage items as identified in Schedule 5 of Woollahra LEP 2014 are also contributory items. Refer to clause 5.10 of the LEP for heritage conservation controls.

C6 Heritage items are to be retained.

### **Built form**

The following controls apply to new dwellings, or the main new building on the site. Separate controls apply to secondary structures such as new garages, carports, ancillary buildings and the like.

#### ***Building siting and alignment***

- C7 Extensive landscaped areas are to be retained between existing buildings of a civic character.
- C8 Location and orientation of new buildings are to be consistent with controls or policies included in any conservation management plan or plan of management applying to the land.
- C9 New buildings are to be located and oriented to be consistent with controls or policies included in any conservation management plan or plan of management applying to the land.

#### ***Building height***

- C10 The height of new buildings is to be equal to, or less than, the ridge line of contributory items (not including spires) within the precinct, but may not exceed two storeys.
- C11 Building heights are to reflect natural landform and topography of the precinct. Existing views from upper levels of the precinct are not to be obstructed by new development.

#### ***Building form***

- C12 The form of new buildings is to relate to that of adjacent contributory items.
- C13 Rectilinear plan and traditional pitched roof forms are to be used to relate to the established streetscape character.

#### ***Building character***

- C14 The design and character of new buildings is to relate to that of contributory items and their civic character and use.
-

### ***Building materials and details***

- C15 The following materials are appropriate for new buildings:
- a) Walls: sandstone or rendered masonry/brickwork of similar tone to sandstone.
  - b) Pitched roofs: slate or tiled in dark grey tones or metal roofs in a slate grey colour.

### **Landscaping and private open space**

- C16 The provision of expansive areas of landscaped area will retain the setting and curtilage of buildings of civic character.
- C17 Plantings around the periphery of the precinct, especially on top of the hard sandstone plateau, are to comprise of substantive native plants commonly found on coastal headlands, including within Gap Park Reserve. Refer to Section 3.5.6 Landscaping and private open space.

### **Fences and walls**

- C18 Front fencing within the precinct is to be limited to low sandstone walls no higher than 0.9m above ground level.
- C19 Where security or privacy is needed, higher sandstone side and rear walls are permitted to a maximum of 1.8m.

### **Car parking and access**

- C20 To retain the open, green character of the precinct, no additional public car parking is to be provided, except where it can be provided within the envelope of new buildings.
- C21 Where possible, existing vehicular access to building complexes within the precinct is to be utilised if new development is required.
- C22 Landscaping and materials used in vehicular parking and access areas within the precinct are to follow guidelines outlined in any conservation management plan and conservation policy relevant to the property and landholding.



### C3.4.3 Precinct C: Vaughan Village

---

#### Character statement

This precinct is bounded by Robertson Place, Old South Head Road, Dunbar Street and the adjoining Church Precinct. It is defined by a stone wall around the perimeter of the Roman Catholic Church property, terminating at a distinctive “Spanish Mission” style substation at the north east corner.

The precinct consists of a complex of contributory items, including the sandstone ‘Our Lady Star of the Sea’ Church, a presbytery, a Spanish Mission-styled substation and the small former St Anthony’s Chapel facing Old South Head Road.

The (non-contributory) retirement village sited around St Anthony’s Chapel is contemporary in character (typical of 1980s brick and tile roofed retirement housing). Although the two to three storey dwellings are divided into small groups, the pattern and form of development is uncharacteristic of the historic subdivision and development pattern of Watsons Bay.

The gardens and landscape that surrounds the retirement housing softens the visual impact of buildings and provide a landscape buffer to the historic church and chapel and include significant sandstone fencing and retaining walls.

**FIGURE 12** Aerial view of the precinct



**FIGURE 13** ‘Our Lady Star of the Sea’



**FIGURE 14** Vaughan Village with the spire of 'Our Lady Star of the Sea' church behind



**FIGURE 15** Spanish Mission-styled electricity substation



**FIGURE 16** View to Vaughan Village from Upper Gap Park



**FIGURE 17** Significant view to church spire from Commercial Precinct



## PRECINCT CONTROLS

The precinct specific controls supplement the general controls for development in Section C3.5. If there is an inconsistency between the precinct controls and the general controls, the precinct controls take precedence.

### Topography and vegetation

- C1 Existing scale relationships of buildings are to be maintained between the higher levels of the precinct (church buildings) and the lower levels (retirement housing), i.e. the church buildings are to retain their visual dominance and landmark value.
- C2 The existing extent of landscaping is to be retained.
- C3 The 'buffer' effect of landscape screening to retirement village housing is to be retained.

### Views and vistas

- C4 Existing views over roofs to the harbour are to be retained from the upper levels of the public domain, including those from Old South Head Road.

- C5 Roofs are to remain uncluttered by intrusive structures or services in order to retain views to and from the upper levels of the precinct.
- C6 Significant public views to the church spire from the public domain are to be retained. This includes views from within the precinct and from adjacent areas, in particular, the Military Road Commercial Centre (Figures 16 and 17).

### Contributory items

Note: Heritage items as identified in Schedule 5 of Woollahra LEP 2014 are also contributory items. Refer to clause 5.10 of the LEP for heritage conservation controls.

#### Contributory items

Lot 1 DP 231114 - facing Dunbar Street	Single storey Interwar Spanish Mission-styled substation #592
---	---

- C7 Contributory items (i.e. including heritage items) are to be retained.
- C8 Change to contributory items is limited to sympathetic alterations and additions consistent with the controls in Section C3.6 and with management policies contained within any conservation management plan applying to the items.
- C9 Given the size of the retirement village and the historic and civic nature of the church buildings and their settings within this area, a conservation management plan should be prepared for each landholding or property listed as a heritage or contributory item. A similar management plan should be prepared for the retirement village. These plans should include consideration of master planning options to provide policies for sympathetic future redevelopment.

### Alterations and additions to existing buildings

- C10 Additions to existing retirement village buildings are to be constructed of the same recessive materials (including wall materials and roof cladding).

### Built form

The following controls apply to new dwellings, or the main new building on the site. Separate controls apply to secondary structures such as new garages, carports, ancillary buildings and the like.

### *Building siting and alignment*

- C11 Extensive landscaped areas are to be retained between existing buildings, particularly the church buildings in the upper level of the precinct.
- C12 No new buildings are to be constructed unless in accordance with an approved management plan. They should be located and orientated to be consistent with policies within any conservation management plan or management plan applying to the land.

### ***Building height***

- C13 The height of new buildings is to be limited to 2 storeys in order to retain the dominance of contributory items within the precinct and to prevent obstruction of significant views to the church spires. No building is to be taller than the ridge line or parapet of adjacent heritage items.
- C14 Building heights are to reflect the natural landform and topography of the precinct. Existing views from the upper levels of the precinct are not to be obstructed by new development (Figure 16).

### ***Building form***

- C15 The height and form of new buildings is to relate to contributory items within the precinct.
- C16 Rectilinear plan forms and traditional pitched roof forms are to be used in order to relate to the established character.

### ***Building character***

- C17 The design and character of new buildings is to relate to that of contributory items in the vicinity.

### ***Building materials and details***

- C18 The following materials are appropriate for new buildings:
- a) Walls: sandstone or rendered masonry or brick in neutral mid-tone colours.
  - b) Pitched roofs: slate or tiled in dark grey tones.

### **Landscaping and private open space**

- C19 Retain setting and curtilage between contributory items through provision of expansive landscaped areas.
- C20 Existing areas of 'buffer' landscaping are to be retained and where possible, new areas created. Refer to Section 3.5.6 - Landscaping and private open space.

### **Fences and walls**

- C21 Fencing within the church area in the upper levels of the precinct is to be limited to low sandstone retaining walls no higher than 0.9m above ground level.
- C22 Perimeter fencing is to be limited to sandstone blockwork of the same height as existing.
- C23 Side and rear fences are not to be constructed in the upper levels of the precinct. Fencing in this area should be used only as a landscape feature or as a gateway to the precinct. Side and rear fencing within the lower levels of the precinct is to be a maximum height of 1.8m, consisting of paling, picket, brick or sandstone (or composite) construction.

### Car parking and access

- C24 In order to retain the open green character of the precinct, additional car parking areas within are not permitted.
- C25 Where possible, existing vehicular access to building complexes within the precinct is to be utilised if new development is required.
- C26 Landscaping of, and materials used in, vehicular parking and access areas within the precinct should be consistent with guidelines included in any conservation management plan or management plan for Vaughan Village.

### C3.4.4 Precinct D: Commercial and residential flat buildings

#### Character statement

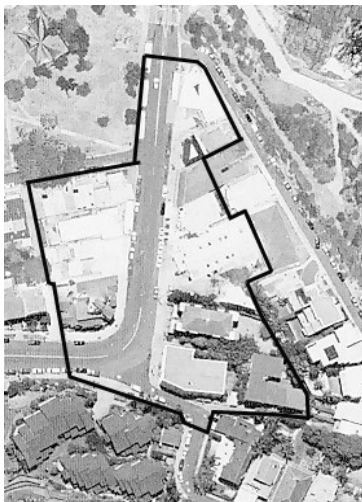
Centred on historic Military Road which linked South Head Road to the defence and navigational establishments and the village of Camp Cove, the precinct extends from Gap Road in the north to Robertson Place in the south, and is bounded by properties with frontage to Military Road (Figure 18).

The precinct contains the Military Road commercial centre of Watsons Bay. The visually distinctive former town hall, built on sites associated with the 1887 subdivision around the later demolished Gap Hotel, is surrounded by a group of residential flat buildings. Buildings are aligned close to or at street frontage, thereby forming a relatively enclosed streetscape (or ‘hard’ built edge) comprising mainly two to three storey buildings set below the high ridge of Upper Gap Park.

The former town hall, a single storey sandstone shop with timber cottage behind, a group of Inter-War shops and residential flat buildings contribute positively to the streetscape. The silhouette of the parapets of the former town hall and Inter-war shops opposite define the streetscape, giving visual prominence to the former town hall and definition to the height of buildings within the streetscape (Figures 19 and 20). The taller height and assertive forms of some of the newer development challenges the prominence of these historic elements within the streetscape.

The Gap Bluff Precinct of the Sydney Harbour National Park and the spire of ‘Our Lady Star of the Sea’ church visually terminate the streetscape at the north and south ends respectively (Figure 21). While the mix of building styles and forms create an architecturally diverse streetscape, it is very uneven in terms of form, character and detail, which detracts from the contributory items within the streetscape.

**FIGURE 18**  
Aerial view of the precinct



**FIGURE 19** West side of Military Road, residential flats and Inter-War shops



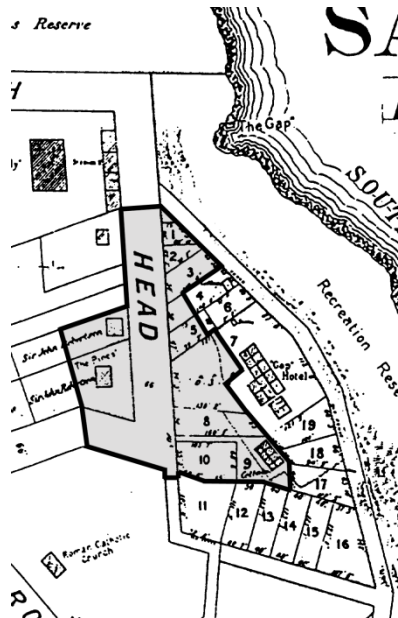
**FIGURE 20** East side of Military Road, with former town hall prominent.



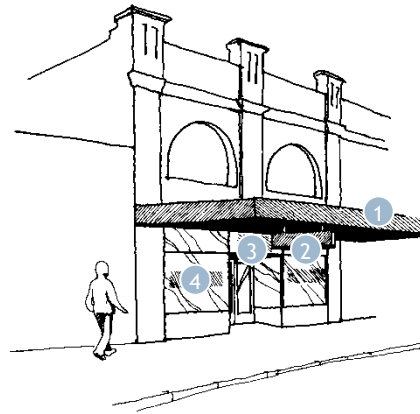
**FIGURE 21** Streetscape with spire above



**FIGURE 22** Extract from the 1887 'Watsons Bay' subdivision plan



**FIGURE 23** An example of appropriate shopfront signage



- 1 Awning fascia sign
- 2 Under awning sign
- 3 Top hamper sign
- 4 Painted or etched window

**FIGURE 24** 25 Military Road with weatherboard cottage (11 Gap Road) behind



**FIGURE 25** East side of Military Road, north of the Town Hall



**FIGURE 26** Looking south towards the Town Hall



## PRECINCT CONTROLS

The precinct specific controls supplement the general controls for development in Section C3.5. If there is an inconsistency between the precinct controls and the general controls, the precinct controls take precedence.

### Topography and vegetation

- C1 New development is not to alter the existing scale relationships between the high natural ridge of Gap Park on the eastern side and the lower scaled buildings below.
- C2 Mixed shrub and groundcover beds in footpaths, as well as private planter boxes attached to building facades or on low walls, detract from the streetscape and should be removed.

### Townscape

- C3 The surviving subdivision pattern is to be retained, including width and depth of allotments that provides evidence of 1887 subdivision around the Gap Hotel (Figure 22).
-



- 
- C4 The overall consistency of building alignment is to be retained (i.e. built close to or at the street frontage).
  - C5 The cohesiveness of the centre is to be reinforced. New development is to respect the scale, massing and architectural character of adjacent heritage and contributory items.
  - C6 Infill development within the neighbourhood business zone is to be of traditional 'main street' form, with shops at ground level and housing or commercial space above.
  - C7 The location of outdoor footpath dining must maintain continuity of public access.
  - C8 The number of signs is to be limited to avoid visual clutter on individual premises and within the streetscape.

### **Signage and advertising (commercial buildings)**

#### *Signs are to be:*

- C9 Located at ground level on shopfronts (hampers), awnings and under awnings (Figure 23).
- C10 Designed to fit within the existing architectural elements of buildings and not obscure architectural features.
- C11 Designed to an appropriate size and scale for the building on which they are to be erected.
- C12 Painted and, where illumination is desired, externally spot lit.
- C13 Fixed to buildings in a manner that does not damage significant building fabric.

#### *Signs are to:*

- C14 Identify the building and its use only. General trade advertising signs are not permitted.
- C15 Incorporate style, lettering and colours that complement the style and character of the building to which they are attached.

#### *Signs are not to be:*

- C16 Located on windows other than to indicate the name and nature of the business. Window signs are to be discrete and of a professional design quality. Views to the interior of the building are not to be obscured unduly.
- C17 Fixed above awning level.
- C18 Painted on previously unpainted surfaces of heritage and contributory items.
- C19 Standardised corporate signage.
- C20 Internally lit, neon or with flashing lights. Small and discrete internally illuminated signs may be installed within shopfronts.

### Views and vistas

- C21 Existing public views over roofs to the harbour from Gap Park are to be retained, including views from the former tram corridor.
- C22 The vista from Military Road to Gap Park and cottage behind the sandstone commercial building at 25 Military Road is to be retained (Figure 24).
- C23 Roofs are to remain uncluttered by intrusive structures and services in order not to detract from the significant views from Gap Park towards the harbour.

### Contributory items

Note: Heritage items as identified in Schedule 5 of Woollahra LEP are also contributory items. Refer to clause 5.10 of the LEP for heritage conservation controls.

Contributory items	
3 Military Road	2 storey 1920s Inter-War flat building over retail
10 Military Road	2 storey Federation styled housing over retail
12A Military Road	2 storey Federation styled housing over retail with original shopfront

- C24 Contributory items (i.e. includes heritage items) are to be retained.
- C25 Change to contributory items is limited to sympathetic alterations and additions consistent with the controls in Section C3.6.
- C26 Reconstruction of the original window configuration in the Inter-War period shops group is encouraged and should occur concurrently when development is proposed for those buildings.
- C27 Original significant shopfronts at 10 Military Road are to be retained.
- C28 Existing setbacks from the street are to be maintained.

### Built form

The following controls apply to new dwellings, or the main new building on the site. Separate controls apply to secondary structures such as new garages, carports, ancillary buildings and the like.

#### ***Building siting and alignment***

##### *Street front and side boundaries – east side*

- C29 New buildings are to be built to the street alignment to the north of the former Town Hall, with exception of the allotment immediately adjacent (Figure 25). South of the former town hall building, new buildings are to be set back to match the existing residential flat building alignment, up to the corner site, which should be built to the street alignment (Figure 26).

---

### *Street front and side boundaries – west side*

- C30 New buildings are to be built to the street alignment and to side boundaries on all levels. Existing gaps in the street wall are to be infilled when further development occurs to those properties.

### *Rear setbacks*

- C31 Building setbacks from rear should relate to existing setback pattern on adjoining blocks and maintain amenity of neighbouring residential property.

### ***Building height***

Note: Maximum building height is specified in Woollahra LEP 2014.

### ***Building form***

- C32 New buildings are to be built with parapeted rectilinear forms in order to relate to similar contributory items and to achieve greater unity within the streetscape.
- C33 New building forms are not to be so visually assertive in the streetscape that the historic character is eroded.
- C34 New buildings on the west side of Military Road are to be constructed with awnings.
- C35 New buildings on the east side of Military Road are to be subservient in form and height to those of the former town hall in order to retain its visual prominence in the streetscape.
- C36 The location and mix of uses in the precinct should ensure adequate residential amenity in terms of sunlight access and visual and acoustic privacy.

### ***Building character***

- C37 Facades are to be modulated into vertically proportioned bays and openings.

### ***Building materials and details***

- C38 Walls above awnings are to be rendered and painted masonry. Sandstone or ceramic tiles are permitted at ground level.

### **Landscaping and site coverage**

#### *Commercial buildings*

- C39 Landscaping is not appropriate at street frontage.

---

*Residential flat buildings, manor houses, multi dwelling housing and multi dwelling housing (terraces)*

- C40 Landscaped area is permitted in front of residential flat buildings, manor houses, multi dwelling housing and multi dwelling housing (terraces), except at the street corners.
- C41 The building footprint plus paved surfaces (patios, pathways, tennis courts) and swimming pools together must not exceed 75% of the site area in order to provide 25% of the site area for landscaped area, including planting.
- C42 Planting should be carefully selected to ensure that the mature height and canopy spread is not excessive for the limited space available. Refer to Section 3.5.6 Landscaping and private open space.

**Fences and walls**

- C43 Low masonry walls of a maximum height of 1.2m are to be provided along the street alignment to new residential development on the east side, south of the town hall. Materials are to be sandstone or match the building finish to which they relate.
- C44 Side and rear fences, when not street fronting, are to be traditional timber paling fences or masonry walls of 1.8m maximum height, rendered and painted.

**Car parking and access**

- C45 No new driveways from Military Road are permitted.
- C46 No new garages are permitted on the street frontage.
- C47 The existing multiple garages fronting the east side of Military Road are to be replaced/relocated when development occurs to those sites.

**Site facilities and aerial devices**

- C48 Servicing of the commercial buildings is to be provided from the rear, where possible.

**Inter-War flat buildings or multi dwelling housing**

For Inter-War flat buildings, refer to Clause 3.6 Contributory items: additional built form controls.

---

### C3.4.5 Precinct E: Gap Road/Dunbar Street

---

#### Character statement

The precinct is bounded by the historic road alignments of the present Gap Road and Dunbar Street, along the boundaries of early land grants to the east and south. The development pattern provides evidence of the 1887 subdivision and development around the Gap Hotel, including the former Masonic Hall, built on the site of the demolished hotel.

The streetscape, enclosed by two narrow roads at the base of Gap Reserve, features buildings set close to the street on one side, and a cliff face on the other. These are bordered by native plants at various stages of maturity among sandstone outcrops.

There are very few cultural plantings within the public domain, most being native plantings that have joined with existing native vegetation in Upper Gap Park above.

Contrasts between buildings create four visually distinctive components that contribute to the present character:

1. Single storey cottages dating from the late 19th century to early-mid 20th century at the southern end of Gap Road and the north side of Dunbar Street (Figure 29).
2. Two storey Victorian timber cottages on Gap Road (originally single storey) with later additions, built close to the street frontage, forming a small cohesive group (Figure 30).
3. The rear of the former Masonic Lodge is at the north end of Gap Road and is surrounded by, two and three storey non-contributory residential and commercial buildings (Figure 31).
4. An early Federation, single storey timber cottage at the rear of 25 Military Road (11 Gap Road), which also forms part of Precinct E, its setting diminished by the tall blank end walls of adjacent contemporary buildings (Figure 33).

Buildings are set behind a range of different fences that vary in height and materials. The streetscape is enhanced by vistas to the church spires and Upper Gap Park from Dunbar Street. The streetscape is disrupted by intrusive later buildings and structures, including unsympathetic garages along the street front.

**FIGURE 27** Aerial view of the precinct



**FIGURE 28** Gap Road with Upper Gap Park at right



**FIGURE 29**  
Single storey cottages on Dunbar Street



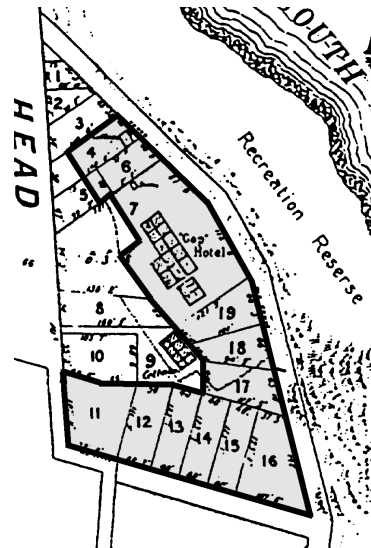
**FIGURE 30** Group of two storey Victorian timber cottages on Gap Road



**FIGURE 31**  
Rear of the former Masonic Lodge with residential flats adjacent



**FIGURE 32** Extract from the 1887 'Watsons Bay' subdivision plan



**FIGURE 33** Early Federation period weatherboard cottage at the rear of 25 Military Road (11 Gap Road)



**FIGURE 34** Two storey weatherboard cottages on Gap Road



**FIGURE 35** Single storey scale of built form in Dunbar Street



**FIGURE 36** Buildings in Gap Road North



## PRECINCT CONTROLS

The precinct specific controls supplement the general controls for development in Section C3.5. If there is an inconsistency between the precinct controls and the general controls, the precinct controls take precedence.

### Topography and vegetation

- C1 New development is not to alter the existing scale relationships between the high natural ridge of Upper Gap Park on the east side and the lower scaled buildings below.
- C2 Vehicular laybys and parking spaces are not to be carved out of the public reserve sides of the streets.
- C3 No street verge plantings are to be introduced within this precinct as the roads and footpaths are too narrow.

### Townscape

- C4 The remaining subdivision pattern is to be retained, including the width and depth of allotments. This will provide evidence of the 1887 subdivision around the Gap Hotel (Figure 32).
- C5 The visual prominence of the rear of the former Masonic Lodge is to be retained.

### Views and vistas

- C6 The height of new buildings, and additions to existing buildings, is to be limited in order to ensure that public views are retained over roofs from Gap Park to the harbour including views from the former tram corridor.
- C7 Roofscapes are to remain uncluttered by intrusive structures or services such as satellite dishes and air conditioners, in order not to detract from views from Gap Park over the precinct to the harbour.
- C8 Fences adjoining the timber cottage at the rear of 25 Military Road (11 Gap Road) are to be sufficiently transparent to retain views to this item.

### Contributory items

Note: Heritage items as identified in Schedule 5 of Woollahra LEP 2014 are also contributory items. Refer to clause 5.10 of the LEP for heritage conservation controls.

Contributory items	
2 Dunbar Street	Single storey Victorian weatherboard cottage
4 Dunbar Street	Single storey semi -detached Edwardian dwelling
5 Dunbar Street	Single storey semi-detached Edwardian dwelling
2 Gap Road	Single storey Victorian weatherboard semi-detached dwelling extended to 2 storey
3 Gap Road	Single storey Victorian weatherboard semi-detached dwelling extended to 2 storey
4 Gap Road	Single storey Victorian weatherboard semi -detached dwelling extended to 2 storey
8 Gap Road	2 storey Federation Italian renaissance styled former Masonic lodge

- C9 Contributory items (i.e. heritage items and contributory items) are to be retained.
- C10 Changes to contributory items is limited to sympathetic alterations and additions consistent with the controls in Section C3.6.



---

## Built form

The following controls apply to new dwellings, or the main new building on the site. Separate controls apply to secondary structures such as new garages, carports, ancillary buildings and the like.

### *Building siting and alignment*

*Streetfront and side boundaries - Gap Road, south, and inclusive, of No.5 and the north side of Dunbar Street*

- C11 New buildings are to be set back in line with adjacent contributory items and provide for landscaped area in front yards behind fences or walls.
- C12 The front walls of new buildings are to be orientated parallel with the street frontage, in order to distinguish the group of early cottages on Gap Road.

*Streetfront and side boundaries - Gap Road, north of No 5, commencing at No. 6*

- C13 New buildings are to be set back to match or stand behind the front wall of the former Masonic Lodge in order to maintain its visual prominence in the streetscape, with the exception of the corner site, which should be built to the street alignment.

### *Rear setbacks*

- C14 The rear alignment of buildings is to be similar to adjacent development and maintain the amenity of neighbouring residential property.

### *Building height*

- C15 Building height is not to exceed two storeys and is not to visually disrupt the cliff line when viewed from the Harbour.

*Gap Road south, and inclusive, of No.5 and the north side of Dunbar Street.*

- C16 Any new buildings on Gap Road are to relate sympathetically to the scale of the significant timber cottage.
- C17 A single storey scale is to be maintained along Dunbar Street, as viewed from the street, to relate sympathetically to the established scale of the streetscape.

*Gap Road, north of No. 5, commencing at No 6*

- C18 New buildings on the west side of Gap Road, are to be within the height plane established by the eaves line of the former Masonic Lodge, in order to retain its visual prominence in the streetscape (Figure 33).
- C19 The height of development is to be stepped down to two storeys on the lot adjoining the timber cottage (rear of 25 Military Road) to provide a transition in scale between the three storey and single storey building.

### **Building form**

#### *Gap Road south, and inclusive, of No.5 and the north side of Dunbar Street*

C20 The form and scale of new buildings is to respect the massing of adjacent significant dwellings. Traditional pitched roof forms, such as hips and gables, are to be used.

#### *Gap Road, north of No.5, commencing at No. 6*

C21 Rectilinear or cubic forms are to be used to relate to the established character (Figure 36).

C22 The mass of new buildings is to be broken up to avoid long uninterrupted parapet lines.

C23 The mass of side walls is to be broken up adjacent to contributory items including the weatherboard cottage, to avoid large blank walls, and to provide an appropriate setting for the cottage (Figure 33).

### **Building character**

#### *Gap Road south, and inclusive, of No.5 and the north side of Dunbar Street*

C24 New buildings are to relate to the character established by adjacent significant detached and semi-detached dwellings.

#### *Gap Road, north of No.5, commencing at No 6*

C25 New buildings are to relate to the character established by the well-articulated dwellings and residential flats (Figure 36).

### **Building materials and details**

C26 The following materials are appropriate for new buildings:

- a) Walls: Painted or exposed weatherboards for dwellings, or rendered and painted brickwork or masonry for larger buildings.
- b) Pitched roofs for small dwellings: corrugated steel, slate, tiles in unglazed terracotta or dark earth tones.

### **Landscaping and site coverage**

C27 Planting should be carefully selected to ensure that the mature height and canopy spread will not be excessive and will not block views to the harbour from the adjacent Gap Park. Refer to Section 3.5.6 Landscaping and private open space.

C28 The building footprint plus paved surfaces (patios, pathways, tennis courts and swimming pools together) are not to exceed 80% of the site area. This is in order to provide 20% of the site area for landscaped area, including plantings.

---

*Residential flat buildings, manor houses, multi dwelling housing and multi dwelling housing (terraces)*

- C29 For residential flat buildings, manor houses, multi dwelling housing (terraces) and multi dwelling housing, the building footprint plus paved surfaces (patios, pathways, tennis courts and swimming pools together) are not to exceed 70% of the site. This is area in order to provide 30% of the site area for landscaped area, including plantings.

### Fences and walls

*Gap Road south, and inclusive, of No.5 and the north side of Dunbar Street*

- C30 Front fences are to be 1.2m max in height. Materials and detailing are to be in keeping with the building to which they relate, including rendered and painted masonry and wooden pickets, where relevant.

*Gap Road north of No.5, commencing at No.6*

- C31 Fences are to be articulated masonry walls, 1.5m maximum in height, with 50% transparency above 1.2m in height.

*Rear boundary fences*

- C32 Rear boundary fences, where the rear boundary is not at street frontage, are to be 1.8m maximum traditional timber paling fences or rendered masonry walls.

### Car parking and access

- C33 Garages and carports are not to be built to street alignment, and are to be set back behind the building whether attached or free-standing. The exception to this condition is the timber weatherboard cottage at the rear of 25 Military Road, which is subject to heritage considerations.

### Site facilities and aerial devices

- C34 Site servicing to commercial buildings on Military Road that do not have access to Gap Road to be provided from kerbside parking in Military Road.

### C3.4.6 Precinct F: Clovelly Street

#### Character statement

The precinct extends from the rear of the commercial building at the corner of Military Road and encompasses the residential properties on the south side of Clovelly Street. Two distinct groups of one and two storey buildings form a low-scaled built edge to the adjacent major landscaped open spaces, Robertson Park and Robertson Place.

The groups, set back slightly from the street frontage and stepping down toward the open space around Dunbar House, establish a repetitive rhythm in the streetscape. Views to the water are filtered through the trees that line Robertson Park on the north side of the street (Figure 38).

The two groups comprise:

- A pair of two storey semi-detached dwellings that have been substantially altered at Nos. 1 and 2 Clovelly Street. They provide a transition in scale from the taller commercial building on the corner with Military Road to the single storey pairs of semi-detached dwellings further to the east.
- A group of single storey semi-detached dwellings (dating from 1908) with simple hipped roof and verandah form, that provide a sympathetic built edge to Robertson Park and define the curtilage of Dunbar House (Figure 39). Within this group is a pair of non-contributory newer semi-detached dwellings that have a different scale, form and character to contributory items in the group, particularly in oblique views (Figure 40).

Although altered, the form and detail of the original buildings can still be understood. There is potential to recover more of their original character by encouraging the removal of unsympathetic alterations and the reconstruction of missing elements.

**FIGURE 37** Aerial view of the precinct



**FIGURE 38** Precinct streetscape



**FIGURE 39** One of three pairs of single storey semis



**FIGURE 40** One of three pairs of single storey semis



**FIGURE 41** View from Robertson Park



**FIGURE 42** View from Robertson Place



**FIGURE 43** Side boundary setbacks wide enough for parking at side of houses



## PRECINCT CONTROLS

The precinct specific controls supplement the general controls for development in Section C3.5. If there is an inconsistency between the precinct controls and the general controls, the precinct controls take precedence.

### Topography and vegetation

- C1 The planting of street trees in the footpath in front of the cottages is not permitted due to the narrow width of the pedestrian area and because street plantings on the south of Clovelly Road would obscure the cottages from Robertson Park detracting from their contribution to the streetscape.

### Townscape

- C2 The existing allotment size and configuration are to be kept in order that the early, small-scale ‘cottage’ character of the precinct remains.
- C3 The low-scaled backdrop and transition to the parks formed by two groups of one and two storey buildings is to be retained (Figures 41 and 42).
- C4 The overall consistency of housing is to be retained. This encompasses the repetitive rhythm of the two groups of buildings in the streetscape established by the building height, form, alignment and character, including the hipped roofs, open verandahs at ground floor and the side setbacks of the original single storey semi-detached dwelling, which are wide enough to accommodate parking (Figure 43).
- C5 All original sandstone kerbing and guttering is to be retained in front of the cottages.

### Views and vistas

- C6 Roofs are to remain uncluttered by intrusive structures and services so as not to detract from public views from Robertson Park, or from views to the harbour from more elevated portions of the public domain above.

### Contributory items

Note: Heritage items as identified in Schedule 5 of Woollahra LEP 2014 are also contributory items. Refer to clause 5.10 of the LEP for heritage conservation controls.

Contributory items	
5 Clovelly Street	Single storey Edwardian semi-detached dwelling
6 Clovelly Street	Single storey Edwardian semi-detached dwelling
7 Clovelly Street	Single storey semi-detached dwelling
8 Clovelly Street	Single storey semi-detached dwelling
9 Clovelly Street	Single storey semi-detached dwelling
10 Clovelly Street	Single storey semi-detached dwelling

- 
- C7 Contributory items (i.e. including heritage items) are to be retained.
  - C8 The single storey semi-detached dwellings are to be retained, subject to detailed investigation of their historical significance, (particularly their association with Sir John Robertson.
  - C9 Change to contributory items is limited to sympathetic rear alterations and additions consistent with the controls in Section C3.6.

### **Built form**

The following controls apply to new dwellings, or the main new building on the site. Separate controls apply to secondary structures such as new garages, carports, ancillary buildings and the like.

#### ***Building siting and alignment***

##### *Streetfront and side boundaries*

- C10 Existing alignments within each group are to be matched, including the wide side boundary setbacks of the single storey semi-detached dwellings.

##### *Rear setbacks*

- C11 New buildings are to relate to the existing setback pattern and maintain the amenity of neighbouring residential properties.

#### ***Building height***

- C12 New buildings are to match existing heights within each group.

#### ***Building form***

- C13 Streetscape continuity is to be retained by following established forms within each group.

#### ***Building materials and details***

- C14 The following materials are appropriate for new buildings:
  - a) Walls: rendered or painted brickwork or masonry.
  - b) Pitched roofs: slate or tiled to reflect original unglazed terracotta or in dark earth tones. No dormer or recessed balconies within the front roof form.

### **Landscaping and site coverage**

- C15 The building footprint plus paved surfaces (patios, pathways, tennis courts) and swimming pools together are not to exceed 80% of the site area in order to provide 20% of the site area for landscaped area, including plantings.
  - C16 Planting at the rear is to be small scaled to fit the small space available. Refer to Section 3.5.6 Landscaping and private open space.
-

### Fences and walls

- C17 Fencing on the street frontage is to be limited to 1.2m maximum height so as to retain views to and from dwellings. Existing sandstone base walls are to be retained.
- C18 Rear and side fences are to be of 1.8m maximum traditional timber paling fences or preferably rendered, masonry walls.
- C19 Side fencing facing Robertson Place is to be built with a sandstone base to 0.6m with maximum 1.5m timber paling above.
- C20 Appropriate front fencing types are illustrated in Section 3.5.7 Fences and walls.

### Car parking and access

- C21 No new driveways are permitted from Clovelly Street.
- C22 Existing driveway arrangements are to be retained for the single storey semi-detached dwelling (that is, parking within open carports at the side behind the front wall of the dwelling).



### C3.4.7 Precinct G: Marine Parade North

#### Character statement

Part of 'The Town of Watsons Bay' subdivision in 1855, the precinct is bounded by Short Street to the north, Cliff Street to the east and Military Road to the south. The western boundary is formed by the waterfront promenade of Marine Parade which curves along a sandy beach contained by the wharf at its south end and a walled pedestrian link to Short Street at its north end.

Within the precinct is a range of mainly one and two storey 20th century housing on allotments of varied size and configuration, many of which can be traced back to the original subdivision. Houses generally have pitched roof forms, setbacks from side boundaries, and fenced garden space to the front and rear. Exceptions are the single storey Edwardian period Sydney Water Pumping Station at the northern end and the large Watsons Bay Hotel at the southern end of the precinct. The latter has recently been extended to three storeys, and has an adjacent restaurant. Both the hotel and pumping station are uncharacteristic, but nevertheless contributory to the historic values of the area.

Viewed from the harbour the houses are set behind a wide variety of promenade walls and fencing, backed by various types and heights of private planting (Figure 45). The houses are of relatively consistent height at ridgeline. Watsons Bay Hotel at the south end and the roof of No. 2 Short Street together with the adjacent 'Portuguese Terraces in Cove Street at the north end form 'bookends' with the smaller houses in between. The lower height of the buildings between the 'bookends' and the National Park ridgeline permits views of a deep landscaped backdrop of coral trees and National Park vegetation above the roofs (Figure 46).

Viewed from Cliff Street, the streetscape is dominated on the west side by a wide variety of fencing types, heights, materials and colours with some 2m high walls for garages that provide a dissonant edge to the west side of Cliff Street (Figure 47). The street opens up to a large car park at the south end that breaks from the early subdivision pattern. Coral trees and sections of the sandstone cliff face within the National Park form a natural enclosure to the streetscape on the east side.

**FIGURE 44** Aerial view of the precinct



**FIGURE 45** View of Marine Parade from the ferry wharf



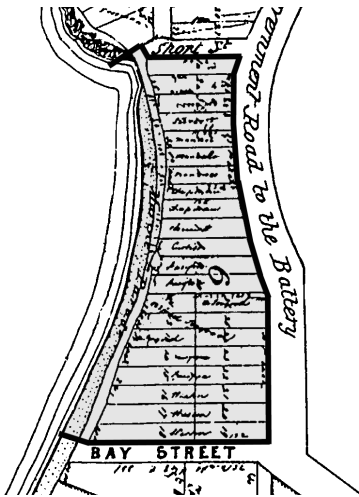
**FIGURE 46** View of precinct from the water showing 'bookend' principle



**FIGURE 47** Cliff Street frontage



**FIGURE 48** Extract from 1855 'Town of Watsons Bay' subdivision plan



**FIGURE 49** Promenade wall



**FIGURE 50** Dinghies located on the edge of the promenade



**FIGURE 51** Water pumping station at north end of Marine Parade



**FIGURE 52** Fencing along Marine Parade

### PRECINCT CONTROLS

The precinct specific controls supplement the general controls for development in Section C3.5. If there is an inconsistency between the precinct controls and the general controls, the precinct controls take precedence.

#### Topography and vegetation

- C1 A landscaped edge is to be introduced between the car park and the commercial properties facing Cliff Street.
- C2 Street trees are not to be planted within the narrow footpath on the west side of Cliff Street.

#### Townscape

- C3 The small lot subdivision pattern is to be retained to respect the original 1855 subdivision (Figure 48).
- C4 The height of existing buildings between the 'bookends' is to be maintained so that views from the harbour will retain a deep landscaped backdrop of coral trees and National Park vegetation.
- C5 The 'bookend' height is not to be further extended into the precinct.
- C6 The sense of enclosure within Cliff Street, formed by the natural features on the east side and fences and walls on the west side, is to be retained. The appearance of these fences and walls should be improved and upgraded when new development is proposed.
- C7 The building of large expanses of car park and the amalgamation of sites for commercial development are not permitted. These would disrupt the historic, small-lot subdivision pattern for detached dwellings and detract from the townscape.

- C8 Should redevelopment of a mixed use nature occur, residential uses should front Cliff Street and commercial or retail uses should front Military Road.
- C9 Signage at the ferry wharf and within the hotel and restaurant complex is to be in accordance with the signage policy developed for the Military Road Commercial Centre (Precinct D).
- C10 All sandstone kerbing and guttering near the corner of Cliff and Short Streets is to be retained.
- C11 Sandstone retaining walls along the promenade are to be kept.

#### The waterfront

- C12 Views of houses, roofs and gardens from promenade and Harbour are to be retained, unobstructed by high fences subject to privacy considerations.
- C13 No new window openings are to be made in the boundary walls facing the Marine Parade promenade. When new development is proposed, existing glazed openings are to be modified to solid doors, gates, walls etc. so as to relate sympathetically to the maritime character as boatsheds, not shopfronts (Figure 49).
- C14 No further increase is permitted in the existing height or bulk of the wharf building or the commercial buildings at the south end of the precinct.
- C15 To prevent privatisation of the public domain, commercial development and related functions, where permissible) are to be contained within existing private property.
- C16 To prevent privatisation of the public domain, the size of existing footpath areas leased for restaurant or other private uses should not be increased.
- C17 All fittings and fixtures, including furniture visible from the promenade, beach or harbour, are to be of a high design quality.
- C18 Commercial signs are not permitted in the public domain. Identification signs are to be discreet.
- C19 Beached dinghies are permitted against the promenade edge provided these do not impede access within the public domain.

#### Views and vistas

- C20 View sharing is to be retained, both within this precinct and with properties in adjacent precincts that overlook the precinct.

### Contributory items (including heritage items)

Note: Heritage items as identified in Schedule 5 of Woollahra LEP 2014 are also contributory items. For the protection of heritage items refer to clause 5.10 of the LEP.

Contributory items	
10 Marine Parade	2 storey Art Deco styled hotel with third floor addition
11-13 Marine Parade	2 storey weatherboard restaurant with historic values
18-19 Marine Parade	Single storey Inter-War semi-detached dwelling
20-21 Marine Parade	Single storey Inter-War semi-detached dwelling
22 Marine Parade	Single storey Victorian weatherboard cottage

C21 Heritage items and contributory items are to be retained.

C22 Change to contributory items is limited to sympathetic alterations and additions consistent with the controls in Section C3.6.

### Alterations and additions to existing buildings

#### *Watsons Bay Hotel and Doyle's Restaurant*

C23 A conservation management plan is to be prepared for the Watsons Bay Hotel and the adjacent restaurant site. This should include consideration of master planning options and provide policies for appropriate future development of the sites, having regard to their heritage significance.

C24 Future proposals for alterations and additions are to comply with a conservation management plan adopted by Council.

### Built form

The following controls apply to new dwellings, or the main new building on the site. Separate controls apply to secondary structures such as new garages, carports, ancillary buildings and the like.

#### *Building siting and alignment*

##### *Front (waterfront) setbacks*

C25 All buildings are to be setback from Marine Parade to provide for a garden space between the house and the promenade. The setback is to relate to the adjacent dwellings with the exception of the existing early cottage at No. 22 which is built to the Marine Parade boundary.

*Streetfront setbacks - Cliff Street*

- C26 New buildings are to be set back two metres minimum from Cliff Street to provide for a garden space, either as a front or rear yard.
- C27 A single garage may be built to the Cliff Street frontage provided it is integrated visually with the fence or wall and leaves 50% of the width of the street frontage for landscaped area to appear over the fence or wall.

*Side boundary setbacks*

- C28 All buildings north of the existing Watsons Bay Hotel and Doyle's Restaurant buildings, including garages, are to be set back from side boundaries by 1.2m minimum (1.5m minimum for lots greater than 15m in width). This is in order to retain the detached dwelling character of the precinct and provide opportunity for views between the buildings to the harbour.

*Rear setbacks*

- C29 Rear setbacks are to relate to the existing setback pattern, to provide rear yard space and maintain the amenity of neighbouring residential property.

***Building height***

- C30 Buildings are to be a maximum of two storeys, with roofs pitched to match traditional forms.
- C31 The overall height of new buildings, measured to the ridgeline, is not to exceed the predominant height of existing buildings between the 'bookends' when viewed from the harbour.

***Building form***

- C32 New buildings are to follow the established forms of housing north of Doyle's Restaurant. These are small scale, rectilinear buildings of traditional form with pitched roofs.
- C33 Flat roofed, or parapeted, buildings are not permitted.
- C34 Roof ridgelines are to be parallel to side boundaries in order to minimise the visual impact of the roofs on public views and when viewed from Marine Parade or the waterfront.

***Building character***

- C35 The architectural treatment of new buildings is not to contrast markedly with the established character of the area.
- C36 New buildings on lots adjacent to the existing Watsons Bay Hotel and Doyle's Restaurant buildings are to relate to the detached dwelling character of the precinct and not to the commercial buildings.

- 
- C37 The following materials are appropriate for new buildings:
- a) Walls: weatherboard, exposed brickwork or rendered or painted brickwork or masonry.
  - b) Roofs: corrugated steel, slate, or tiles in unglazed terracotta or dark earth tones.

### Landscaping and site coverage

- C38 The building footprint plus paved surfaces (patios, pathways, tennis courts) and swimming pools together are not to exceed 75% of the site area in order to provide 25% of the site area for landscaped area, including plantings.
- C39 Mature historic plantings are to be retained.
- C40 In this relatively old cultural landscape, native species other than blueberry ash and lillypilly are not permitted. Refer to Section 3.5.6 - Landscaping and private open space.

### Fences and walls

#### *Marine Parade*

- C41 Fence heights are to be a maximum 1200mm above promenade level, or, where privacy from the promenade is an issue, up to 1.8m maximum with 50% transparency above 1.2m. Materials should be sandstone or face brick or rendered or painted masonry in keeping with building to which it relates (Figure 52).

#### *Short Street and Cliff Street*

- C42 Fences are to be a maximum of 1.5m above footpath level, with 50% transparency above 1.2m. Materials should be traditional timber pickets, brick or masonry, rendered or painted as appropriate to building.
- C43 Garages, driveway doors and pedestrian gates are to be designed as an integral part of the fence or wall. Brick or rendered masonry garages without lofts may be combined with timber fences.

#### *Military Road*

- C44 Fences are to be low height walls, 1.2m maximum above footpath level and constructed from materials and style appropriate to the building.

#### *Rear and side fences (when not street fronting)*

- C45 Fences are to be traditional timber paling fences no greater than 1.8m in height.

### Car parking and access

- C46 A maximum of one single garage or vehicular access door is permitted, plus one pedestrian door per property on the Cliff Street frontage.
- C47 Servicing of waterfront properties is to be via existing driveways/right of ways.

### C3.4.8 Precinct H: Victoria Street Waterfront

#### Character statement

Part of the 1855 ‘The Town of Watsons Bay’ subdivision, the precinct is bounded by Cliff Street, Victoria Street and the Marine Biological Research Station, together with the water frontage of Camp Cove Beach. Camp Cove Beach is enclosed by the knoll of Green (Laings) Point to the south and the Sydney Harbour National Park to the north (Figure 52).

The precinct contains a variety of mostly detached one and two storey houses on separate allotments, including a number of early buildings. The original subdivision pattern was not fully realised, however, there are a number of allotments of a consistent size that provide evidence of the original layout.

Buildings are viewed from the water against a deep backdrop of coral trees and National Park vegetation. A number of buildings within HMAS Watson detract from the backdrop, especially the long, new buildings situated along the ridge top. Early buildings with traditional verandahs and pitched roofs, enhance the maritime character.

The setting of the houses is also enhanced by cultural plantings, including Norfolk Island pines and palms, within walled front yards facing the beach and occasionally in the rear or Victoria Street garden areas (Figures 54 and 55). Viewed from Victoria Street, the high walls and dwellings/garages built to the street frontage give a built edge to the east side, softened by pockets of planting within yards. The high impermeable walls detract from the streetscape. A number of buildings with garages, including two storey structures, extend to Victoria Street alignment with no space for landscaping to soften their visual impact.

**FIGURE 53**  
Aerial view of the precinct



**FIGURE 54**  
Camp Cove beach from Green (Laings) Point Reserve

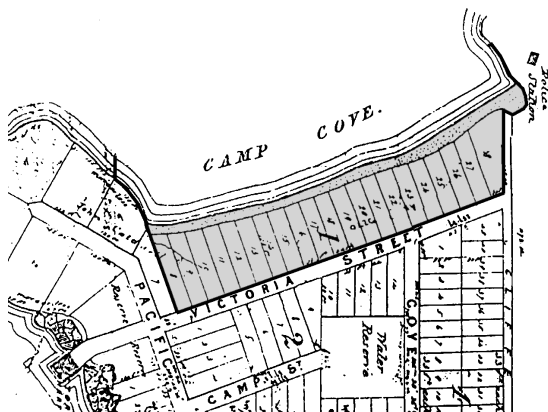




**FIGURE 55** Traditional building forms enhanced by cultural plantings at east end of Camp Cove Beach



**FIGURE 56** Extract from 1855 'Town of Watsons Bay' subdivision plan



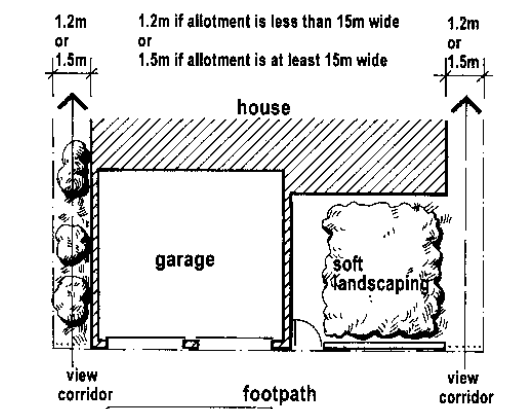
**FIGURE 57** Victoria Street frontage



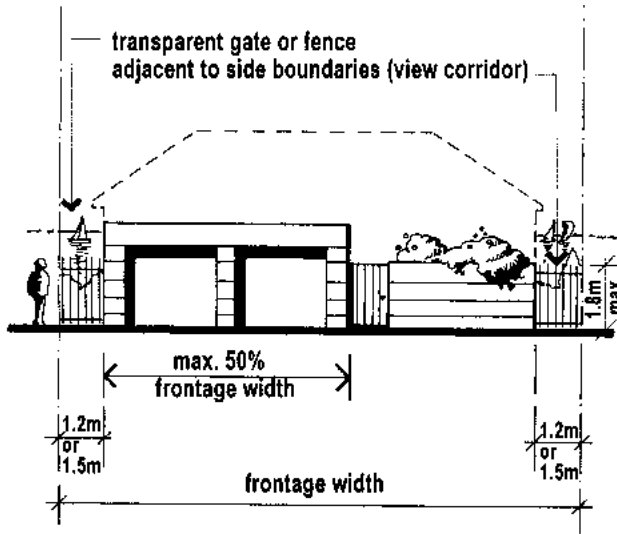
**FIGURE 58** Camp Cove Beach frontage



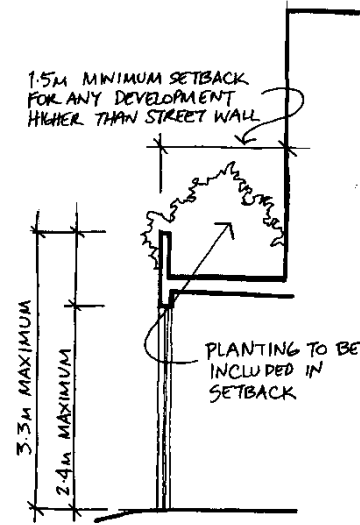
**FIGURE 59** Side boundary setbacks



**FIGURE 60**  
Garages on Victoria Street frontage



**FIGURE 61** Maximum heights and setbacks for street walls



## PRECINCT CONTROLS

The precinct specific controls supplement the general controls for development in Section C3.5. If there is an inconsistency between the precinct controls and the general controls, the precinct controls take precedence.

### Topography and vegetation

- C1 Significant cultural plantings in properties along the beachfront are to be retained.
- C2 New plantings are to be appropriate in scale to available space.
- C3 The likely mature size of canopies of proposed plantings are to be taken into account and those that may obscure views to the HMAS Watson bushland and tree lined ridge and National Park from the Harbour are not permitted.

### Townscape

- C4 New site development is to be sited to achieve three visually distinct zones similar to most properties, that is:
  - a) landscaped setback at beachfront;
  - b) building zone of one and two storey detached houses with setbacks from side boundaries; and
  - c) landscaped edge to Victoria Street.
- C5 The predominant existing pattern of detached dwellings on separate allotments is to be retained to respect the existing subdivision and development pattern.

- C6 The general scale established by existing buildings is to be maintained to retain views from the water of the backdrop of coral trees and National Park vegetation.
- C7 New development is to increase permeability from the street to the water and provide a view corridor to the Harbour along the sides of the building.
- C8 All sandstone kerbing and guttering within Victoria Street is to be retained.
- C9 When the opportunity arises, the Camp Cove kiosk should be relocated to open the view corridor to the beach from the north-west end of Cliff Street.

### The waterfront

- C10 Front gardens are to be landscaped to soften the impact of buildings.
- C11 Boundary walls facing the beach are to be kept low and softened by landscaping behind (refer to Section 3.5.7 Fences and Walls).
- C12 Elements that evoke an early maritime character are to be retained, including traditional verandahed building forms, pitched and hipped corrugated steel or tiled roofs, chimneys and cultural plantings.
- C13 Unless shaded, no reflective materials are permitted, including glass balustrades.
- C14 New public or private jetties are not permitted along Camp Cove beachfront.

### Contributory items

Note: Heritage items as identified in Schedule 5 of Woollahra LEP 2014 are also contributory items. For the protection of heritage items refer to clause 5.10 of Woollahra LEP 2014.

Contributory items	
Off Camp Cove Beach	Tide Gauge Building 1925 small timber structure off NE end of Camp Cove Beach [SREP 23]
7 Victoria Street	Palms in beachfront garden, Norfolk Island pine in Victoria Street garden
15 Victoria Street	Edwardian semi-detached dwelling, palms in beachfront garden
17 Victoria Street	Edwardian semi-detached dwelling, coral tree in beachfront garden
19 Victoria Street	Palms and coral tree in beachfront garden
21 Victoria Street	Single storey Edwardian cottage, palms in beachfront garden
23 Victoria Street	Palms and Norfolk Island pine in beachfront garden
25 Victoria Street	Norfolk Island pines in beachfront garden

C15 Heritage items and contributory items are to be retained.

C16 Change to contributory items is limited to sympathetic alterations and additions consistent with the controls in Section C3.6.

### **Built form**

The following controls apply to new dwellings, or the main new building on the site. Separate controls apply to secondary structures such as new garages, carports, ancillary buildings and the like.

#### ***Building siting and alignment***

##### *Streetfront setbacks*

C17 The main part of the house is to follow the alignment of adjacent buildings and provide garden space between the Victoria Street wall and the house.

##### *Side boundary setbacks*

C18 All new buildings, including garages, are to be set back from side boundaries a minimum of 1.2m (1.5m on allotments greater than 15m in width) in order to retain the detached dwelling character of the precinct and allow for recovery of views to Camp Cove from Victoria Street (Figure 59).

##### *Front (waterfront) setbacks*

C19 Building setbacks from the waterfront are to relate to the alignment of adjacent significant houses provided that a garden space or lawn area is retained.

#### ***Building height***

C20 Buildings are to be two storeys maximum so as not to block views to the National Park from the Harbour and to retain a consistency of height when viewed from the Harbour.

#### ***Building form***

C21 Traditional forms are to be followed, i.e. simple rectilinear plan with pitched and hipped roofs and verandahs facing the waterfront (Figures 55 and 57).

C22 Flat or curved roofed buildings are not permitted.

#### ***Building character***

C23 New development is to respect the character of adjacent contributory items when viewed from the Harbour.

---

### ***Building materials and details***

C24 The following materials are appropriate for new buildings:

- a) Walls: weatherboards, sandstone, masonry or exposed, rendered or painted brickwork.
- b) Roof cladding: corrugated steel, slate, or tiled in unglazed terracotta or dark earth tones.

### **Landscaping and site coverage**

C25 The building footprint plus paved surfaces (patios, pathways, tennis courts and swimming pools) together are not to exceed 75% of the site area in order to provide 25% of the site area for landscaped area, including plantings.

C26 A mix of tiered planting, comprising small canopied trees, shrubs, herbaceous plants and ground covers, is preferred. Refer to Section 3.5.6 Landscaping and private open space.

### **Fences and walls**

#### *Camp Cove Beach*

C27 Wall heights facing Camp Cove Beach are to be a maximum 1.2m, or, where privacy from the beach is an issue, up to 1.8m maximum with 50% visual permeability above 1.2m. They should be softened by landscaping. Appropriate materials are sandstone or rendered/painted masonry to minimise its visual impact on the beach. Glazing or reflective materials are not to be used.

#### *Victoria Street*

C28 A fence or wall is to be built along the street front boundary.

C29 Fences or walls on the street front boundary are to be 1.8m in height and are to be designed in accordance with the criteria in Figures 59 and 60. Appropriate materials are sandstone or rendered/painted masonry.

C30 Fences or walls fronting Victoria Street are to have transparent end panels adjacent to the side boundary of each property. The transparent panels are to be at least as wide as the minimum required setbacks for buildings, i.e. 1.2m for allotments up to 15m wide and 1.5m for allotments over 15m wide (measured at street frontage).

C31 At least 50% of the street frontage width is to be landscaped behind the front fence wall.

C32 Garage, driveway doors and pedestrian gates on the street alignment are to be designed as an integral part of the street wall (Figures 59 and 60).

C33 The design and materials of front fences and walls are to be compatible with appropriately designed fences in the streetscape and the heritage context of the area. Unsympathetic fences, walls and gates are to be removed and replaced with fences of traditional height and appropriate to the architectural style of the building.

### *Cliff Street*

- C34 Fences and walls facing Cliff Street are to be a maximum 1.8m in height and to be constructed in traditional timber paling or, preferably rendered, masonry.
- C35 Side fences are to be traditional timber paling of a maximum 1.8m in height, reducing to 1.2m at the building alignment.

### **Car parking and access**

- C36 A maximum two car width single storey garage or carport structure may be built to the Victoria Street frontage provided that it is visually integrated with the street wall (Figure 60).
- C37 The total street frontage width of garage or carport structures is to be no greater than 50% of the street frontage width of the property.
- C38 Garages to the street frontage are to be 3.3m maximum in height. Any higher development is to be set back 1.5m from the street wall (Figure 61).

---

### C3.4.9 Precinct J: Pacific Street Waterfront

---

#### Character statement

Part of the 1855 subdivision, the precinct is bounded by Green Point Reserve, Pacific Street and Short Street, with water frontage to Watsons Bay (Figure 62). It contains substantial two storey waterfront houses, including a number of early buildings (Figure 63). Most lots retain their original, or early, configuration, with a number varying in width to take up the change in direction in the street.

Viewed from the Harbour against a backdrop of National Park vegetation visible above the roofs, buildings are relatively consistent in massing and height, with the exception of an intrusive residential flat building adjoining the Victoria Wharf Reserve.

Viewed from Pacific Street, a variety of pitched roofs appear above walls, fences and garages that create a built edge along the south side of Pacific Street. This is occasionally softened by pockets of landscaping whilst high, impermeable walls detract from the streetscape (Figure 64).

Many properties have large jetties extending out over rock shelves within the dry land area that forms part of the properties. These detract from the waterfront setting of the precinct (Figure 65).

The precinct contains only one area of open space, the Victoria Wharf Reserve. This is the site of the original wharf and is a viewing platform to the city and back along Victoria Street to the vegetated ridge on which HMAS Watson is located.

**FIGURE 62** Aerial view of the Precinct    **FIGURE 63** Pacific Street waterfront from the harbour



**FIGURE 64** Pacific Street Precinct at left, with high walls forming built edge to the street.



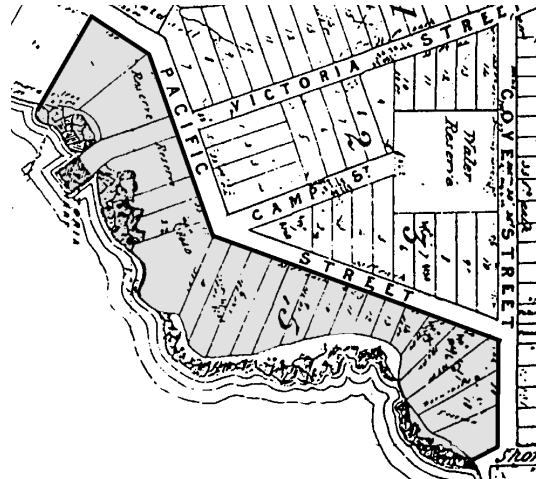
**FIGURE 65** Jetties within the Pacific Street Precinct, extending out over rockshelves



**FIGURE 66** View across the harbour to the city from Victoria Wharf Reserve



**FIGURE 67** Extract from 1855 'Town of Watsons Bay' subdivision plan



**FIGURE 68** Views to and from adjacent precincts and beyond

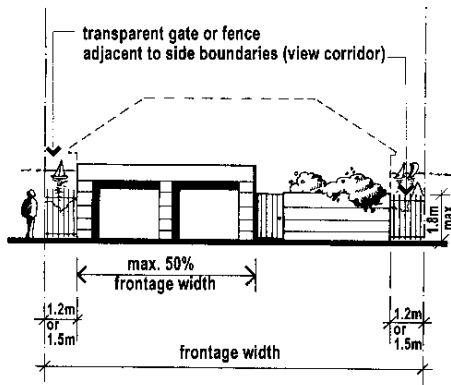


**FIGURE 69** Existing building heights along Pacific Street waterfront

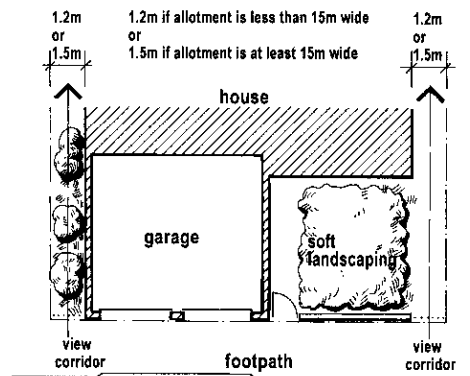




**FIGURE 70** Garages on street frontage



**FIGURE 71** Side boundary setbacks



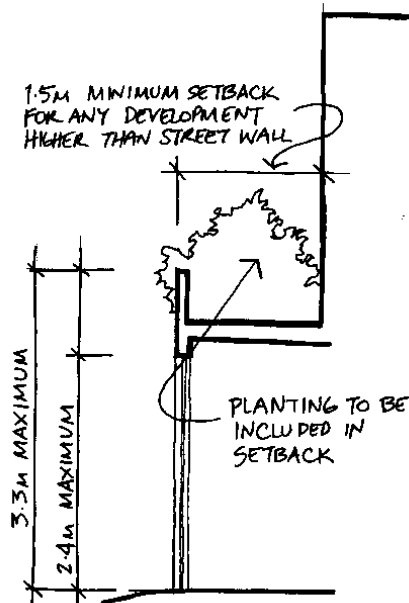
**FIGURE 72** Garages (at right) integrated with street wall



**FIGURE 73** Introduce permeability to walls and fences



**FIGURE 74** Maximum heights and setbacks for street walls



### PRECINCT CONTROLS

The precinct specific controls supplement the general controls for development in Section C3.5. If there is an inconsistency between the precinct controls and the general controls, the precinct controls take precedence.

#### Topography and vegetation

- C1 The existing landform of ridge, slope and rock platform down to the low water mark is to be maintained.
- C2 Excavation or filling of the rock platform is not permitted for any purpose, including the creation or construction of swimming pools or footings for jetties or boat ramps.
- C3 The intertidal zone within private property boundaries is not to be developed.
- C4 Mature historic plantings are to be retained within the grounds of early properties.
- C5 For new plantings, trees are to be selected that are appropriate in scale to available space.
- C6 The likely mature canopy size of proposed plantings is to be taken into account. Those that may obscure views to the HMAS Watson ridge and Sydney Harbour National Park from the adjacent Marine Parade North precinct, the Ferry Wharf and harbour ferries are not permitted.
- C7 Palms are not to comprise more than 25% of site plantings. Cocos palms are not to be used, though Howea, Bangalay and Cabbage Tree palms are permitted.

### Townscape

- C8 New site development is to be sited to achieve three visually distinct zones similar to most existing properties, that is:
- a rockshelf/front yard at the waterfront;
  - a building zone for detached houses with setbacks from side boundaries; and
  - a zone for landscaping adjacent to the street.
- C9 The pattern of relatively consistently scaled detached dwellings on separate lots is to be retained to respect the original subdivision layout (Figure 67).
- C10 The general scale established by existing buildings is to be maintained so that the backdrop of national park vegetation above roofs as viewed from the water will to be retained,.

### The waterfront

- C11 New jetties or any structures such as decking, boatsheds and cabanas, are not to be erected over the rock shelf within the inter tidal zone of private properties.
- C12 To improve the visual amenity of the Harbour, the rationalisation, and sharing between neighbours of existing long jetties is encouraged.
- C13 Construction of swimming pools on the rockshelf is not permitted.

### Views and vistas

- C14 View sharing with properties in adjacent precincts is to be retained. Examples are the views from the first floor of the 'Portuguese terraces' (Figure 66) and from the upper floors of buildings on the north side of Pacific Street.

### Contributory items

Note: Heritage items as identified in Schedule 5 of Woollahra LEP 2014 are also contributory items. For the protection of heritage items refer to clause 5.10 of the LEP.

Contributory items	
12 Pacific Street	Single storey Victorian weatherboard cottage with attic. Two storeys at waterfront.
14-14a Pacific Street	2 storey Victorian weatherboard house
16 Pacific Street	2 storey Victorian weatherboard house
18 Pacific Street	2 storey contemporary house
30 Pacific Street	2 storey Federation house
Victoria Street Reserve	Site of landing stage to early western jetty
2 Cove Street	Sandstone rock shelves

Contributory items	
4 Cove Street	Sandstone rock shelves
6 Cove Street	Sandstone rock shelves
2a Pacific Street	Sandstone rock shelves
2 Pacific Street	Sandstone rock shelves
4 Pacific Street	Sandstone rock shelves
6 Pacific Street	Sandstone rock shelves
8 Pacific Street	Sandstone rock shelves
10-12 Pacific Street	Sandstone rock shelves

C15 Heritage items and contributory items are to be retained.

C16 Change to the contributory items is to be limited to sympathetic alterations and additions consistent with the controls in Section C3.6.

**Built form**

The following controls apply to new dwellings, or the main new building on the site. Separate controls apply to secondary structures such as new garages, carports, ancillary buildings and the like.

***Building siting and alignment***

*Streetfront setbacks*

C17 The setback of the main part of the house is to correspond to the alignments of adjacent contributory items and allow for garden space between the street wall and the house.

*Side boundary setbacks*

C18 All buildings, including garages built to the street alignment, are to be set back from side boundaries 1.2m minimum for allotments up to 15m in width (measured at street frontage) and 1.5m for allotments greater than 15m in width. This will retain the detached dwelling character of the precinct and to provide for view corridors to the Harbour along sides of buildings (see Figure 70).

*Rear (waterfront) setbacks*

C19 Building setbacks from the waterfront are to match the alignment of adjacent significant houses and provide garden space or lawn area between the rockshelf and the house.

***Building height***

C20 Buildings are limited to two storeys so as not to block views to the national park from the harbour and to retain a consistency of height when viewed from the Harbour.

---

**Building form**

- C21 Established building forms are to be followed, i.e. simple rectilinear plan forms with pitched roofs.
- C22 Roof ridgelines are to be parallel to side boundaries in order to minimise the visual impact of roofs on views and when viewed from the street and the waterfront.
- C23 No flat-roofed buildings or reverse skillions are permitted.

**Building character**

- C24 The architectural style of new buildings is not to stand out in marked contrast to the established character of the area.
- C25 The design of new buildings is to respect the character of adjacent contributory items when viewed from the harbour.

**Building materials and details**

- C26 The following materials are appropriate for new buildings:
  - a) Walls: face, rendered or painted brickwork or masonry.
  - b) Roof cladding: slate, or tiled in unglazed terracotta or dark earth tones.

**Landscaping and site coverage**

- C27 The building footprint plus paved surfaces (patios, pathways, tennis courts) and swimming pools together are not to exceed 75% of the site area in order to provide 25% of the site area for landscaped area, including plantings.
- C28 A mix of tiered planting, comprising small canopied trees, shrubs, herbaceous plants and ground covers, is to be achieved. Refer to Section 3.5.6 Landscaping and private open space.

**Fences and walls**

- C29 A fence or wall is to be built along the Pacific Street front boundary.
- C30 At least 50% of the street frontage width is to be landscaped behind the front fence/wall.
- C31 Fences or walls on the street front boundary are to be 1.8m maximum in height and are to be designed in accordance with criteria in Figures 70 and 71. Acceptable materials are sandstone, brick or masonry, rendered and painted.
- C32 Fences or walls fronting Pacific Street are to have transparent end panels adjacent to the side boundary of each property. The transparent panels are to be at least as wide as the minimum required setbacks for buildings, i.e. 1.2m for allotments up to 15m wide and 1.5m for allotments over 15m wide (measured at street frontage).

- C33 Garage, driveway doors and pedestrian gates on the street alignment are to be designed as an integral part of the street wall but with visual permeability adjacent to the side boundaries (see Figures 70 and 71).
- C34 Fences or seawalls to the harbour are to be of sandstone, 1.2m maximum in height above existing ground level.
- C35 Fences facing Green (Laings) Point Reserve are to be 1.8m maximum traditional timber paling.
- C36 Fences on the northeast side of Victoria Wharf Reserve are to be 1.8m high, either of timber palings, rendered masonry or contemporary vertical steel with brick base and softened by planting. Fences on the east side are to be kept low (1.2m maximum) in order to retain existing views to the harbour and constructed in masonry in keeping with building to which it relates).

#### **Car parking and access**

- C37 A maximum two car width single storey garage or carport structure may be built to the Pacific Street frontage provided that it is visually integrated with the street wall (Figures 70 and 71).
- C38 All new buildings, including garages, are to be set back from side boundaries a minimum of 1.2m (1.5m on allotments greater than 15m in width) in order to retain the detached dwelling character of the precinct and to allow for the recovery of views to the harbour from Pacific Street (Figure 68).
- C39 Garages on the street frontage are to be 3.3m maximum in height. Any higher development is to be set back 1.5m from the street wall (Figure 74).

---

### C3.4.10 Precinct K: Camp Cove Village

---

#### Character statement

Part of the 1855 The Town of Watsons Bay subdivision, the precinct is bounded by Victoria Street, Cliff Street, Short Street and Pacific Street. This part of the early subdivision has mostly retained its historic townscape character, with low-scaled one and two storey detached houses sited on relatively small allotments. Camp Cove Reserve, originally a lagoon behind the sand dunes, is at its core.

Houses are generally built close to the street, with only small setbacks from front and side boundaries. There are limited small areas of garden space at the front behind low fences and within yards at the rear. Trees in the rear yards form a backdrop to the houses when viewed from the streets.

Buildings and groups of buildings that contribute to the character of the precinct date from two key periods: 1850s-1870s and 1910s-1930s. The precinct includes most of the timber weatherboard cottages in Watsons Bay, which is the largest concentration in Woollahra Municipality. The key contributory groups are:

#### *Victoria Street*

- ▶ Surviving single storey weatherboard and masonry cottages, and a two storey c1930s house on a larger allotment, with Inter-War flat building at corner of Pacific Street.

#### *Pacific Street*

- ▶ Small-scaled one and two storey brick and weatherboard cottages behind low fences and small front gardens. These soften built edge and create more uniform streetscape character than on the opposite side.

#### *Cliff Street*

- ▶ Variety of housing dating from 19th century to early-mid 20th century, including single storey brick and early weatherboard cottages with pitched roofs. Many have very small to negligible setbacks from street with low fences that contribute to the historic townscape.

#### *Cove Street*

- ▶ One and two storey cottages on the north-east side, with pitched roofs, set back from the street frontage behind a variety of fences, some with small front gardens.
- ▶ Significant group of early single storey cottages with verandahs aligned with street frontage.
- ▶ Larger, two storey buildings at south end, including a group of four two storey terraces (Portuguese terraces) and a two storey weatherboard house, built close to the street frontage.

**Short Street**

- The single storey cottage at the intersection of Short Street and Military Road.

**Camp Street**

- The laneway character with rear yards of houses set behind fences and carports.

The contrast between the modest cottages of the precinct and the large waterfront mansions of the adjoining precincts creates two visually distinct streetscape components along Victoria Street and Pacific Street. The streetscape of Cliff Street provides further contrast between low-scaled housing on one side and the rising ridge of the national park opposite. These visual distinctions reinforce the historic townscape character of the precinct.

Public views to the harbour from within the precinct from the end of Victoria Street, near the Victoria Wharf Reserve. Camp Cove Reserve provides an internal focus, with views into it from Cove Street, Pacific Street and Camp Street. There are broader vistas to HMAS Watson, and the distant spire of Our Lady Star of the Sea.

**FIGURE 75** Aerial view of the precinct



**FIGURE 76** Victoria Street



**FIGURE 77** Pacific Street



**FIGURE 78** Cliff Street





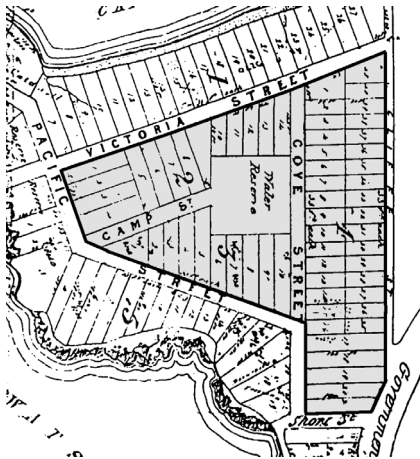
**FIGURE 79** Stone and weatherboard cottages on Cove Street



**FIGURE 80** Camp Street from Reserve



**FIGURE 81** Extract from 1855 'Town of Watsons Bay' subdivision plan



**FIGURE 82** Intersection of Short Street and Cliff Street



**FIGURE 83** View along Camp Street into Camp Cove Reserve



**FIGURE 84** Portuguese Terraces in Cove Street



**FIGURE 85** Weatherboard and stone cottages on Cove Street



**FIGURE 86** Weatherboard cottage on Cliff Street



**FIGURE 87** Appropriate fencing along Victoria Street



## PRECINCT CONTROLS

The precinct specific controls supplement the general controls for development in Section C3.5. If there is an inconsistency between the precinct controls and the general controls, the precinct controls take precedence.

### Topography and vegetation

- C1 The streetscape qualities of Cove Street are to be retained, enhanced by landscaped open space of Camp Cove Reserve and variable street trees including bottlebrushes, robinias, silky oaks and eucalyptus.
- C2 Remnant sandstone kerbing and guttering are to be retained, including the section in Victoria Street (opposite the end of Cove Street, and outside No 2 Pacific Street, adjoining Short Street).
- C3 The use of mainly subtropical shrubs (hibiscus, frangipani, bougainvillea, etc.) is encouraged in front gardens.

### Townscape

- C4 The pattern of low-scaled detached dwellings and groups of dwellings on separate allotments is to be retained in order to respect the 1855 subdivision layout (Figure 81).
- C5 New development is to be sited to achieve three visually distinct zones similar to most properties, that is:
- small landscaped setback;
  - building zone of one and two storey detached houses with setbacks from side boundaries; and
  - landscaped rear yards.
- C6 New development is to retain the contrasts between the character established by low-scaled one and two storey 19th century to early-mid 20th century housing behind low fences and small front gardens and the high-walled mansions on the opposite sides of Victoria Street and Pacific Street.
- C7 The ‘gateway’ characteristics at the intersection of Short Street and Cliff Street are to be retained, including the distinctive single storey cottage at the corner, enhanced by a group of palms and the natural edge of Cliff Street (Figure 82).
- C8 The laneway character of Camp Street is to be retained, with rear yards of houses set behind high paling fences on both sides of street. Consistency of fencing types is to be achieved in order to foster visual coherence.
- C9 The sense of enclosure and natural edge on Cliff Street is to be retained, formed by coral trees, brush boxes and melaleucas from the edge of the Sydney Harbour National Park.
- C10 High walls and garages on the street frontage are not to be permitted as they would detract from the streetscape appearance of houses and the historic townscape character.

### Views and vistas

- C11 Views to the harbour and Inner South Head from Short Street and from Victoria Wharf Reserve are to be retained.
- C12 Vistas are to be retained to Green (Laings) Point Reserve, HMAS Watson, Camp Cove Reserve and the distant church spire.
- C13 Views into Camp Cove Reserve from Cove Street and Camp Street are to be retained.

### Contributory items

Note: Heritage items as identified in Schedule 5 of Woollahra LEP 2014 are also contributory items. For the protection of heritage items refer to clause 5.10 of the LEP.

#### Contributory items

18 Cliff Street	Single storey Edwardian cottage
-----------------	---------------------------------

Contributory items	
22 Cliff Street	Single storey Edwardian weatherboard cottage
23 Cliff Street	Single storey 1920s weatherboard cottage
28 Cliff Street	Single storey Edwardian brick cottage with second storey addition
30 Cliff Street	Single storey 1920s weatherboard cottage
3 Cove Street	2 storey Victorian filigree styled terrace
5 Cove Street	2 storey Victorian filigree styled terrace
7 Cove Street	2 storey Victorian filigree styled terrace
9 Cove Street	2 storey Victorian filigree styled terrace
21 Cove Street	Single storey Edwardian weatherboard cottage
23 Cove Street	Single storey 1920s cottage
25 Cove Street	Single storey Edwardian weatherboard cottage
27 Cove Street	Single storey Edwardian timber cottage
29 Cove Street	Single storey Edwardian weatherboard cottage
41 Cove Street	Single storey 1920s weatherboard cottage
43 Cove Street	Single storey Edwardian weatherboard cottage
45 Cove Street	Single storey Edwardian weatherboard cottage
1 Pacific Street	Single storey Victorian weatherboard cottage with 3 storey extension
3 Pacific Street	Single storey 1920s cottage
5 Pacific Street	Single storey Victorian weatherboard cottage
9 Pacific Street	2 storey Edwardian weatherboard cottage
11 Pacific Street	Single storey 1920s weatherboard cottage
13 Pacific Street	Single storey Edwardian weatherboard cottage
15 Pacific Street	Single storey Victorian weatherboard cottage
17 Pacific Street	Single storey Edwardian weatherboard cottage with attic
21 Pacific Street	Single storey Victorian timber cottage
4 Victoria Street	Single storey Edwardian weatherboard cottage
6 Victoria Street	Single storey Victorian weatherboard cottage
14 Victoria Street	Single storey Victorian weatherboard cottage
16 Victoria Street	Single storey Edwardian weatherboard cottage
18 Victoria Street	Single storey 1920s weatherboard cottage
20 Victoria Street	Single storey Inter-War fibro house

Contributory items	
22-24 Victoria Street	2 storey Inter-War flat building
Camp Cove Reserve	2 Moreton Bay Figs, Camphor laurel, Kaffir Plum, Eucalypts, Podocarpus, Stenocarpus

C14 Heritage items and contributory items are to be retained.

C15 Change to the contributory items is limited to sympathetic alterations and additions consistent with the controls in Section C3.6.

### Built form

The following controls apply to new dwellings, or the main new building on the site. Separate controls apply to secondary structures such as new garages, carports, ancillary buildings and the like.

#### *Building siting and alignment*

##### *Streetfront setbacks*

C16 Setbacks of new houses are to correspond to the alignment of adjacent contributory items and to provide garden space between the street and the house.

C17 Garages or carports are to be setback behind the building line.

C18 A maximum of one garage door is to be visible from the street frontage.

##### *Side boundary setbacks*

C19 All new buildings and structures, including any carport or garage, are to be set back from the side boundaries a minimum of 1.2m to retain the detached dwelling character of the precinct and respect the historic development pattern.

##### *Rear setbacks*

C20 Building setbacks are to relate to the alignment of adjacent houses provided that a rear yard space is retained.

#### *Building height*

C21 The height of new buildings is to be consistent with the height of neighbouring contributory items (generally a single storey plus attic).

#### *Building form*

C22 Established building forms are to be followed, i.e. simple rectilinear plan with traditional pitched roofs and verandahs facing the street.

C23 To relate to traditional roof forms, flat-roofed buildings are not permitted.

### ***Building character***

C24 The style of new buildings is to respect the character of the significant 19th to mid-20th century housing.

### ***Building materials and details***

C25 The following materials are appropriate for new buildings:

- a) Walls: weatherboards, or exposed, rendered or painted brickwork or masonry.
- b) Roof cladding: corrugated steel, slate, or tiled in unglazed terracotta or dark earth tones.

### **Landscaping and site coverage**

C26 The building footprint plus paved surfaces (patios, pathways, tennis courts) and swimming pools together are not to exceed 75% of the site area in order to provide 25% of the site area for landscaped area, including plantings.

C27 For landscape planting details refer to Section 3.5.6 Landscaping and private open space.

### **Fences and walls**

#### ***Front fences***

C28 With the exception of Camp Street, fences are to be a maximum of 1.2m.

C29 Materials: sandstone, rendered and painted masonry, timber post and rail with chain wire inserts and timber pickets in keeping with the period of the house to which they relate.

C30 Low front fences to early cottages should be reconstructed where replaced by unsympathetic higher walls (e.g. in Victoria Street and Cliff Street).

#### ***Side and rear fences (including Camp Street)***

C31 Side and rear fences, including fences on Camp Street, backing onto Camp Cove Reserve are to be 1.8m maximum in height and of traditional timber paling.

Note: Appropriate front fencing types are illustrated in Section 3.5.7 Fences and walls.

### **Car parking and access**

C32 With the exception of those on Camp Street, garages or carports are not to be built to street frontage and are to be set back behind the main building. Only one vehicular access driveway is permitted at the street frontage.

### **Inter-War flat buildings or multi dwelling housing**

For Inter-War flat buildings, refer to Clause 3.6 Contributory items: additional built form controls.

---

### C3.4.11 Precinct L: Salisbury Street / Hopetoun Avenue

---

#### Character statement

This precinct is bounded by Robertson Place, Old South Head Road and the heritage conservation area boundary. Parts of Hopetoun Avenue and Salisbury Street cross through the precinct (Figure 88).

The buildings fronting the south side of Robertson Place include a group of three contributory c1920s bungalows and a single detached house at the Hopetoun Avenue intersection. The group is consistent in the scale, form and alignment of the buildings, which are set back from the street behind low original fences with small gardens. A garage to the street frontage disturbs the consistency of the group.

The Salisbury Street streetscape includes the historic road alignment that marks the boundary of an original land grant and the Beaconsfield Estate owned by John Robertson. The western end of the street, backed by a group of mainly cultural plantings including banana palms, mature phoenix palms, melaleucas and immature Norfolk Island pines, appears to terminate on a cliff above the waterfront, however, it makes a U-turn at this point, leading down to housing at a lower level. Cultural plantings within the south western properties include Port Jackson Figs. The street trees in the upper section of the street include palms, a water gum, a Norfolk Island pine and a melaleuca.

Significant views west to Sydney Harbour are largely retained, being partly obscured by the cultural plantings (Figure 89). There are also views from the harbour to the Church Group beyond.

The built form on the southern side of Salisbury Street includes three contributory single storey Victorian period houses and early 20th century housing. The north side, west of Hopetoun Avenue, includes a contemporary house with a curved roof overlooking the water and 1930s flats below the retaining wall. Variable fencing types exist in this precinct, including face and rendered brick and iron palisade. A large sandstone retaining wall is a significant feature of the west end of the street, forming the U-shaped cul-de-sac.

Hopetoun Avenue was formed during the 1920s, falling towards Robertson Place. It maintains significant vistas to Sydney Harbour. Few buildings on Hopetoun Avenue contribute to the significance of the Watsons Bay Heritage Conservation Area, with the exception of a heritage item, 'Bay Cottage', at 308 Old South Head Road. The remaining buildings consist of two storey detached houses with pitched roofs, fenced front gardens and later development that extends to the land grant boundary that terminates the conservation area at Salisbury Street. These residential properties provide a variety of private garden treatments, plantings and fencing types including brick, timber palings, picket, wire mesh and sandstone. A dominant significant sandstone boundary retaining wall extends along the eastern side of the street.

**FIGURE 88** Aerial of the precinct



**FIGURE 89** The west end of Salisbury Street with views to the harbour



**FIGURE 90**  
Contributory item on east side of Hopetoun Avenue



**FIGURE 91**  
Significant sandstone retaining wall



**FIGURE 92**  
View along Salisbury Street to the Church Group



**FIGURE 93**  
Sandstone block retaining wall with traditional timber paling fence above on the east side of Hopetoun Avenue





**FIGURE 94** Composite wall containing sandstone and face brick on Salisbury Street



## PRECINCT CONTROLS

The precinct specific controls supplement the general controls for development in Section C3.5. If there is an inconsistency between the precinct controls and the general controls, the precinct controls take precedence.

### Topography and vegetation

- C1 Existing height relationships are to be maintained between the higher properties (located between Old South Head Road and Hopetoun Avenue) and the lower properties (located below Hopetoun Avenue).

### Townscape

- C2 The existing subdivision patterns of deep allotments that front the public roads are to be retained. Battle-axe shaped lots are not permitted so as to retain the visual balance of the green spaces in both front and rear yards.

### Views and vistas

- C3 Existing views to the harbour are to be retained over roofs from the upper levels of the precinct, including those from Old South Head Road.
- C4 Roofs are not to be cluttered by intrusive structures/services in order not to detract from views to and from the upper levels of the precinct.
- C5 The plantings that currently block views west along Salisbury Street to the harbour should be removed. New or replacement plantings (on the slope down to the waterfront) are to reinstate the view corridor.

### Contributory items

Note: Heritage items as identified in Schedule 5 of Woollahra LEP 2014 are also contributory items. Refer to clause 5.10 of the LEP for heritage conservation controls.

Contributory items	
Rear 308 Old South Head Road	2 storey Edwardian house
Within Salisbury Street road reserve	Sandstone retaining wall to split roadway with rockery and concrete stairs
Within Hopetoun Avenue East road reserve	Sandstone walls
2 Robertson Place	Single storey 1920s cottage
4 Robertson Place	Single storey 1920s cottage
6 Robertson Place	Single storey 1920s cottage
2 Salisbury Street	Single storey Victorian Gothic styled cottage
4 Salisbury Street	Single storey Victorian weatherboard cottage
8 Salisbury Street	Single storey Victorian sandstone cottage
10 Salisbury Street	Port Jackson fig
1 Salisbury Street	Single storey Edwardian semi-detached dwelling
3 Salisbury Street	Single storey Edwardian semi-detached dwelling
7 Salisbury Street	2 storey Inter-War flat building
11 Salisbury Street	2 storey Inter-War flat building

C6 Heritage items and contributory items are to be retained.

C7 Change to contributory items is limited to sympathetic alterations and additions consistent with the controls in Section C3.6.

### Built form

The following controls apply to new dwellings, or the main new building on the site. Separate controls apply to secondary structures such as new garages, carports, ancillary buildings and the like.

#### *Building siting and alignment*

C8 The existing setback patterns, particularly regular or transitional, are to be maintained.

C9 Where an irregular pattern exists, new development is to be set back to correspond to the alignment of contributory items and provide for landscaped area in front yards behind fences or walls.

- 
- C10 The alignment of new buildings is to be parallel with the street frontage, not skewed, to maintain existing streetscape patterns.
- C11 Building setbacks from the rear are to correspond to the setback pattern of adjacent buildings and maintain the amenity of neighbouring residential property.

#### ***Building height***

- C12 Building heights are to respect the natural landform and topography of the precinct. Existing views from the upper levels of the precinct are not to be obstructed by development below.

#### ***Building form***

- C13 The mass and form of new buildings is to respect adjacent contributory items.
- C14 Rectilinear plans with traditional pitched roof forms are to be used to relate to the established character of the area.

#### ***Building materials and details***

- C15 The following materials are appropriate for new buildings:
- Walls: exposed brick or rendered/ painted brickwork or masonry.
  - Pitched roofs for dwellings: slate, tiled in unglazed terracotta or dark earth tones, or slate-grey corrugated iron.

#### **Landscaping and site coverage**

- C16 The building footprint plus paved surfaces (patios, pathways, tennis courts) and swimming pools together are not to exceed 70% of the site area in order to provide 30% of the site area for landscaped area, including plantings.
- C17 For landscape planting details refer to Section 3.5.6 Landscaping and private open space.

#### **Fences and walls**

- C18 Front fences are to be 1.2m maximum in height. Materials are to be in keeping with the building to which they relate, including rendered and painted masonry, brick, palisade or wooden pickets.
- C19 Side and rear fences are to be 1.8m maximum traditional timber paling fences or, preferably rendered, masonry walls, stepping down in height to 1.2m at the front boundary line.
- C20 Garages are not to be built to the street alignment, but are to be set back behind the building alignment or integrated with the building.

### **Inter-War flat buildings or multi dwelling housing**

For Inter-War flat buildings, refer to Clause 3.6 Contributory items: additional built form controls.

### C3.4.12 Precinct M: Robertson Park

#### Character statement

Robertson Park is a significant historic item in the landscape and townscape of the Watsons Bay Heritage Conservation Area. The park was created in 1909 from the grounds of the mansion “Clovelly” that had been constructed on this site in the late 1820s. Its last owner was Sir John Robertson, a former Premier of NSW.

Robertson Park is the major green open space in the centre of the area. It is a natural wide amphitheatre that slopes towards the harbour, linking the open space of the waterfront to The Gap. It retains extensive views to the harbour, Gap Reserve and across Robertson Place (Figure 95).

The Park has a formal layout, containing significant cultural plantings including fig trees and Norfolk Island Pines which are remnant plantings from the grounds of ‘Clovelly’. In particular, the 19th century Moreton Bay fig trees create a broad canopy over the adjacent promenade and are a significant feature of views to Robertson Park from the water. Coastal Banksias have also been planted in the park and Port Jackson figs along its southern perimeter. The edge of the park is well defined by roads, the harbour and its cultural plantings.

The section of Marine Parade that adjoins Robertson Park includes the ferry terminal that is the arrival point to Watsons Bay by boat. The waterfront promenade along the sandy beach is well defined by a sandstone wall. Each end of the promenade is defined by wharves and marine structures. A significant view corridor exists from the wharf and promenade across Robertson Park and Robertson Place to The Gap and Gap Park, with vistas to the spires of the local churches and the lighthouse.

**FIGURE 95** Aerial view of the precinct



**FIGURE 96** View across Robertson Park to Robertson Place and the harbour



**FIGURE 97** Robertson Park from the Gap



**FIGURE 98** Robertson Park



**FIGURE 99**

Formal layout of Robertson Park including cultural plantings, showing avenue of recently-removed phoenix palms



### PRECINCT SPECIFIC GUIDELINES

The precinct specific guidelines supplement the general controls for development in Section C3.5. If there is an inconsistency between these precinct guidelines and the general controls, the guidelines take precedence.

This land is in public ownership and is managed through a plan of management. It is strongly recommended that the plan of management includes or is informed by the following management policies:

- G1 Mature historic plantings are to be retained. If new plantings are proposed, species are to be selected that are appropriate in scale, canopy size and character to those existing in the cultural landscape. New plantings are not to obscure existing views and vistas. Refer to Section 3.5.6 Landscaping and private open space.
- G2 Existing extensive public views are to be retained between the park and the harbour, The Gap and Robertson Place.
- G3 The public access is to be retained from the park to the waterfront.

- 
- G4 No new development or alterations and additions to existing buildings except where required by the management plan and consistent with the policies in the plan for siting, orientation, height limits and design.
- G5 New structures are to follow established forms, i.e. simple rectilinear plan buildings with pitched roofs of a small scale.
- G6 Any required new public amenity structures, including shade structures, are to be sited so as to avoid the removal of cultural plantings, retain the formal layout of the park and not obstruct existing view corridors between the harbour and the Gap.
- G7 New fences and walls within Robertson Park are to be of a low, 1.2m maximum height in order to retain the open character of the park and constructed of either sandstone or grey-coloured concrete. Fencing around playground equipment is to be open and transparent.
- G8 The existing public access, including disabled access, is to be retained to Robertson Park.
- G9 Any new paths throughout the precinct are to be constructed using recessive colours and finishes.
- G10 The management plan should incorporate a cohesive approach for the public areas along Marine Parade in terms of paving, street furniture, lighting, signage and the like.
- G11 The public domain controls in Section C3.7 of this chapter apply to the publicly accessible areas of the site.

### Contributory items

Note: Heritage items as identified in Schedule 5 of Woollahra LEP 2014 are also contributory items. Refer to clause 5.10 of the LEP for heritage conservation controls.

#### Contributory items

Robertson Park	Three Moreton Bay figs on western edge, Port Jackson Figs on southern edge, avenue planting to be replaced, Norfolk Island Pines in SE and NE corners associated with former marine villa “Clovelly”, archaeological relics associated with “Clovelly”
----------------	--

---

### C3.4.13 Precinct N: Robertson Place

---

#### Character statement

Robertson Place is a small park located adjacent to Robertson Park. A close visual association is maintained between these two green spaces within the Watsons Bay Heritage Conservation Area (Figure 100).

Robertson Place provides the landscape setting and curtilage to Dunbar House, which was constructed from 1828 and converted to a hotel in 1854. The park slopes like an amphitheatre toward the harbour, with extensive views to the waterfront and Robertson Park. A sandstone obelisk marks the beginning of the 1803 road to Sydney.

**FIGURE 100** Aerial view of the precinct



**FIGURE 101** Robertson Place from the harbour



**FIGURE 102** Dunbar House within an established cultural setting





## PRECINCT SPECIFIC GUIDELINES

The precinct specific guidelines supplement the general controls for development in Section C3.5. If there is an inconsistency between these precinct guidelines and the general controls, the guidelines take precedence.

This land is in public ownership and is managed through a plan of management and conservation management plan. It is strongly recommended that these plans include or are informed by the following management policies:

- G1 Mature historic plantings are to be retained, including the fig trees. Removed cultural plantings are to be reinstated. If new plantings are proposed, species are to be selected that are appropriate in scale, canopy size and character to those existing in the cultural landscape. New plantings are not to obscure existing views and vistas. Refer to Section 3.5.6 Landscaping and private open space.
- G2 The existing extensive public views are to be retained between Robertson Place, Robertson Park and the waterfront.
- G3 The existing public access, including disabled access, from Robertson Place to the waterfront is to be retained.
- G4 In order to retain the curtilage and setting of Dunbar House, new development and alterations and additions to Dunbar House will only be permitted where consistent with an adopted conservation management plan and its guidelines for siting, orientation, height limits and design. New structures are to follow established forms, i.e. simple rectilinear buildings with pitched roofs of a small scale. New buildings are not to be flat roofed.
- G5 No additional fencing is to be constructed except where consistent with the guidelines contained in an adopted conservation management plan. New fences and walls within Robertson Place are to be of a low, 1.2m maximum height and be constructed of either sandstone or grey-coloured concrete.
- G6 No additional car parking or vehicular access is permitted.
- G7 Any new paths throughout the precinct are to be constructed using recessive colours and finishes.
- G8 The conservation management plan is to incorporate a cohesive approach for the public areas along Marine Parade (in terms of paving, street furniture, lighting, signage and the like).
- G9 The public domain provisions in Section C3.7 of this chapter apply to the publicly accessible areas of the precinct.

### Contributory items

Note: Heritage items as identified in Schedule 5 of Woollahra LEP 2014 are also contributory items. Refer to clause 5.10 of the LEP for heritage conservation controls.

#### Contributory items

Within Robertson Park	2 Port Jackson Figs, avenue of Phoenix palms parallel to the Promenade
-----------------------	--

---

### C3.4.14 Precinct O: Gibsons Beach Waterfront and Marine Parade South

---

#### Character statement

This precinct consists of properties with a frontage to Marine Parade, south of Robertson Place.

The waterfront promenade is contained visually by a single storey yacht club and the Watsons Bay public baths at the north end and the two storey Pilot Station at the south end (Figure 106 and 107). A flight of steps leads up to Salisbury Road (Figure 109).

Marine Parade continues south as a walkway to Gibsons Beach, a small beach semi-detached dwelling enclosed by the Pilot Station to the north and the natural landform to the south (Figure 108). A narrow park along the promenade widens at the southern end to form Gibsons Beach Reserve with an open landscape character. The beach and the park curtilage are protected by a sandstone headland, as well as rock benches and sandstone walls to the properties above. A small creek enters the beach from the southwest. Boat sheds and jetties extend out to the point. The mixed public pathway/private driveway allows access around the small reserve behind the beach to Hopetoun Avenue.

The northern part of the precinct contains a variety of built and landscape elements that contribute to its character. These include the distinctive yacht club and Pilot Station buildings with jetties on the western side and the Inter-War period Tea Gardens, formerly the facilities for the Watsons Bay Pool at the north end (Figure 111).

Housing includes single storey detached and semi-detached dwellings (c1920s–1930s) with pitched roofs, many of which have been altered (Figure 112). Front gardens are generally set behind low walls and are open in character, elevated above the promenade toward the south end. The two to three storey dwellings above in the southern section (some with remnant cultural plantings) are barely visible from the beach.

Street tree plantings of Casuarinas and a topped Norfolk Island pine opposite Tea Gardens enhance the waterfront setting. The tree and shrub plantings at the west end of Salisbury Street are not of heritage significance and obstruct views to the Harbour.

Properties have harbour views from the water; there are views to the spire of Our Lady Star of the Sea church and cultural plantings on the ridgeline.

Prominent garages on or close to the street frontage detract from the promenade and views from the waterfront. The visual impact of a contemporary dwelling with an uncharacteristic curved roof is partially mitigated by its relatively low scale and sympathetic landscaping when compared with larger buildings behind.

**FIGURE 103**  
Aerial view of the precinct



**FIGURE 104**  
Marine Parade streetscape



**FIGURE 105**  
Marine Parade South from the pilot station



**FIGURE 106**  
Yacht club at north end



**FIGURE 107**  
Pilot Station at the south end of Marine Parade



**FIGURE 108**  
North end of Gibsons Beach Reserve



**FIGURE 109**

Open space and steps leading up to Salisbury Street



**FIGURE 110**

Gibsons Beach from the promenade



**FIGURE 111**

'Tea Gardens'



**FIGURE 112**

Marine Parade South from the harbour



**FIGURE 113**

Views to the harbour from Gibsons Beach



---

## PRECINCT CONTROLS

The precinct specific controls supplement the general controls for development in Section C3.5. If there is an inconsistency between the precinct controls and the general controls, the precinct controls take precedence.

### Topography and vegetation

- C1 New street and promenade planting is to be selected to provide amenity (shade, softening of hard built areas, glare reduction) for pedestrians using the marine promenade, permit views out to the harbour and create opportunities for public views both to Watsons Bay from the harbour and to the harbour from the top of Salisbury Street.
- C2 Additional street or promenade trees may be introduced provided that they are appropriate for waterfront microclimatic conditions, are open-branched with relatively thin and permeable foliage, but with sufficient canopy to provide some shade – such as casuarinas. Araucarias, figs and most palms are unsuitable, although Canary Island palms may be considered.
- C3 Tree and shrub plantings at west end of Salisbury Street should be replaced with species that do not exceed 5m in height, have single trunks and open branching habits. These are to be placed to frame, not obstruct views.
- C4 Plantings down the steep slope between the west end, or ‘elbow’, of Salisbury Street and the waterfront should be selected to consolidate the slope while not obstructing the view. Species should be similar to the park-like plantings around.

### Townscape

- C5 The regular pattern of detached buildings on separate allotments south of Tea Gardens is to be retained in order to respect the established form and provide for public views between buildings.

### The waterfront

- C6 Views of houses, roofs and gardens from the promenade and Harbour are to be retained, unobstructed by high fences.

### Views and vistas

- C7 View sharing from private properties is to be retained within the precinct and with overlooking properties in adjacent precincts.
- C8 Vistas are to be retained to Our Lady Star of the Sea church spire and cultural plantings as viewed from the harbour.
- C9 Existing maritime structures, such as the yacht club and pilot station, are not to be increased in height or bulk so that views to the harbour can be enjoyed.

### Contributory items

Note: Heritage items as identified in Schedule 5 of Woollahra LEP 2014 are also contributory items. Refer to clause 5.10 of the LEP for heritage conservation controls.

Contributory items	
Marine Parade	<b>Watsons Bay Pool (Baths) [SREP Sydney Harbour]</b> A concrete arched pool structure with timber balustrades
Marine Parade	<b>Watsons Bay Ferry Pier [SREP Sydney Harbour]</b> A timber and concrete wharf structure
2 Marine Parade	Single storey Edwardian cottage with second storey addition
3 Marine Parade	Single storey Edwardian cottage
5 Marine Parade	2 storey house over garages
6 Marine Parade	Single storey semi -detached dwelling
7 Marine Parade	Single storey semi -detached dwelling
8 Marine Parade	Single storey Spanish Mission styled restaurant ‘Tea gardens’
Salisbury Street	Pilot station [SREP Sydney Harbour]
12 Salisbury Road	Kaffir Plum, Date palm, sandstone retaining wall to reserve
Within Gibsons Beach Reserve	Coral trees and phoenix palms Exposed rockfaces adjoining the promenade

C10 Heritage items and contributory items are to be retained.

C11 Change to contributory items is limited to sympathetic alterations and additions consistent with the controls in Section C3.6.

### Built form

The following controls apply to new dwellings, or the main new building on the site. Separate controls apply to secondary structures such as new garages, carports, ancillary buildings and the like.

#### ***Building siting and alignment***

##### *Front (waterfront) setbacks*

C12 All buildings are to be sited to provide a landscaped setback from Marine Parade to provide for a garden space in front. The setback and alignment are to be related to adjacent buildings and the skewed alignment pattern.

---

### *Side setbacks*

- C13 All buildings are to be a minimum of be set back from side boundaries by 1.5m to retain the detached building character of the precinct and provide for public views between buildings.

### *Rear setbacks*

- C14 Rear setbacks are to be similar to adjacent setbacks in order to maintain the amenity of neighbouring residential property.

### *Building height*

- C15 Buildings are to comply with the maximum statutory height control in Woollahra LEP 2014 and are to be a maximum of two storeys in height, with roofs pitched to match traditional forms.
- C16 No increase is permitted in the height of marine structures, such as the yacht club (Figure 106) and pilot station (Figure 107), at each end of the precinct.

### *Building form*

- C17 Established building forms are to be used, i.e. simple rectilinear plan with pitched roofs.
- C18 Buildings should not be flat-roofed or reverse skillion, in order to relate to traditional roof forms when viewed from the water.
- C19 Ridgelines of roofs are to be parallel to the side boundaries in order to minimise the visual impact of roofs on views when viewed from Marine Parade and the waterfront.

### *Building character*

- C20 The architectural treatment of new buildings is not to stand out in marked contrast to existing contributory items in the area.

### *Building materials and details*

- C21 The following materials are appropriate for new buildings:
- a) Walls: preferably face brickwork or rendered/painted brickwork or masonry.
  - b) Roofs: slate, corrugated steel or tiles in unglazed terracotta or dark earth tones.

### *Landscaping and site coverage*

- C22 The building footprint and paved surfaces (patios, pathways, tennis courts) and swimming pools together are not to exceed 75% of the site area in order to provide 25% of the site area for landscaped area, including plantings.
- C23 Structures and infrastructure, including swimming pools and water pipes, are to be designed (including the underside) to minimise the visual impacts upon the reserve and its significant elements (including sandstone rock shelves) when viewed from public areas.
-

## Fences and walls

### *Marine Parade*

C24 Fence heights are to be a maximum 1.2m above promenade level or, where privacy from the promenade is an issue, up to 1.8m maximum with 50% transparency above 1.2m. Acceptable materials are sandstone or face brick or rendered or painted masonry in keeping with the building to which it relates.

### *Robertson Place*

C25 Existing low brick fences facing Robertson Place are to be retained.

### *Salisbury Street*

C26 Fences are to be a maximum of 1.2m above footpath level and are to be in keeping with the building to which they relate. Brush fences, concrete block, or copies of iron palisade fences are not traditionally associated with houses in this precinct and are not permitted.

### *Gibsons Beach Reserve*

C27 Fence heights are to be a maximum 1.2m above the walkway level or rockshelf or, where privacy from the reserve or security is an issue, up to an 1.8m maximum with a 50% transparency above 1.2m. Acceptable Materials are sandstone or rendered and painted masonry in keeping with the building to which it relates.

### *Rear and side fences (when not street or reserve fronting)*

C28 Fences are to be traditional timber paling fences of 1.8m maximum height.

## Car parking and access

C29 Garages or carports are not to be built to the street frontage, and are to be set back behind the main building whether attached or freestanding.

C30 A maximum of two garages may be visible from the street provided that a minimum of 50% of the width of the street frontage is retained for landscaped area.

C31 Parking may be accommodated in a basement or semi -basement level.

### ***Gibsons Beach Reserve and Marine Parade promenade and maritime structures***

Given its public ownership, it is strongly recommended that the structures and the reserve are conserved and managed through specific management plans that include or are informed by the following management policies:

C32 The existing topography and vegetation is to be maintained. New plantings are to be of the same scale and species to that existing, except where these are inconsistent with the



---

principal character of the precinct. New plantings are not to obscure existing public views and vistas.

- C33 Existing extensive views to and from the waterfront are to be retained. No additional marine structures are to be erected in this area to retain the open landscape character of this part of the beach.
- C34 The existing public access, including disabled access, is to be retained along the promenade to the beach and the reserve.
- C35 New development and alterations and additions to existing buildings are not permitted except where consistent with the policies in the adopted management plan, including those for siting, orientation, height limits and design.
- C36 Structures and infrastructure, including swimming pools and water pipes, are to be designed to minimise the visual impacts upon the precinct and its significant elements when viewed from public areas.
- C37 No additions are to be made to the building envelopes of the existing marine structures (jetties and pilot station).
- C38 New structures are to be limited to commemorative structures, public artworks, interpretive signage and the like, the number of which are to be carefully controlled so as not to result in a visual cluttering of the landscape.
- C39 Beach dinghies are permitted against the promenade edge provided these do not impede public access.
- C40 No additional fencing is to be constructed. If essential, any new fencing is to be low in height (1.2m maximum) and constructed of sandstone, concrete or rendered masonry in neutral tone colours.
- C41 Stormwater run-off into the Harbour is to be carefully managed to protect the seahorse colony in the seagrass beds off the beach.
- C42 No additional car parking or vehicular access is permitted.
- C43 Any new paths throughout the precinct are to be constructed using recessive colours and finishes.
- C44 The management plans should incorporate a cohesive approach for the public areas along Marine Parade, in terms of paving, street furniture, lighting, signage and the like.
- C45 The public domain provisions in Section C3.7 of this chapter apply to the publicly accessible areas of the precinct.

### C3.4.15 Precinct P: Upper Gap Park

---

#### Character statement

Upper Gap Park forms part of the spectacular gateway to Watsons Bay on its approach from Old South Head Road.

It consists of an exposed sandstone ridge with sheer cliffs at its eastern edge, which form a rugged and dramatic coastline. Low coastal plantings soften this rocky landscape.

Extensive views to Watsons Bay and the Tasman Sea are available from throughout the park.

**FIGURE 140**

Aerial view of the precinct



**FIGURE 141**

Sandstone cliff faces and coastal vegetation



**FIGURE 142** Extensive views from within the Park across Watsons Bay and the harbour



**FIGURE 143**

Sheer sandstone cliffs along east edge of precinct



**FIGURE 144** Monument at south end of the park

### PRECINCT GUIDELINES

The precinct specific guidelines supplement the general controls for development in Section C3.5. If there is an inconsistency between these precinct guidelines and the general controls, the guidelines take precedence.

Given its public ownership, it is strongly recommended that this precinct is conserved and managed through a specific management plan that includes or is informed by the following management policies:

- G1 The existing topography and vegetation should be maintained. New plantings should be typical Hawkesbury sandstone heath community plants of the same scale and species to those existing. New plantings should not obscure existing views and vistas. Additional plantings of Norfolk Island Pines and Fig trees are not appropriate in Upper Gap Park. Existing pines and fig trees should be retained as cultural plantings.
- G2 The existing extensive public views to and from Watsons Bay, Sydney Harbour and the waterfront, The Gap and within the park should be retained.
- G3 To retain the open landscape setting and ruggedness of the topography, no new structures should be constructed within the park.
- G4 Existing monuments should be maintained as contributory items. New structures should be limited to commemorative structures, public artworks, interpretive signage and the like, the number of which should be carefully controlled so as not to result in a visual 'cluttering' of the landscape.

- G5 No additional fencing should be constructed. New safety fencing should be constructed as low as possible whilst still serving its purpose. It should be constructed of materials that withstand tough marine and coastal conditions, are appropriate in terms of the character of the landscape and do not obstruct views and vistas.
- G6 No additional car parking or vehicular access should be provided.
- G7 The existing public access (including disabled access) throughout the park should be retained. Public access within the park to The Gap should be retained.
- G8 Any new paths throughout the precinct should be constructed using recessive colours and finishes.
- G9 The public domain controls in Section C3.7 of this chapter apply to the publicly accessible areas of the precinct.

***Contributory items***

Note: Heritage items as identified in Schedule 5 of Woollahra LEP 2014 are also contributory items. Refer to clause 5.10 of the LEP for heritage conservation controls.

Contributory items	
Within Gap Park	Sandstone landforms, weathered rock formations and coastal heathland, including a sequence of ‘green open spaces’

---

### C3.4.16 Precinct Q: HMAS Watson

---

#### Character statement

This precinct comprises approximately 15 hectares of Commonwealth owned land at South Head known as HMAS Watson (Figure 147). It occupies a large portion of South Head and is surrounded by a fence that separates it from the adjoining Sydney Harbour National Park, including Inner South Head (Precinct T) and Gap Bluff (Precinct S) as well as Upper Gap Park (Precinct P).

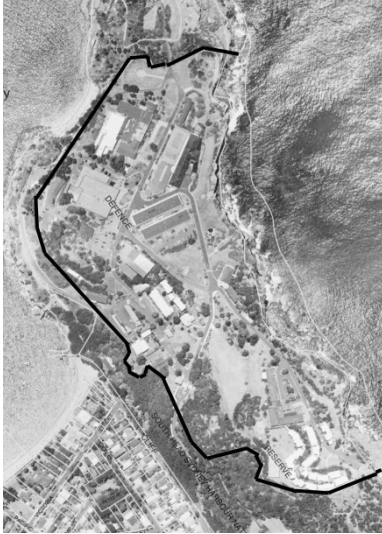
The natural landform of the precinct consists of a ridge of sandstone with a series of rock benches, platforms and steep cliffs to the coastline along its eastern edge. Due to its dominant position on South Head over the entrance to Sydney Harbour, the precinct is highly visible from the harbour, surrounding residential areas and North and Middle Heads.

HMAS Watson is a defence training and accommodation complex which retains evidence of its historic role in the defence of Sydney Harbour including a number of gun emplacements and observation posts associated with battery and fortification sites, a former guardhouse, gun carriage coach house, married officers' quarters and officers mess. The complex also reflects continuous change over the last 120 years, in particular since the 1950s and includes the distinctive RAN Chapel (St George the Martyr Church).

The area also retains a number of documented Aboriginal rock carvings. A conservation management plan for HMAS Watson has been recently prepared on behalf of the Department of Defence.

The land within this precinct is under the control of State or Commonwealth authorities and development within it does not require consent from Council. The information in the DCP applying to this precinct is intended to provide a set of guidelines for use by HMAS Watson in the preparation of a management plan for the precinct and use in considering any future development in the precinct.

**FIGURE 145**  
Aerial view of the precinct



**FIGURE 146**  
The sandstone cliffs that define the precinct on its east side



**FIGURE 147** HMAS Watson from the harbour with Camp Cove in the foreground



**FIGURE 148** Main Entrance to Sydney Harbour National Park and HMAS Watson (from Cliff Street)



**FIGURE 149** HMAS Watson within its setting of native vegetation and cultural plantings



---

## PRECINCT GUIDELINES

The precinct specific guidelines supplement the general controls for development in Section C3.5. If there is an inconsistency between these precinct guidelines and the general controls, the guidelines take precedence.

Given its public ownership, it is strongly recommended that this precinct is conserved and managed through a specific management plan that includes or is informed by the following management policies:

- G1 Existing heritage and contributory items should be retained and appropriately managed.
- G2 The existing topography and vegetation should be maintained.
- G3 The existing bushland and mature historic plantings should be retained. The expansion of areas of native bushland is encouraged, particularly in areas adjacent to the common boundaries with the Sydney Harbour National Park to achieve compatibility and continuity along the ridgeline.
- G4 If new plantings are proposed, species should be selected that are appropriate in scale, canopy size and character to those existing in the cultural landscape. New plantings should not obscure existing views and vistas.
- G5 Existing extensive views should be retained from within HMAS Watson over Watsons Bay and to the waterfront.
- G6 It is recommended that any alterations and additions proposed to HMAS Watson facilities be guided and managed by a conservation management plan adopted by the Department of Defence.
- G7 Alterations and additions to the HMAS Watson facilities should be sited so as avoid the removal of cultural plantings and so as not to obstruct existing view corridors.
- G8 Any required new buildings on the site should be located adjacent to or within the vicinity of existing buildings (within the complex of buildings) to minimise the impact of the built environment on the character of the national park.
- G9 Any required new buildings within the HMAS Watson complex should be designed, and finished so as to be recessive when viewed from the harbour and surrounding areas.
- G10 New development should be designed to be built into the landscape and hidden from view, with particular attention being paid to roof forms, materials and the use of recessive colours (excluding white).
- G11 New fences and walls within the HMAS Watson complex should be of a low height (1.5m maximum) to retain its open character and constructed of either sandstone or timber. If higher fencing is required for security purposes, then it should be constructed of a material such as chain-wire fencing in a recessive colour that allows for view retention and minimal visual impact on the landscape when viewed from outside the complex.
- G12 Any new paths throughout the precinct should be constructed using recessive colours and finishes.

G13 The location and design of any additional car parking and vehicular access facilities should comply with the policies for such elements contained within a conservation management plan adopted by the Department of Defence.

**Contributory items**

Note: Heritage items as identified in Schedule 5 of Woollahra LEP 2014 are also contributory items. Refer to clause 5.10 of the LEP for heritage conservation controls.

Contributory items	
HMAS Watson	<p>Remains (footings) of former single officers’ quarters (asset 28)</p> <p>Cultural plantings - Coral trees, Norfolk Island Pines, Phoenix palms and Eucalyptus</p> <p>Natural vegetation - Sandstone formations with numerous rock benches and stepped platforms, remnant vegetation on higher ridge</p>

**C3.4.17 Precinct R: Green (Laings) Point and Research Station**

**Character statement**

Green (Laings) Point Reserve is a grassy elevated sandstone headland, with extensive views and water frontage to Sydney Harbour. It separates the two bays of Camp Cove and Watsons Bay (Figure 150). The area was named Green Point in 1788, and granted to Laing in 1793. The area has been formerly known as Laings or Green Point Reserve.

Apart from the former Marine Biological Research Station which is managed by the Sydney Harbour Federation Trust, this area is protected under the *National Parks and Wildlife Act 1974* and managed by the National Parks and Wildlife Service. The information in the DCP applying to this precinct is intended to provide a set of guidelines for use by the National Parks and Wildlife Service in the preparation of a plan of management for the precinct and use in the assessment of development proposals.

Green (Laings) Point Precinct is a significant cultural landscape within the Watsons Bay area featuring coral and paperbark trees, a monument to the landing of the First Fleet, evidence of defence structures and the historic marine biological research station.

Contributory items include:

- A navigational marker (obelisk) erected in 1858 to mark the eastern passage into the harbour;
- A submarine miners’ firing station, which operated the electronic minefield that extended across the harbour opening (1871-1892) including the officers’ quarters (currently used as NPWS staff accommodation) and a concrete base for a searchlight tower;
- A small concrete base to the boom-winch house which is evidence of the anti-torpedo and midget submarine boom net that operated throughout World War II;



- ▶ Remnants of an anti-motor torpedo boat defensive battery, including gun emplacements, magazine, crew shelter and command (observation) post;
- ▶ The historic former Marine Biological Research Station; and
- ▶ A memorial erected to the first landing at Sydney Harbour.

Views to, from and across Sydney Harbour and to, from and across Camp Cove Beach to South Head are also significant.

**FIGURE 150**  
Aerial view of the precinct



**FIGURE 151** Green (Laings) Point Reserve from the harbour with the former Marine Biological Research Station at left



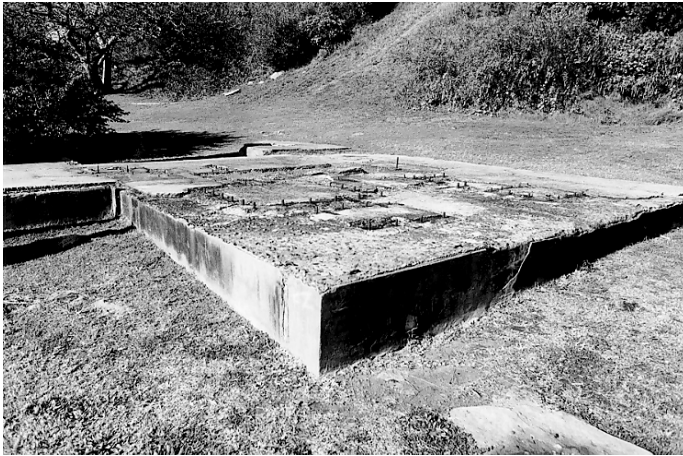
**FIGURE 152** Views across the harbour to the city from Green (Laings) Point Reserve



**FIGURE 153** Entry to the anti-motor torpedo boat defensive battery



**FIGURE 154** Concrete base to the boom-winch house



**FIGURE 155** Phillip Memorial



### PRECINCT GUIDELINES

The precinct specific guidelines supplement the general controls for development in Section C3.5. If there is an inconsistency between these precinct guidelines and the general controls, the guidelines take precedence.

Both the Sydney Harbour Federation Trust (SHFT) and the National Parks and Wildlife Service (NPWS) have prepared management plans for the lands under their control. It is recommended that the individual management plans be reviewed to include or be informed by the following policies:

- G1 The existing landform of the ridge, slope and rock platform down to the low water mark should be maintained.
- G2 Excavation of the rock platform to create footings for jetties, boat ramps or other similar structures should not be permitted.
- G3 Mature historic plantings should be retained.
- G4 If new plantings are proposed, selected species should be appropriate in scale, canopy size and character to those existing in the cultural landscape.
- G5 New plantings should not obscure existing views and vistas.
- G6 The lower level of the reserve adjacent to the waterfront should retain its open grassy character.
- G7 Jetties, boat ramps and similar structures should not be built over the rock shelf.
- G8 Existing extensive views should be retained from the waterfront, particularly the views from the open lower level of Green (Laings) Point Reserve
- G9 New development and alterations and additions to existing buildings should not be permitted, except where consistent with the policies contained within an adopted

conservation management plan, including those for siting, orientation, height limits and design.

- G10 Unsympathetic existing development should be relocated to be less obtrusive and/or replaced with more sensitively designed structures. Alternatively, other work should be undertaken to improve the visual amenity of such structures, including design and colour alterations. The existing public toilet block should be screened from the waterfront by appropriate plantings.
- G11 Fences around existing buildings within Green (Laings) Point Reserve should be of a traditional timber picket to the water side and palings at sides and rear.
- G12 Height of fencing should be restricted to 1.2m maximum at the waterfront side and 1.8m at the sides and rear.
- G13 No additional public car parking should be provided within the precinct in order to retain its open green character.
- G14 Vehicular access to building complexes within Green (Laings) Point Reserve is to be via existing driveways only.
- G15 The existing public access should be retained to all foreshore areas.
- G16 Any new paths throughout the precinct should be constructed using recessive colours and finishes.
- G17 The public domain provisions in Section C3.7 of this chapter apply to the publicly accessible areas of the precinct.

### Contributory items

Note: Heritage items as identified in Schedule 5 of Woollahra LEP 2014 are also contributory items. For the protection of heritage items refer to clause 5.10 of the LEP.

Contributory items	
36 Pacific Street	Single storey Victorian weatherboard Keepers Cottage
Green [Laings] Point Reserve	Green Point obelisk [REP23] – a Victorian sandstone obelisk Royal Australia Historical Society sandstone monument to Captain Phillip's landing at Camp Cove on 21 January 1788 Base of winch house for WW2 anti-torpedo and midget submarine boom net Sandstone rock benches, talus deposits and Platforms Ornamental plantings to northern edge [Coral trees and Melaleucas] Remnant plantings to SW [Hills weeping fig and Port Jackson fig]

### C3.4.18 Precinct S: Sydney Harbour National Park (Gap Bluff)

#### Character statement

Sydney Harbour National Park (Gap Bluff) Precinct is bounded by sheer sandstone cliffs on part of its eastern edge and consists mainly of a linear, uneven ridge that runs north-south as a series of platforms (narrow and wide at various points), broken by rock benches.

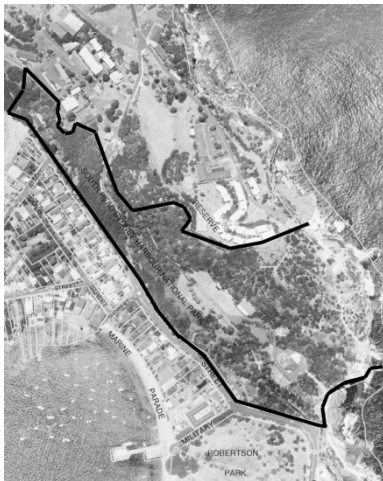
The area retains evidence of earlier defence structures including gun emplacements, the former artillery school and constable's cottage group.

Although a number of buildings exist within the park (currently used as the Gap Bluff Function Centre), they are dominated by the natural topography and vegetation.

Local native plants are complemented by cultural and ornamental plantings, particularly the post-World War II Norfolk Island Pines which, although they have landmark qualities, are of limited heritage landscape significance.

This area is protected under the *National Parks and Wildlife Act 1974* and managed by the NPWS. The information in the DCP applying to this precinct is intended to provide a set of guidelines for use by the National Parks and Wildlife Service in the preparation of a plan of management for the precinct and use in the assessment of development proposals.

**FIGURE 156**  
Aerial view of the precinct



**FIGURE 157**  
Views across Watsons Bay and the harbour to the city



**FIGURE 158** Remnants of gun emplacements and the former artillery school are located at the north end



### PRECINCT GUIDELINES

The precinct specific guidelines supplement the general controls for development in Section C3.5. If there is an inconsistency between these precinct guidelines and the general controls, the guidelines take precedence.

Given its public ownership, it is strongly recommended that this precinct is conserved and managed through a specific management plan that includes or is informed by the following management policies:

- G1 The existing topography and vegetation should be retained.
- G2 Mature pre-1945 plantings should be retained. If new plantings are proposed in the vicinity of existing buildings, species should be selected that are appropriate in scale, canopy size and character to those within their existing curtilage. New plantings should not obscure existing public views and vistas.
- G3 Beyond the curtilage of historic buildings, plantings should comprise typical Hawkesbury sandstone heath community plants on exposed platforms and eastern suburbs banksia scrub species in more moist, sheltered western aspects.
- G4 The plantation of coral trees in the northwest area of the precinct adjacent to the car park in Cliff Street should be retained, but no further plantings of these trees should be added elsewhere within the park.
- G5 Existing extensive views should be retained from within the Park over Watsons Bay and to the waterfront.
- G6 Alterations and additions to the Gap Bluff Function Centre should be guided by and be consistent with an adopted management plan, including policies for siting, orientation, height limits and design as well as car parking.
- G7 Alterations and additions to the Gap Bluff Function Centre should be sited so as to avoid the removal of cultural plantings and so as not to obstruct existing view corridors.
- G8 New buildings should be orientated to minimise visual impact when viewed from the water and surrounding areas.

- G9 Any required new buildings on the site should be located adjacent to the Gap Bluff Function Centre complex to minimise impact on the open green character of the National Park.
- G10 Any required new buildings should be constructed at a height that is equal to or lower than that of existing buildings within the Gap Bluff Function Centre complex.
- G11 New structures should follow established forms, i.e. simple rectilinear plan buildings of a small scale with pitched roofs. New development should not include flat roofed buildings. Roof colours should be recessive.
- G12 Only essential new fences and walls should be erected within the National Park. These should be constructed of either sandstone or timber and be of a low, 1.2m maximum height so as to retain the open character of the park.
- G13 Higher security fencing should be constructed of a material that allows for view retention and minimal visual impact on the landscape, such as black chain-wire fencing.
- G14 Only essential additional car parking on existing paved surfaces should be permitted. The locations and design of any additional car parking and vehicular access facilities should be consistent with an adopted management plan.
- G15 The upper and lower level car parks should be provided with additional canopy trees and perimeter shrubs to increase shade and amenity and to provide greater vegetative screening of highly reflective vehicle surfaces.
- G16 The existing public access (including disabled access) should be retained throughout the National Park. The public access from the upper levels of the park to the waterfront should be retained.
- G17 Any new paths throughout the precinct should be constructed using recessive colours and finishes.
- G18 The public domain controls in Section C3.7 apply to the publicly accessible areas of the site.

**Contributory items**

Note: Heritage items as identified in Schedule 5 of Woollahra LEP 2014 are also contributory items. Refer to clause 5.10 of the LEP for heritage conservation controls.

Contributory items	
NE of the Tide Station on Camp Cove Beach	Remains of the former boatshed and ramp at the inlet
South Head Sydney Harbour National Park	<b>Cultural plantings</b> Coral trees, Phoenix palms and Norfolk island pines along Entrance Road

### C3.4.19 Precinct T: Sydney Harbour National Park (Inner South Head)

---

#### Character statement

This precinct consists of a rugged coastline fronting both the harbour and the open sea (Figure 161). The natural topography of the west (harbour) edge and the peninsula (South Head) is marked by the historic Hornby Light and associated lighthouse keeper's cottages.

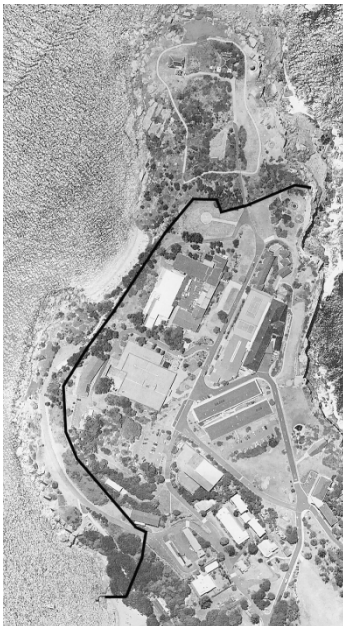
In conjunction with the adjoining HMAS Watson (Precinct Q) and Green (Laings) Point (Precinct R), this area has played an important historic role in the defence of Sydney Harbour since the 1870s.

The narrow, secluded sandy beach of Lady Bay, which disappears at high tide, is defined by sandstone rock benches and cliffs. Built evidence of the historic role this area had in the defence of Sydney Harbour exists in the form of historic gun emplacements overlooking the entrance to the harbour and Camp Cove.

The precinct also features extensive views across the harbour entrance to North Head and across the harbour to the city.

This area is protected under the *National Parks and Wildlife Act 1974* and managed by the National Parks and Wildlife Service in conjunction with Gap Bluff (Precinct S) and Green (Laings) Point (Precinct R). The information in the DCP applying to this precinct is intended to provide a set of guidelines for use by the National Parks and Wildlife Service in the preparation of a plan of management for the precinct and use in the assessment of development proposals.

**FIGURE 159** Aerial view of the precinct



**FIGURE 160** Rugged coastline of sheer sandstone cliff faces



**FIGURE 161** Former defence structures and extensive views across the entrance to the harbour



**FIGURE 162** Former gun emplacement overlooking Camp Cove



**FIGURE 163**  
Extensive views across the harbour to the city



**FIGURE 164** Hornby Light



## PRECINCT GUIDELINES

The precinct specific guidelines supplement the general controls for development in Section C3.5. If there is an inconsistency between these precinct guidelines and the general controls, the guidelines take precedence.

Given its public ownership, it is strongly recommended that this precinct is conserved and managed through a specific management plan that includes or is informed by the following management policies:

- G1 Existing topography and vegetation should be maintained.
- G2 Mature historic plantings should be retained. If new plantings are proposed, select species that are appropriate in scale, canopy size and character to those existing in the cultural landscape. New plantings should not obscure existing public views and vistas. Refer to Section 3.5.6 Landscaping and private open space.
- G3 Existing extensive public views to and from the waterfront should be retained.



- G4 The existing public access (including disabled access) should be retained throughout the national park. Any new paths within the precinct should be unobtrusive and not constructed of concrete. They should be edged with low border plantings to minimise the visual impact when viewed from above.
- G5 Alterations and additions to existing buildings should be guided and managed by appropriate conservation policies. Alterations and additions to existing buildings should be sited so as not to obstruct existing public view corridors.
- G6 No new development should occur except where consistent with the policies in the adopted management plan for siting, orientation, height limits and design.
- G7 Any required new buildings (including ancillary structures for maintenance equipment and the like) on the site should be located adjacent to existing buildings to minimise the impact of the built environment on the open green character of the national park.
- G8 Any required new buildings should be located and designed to minimise the visual impact of such structures when viewed from the water and surrounding public areas.
- G9 Any required new buildings should be constructed at a height that is equal to or lower than the ridgeline heights of existing buildings and be surrounded by vegetation. New structures should follow established forms, i.e. simple rectilinear plan of a small scale with pitched roofs. Flat roofed buildings are not appropriate.
- G10 Only essential new fences and walls should be erected within the national park. These should be of a low height (1.2m maximum) to retain the open character of the park and constructed of either sandstone or timber. Higher security fencing should be constructed of a material that allows for view retention and minimal visual impact on the landscape, such as black chain-wire fencing.
- G11 No public vehicular access is permitted in this area of the national park. The location and design of car parking and vehicular access facilities (limited to maintenance/service vehicles) should be consistent with the policies for such elements in an adopted management plan.
- G12 Any new paths throughout the precinct should be constructed using recessive colours and finishes.
- G13 The public domain provisions in Section C3.7 apply to the publicly accessible areas of the site.

### Contributory items

Note: Heritage items as identified in Schedule 5 of Woollahra LEP 2014 are also contributory items. Refer to clause 5.10 of the LEP for heritage conservation controls.

#### Contributory items

Within South Head Sydney Harbour National Park	Natural landscape Rugged Hawkesbury sandstone formations, natural vegetation and sandy beaches
--	--

---

## C3.5 General controls for all development

Development is to respect and enhance the character of Watsons Bay. It must not detract from the scale or character of the streetscape or the conservation area generally.

This section contains general controls which apply to development including:

- ▶ infill or replacement development, also referred to as new development; and
- ▶ alterations and additions to existing buildings.

The matters addressed in this section are:

- ▶ 3.5.1 Topography and vegetation
- ▶ 3.5.2 Townscape
- ▶ 3.5.3 The waterfront
- ▶ 3.5.4 Views and vistas
- ▶ 3.5.5 Built form (including building siting and alignment, building height, building form, building character and building materials and design)
- ▶ 3.5.6 Landscaping and private open space
- ▶ 3.5.7 Fences and walls
- ▶ 3.5.8 Car parking and access
- ▶ 3.5.9 Site facilities and aerial devices
- ▶ 3.5.10 Acoustic and visual privacy

The controls in this section apply in addition to:

- ▶ Section C3.3 Objectives for development; and
- ▶ Section C3.4 Precincts.

If there is an inconsistency between the general controls and the precinct controls, the precinct controls take precedence.

If compliance with a general control cannot be achieved, it must be demonstrated that the objectives of the control can be met (refer to Section C3.3).

---

### C3.5.1 Topography and vegetation

---

Note: The objectives for these controls are in Section C3.3 Objectives for development.

#### Controls

- C1 Development is not to alter natural sandstone cliff faces and outcrops.
- C2 Development is not to protrude above the height of natural clifflines or to obscure or detract from views of the landform from major public vantage points including the harbour.
- C3 Development on sites located on ridgelines and on sloping sites is to be of a height that will complement the natural topography of the site and the surrounding environment; that is, it should broadly follow the contours of the land. To achieve this, development is to be of a similar height to neighbouring dwellings.
- C4 Development is to step down sloping sites.
- C5 Bulky structures that would adversely affect the visual appreciation of the landform are not permitted.
- C6 Native planting is to be retained and protected where present.
- C7 Significant cultural plantings, including but not limited to those identified as contributory items, are to be retained, except where removal is necessary due to ill health. (Where significant cultural plantings are removed due to ill health, they are to be replaced with a species that has an appropriate character, mature height limit and spread.)

---

### C3.5.2 Townscape

---

Note: The objectives for these controls are in Section C3.3 Objectives for development.

#### Controls

- C1 The mix of small scale, close knit dwellings and larger waterfront houses north of Robertson Park is to be retained.
- C2 The predominant one and two storey scale of the residential precincts is to be retained to protect their character, retain significant views and vistas and to enhance view sharing.
- C3 Existing development patterns, including building footprint size and spacing between buildings, are to be retained based on precinct type. Refer to Section C3.4 Precincts.
- C4 The predominant pattern of subdivision and lot sizes is to be retained. Re-subdividing of properties into narrower, smaller allotments is not permitted where this would alter subdivision patterns or compromise the setting of the existing building on the site or on the setting of the adjoining sites.
- C5 Amalgamation of allotments is not permitted unless resulting development is of a form that reflects the character of single detached dwellings on separate allotments with setbacks from boundaries. The size and location of garden areas must be similar to predominant patterns in the area.
- C6 The existing street pattern is to be retained without road widening.
- C7 The existing public lanes and passageways that service Watsons Bay are to be retained.
- C8 Contributory items and natural and landscape features that contribute to the significance of the area are to be retained and conserved.
- C9 Extensive cut and fill or retaining walls that would detract from the appearance of the natural landform or streetscape character are not permitted.

---

### C3.5.3 The waterfront

---

Note: The objectives for these controls are in Section C3.3 Objectives for development.

#### Controls

- C1 Development is not to further encroach onto existing public foreshore promenades or beaches.
- C2 Development is to retain the visual links between the water and foreshore areas.
- C3 Commercial development is not permitted within the public domain, other than in those areas that are already used commercially.
- C4 No development is permitted that would prevent public access to the shoreline or create the impression of the foreshore being a private area.
- C5 Development on foreshore properties is not to alter natural foreshore features including cliffs, rock outcrops, rock shelves and beaches.
- C6 Slipways and stairs are to be designed and constructed to closely conform with the character of the natural foreshore.
- C7 Development on foreshore properties is not to increase current levels of site stormwater or sediment run-off entering the harbour.
- C8 Historic maritime structures are to be retained in situ.
- C9 Building forms are to follow the natural topography and maintain or enhance vegetation cover as viewed from the harbour.
- C10 New maritime structures (including wharves, jetties and boatsheds) are not to be constructed on, nor to shade, seabeds or seagrass habitats identified as sensitive marine environments and are not to be sited upon rock shelves.
- C11 The design of new maritime structures is to be sympathetic to the character of the surrounding environment and not impede significant public views to the harbour from within the conservation area, or views to the beaches from the harbour.
- C12 Pergolas, boatsheds and other outbuildings and structures are to be designed and constructed to complement the overall appearance of the development. Such structures are to be no more than a single storey in height.
- C13 Boatsheds are to have a direct relationship with the water, with openings and access facing the water.
- C14 Boatsheds are to be used solely for the storage and/or maintenance of boats and are not to be used as dwellings. Boatsheds that include washing or showering facilities, hand basins, toilets, cooking facilities or habitable rooms are not permitted.
- C15 Boatsheds are to have maximum plan dimensions of 6m x 3.7m. Boatsheds are to be sited so that the minimum dimension fronts the harbour.

- C16 Boatsheds are to incorporate gable pitched roofs with a minimum pitch of 30°. The use of roofs as sundecks, patios or the like is not permitted.
- C17 Boatsheds are to be single storey with a maximum wall height of 2.5m.
- C18 Boatsheds are to be constructed of solid materials such as stone or timber. Large areas of glazing are not permitted.
- C19 Jetties are to be of minimum size, constructed of hardwood and designed to be as unobtrusive as possible. The sharing of jetties between properties is encouraged and, where possible, jetties are to be constructed on common boundaries to limit the proliferation of structures along the foreshore.

### C3.5.4 Views and vistas

---

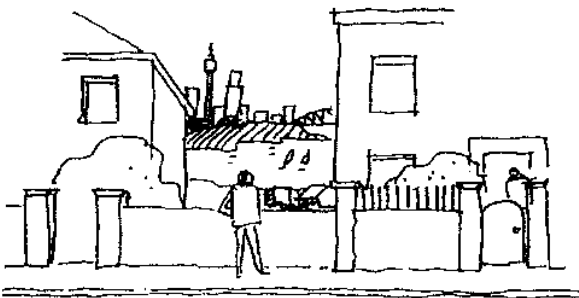
Note: The objectives for these controls are in Section C3.3 Objectives for development.

#### Controls

- C1 View corridors identified from the public domain in the Watsons Bay HCA precinct map are to be retained.
- C2 Development is to be designed (including bulk and heights of proposed buildings and vegetation) and located to minimise impact on existing views.
- C3 Development is to include opportunities to reinstate identified blocked views and vistas.
- C4 Development is not to block views to Watsons Bay from elevated locations including along Old South Head Road from Gap Park, from Robertson Park and the foreshore.
- C5 Roofs of development are to be designed and oriented to ensure views from more elevated locations and visual gateways are retained. Photomontages are to be submitted with development applications demonstrating retention of key views.
- C6 Buildings must be setback from side boundaries and adjacent sections of front fences are to be transparent in order to retain and restore view corridors between the street and the harbour.
- C7 Building forms are to enable a sharing of views with surrounding residences (refer to Figures 166 and 167).

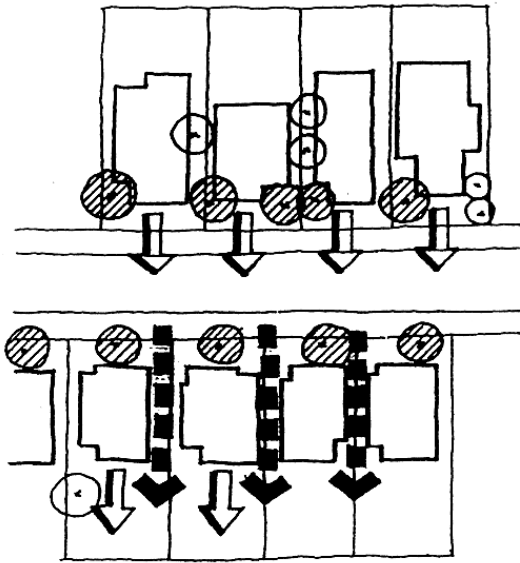
#### FIGURE 165

Existing views to the harbour between building side setbacks



**FIGURE 166**

Creating streetscapes that allow for the retention of significant views



**FIGURE 167**

Articulated building forms and setbacks that enable view sharing





---

### C3.5.5 Built form

---

Note: The objectives for these controls are in Section C3.3 Objectives for development.

The controls below apply to new buildings (infill development) as well as alterations and additions to existing buildings. For contributory items, the controls below apply in addition to the built form controls for contributory items in Section C3.6. If there is an inconsistency between the general controls and the controls for contributory items, the contributory item controls prevail.

#### Controls

##### *Building footprint*

- C1 The building footprint is not to exceed 60% of the site area unless stated otherwise in the precinct controls. Total built upon area including paths, driveways, tennis courts, swimming pools and all hardstand areas must not exceed 75% of the site area with a minimum of 25% to be deep soil landscaped area unless stated otherwise in the precinct controls.
- C2 The proportion of site coverage is to be no greater than that of adjoining properties and surrounding areas.
- C3 Building footprints for residential flat buildings, manor houses, multi dwelling housing and multi dwelling housing (terraces) are limited to 40% of the site area unless stated otherwise in the precinct controls.
- C4 Existing development patterns, including building footprint size and spacing between buildings, are to be retained based on precinct type. (Refer to Section C3.4 Precincts).

##### *Excavation*

Excavation is an accepted part of development in the Woollahra Municipality where the topography varies. Excavation allows buildings on the sloping sites to be designed to step down and sit into the hillside, and it also enables cars and storage to be accommodated on site in an unobtrusive manner.

However, there are significant environmental impacts associated with extensive excavation, as well as external impacts, such as amenity impacts to adjoining properties during the excavation process.

Council has determined that the volume excavated from a given site should be limited to that which might reasonably be required for car parking and domestic storage requirements, and to allow the building to respond to the site topography in an appropriate manner.

- C5 For a dwelling house, dual occupancy or semi-detached dwelling - the maximum volume of excavation permitted is no greater than the volume shown in Figure 168.

---

C6 For a residential flat building, manor house, multi dwelling housing and multi dwelling housing (terraces), or attached dwelling development - the maximum volume of excavation permitted is no greater than the volume shown in Figure 169.

Note: The above volume controls in C5 and C6 do not apply to backyard swimming pools, tennis courts and the like.

C7 For any other use not addressed in C5 and C6 above - the maximum volume of excavation permitted is no greater than the volume shown in Figure 169.

C8 For a site that slopes up from the street—a variation to the volume shown in Figures 168 and 169 may be considered, however the maximum volume of excavation permitted will only be the amount needed to accommodate:

- a) car parking to comply with the maximum rates in Part E1 of this DCP and any reasonable access thereto; and
- b) storage at a rate of 20m<sup>3</sup> per dwelling if for a dwelling house, dual occupancy, semi-detached dwelling or attached housing; or
- c) storage at a rate of 8m<sup>3</sup> per dwelling if for a residential flat building, manor house, multi dwelling housing and multi dwelling housing (terraces) development.

C9 Sub-surface walls are no closer to the boundary than permitted by the setback controls (refer to Figure 171).

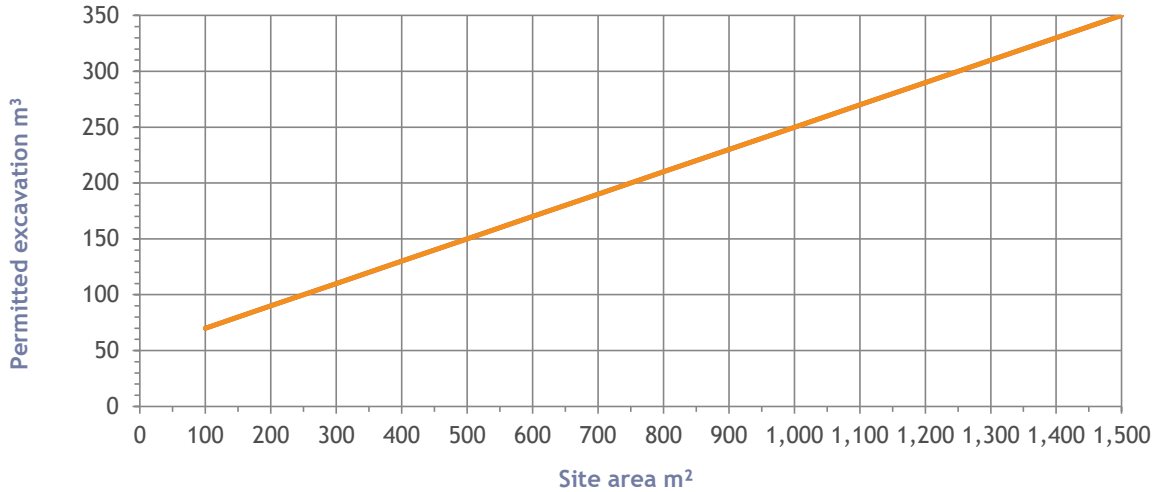
C10 Notwithstanding C9, for excavation in relation to an existing attached dwelling, semi-detached dwelling, or attached dual occupancy—excavation is not to occur under common walls, footings to common party walls, freestanding boundary walls, or footings to freestanding boundary walls.

C11 Excavation below 2m and/or within 1.5m of the boundary is accompanied by a geotechnical and hydrogeological report and a structural report demonstrating that the works will not have any adverse effect on neighbouring structures.

Note: Council may identify other circumstances where these reports are required. All reports must be prepared in accordance with Council's guidelines. Council may also require the preparation and submission of a pre-commencement dilapidation report for properties neighbouring the development.

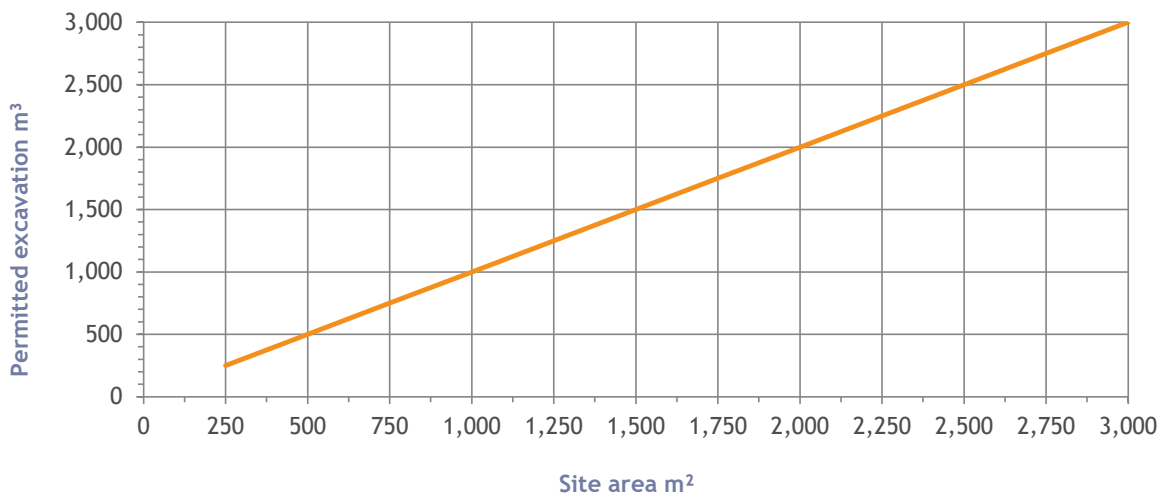
**FIGURE 168**

Maximum volume of excavation for:  
 -a dwelling house  
 -dual occupancy development  
 -a semi-detached dwelling.



**FIGURE 169**

Maximum volume of excavation for:  
 - residential flat building  
 -manor houses  
 -multi dwelling housing development  
 -multi dwelling housing (terraces)  
 -attached dwellings - any other land use not addressed in controls in controls C5 to C6 of Section 3.5.5  
 Excavation.



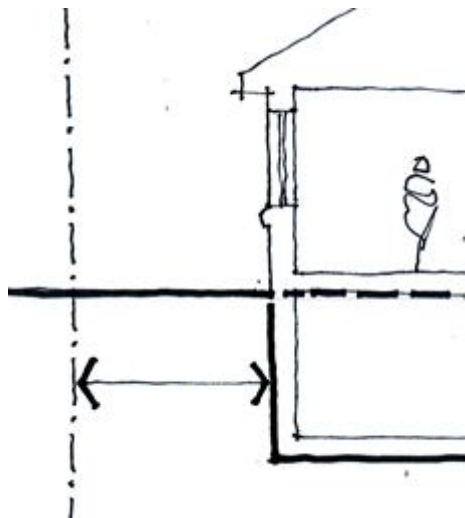


FIGURE 170  
Sub-surface walls can be no closer to the boundary than the required setback.

---

***Building siting and alignment***

- C12 Development is to adopt the established orientation patterns. Where adjoining buildings are oriented to face a view rather than the street, new development is to adopt this orientation.
- C13 Development is to conform to the existing pattern of development within the streetscape in terms of setbacks from front boundaries and footprint size.
- C14 Where there is a uniform building setback, development is to be aligned to the existing setback pattern. Development is not to be built forward of adjacent buildings.
- C15 Where there are contributory items in the street, development is to match the predominant setback of contributory items.
- C16 Where there is no uniform or predominant building setback, development is to achieve a transitional front setback between the two properties on either side.
- C17 The setback of development from side and rear boundaries is to be sufficient to ensure that the residential amenity of neighbouring properties is not unduly affected.
- C18 Rear setbacks are to relate to the existing building pattern, to provide rear yard space and to maintain the amenity of neighbouring residential property.
- C19 Notwithstanding C18 above, a deeper rear setback may be considered where:
- a) development is for a significant single storey cottage adjacent to two storey dwellings;  
or
  - b) development is on a site where the directly adjoining properties are underdeveloped;  
and
  - c) the deeper rear setback does not unreasonably impact on privacy, solar access or views of the adjoining properties.
- C20 Side setbacks are to be a minimum of 1.2m (and 1.5m on lots greater than 15m in width). A variation to setback controls may be considered where the site is less than 10m wide, comprises an irregular shape allotment, contains a service easement or shares a party wall with an adjoining property.
- C21 In waterfront precincts, the siting of development is to have regard to views to and from the waterfront and from the harbour.
- C22 Ground floor levels of development are to be similar to those of the existing building on the site and adjacent buildings with similar natural ground levels.

### ***Building height***

Note: The maximum building height control is set by Woollahra LEP 2014.

- C23 The height of buildings should not exceed two storeys, except where permitted otherwise by the precinct controls.
- C24 New buildings and additions are not to exceed the predominant height of contributory items in the street. Additionally, the height of a proposed new building may be limited to the height of an adjoining contributory item (both along the ridgeline of the roof and the height to the eaves).
- C25 Where a maximum building height of 8.2m applies (as specified in Woollahra LEP 2014)—the maximum external wall height is to be 6.7m to the underside of the eaves or the top of parapet (where proposed).
- C26 The design of new development must conform to the predominant floor and ceiling heights in adjacent contributory items.
- C27 Development is to facilitate view sharing with surrounding buildings and from public roads and public spaces.

### ***Solar access***

- C28 New buildings and additions are to be designed and sited so as to retain sunlight to at least 50% or 35m<sup>2</sup> with minimum dimension of 3m x 3m (whichever is smaller) of the main ground level private open space of adjacent properties for a minimum of 2 hours between 9am and 3pm on 21 June.
- C29 Dwellings are to include at least one north-facing room capable of use as a habitable room.
- C30 Windows to north-facing habitable rooms are to receive at least three hours of sun between 9am and 3pm on 21 June over a portion of their surface.
- C31 North-facing windows to habitable rooms of neighbouring dwellings are not to have sunlight reduced to less than three hours between 9am and 3pm on 21 June over a portion of their surface.

### ***Building form***

- C32 Buildings are not to visually overwhelm their context or be visually dominant from the street.
- C33 Development is to respect the dominant form and massing of existing development within the streetscape, in particular, adjacent or nearby contributory items.
- C34 The design of buildings is to respect the simple rectangular footprints and traditional pitched roof forms of existing dwellings in the area.
- C35 Roof forms are to be designed to present a traditional appearance (that is, sloping with hipped, gabled or skillion roof form), when viewed from the harbour.

---

***Building character***

- C36 The character of new buildings and additions is to be consistent with the character of nearby and surrounding contributory items and the character of the streetscape in which they are located.

***Dormers***

- C37 The design, proportions and materials of new dormer windows, where permitted, are to be appropriate to the architectural style of the building and the building's context.
- C38 Dormers detailed in a contemporary style may be permitted on non-contributory items where:
- a) there would be no adverse impact on adjoining contributory items; and
  - b) they would not result in privacy or amenity impacts on neighbouring properties.

***Skylights***

- C39 Skylights are not to be placed on the front plane of roofs or on other roof planes where they would be intrusive in views from the public domain or affect the amenity of neighbouring properties. The night-tie appearance (that is, when lit from below) is to be taken into consideration.
- C40 Skylights are to be limited in number to a maximum of one per 8m<sup>2</sup> of rear roof plane. This may be further reduced where dormer windows also exist in the same roof plane.
- C41 Skylights are to be of a low profile and flush with the roof surface. Colouring is to merge with the roofing material.

***Building materials and details***

- C42 Materials, finishes textures and colour schemes are to be appropriate to the architectural style of the building. No fluorescent primary colours are permitted. Intensity and hue of colour is to relate to the style of the building and to the streetscape context. Roofs are to be neutral colour range with the exception of the maintenance of original terracotta tiles.
- C43 The materials and details used are to reflect but not copy the characteristic materials, colours finishes, textures and details of existing surrounding buildings.
- C44 Solid to void ratios should be similar to those of contributory items in the vicinity.
- C45 Excessive areas of glazing will not be permitted.
- C46 Building materials are to be referenced from the predominant materials evident in the streetscape, but detailed in a contemporary manner.
- C47 External colour schemes and materials should respect the character of the streetscape and not detract from contributory items in the street.

- C48 Verandahs and balconies are to be sympathetic, contemporary design tinted or reflective glass balustrades are not permitted.
- C49 Security, where needed is to be provided by the least obtrusive method (such as shutters, mortice deadlocks, window locks and alarm systems).
- C50 Highly visible security grilles embellished with pseudo period detail over windows and doors are not permitted. Metal security doors and window grilles may be acceptable where they use simple, unembellished rectangular bars in a vertical pattern and painted in recessive colours.
- C51 Security grilles to windows are to be internally located.

***Dual occupancy development***

- C52 If development is for a dual occupancy, the additional controls for dual occupancies in Part B, Chapter B3 General Development Controls of this DCP also apply (refer to Section B3.8 Additional controls for development other than dwelling houses) .



---

### C3.5.6 Landscaping and private open space

---

Note: The objectives for these controls are in Section C3.3 Objectives for development.

#### Controls

- C1 Each dwelling located at ground level, including any dwelling house, is to provide private open space comprising a minimum area of 35m<sup>2</sup> with minimum dimensions of 3m. The principal area is to have a minimum area of 16m<sup>2</sup> with minimum dimensions of 4m at any point.
- C2 Part of the private open space is to be capable of serving as an extension of the dwelling for relaxation, recreation and entertaining and must be directly accessible from the main living areas. Stairways and ramps may be used to provide access to these areas on sloping sites.
- C3 The raising of open space areas to provide level access from a building is not permitted if this would impact on the amenity of adjoining properties or the significance of the property generally.
- C4 Landscaped area is to comprise at least 25% of the site area. At least 40% of the landscaped area is to be deep soil landscaped area.

#### *Vegetation guidelines for landscaping*

- C5 Landscaping is to consist of vegetation types and landscaping styles that blend the development into the streetscape and which will not block identified views and vistas.
- C6 Existing significant trees and vegetation are to be retained and incorporated into proposed landscape treatment.
- C7 Where plantings are to be removed due to ill health they are to be replaced with a species that has an appropriate character, mature height limit and spread. Where the removed tree is a cultural planting, it should be replaced with the same species, subject to site constraints. Alternatively, it would be appropriate to use cultural plantings associated with the principal period of the area's development.
- C8 Planting is to be selected to ensure that the mature height and canopy spread would not be excessive for the limited space available, and not obstruct major views to the harbour from private properties and public viewing points further up the slope.
- C9 Trees and other vegetation are to be of a size and species that will not have an adverse impact on the fabric of buildings and works and have minimal adverse impact on the amenity of the occupiers of adjoining properties.
- C10 Plantings in the vicinity of contributory items are to be of a solid, bold, sculptural form with rich green canopy and generally not taller than 10m in mature height. While they should help frame and provide an appropriate backdrop to the contributory items, new plantings are to be planted a minimum of 7.5m away from the nearest contributory item so as not to affect their foundations, roofs or views or their spires.

---

C11 Pines such as Norfolk Island, Cook Island, Hoop and Bunya, and other large scale trees, are not permitted as they become too large for private open space, potentially damaging buildings and overshadowing neighbouring properties.

Note: Palms are not appropriate as they contribute little to the greening and amenity of the area. Where palms are used, they are not to exceed 25% of the number of trees within the planted area of an allotment. Preferred palms are Howea (Kentia), Bangalow and Cabbage Tree palms.

Small scale trees such as Frangipani, Crepe Myrtle, Chinese Tallowood, New Zealand Christmas Tree, flowering fruit trees and ornamental pears, Blueberry Ash and Lillypilly, are appropriate in private open space.

The use of native species with ornamental plants is acceptable where these tolerate similar growing conditions (watering, fertilising and pruning), but generally they should be kept as specimen plants or grouped together with other native plants. Generally, planting should be 'tiered', with taller shrubs along boundary fences, lower shrubs in front of them, and groundcovers meeting a lawn (if one is provided).

### *Swimming pools*

C12 Swimming pools are not permitted in front gardens between the house and the street.

C13 Swimming pools may be permitted in front gardens along waterfronts, but are not to be constructed on rock shelves.

C14 A swimming pool is only permitted in front gardens along the waterfront where the coping will be flush with or no higher than 300mm above the existing ground level. No portion of the pool casing is to be visible from the water.

C15 Swimming pools in the rear of properties are not to have an adverse impact on the amenity of adjoining properties.

C16 Swimming pools in the rear of properties are not permitted if the construction of the pool would result in the removal of identified significant trees and vegetation.

---

### C3.5.7 Fences and walls

---

Note: The objectives for these controls are in Section C3.3 Objectives for development.

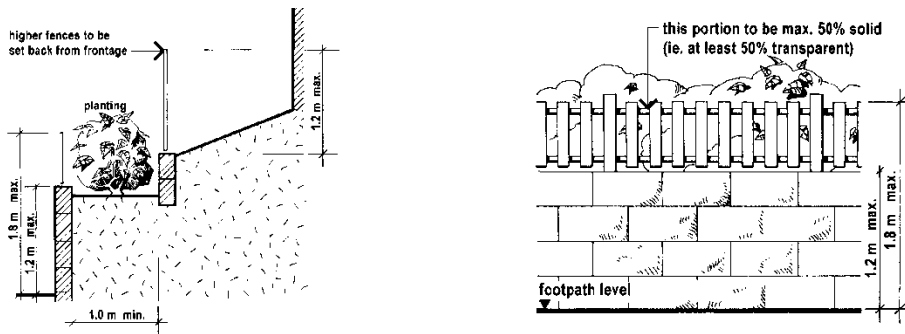
#### Controls

- C1 Existing sandstone walls with significance should be retained.
- C2 Fences styles and heights are to be based on the architectural style of the building and appropriate traditional heights.
- C3 Fences and gates on infill sites are to be of a contemporary design and use details and materials that conform with the building's context.
- C4 The design and materials of front fences is to be compatible with the appropriately designed fences in the streetscape and the heritage context of the area.
- C5 For sloping sites, the height of fences and walls may be averaged and fences and walls may be regularly stepped.
- C6 Front fences and walls are to be no higher than 1.2m above footpath level unless a taller fence is permitted in the precinct controls. Corner sites must maintain an open form front fence to maintain visibility for traffic and pedestrians.
- C7 On sites where the ground level is above the footpath level, a taller fence up to 1.8m max (above footpath level) a taller fence up to 1.8m max (above footpath level) may be permitted if the upper portion of the fence above 1.2m is not more than 50% solid (see Figure 171).
- C8 Gates are to be designed so as not to encroach over the street alignment when opening or closing.

#### *Side and rear fences and walls*

- C9 Side and rear boundary fences are to be no higher than 1.8m on level sites or 1.8m as measured from the low side where there is a difference in level either side of the boundary.
- C10 Where there is difference in ground level in excess of 1.2m of either side of the boundary the height of fences and walls between allotments may be up to 1.5m above the ground level of the high side.

**FIGURE 171** Maximum fence and wall heights



### C3.5.8 Car parking and access

Note: The objectives for these controls are in Section C3.3 Objectives for development.

#### Controls

Refer also to Part E of the DCP, Chapter E1 Parking and Access for parking generation rates and general parking requirements.

- C1 The provision of on-site parking structures, parking areas, driveway access and servicing areas (such as loading facilities) is not a general requirement of Council and may not be permitted in any of the following circumstances:
- if new garages or carports or parking areas would adversely affect the appearance of existing heritage or contributory items or the character of the existing building or streetscape;
  - if the parking of a vehicle will have a detrimental impact on the amenity of adjoining properties;
  - if vehicle entries and exits have a detrimental impact on pedestrian or traffic movements;
  - if inadequate sight distances will result in unsafe vehicle movement to or from the site; or
  - if there will be an adverse impact on the effective use of on-street public parking spaces or public parking management.
- C2 The height and bulk of new garages and carports, whether attached or freestanding, is to be subservient to the existing building on the site and to adjacent buildings.
- C3 All car parking is to be provided behind the front wall of the dwelling, preferably at the rear of the property. Exceptions may be considered only where the streetscape is characterised otherwise (in particular, in Precinct H and J).
- C4 No additional vehicle crossovers are permitted off street frontages where these would result in the removal of original sandstone kerbing.

- 
- C5 In streetfront situations where a single crossover exists, it is not to be expanded to facilitate double/multiple garages.
- C6 In streetfront situations where a crossover exists, new garage and carport structures are to be of a design and constructed of materials that respond to the relevant aspects of the historic context, including existing buildings and the streetscape. A sympathetic contemporary design is preferred to historic imitation.
- C7 Open carport structures are preferred to garages. Where garages are proposed, they are to be designed to complement the building but also to respect contributory items in the vicinity.
- C8 Suitable garage doors (in order of preference) are: bi-fold, panelled doors, panel lift doors or roller shutter doors. Roller doors are not permitted without a masonry surround structure.
- C9 Loft structures over garages will only be permitted in the few areas which are already characterised by these structures and where:
- a) the form, bulk and scale of the structure will not overwhelm the existing building on the site and on adjoining properties;
  - b) they will not adversely affect the existing streetscape patterns and character; and
  - c) they can be included within a roof space of a pitch that reflects surrounding existing development.
- C10 Accessways, driveways and parking spaces are to be designed to comply with the minimum requirements of AS 2890.1 1993 - Parking Facilities Part 1 Off-Street Car Parking.
- C11 Driveways, parking areas or parking structures are not permitted where their location would adversely affect the existing or long term health of significant trees and vegetation.
- C12 Extensive areas of excavation to facilitate car parking/access are not permitted.

---

### C3.5.9 Site facilities and aerial devices

---

Note: The objectives for these controls are in Section C3.3 Objectives for development.

Note: Solar energy systems such as photovoltaic electricity generating systems, solar hot water systems, or solar air heating systems are addressed in Chapter E6, Section 6.3 Solar Energy Systems.

#### Controls

- C1 Satellite dishes, aerials and similar devices are not to be located on any part of a roof that is visible from the street, the public domain or elevated locations within the area.
- C2 Depending on their design, size and visual impact, satellite dishes, aerials and similar devices may be positioned at the rear of buildings, subject to townscape considerations.
- C3 Television aerials are to be located within the roof area where practicable. If this option is not suitable for reasons such as lack of space, storage or habitation, the aerial to be located on a secondary rear roof rather than attached to the main chimney.
- C4 The design and location of site facilities such as mail boxes and laundry facilities are to be integrated physically and visually with other built elements such as fences, walls, buildings and car parking facilities and to reflect the character of the streetscape.
- C5 Clothes drying facilities are to be located in a secure, open (preferably sunny and breezy) place away from public spaces and screened from public view.

---

### C3.5.10 Acoustic and visual privacy

---

Note: The objectives for these controls are in Section C3.3 Objectives for development.

#### Controls

- C1 Shared walls and floors between dwellings are to be constructed in accordance with the sound transmission and insulation requirements of the Building Code of Australia.
- C2 Bedrooms of one dwelling are not to share walls with living rooms or garages of adjacent dwellings.
- C3 Bedroom windows are to be located at least 3m from streets, shared driveways and parking areas of other dwellings.
- C4 Bedroom areas are to be separated, by way of barriers or distance, from on-site noise sources such as active recreation areas, car parks, vehicle accessways and service equipment areas.
- C5 New dwellings located close to high noise sources, such as busy roads, commercial or retail precincts, are to be designed to locate habitable rooms and private open space away from noise sources.
- C6 Sound attenuation measures such as acoustic glazing and insulation are to be provided for new development close to high noise sources.
- C7 Electrical, mechanical, hydraulic and plant equipment are to be suitably housed so as to not create an 'offensive noise', as defined in the *Noise Control Act 1975*.
- C8 In sensitive locations, such as where commercial, retail or other non-residential buildings adjoin or are adjacent to residential properties, or on busy roads, an acoustic report prepared by a suitably qualified and experienced professional may be required as part of the site and context analysis process.
- C9 Windows in bathrooms, toilets, laundries and storage rooms are to have translucent glazing if they have a direct view to and from rooms and private open space on adjoining and adjacent properties.
- C10 Direct overlooking of the main living areas and private open space areas of adjoining and adjacent properties is to be minimised by the sensitive location of windows, balconies, screening devices and landscaping and the use of opaque glazing.
- C11 Rear balconies are to be designed to provide privacy for the building's occupants and for the occupants of adjoining and adjacent properties. This may require the use of privacy screens to be designed with regard to the architectural style of the building and relevant aspects of the historic context.

- C12 The use of any premises is not to result in:
- a) transmission of vibration to any other premises;
  - b) an offensive noise as defined in the *Noise Control Act 1975*; and
  - c) a sound level at any point on the boundary of the site greater than the levels specified in the relevant Australian Standard.
- C13 Habitable room windows with a direct sightline to the habitable room windows in an adjacent dwelling within 9m are to:
- a) be offset from the edge of one window to the edge of the other by a distance sufficient to limit views into the adjacent windows; or
  - b) have sill heights of 1.7m above floor level; or
  - c) have fixed obscure glazing in any part of the window below 1.7m above floor level.
- C14 Windows and balconies of an upper level dwelling are to be designed to prevent overlooking of the private open space of a lower level dwelling directly below and within the same development.



## C3.6 Contributory items: additional built form controls

This section contains additional built form controls for contributory items to ensure that alterations and additions to contributory items do not have an adverse impact on the heritage significance of the building, the streetscape and the surrounding area.

### C3.6.1 Contributory items

Contributory items are those individual elements within the area that have heritage significance, either as heritage items or contributory items. Contributory items are the buildings and structures, landscape elements, landmarks or other townscape features such as historic kerbs and gutters that contribute to the overall heritage significance of the Watsons Bay HCA.

The contributory items within the Watsons Bay HCA are identified on Map 3 and also listed in the various precincts in Section C3.4 Precincts of this chapter. Heritage items are listed in Woollahra LEP 2014.

The key contributors in the built form include the late 19th and early 20th century single storey cottages, in particular the early weatherboard cottages. The area retains the largest concentration of weatherboard cottages within the Woollahra Local Government Area.

Other contributory items include the historic commercial development fronting Military Road, 1930s residential flat buildings, historic churches and Inter-War period housing. Landmarks are evident throughout the area in various forms including certain buildings, monuments, trees and other natural features. These items also contribute to the significance of the area and, in some cases, its village character.

#### Objectives

- 01 To ensure that heritage items and contributory items are retained and appropriately managed.
- 02 To ensure that new development respects the significance of heritage items and contributory items.
- 03 To ensure that the contributory single storey dwellings/cottages throughout the area, particularly the weatherboard cottages, are retained as contributory items that also enhance the character and village scale of Watsons Bay.
- 04 To ensure that new development respects the scale and character of significant single storey dwellings/cottages.
- 05 To ensure that significant external and internal fabric and spaces within contributory items are retained and appropriately conserved.
- 06 To ensure that significant landmarks are retained and appropriately managed.

## Controls

- C1 Contributory items are to be retained unless overwhelming physical constraints (such as structural integrity, extensive damaged fabric and fire safety requirements) preclude this option.
- C2 The significant fabric of contributory items is to be retained.

Note: Heritage items are identified in Schedule 5 of Woollahra LEP 2014. For the protection of heritage items refer to clause 5.10 of the LEP.

### *Alterations and additions to contributory items*

Alterations and additions to buildings within Watsons Bay have the potential to adversely affect the streetscape and the heritage significance of the area as a whole.

To retain the heritage significance of the conservation area it is important that changes to contributory items does not adversely affect their heritage value.

Alterations and additions to existing buildings are to be designed and sited to ensure the retention of any contributory features or characteristics of the building and the streetscape in which they are located. It should also remain possible to tell the new work from the old on close inspection.

## Objectives

- O1 To ensure that alterations and additions to a contributory item do not adversely affect the character of the building and the streetscape.
- O2 To ensure that alterations and additions to a contributory item that contributes to the significance of the conservation area (i.e. heritage items and contributory items) respect the contributory and/or streetscape values of these items.
- O3 To ensure retention of the existing heights and form of contributory single storey dwellings/cottages.
- O4 To retain existing significant fabric that contributes to the significance of individual buildings and the overall character of the area.
- O5 To restore or reconstruct missing elements, where possible.

### *Siting and alignment*

- C1 Additions to buildings that are contributory items are to respect their height, form, character and materials.
- C2 Additions to the front of contributory items are not permitted.
- C3 Additions to a single storey dwelling/cottage are to occur at the rear and are to be unobtrusive when viewed from the street (Figures 172 and 174).

- 
- C4 Additions to the side of contributory items, including cottages, may be permitted in rare situations where there is insufficient space at the rear of the building and the addition would respect and enable interpretation of the original form of the existing building.
  - C5 Side additions to significant single storey dwellings/cottages are to be located towards the rear of the dwelling and are to be screened with vegetation (Figure 173).

#### ***Height of additions***

- C1 The height of contributory items, as they present to the street, is not to be increased. This applies irrespective of whether the building is single storey or whether it adjoins or is located between higher buildings.
- C2 The height of additions is to be no greater than that of the existing building unless the addition is a pavilion form and the upper storey of the rear form is not visible when viewed from the public domain, and the additions do not adversely affect the appearance and setting of the existing building, nor its streetscape contribution.

#### ***Form and character***

- C1 Attic conversions within contributory items, including cottages, are only permitted where the upper floor can be contained wholly within the existing roof space without change to the roof pitch (Figure 174). Dormer windows may be permitted in these circumstances, but only if located in the rear roof plane.
  - C2 Two storey rear extensions to single storey dwellings/cottages may be permitted where:
    - a) the land slopes to the rear and can provide for the additional storey as a basement level;
    - b) the ridgeline of the addition is not to extend above the height of the ridgeline of the existing building; and
    - c) the roof form is to relate to the original existing roof form (Figure 172).
  - C3 The form (massing and building arrangement) of additions is to complement and not compete with the existing building. Additions are to generally match the roof pitch, form and proportions of the existing building. (Skillion or 'lean-to' additions may be appropriate at the rear of contributory items, as this is a traditional form of building extension.) (Figure 172 & 174).
  - C4 Additions to contributory items are to complement but not mimic their character (i.e. architectural design treatment or 'style').
  - C5 Components/elements that contribute to the significance of the building or the conservation area are not to be altered; in particular, those visible from the streetscape.
  - C6 The removal of unsympathetic alterations to existing buildings is encouraged, particularly when further work is undertaken.
  - C7 Internally, room layouts of original portions of contributory cottages are to be retained.
  - C8 Changes to the roof pitch (i.e. slope) of contributory items are not permitted.
-

- C9 The eaves height of contributory items is not to be raised; for example, by constructing the roof at a higher level in order to accommodate an additional storey.
- C10 Contributory items are not to be 'restyled'; i.e. their architectural style is not to be changed.
- C11 Additions are not to alter original roof forms of contributory items.

***Verandahs and balconies***

- C1 The enclosure or infilling of existing verandahs or balconies is not permitted.
- C2 Original verandahs and balconies are not to be altered except for the reinstatement of original details and the reversal of unsympathetic alterations.
- C3 Verandahs, balconies and shop awnings may be reinstated on street front elevations where evidence shows that they have previously existed. They should be reconstructed to their former appearance in terms of materials and details.

***Materials and details***

- C1 The removal of original materials, details and decorative elements is not permitted unless they are in poor condition. If removed, they are to be replaced using the same or similar materials, details and decorative elements.
- C2 Previously unpainted brick or stone walls/surfaces are not to be painted, rendered or bagged.
- C3 Mortars for repointing and repair are to match the colour, profile of joint, texture and mix of the original mortar (usually a mixture of lime, putty and sand).

***Dormers***

- C1 Dormer windows are not to be added to street front and side elevations unless documentary evidence shows that an original dormer or dormers existed in these locations as part of the original design.
- C2 A dormer may be located within the rear slope of the main roof subject to consideration being given to its visual impact when viewed from the public domain, its impact on the building's significance and, where the building forms part of a group, the impact on the group's significance.

- C3 More than one dormer window may be located within the rear slope of the main roof subject to the width of the roof being greater than 6m and subject to consideration of the impact on the building's significance and appearance.
- C4 The overall height of the dormer window, including the pediment, must be below the main roof ridgeline by at least 300mm.
- C5 The design, proportions and materials of new dormers where permitted, are to be based on traditional models, appropriate to the architectural style of the building and the building's context and have the following characteristics:
  - a) pediment infill for dormer windows must only be weatherboards;
  - b) the cheeks may be covered in weatherboard or in corrugated profile steel sheeting, depending on the building's architectural style and context;
  - c) windows shall be traditional double hung windows or pivoting wings with casement stays; and
  - d) dormers are not to incorporate balconies.

**FIGURE 172** Rear additions to single storey dwellings

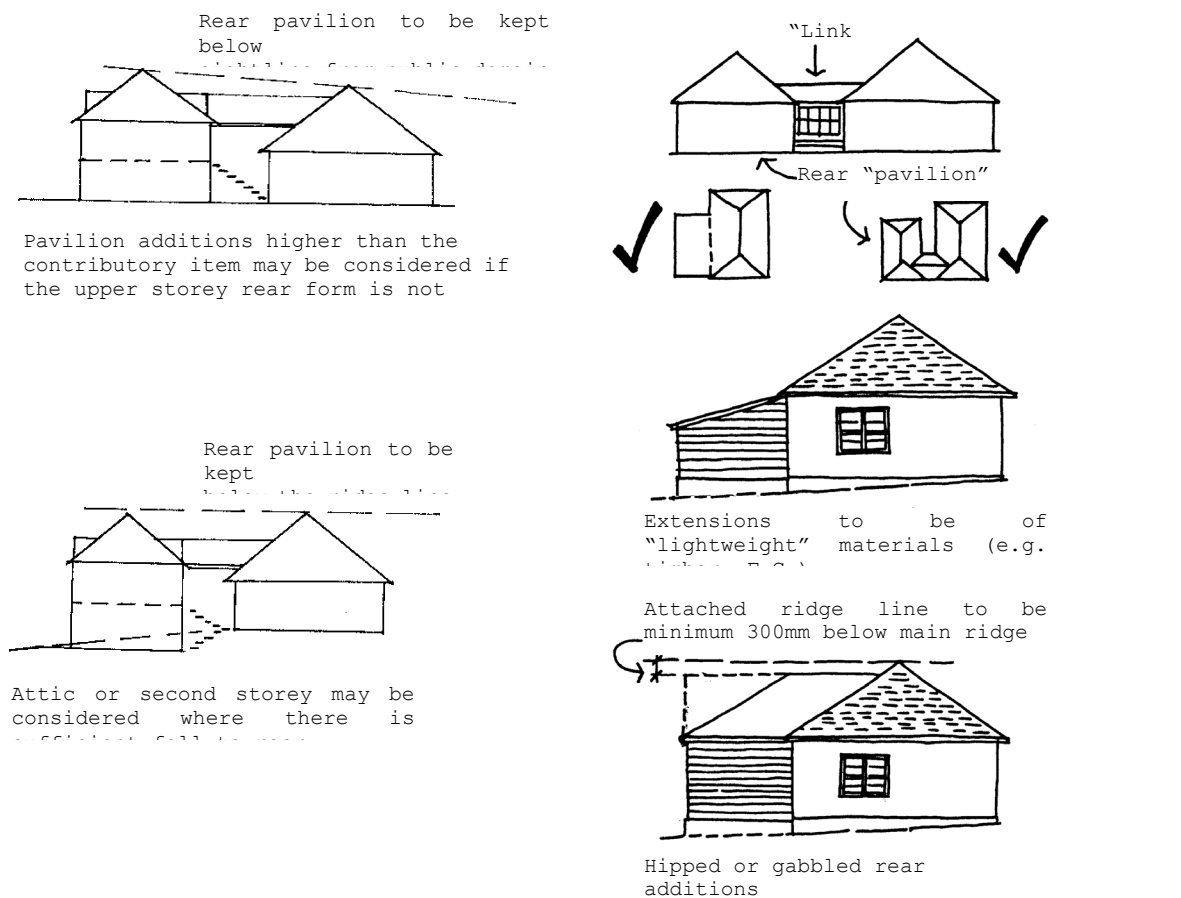


FIGURE 173 Side additions to cottages are to be towards the rear

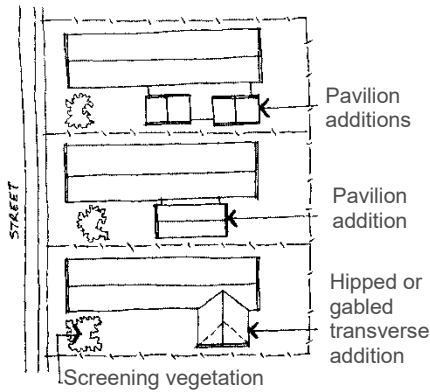
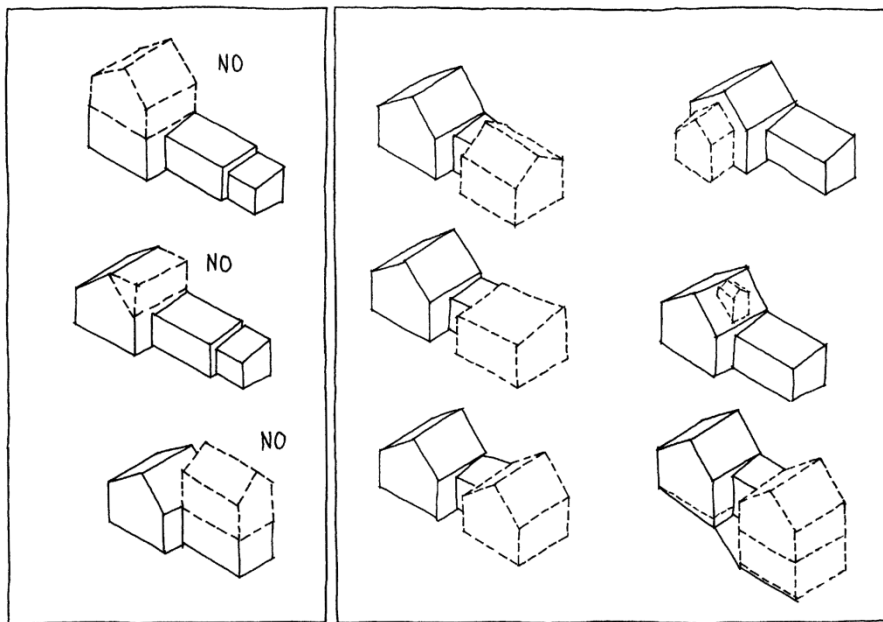


FIGURE 174 Rear additions to significant single storey dwellings/cottages



### C3.6.2 Inter-War residential flat buildings

Residential flat buildings and multi dwelling housing in Watsons Bay generally consist of small two, three and four storey buildings dating from the 1930s to 1950s, taller buildings dating from the 1960s to 1970s, and the infill buildings of the 1990s.

Contributory buildings identified in Clause 3.4 Precincts include some Inter-War flat buildings.

## **General**

### **Objectives**

- O1 To mitigate the effects of intrusive residential flat building and multi dwelling housing development.
- O2 To encourage redevelopment or modification of intrusive development.
- O3 To ensure that parking does not detract from the character of the streetscape.

### **Controls**

- C1 Redevelopment or modification of intrusive development must be to a design that is appropriate to the historic context.
- C2 Alterations and additions that reverse any unsympathetic works is encouraged.
- C3 Alterations and additions to intrusive development must be an appropriate response to the historic streetscape and mitigates intrusiveness.

## ***Inter-War Residential Flat Buildings***

### **Objectives**

- O1 To conserve and maintain Inter-War flat buildings in Watsons Bay.
  - O2 To ensure that the significant characteristics of Inter-War residential flat buildings contributing to the character of the area are retained and protected.
  - O3 To conserve the principal street elevations and the character of the Inter-War flat buildings.
  - O4 To ensure that the character of original roofscapes, including key elements such as chimneys, is maintained.
  - O5 To ensure that alterations and additions to the roofs are discreet and do not detract from the original character, proportions or key elements.
  - O6 To conserve the established garden settings, including significant elements and features.
  - O7 To ensure that parking does not detract from the character of the streetscape.
  - O8 To ensure that external materials, details and finishes respect and complement the original building.
  - O9 To ensure that works to balconies and verandahs to rear or side elevations do not detract from the character and form of Inter-War flat buildings.
  - O10 To ensure that fences, gates and mailboxes are consistent with the character of Inter-War flat buildings.
-

- 
- O11 To ensure that internal additions, alterations and repairs retain and respect internal common areas and significant internal character elements.
  - O12 To ensure that the installation and maintenance of security devices does not detract from the character and form of Inter-War flat buildings.
  - O13 To ensure that additions and alterations for fire upgrading and safety are discreet, and retain and respect the original and significant building fabric.
  - O14 To ensure that ancillary development does not detract from the style and character of Inter-War flat buildings and their settings.
  - O15 To promote restoration and reconstruction works to restore significance.

### Controls

- C1 Significant and/or original forms, details, fabrics, materials or finishes of the principal building elevations are to be restored or reconstructed.
- C2 Changes to the significant forms, details, materials or finishes of the principal building elevations are sympathetic to the style and period of the building.
- C3 Alterations and additions do not impact on the overall form and character of the building, and are not visually prominent from the public domain.
- C4 Additions are limited to undercroft areas, roof spaces and the provision of balconies.
- C5 Alterations and additions are no higher than the existing roof level, and generally retain the original roof form of the building.
- C6 External windows and doors are repaired or replaced to match the style, materials and finishes of the original building.
- C7 Existing original fanlights and other openings are retained and sealed from behind, if necessary.
- C8 Original leadlight, glass blocks, etched and patterned glazing are retained and conserved.
- C9 Existing original external and internal doors and door hardware are retained and upgraded rather than replaced.
- C10 New additional security elements are in character with the building. Security bars are:
  - a) fitted internally;
  - b) respect the existing glazing patterns; and
  - c) painted in a dark recessive colour.
- C11 Original verandahs and balconies to the principal elevation of the building are not enclosed, glazed, or otherwise altered, except to reinstate original detailing.
- C12 New verandahs and balconies are allowed to the rear or side elevations only if they:
  - a) respect the character of the existing building; and



- 
- b) are sympathetically integrated with the character and form of the building.
- C13 Alterations to improve accessibility (including lifts, ramps and stairs) are sympathetically integrated with the original building and retain the original character and design of the building and landscape areas.
- C14 Materials are similar in type and finish to those on the original building or sympathetically integrate with the fabric of the building.
- C15 Original face brickwork, terracotta or decorative concrete panels must not be painted, rendered or coated.
- C16 Dormer windows or skylights are not visually prominent from the public domain or the principal elevations of the building. Skylights are flush with the roof surface.
- C17 Original chimneys and their details are retained.
- C18 Privacy screens are discreet and do not impact on the overall character of the building.
- C19 Protruding shade structures, including awnings and canopies, are not located on the principal building elevations.
- C20 The roof maintains traditional roofing materials of the area, such as glazed terracotta tiles. Any replacement or repair matches the original roofing in type, profile, colour and materials. Concrete roofing tiles and corrugated metal roofing are not appropriate.
- C21 Internal common areas and significant character elements are retained. This includes: entry doors, foyer areas and fittings, mailboxes, noticeboards, staircases, balustrades, wall details, light fittings, internal doors and the like.
- C22 New lifts are designed and located so that the addition:
- a) is located outside the principal building form, if practical; and
  - b) does not require significant alterations to existing common areas.
- C23 Unsympathetic additions and modifications to the building, and its grounds, are to be removed and replaced with sympathetic works, or reinstatement of original forms and matching fabric.
- C24 Services upgrading and fire safety works must minimise adverse visual impact and damage to original building fabric.
- C25 Alarm bell boxes and the like, are not attached to the principal building elevations.
- C26 New or upgraded services are discreetly and sensitively located to minimise visual impact. They are located within existing ducts, behind cornices or bulkheads or within external lightwells that are not visually prominent. Wiring or other services are housed in concealed conduits.
- C27 Original timber staircases are retained and smoke isolated, if necessary.
- C28 Where the height of the original stair balustrades is to be modified –the modification is discreet and sympathetically integrated with the existing stair balustrade.
-

- 
- C29 Stair treads applied to existing stairs are discreet.
  - C30 Emergency and exit lighting is incorporated into existing original light fittings, where practical.
  - C31 Smoke and/or thermal detectors are discreetly located and do not impact on decorative plaster cornices and ceilings.
  - C32 Car parking and garage structures are located at the rear, with access from the rear lane or side driveway.
  - C33 Original fencing, gates and mailboxes are retained and conserved.
  - C34 New ancillary development:
    - a) is smaller in scale than the principal building;
    - b) is not located between the principal building and the street front, and generally located at the rear behind the principal building;
    - c) is constructed in a style, form, materials and finishes that complement the principal building;
    - d) is single storey with a maximum clear internal height of 2.4m; and
    - e) is sympathetic in scale and style to traditional forms of ancillary structures.
  - C35 Characteristic front gardens, and their elements, are retained with minimal alteration.
  - C36 Structures erected in the front garden do not significantly reduce or compromise the landscaped area or key elements and features.
  - C37 New fences and gates to the front building alignment must complement the streetscape and the existing building.
  - C38 Mailboxes are discreetly located and do not impact on the character of the building.

### C3.6.3 Timber buildings

---

Watsons Bay retains the largest concentration of timber weatherboard buildings within the Woollahra local government area. Weatherboard buildings provide evidence of the early village of Camp Cove and contribute to the area's heritage values.

All forms of weatherboard buildings contribute to the diverse character of Watsons Bay streetscapes and the aesthetic value of the conservation area. Timber buildings are also significant because of their increasing rarity and historical association with the early fishing village of Camp Cove that is protected through the listing of the Watsons Bay Heritage Conservation Area.

Weatherboard buildings are vulnerable to change and many have been modified over time, are in a deteriorated condition or suffer from structural instability. Despite these changes, weatherboard buildings in Watsons Bay continue to make an important contribution to the character of the conservation area and are to be conserved.

---

## Objectives

- O1 To retain and conserve timber buildings and their setting.
- O2 To retain, restore and conserve the special characteristics and details of timber buildings.
- O3 To restore and reconstruct missing elements of the principal building form within the street front zone.
- O4 To retain and conserve significant side and rear forms of timber buildings.
- O5 To retain, restore and promote the significance, contribution and relationship of a timber weatherboard building within the context of the conservation area.
- O6 To ensure that additions and alterations for fire upgrading and safety are discreet, and retain and respect significant building and its fabric.

## Controls

- C1 Additional storeys are not permitted to the principal building form of timber buildings.
- C2 When works are proposed to the principal building form or original significant elevations visible from the street or lane, Council strongly encourages, and may require, restoration or reconstruction of missing elements appropriate to the architectural style of the building or reversal of uncharacteristic elements where:
  - a) balconies or verandahs have been enclosed and details such as balustrade panels, rails, columns, friezes and fringes have been removed;
  - b) original door or window types and patterns have been removed;
  - c) roof cladding is in a unsympathetic material;
  - d) details are missing from chimneys; and
  - e) inappropriate reconstruction of period detail and elements has occurred.

Note: Reconstruction and restoration may be guided by traditional models and physical or documentary evidence of an earlier state of the building or architectural style.
- C3 Existing setbacks from the front and side boundaries of the principal building form are to be retained.
- C4 Alterations and additions to the rear of buildings must not dominate or compete with the form, height, proportions or scale of the timber building.
- C5 Where structural stabilisation of a timber building is necessary, a sympathetic structural solution that ensures the conservation of as much original external and internal fabric as possible is required.
- C6 Where alterations to timber buildings are required to meet the provisions of the Building Code of Australia, materials must be consistent with traditional materials and finishes.

- C7 No parking is permitted under or within the principal building form of a dwelling.
- C8 Fire upgrade and access works must be done sympathetically and avoid removal of significant fabric.

---

## C3.7 Public domain

The public domain describes those areas of land owned and/or managed by Council or other public authorities. The public domain includes roadways, gutters, kerbs, footpaths, street name inlays, retaining walls, landscaped verges and reserves, natural landforms and other elements located beyond private property boundaries.

The public domain plays a significant role in determining the overall character of the Watsons Bay HCA. Development must have regard to the impact on the public domain and not unreasonably compromise key elements of the public domain.

In addition to the following principles, the general development objectives and controls in Section C3.3 Objectives for development also apply within the public domain.

### Objectives

- 01 To ensure that existing elements of the public domain, which give Watsons Bay its distinctive character, are conserved.
- 02 To ensure that new elements are appropriately designed and managed to retain and enhance the character of the area and its precincts.
- 03 To ensure that new elements within the public domain are discreet and unobtrusive in terms of colours, materials and location.

### C3.7.1 Beaches, waterfront and public access

---

#### Beaches

- C1 The natural qualities of the beaches should be retained and rock platforms protected.
- C2 Direct public access should be retained to the beaches.
- C3 Views to the beaches from the water should not be obscured by a proliferation of structures such as wharves, jetties, boat ramps, clubhouses, landings and the like. The cumulative effects of such structures should also be assessed when new structures are being considered.

#### Camp Cove Beach



#### Waterfront

- C4 Public promenades should be retained along the waterfront and from Marine Parade to The Gap through Robertson Park.
- C5 Views from the public domain to the waterfront or the harbour should not be obscured by structures such as kiosks, public facilities such as telephone booths, wharves, jetties, and the like. The cumulative effects of such structures should also be assessed.
- C6 Continuity of public access to the waterfront and along the promenade must be retained and, where possible be enhanced.

#### North end of Marine Parade



### Public access

- C7 Continuous public access (including disabled access) linkages should be retained and created to the harbour foreshore.
- C8 Opportunities should be retained and created for pedestrian circulation throughout the Watsons Bay area.
- C9 The pedestrian network of public stairways and promenades has historic significance and should be retained, recognised and enhanced.

### Pathway and steps, Sydney Harbour National Park (Inner South Head)



### C3.7.2 Landscape elements and kerbs and gutters

#### Landscape elements

- C1 Significant landscape elements such as cultural plantings (street trees and park vegetation), sandstone retaining walls, and steps should be retained and conserved in situ using appropriate conservation methods.
- C2 New retaining walls should be of similar design to traditional retaining walls in the area in terms of their character, height and materials. Appropriate materials may include sandstone and face brick.
- C3 Materials for new steps should be concrete or sandstone, depending on their function and the significance of their location.
- C4 New steps and ramps should be designed and located to enhance amenity and opportunities for vistas.

Cultural plantings on Cliff Street



Sandstone retaining wall along Salisbury Street



#### Kerbs and gutters

- C5 Meaningful sections of original sandstone kerbs and gutters should be retained in situ to enhance interpretation. New paving should not adversely impact on the fabric or setting of sandstone kerbs and gutters.
- C6 Kerbs and gutters that incorporate street names should be retained.
- C7 Damaged original sandstone kerbs and gutters should be restored where possible or replaced with new sandstone kerbs and gutters.



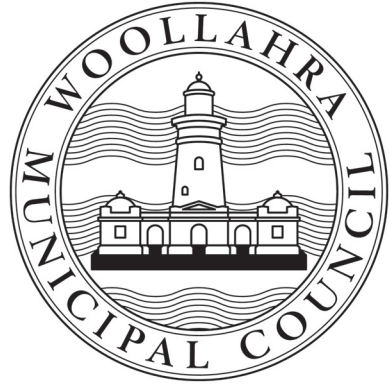
- 
- C8 New kerb and guttering should be constructed in similar materials and details to that of original fabric.
  - C9 New sandstone kerbing should be used where appropriate to the context and is to be detailed to match the existing kerbing. Where concrete kerbs are to be used, preference should be for precast segmental elements.
  - C10 Original kerb alignments should be retained to preserve the character of the streets.
  - C11 Screen planting (using appropriate species) should be provided to off-street public car parking areas to soften their visual impact, increase shade and provide a visual barrier to adjacent residential development.

Camp Street name incorporated into gutter



Sandstone guttering





## Part D ► Business Centres

WOOLLAHRA DEVELOPMENT CONTROL PLAN 2015



# Chapter D1 Neighbourhood Centres

Part D ▶ Business Centres

CHAPTER D1 APPROVED ON 27 APRIL 2015  
AND COMMENCED ON 23 MAY 2015

Last amended on 31 May 2024



# Chapter D1 ► Neighbourhood Centres

## Contents

<b>D1.1</b>	<b>INTRODUCTION</b>	<b>1</b>
D1.1.1	Land where this chapter applies	1
D1.1.2	Development to which this chapter applies	1
D1.1.3	Objectives	3
D1.1.4	Relationship to other parts of the DCP	3
D1.1.5	How to use this chapter	4
<b>D1.2</b>	<b>HOPETOUN AVENUE, VAUCLUSE</b>	<b>6</b>
D1.2.1	Centre character statement	6
D1.2.2	Desired future character	7
D1.2.3	Objectives and controls	8
<b>D1.3</b>	<b>SOUTH HEAD ROUNDABOUT, VAUCLUSE</b>	<b>11</b>
D1.3.1	Centre character statement	11
D1.3.2	Desired future character	13
D1.3.3	Objectives and controls	14
<b>D1.4</b>	<b>VAUCLUSE SHOPPING VILLAGE, VAUCLUSE</b>	<b>15</b>
D1.4.1	Centre character statement	15
D1.4.2	Desired future character	17
D1.4.3	Objectives and controls	17
<b>D1.5</b>	<b>PLUMER ROAD, ROSE BAY</b>	<b>21</b>
D1.5.1	Centre character statement	21
D1.5.2	Desired future character	23
D1.5.3	Objectives and controls	24
<b>D1.6</b>	<b>O’SULLIVAN ROAD, ROSE BAY</b>	<b>27</b>
D1.6.1	Centre character statement	27
D1.6.2	Desired future character	30
D1.6.3	Objectives and controls	30
<b>D1.7</b>	<b>STREATFIELD ROAD</b>	<b>31</b>
D1.7.1	Centre character statement	31
D1.7.2	Desired future character	33
D1.7.3	Objectives and controls	33
<b>D1.8</b>	<b>BELLEVUE HILL SHOPS</b>	<b>37</b>
D1.8.1	Centre character statement	37
D1.8.2	Desired future character	39
D1.8.3	Objectives and controls	40
<b>D1.9</b>	<b>MANNING ROAD, WOOLLAHRA</b>	<b>44</b>
D1.9.1	Centre character statement	44
D1.9.2	Desired future character	45
D1.9.3	Objectives and controls	46

---

**D1.10 DARLING POINT ROAD, DARLING POINT ..... 49**  
D1.10.1 Centre character statement..... 49  
D1.10.2 Desired future character ..... 51  
D1.10.3 Objectives and controls ..... 51

## D1.1 Introduction

This is Chapter D1 of the Woollahra Development Control Plan 2015 (DCP), Part D Business Centres.

This chapter contains controls for nine centres, zoned E1 Local Centre under Woollahra Local Environmental Plan 2014 (Woollahra LEP 2014).

This chapter seeks to ensure that development has regard to its context and is compatible with the desired future character of each centre as described in this chapter.

### D1.1.1 Land where this chapter applies

This chapter applies to the following centres, as identified on Map A (see next page):

- ▶ Hopetoun Avenue, Vaucluse
- ▶ South Head Roundabout, Vaucluse
- ▶ Vaucluse Shopping Village, Vaucluse
- ▶ Plumer Road, Rose Bay
- ▶ O'Sullivan Road, Rose Bay
- ▶ Streatfield Road, Bellevue Hill
- ▶ Bellevue Hill Shops, Bellevue Hill
- ▶ Manning Road, Woollahra
- ▶ Darling Point Road, Darling Point.

### D1.1.2 Development to which this chapter applies

This chapter applies to development that requires development consent.

A key objective of the E1 zone is to provide a range of small-scale retail, business and community uses that serve the needs of people who live or work in the surrounding neighbourhood.

The E1 zone permits a limited range of retail premises including shops, restaurants and cafes, take-away food and drink premises; the zone also permits business premises, office premises, community facilities and shop top housing. (Refer to Woollahra LEP 2014 for all the types of development permitted in the zone.)



**MAP A** Land where Chapter D1 applies



---

### D1.1.3 Objectives

---

The objectives of this chapter are:

- 01 To support the long term retail health of the neighbourhood centres.
- 02 To facilitate development in a way that reflects desired future character objectives for each centre.
- 03 To preserve the small shop character of each centre.
- 04 To ensure a high standard of architectural and landscape design.
- 05 To ensure that development enhances the visual quality and identity of the centre through well considered design, high quality materials and facade colours that do not dominate the street.
- 06 To ensure that the design and siting of development is compatible with the surrounding built form.
- 07 To encourage active ground floor uses that contribute to the vitality of the centre.
- 08 To encourage a complementary mix of small scale retail, business, office and residential uses compatible with the desired future character of the centre.
- 09 To facilitate people living in mixed use developments in the centres, and provide for good residential amenity.
- 010 To provide a range and mix of dwellings that are compatible with shops and/or business and office uses.
- 011 To minimise adverse impacts of development on the amenity of adjoining and neighbouring properties.
- 012 To retain significant views and vistas.
- 013 To improve the amenity of public domain and pedestrian safety.

---

### D1.1.4 Relationship to other parts of the DCP

---

This chapter is to be read in conjunction with the other parts of the DCP that are relevant to the development proposal, including:

- ▶ Part D: Chapter D3 General Controls for Neighbourhood and Mixed Use Centres.
- ▶ Part E: General Controls for All Development - this part contains chapters on Parking and Access, Stormwater and Flood Risk Management, Tree Management, Contaminated Land, Waste Management, Sustainability, Signage and Adaptable Housing.
- ▶ Part F: Land Use Specific Controls - this part contains chapters on Child Care Centres, Educational Establishments, Licensed Premises and Telecommunications.

---

### D1.1.5 How to use this chapter

---

The primary controls for the neighbourhood centres are contained in two chapters:

- ▶ Chapter D1 Neighbourhood Centres; and
- ▶ Chapter D3 General Controls for Neighbourhood and Mixed Use Centres.

#### Chapter D1 Neighbourhood Centres

Each section in this chapter represents an individual centre. Applicants need only refer to the particular centre that is relevant to their site.

The controls for each centre comprise the following elements:

- ▶ map showing the extent of the centre;
- ▶ centre character statement, providing a brief description of the centre;
- ▶ desired future character, establishing the direction and outcomes to be achieved through development in the centre; and
- ▶ table of objectives and controls relating to uses, built form, amenity, the public domain etc. The controls represent specific ways in which a development proposal can meet the objectives. A street section diagram is also provided for some centres to illustrate certain controls.

The objectives and controls in this chapter are to be read in conjunction with the controls in Chapter D3 General Controls for Neighbourhood and Mixed Use Centres.

#### Chapter D3 General Controls for Neighbourhood and Mixed Use Centres

The general controls apply to all E1 zoned land addressed in Chapter B1, regardless of the centre in which the land is located.

Development is required to fulfil the relevant requirements of all general controls. Unless otherwise indicated, where there is a disparity between the objectives and controls in Chapters D1 and D3, the centre specific objectives and controls in this chapter take precedence over the general controls.

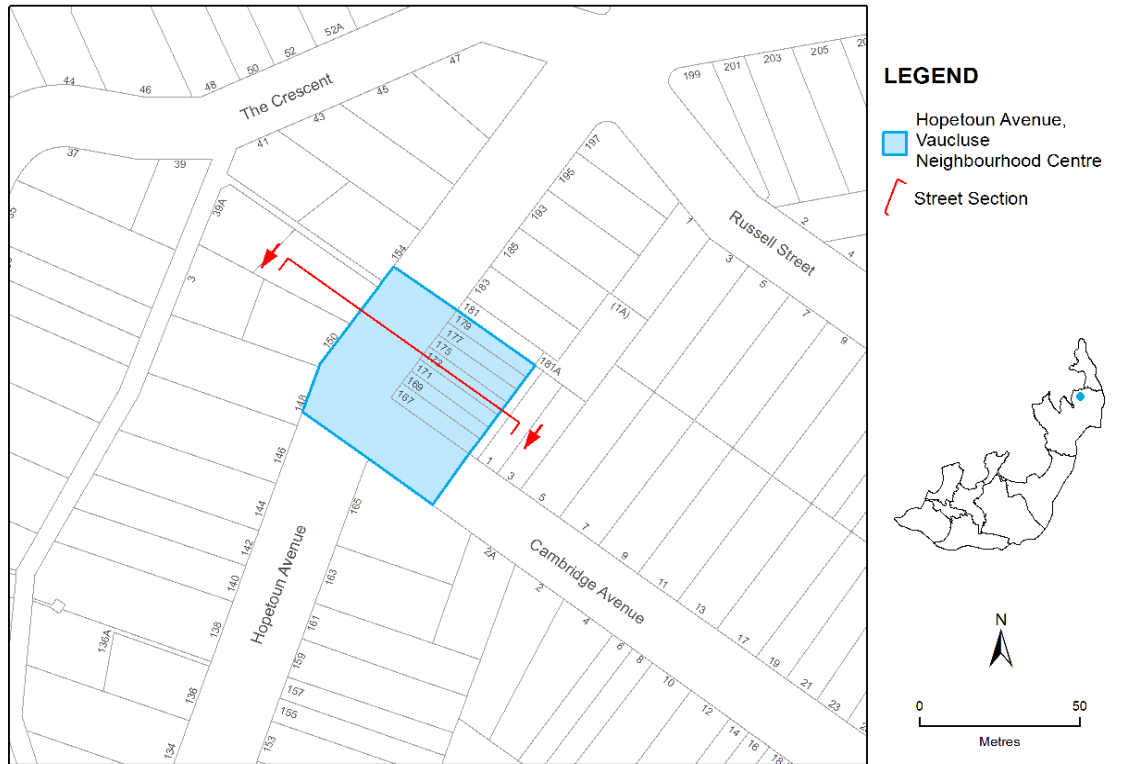
Applicants need to demonstrate how their development fulfils the relevant objectives and preserves or enhances the important character elements for the centre, having particular regard to:

- ▶ surrounding building height, bulk and scale;
- ▶ any predominant architectural styles, roof forms, materials and colours;
- ▶ prevailing building lines;
- ▶ existing and proposed uses;
- ▶ landscape and vegetation features;
- ▶ topography;
- ▶ view corridors;

- ▶ pedestrian access and amenity;
- ▶ cumulative traffic and parking impacts;
- ▶ interface between the private and public domain; and
- ▶ adjacent residential areas and heritage conservation areas.

## D1.2 Hopetoun Avenue, Vaucluse

MAP 1 Hopetoun Avenue centre map



### D1.2.1 Centre character statement

The Hopetoun Avenue neighbourhood centre is located on an elevated slope on Hopetoun Avenue, at the corner of Cambridge Street Vaucluse; it is within a kilometre of Watsons Bay.

This is a relatively small centre, comprising a row of seven shop top premises, including a neighbourhood shop. Other businesses currently located in the centre are a pool shop and food catering business. Some of the ground floor shopfronts do not provide active uses, and one of these appears to contain a residential use. These inactive shopfronts detract from the role of the centre, its vitality and amenity.

#### Historical development of the area

Land in and near the centre was subdivided in the early 1900s. Access to Vaucluse was by ferry landing at nearby Parsley Bay or near Gibson Reserve. Larger waterfront blocks were released and built upon first. Substantial housing development followed in the 1920s and 1930s, whilst Vaucluse Council resisted residential flat building in the municipality. The nearby Vaucluse Primary School opened in 1925.

### Built form

The centre comprises two groups of buildings at 167-171 and 173-179 Hopetoun Avenue. These are a short row of Inter-war two storey shop top housing with some recent three storey additions. The shop top buildings are all built to the street alignment with continuous awnings and parapets. The building stock around the centre is represented by larger detached residential dwellings of generally high quality and set in generous gardens.

### Public parks and community facilities

Gibson Park, Parsley Bay Reserve and Vaucluse Public School are located close to the centre.

### Public domain

The asphalt footpath and minimal street furniture provide a basic standard of pedestrian amenity.

### Access and circulation

The centre is on the Watsons Bay bus route, although most shoppers would use car transport or arrive on foot from nearby residences. On street parking is adequate for the low levels of retail activity.

### Views and aspect

The centre enjoys a pleasant elevated north-westerly aspect. The church steeple of Our Lady Star of the Sea on New South Head Road at Watsons Bay may be seen when looking north-east from the upper levels of the shop top housing in the centre.

### Hopetoun Avenue



## D1.2.2 Desired future character

The Hopetoun Avenue neighbourhood centre is a small centre located within a continuous row of shop top housing. The Inter-war buildings 167-171 and 173-179 Hopetoun Avenue make an

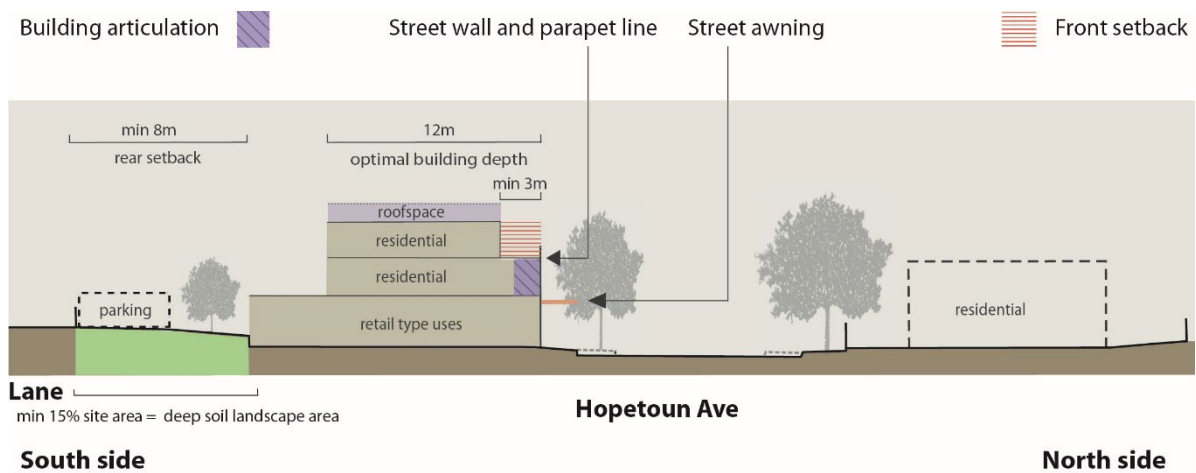
attractive contribution to the streetscape, exhibiting a cohesive street wall, strong character elements, and establishing the scale and character of the centre. Redevelopment within the centre should protect the fabric and character of these buildings.

The centre is located within an established residential area and there is great potential for the centre to become more of a community hub. The ground floor uses are to establish active frontages with small scale shops and services, particularly those that provide for the daily convenience needs of surrounding residents, such as a cafe, bakery and grocers. Residential uses will occur on the upper levels.

### D1.2.3 Objectives and controls

The street diagram illustrates some of the controls, and is to be read in conjunction with the table of objectives and controls below. Note, the maximum building height and FSR are in Woollahra LEP 2014.

**FIGURE 1** Hopetoun Avenue street section



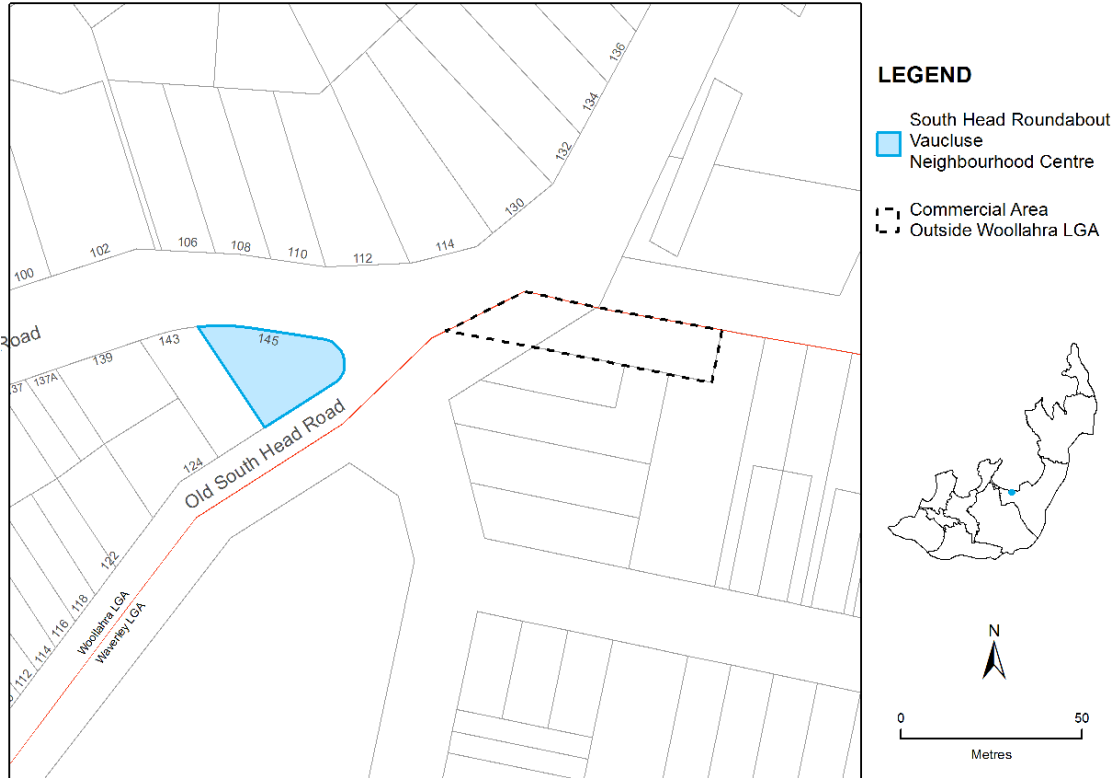
Objectives		Controls	
O1	To provide uses that are consistent with the desired future character of the centre.	C1	Development supports the adaptive re-use of existing shop top units.
		C2	The ground level contains active uses, preferably shops, and cafés including outdoor dining, that meet the daily convenience needs of the local community.
		C3	Residential uses located above street level in the form of shop top housing.
O2	To protect the fabric and character of the existing Inter-war shop top buildings.	C4	Development does not include infill of original verandahs.
		C5	Development includes a continuous solid suspended awning over the public footpath and along the return into Cambridge Street.
O3	To retain a coherent streetscape with a consistent street wall and parapet line.	C6	Development is a maximum of three storeys.
		C7	Development retains two storeys built to the street alignment, as well as the continuous parapet line.
		C8	Development on the third level is setback from the street boundary as shown.
		C9	Development does not include vehicular access off Hopetoun Avenue.
O4	To encourage good building design and limit building bulk.	C10	Building articulation at the street alignment is in the form of recessed balconies or loggia only. Elsewhere it may be in the form of verandahs, balconies, loggia or wall offsets.



Objectives		Controls	
05	To provide for the amenity of occupants and adjoining properties.	C11	The building depth for storeys above the ground floor level is generally not more than 12m.
		C12	The building is setback from the rear boundary by at least 8m.
		C13	At least 15% of the site is provided as deep soil landscaped area.
06	To improve the pedestrian environment.	C14	Development includes advanced tree planting as a formal row of shade trees.
07	To encourage footpath dining in areas with good solar access.	C15	Footpath dining areas receive a minimum 2 hours solar access each day.

## D1.3 South Head Roundabout, Vaucluse

MAP 2 South Head Roundabout centre map



### D1.3.1 Centre character statement

South Head Roundabout shops are located on New South Head Road at the junction with Old South Head Road. These shops are located in an Inter-war building which provides a significant landmark at this broad open intersection. The centre provides a small selection of specialty shops and personal services, such as a hair dresser, clothes alterations, art gallery, homewares shop and fitness studio. Residential uses occur on the upper level.

This centre is located across the road from a small group of two shopfronts currently used as a café and bakery, located in the Waverley Council area. The connections and relationship between these centres are compromised by the relatively busy roundabout at the intersection New South Head Road and Old South Head Road.

---

### Historical development of the area

New South Head Road was constructed as a link to Watsons Bay during the 1830s. The South Head Cemetery was dedicated in 1845. Land in and near the centre was subdivided in the early 1900s at the same time as a tramline along New South Head Road was introduced. However, substantial housing development did not proceed until the 1920s and 1930s. Vaucluse Council resisted residential flat building in the municipality, but there were some Inter-war flat buildings built on New South Head Road near the centre. Vaucluse High School adjacent to the centre opened in 1960, the same year that the tram service ceased.

### Built form

This neighbourhood centre is contained in a single well conserved Inter-war building that includes a sympathetic third floor addition for residential use. The building addresses the corner at the roundabout and New South Head Road, and has a continuous parapet line and a series of canvas awnings. Across the roundabout in the Waverley Municipality is a mix of 20th century architecture of varying quality and scale, and a recent five storey residential flat building facing Christison Park.

### Public parks and community facilities

Christison Park and the South Head Cemetery are both within 100m of the site. Christison Park offers recreational opportunities in proximity to the neighbourhood centre.

### Public domain

The standard asphalt footpath pavement and the exposed corner situation on the roundabout afford little pedestrian amenity.

### Access and circulation

The centre is well located on bus routes operating on both New South Head Road and Old South Head Road. It is accessible by car and provides a limited number of off-street car parking spaces. The speed and volume of vehicles moving through the roundabout compromise pedestrian amenity and safety.

### Views and aspect

To the north-east, beyond the roundabout, the centre has a distant outlook to Christison Park. To the north, harbour views are afforded from the upper storeys of the Inter-war building.

## New South Head Road and Old South Head Road



### D1.3.2 Desired future character

The South Head Roundabout neighbourhood centre will continue to be a relatively small centre that provides a range of specialty shops and personal services that service the local community, and supplement the nearby Vaucluse village which provides a greater range of local convenience shops and services. Office and residential uses will occur on the upper levels.

This neighbourhood centre is located in an Inter-war building which provides a strong and visually attractive landmark at this major intersection of New South Head Road and Old South Head Road. The building is a good intact example of the ocean liner style and it is important that the building and key elements, such as the continuous parapet line, stay intact. Although the original face brickwork has been painted and the original awning has been removed, the consistent canvas awnings and under-awning signage make a positive contribution to the streetscape and this visual unity should be retained.

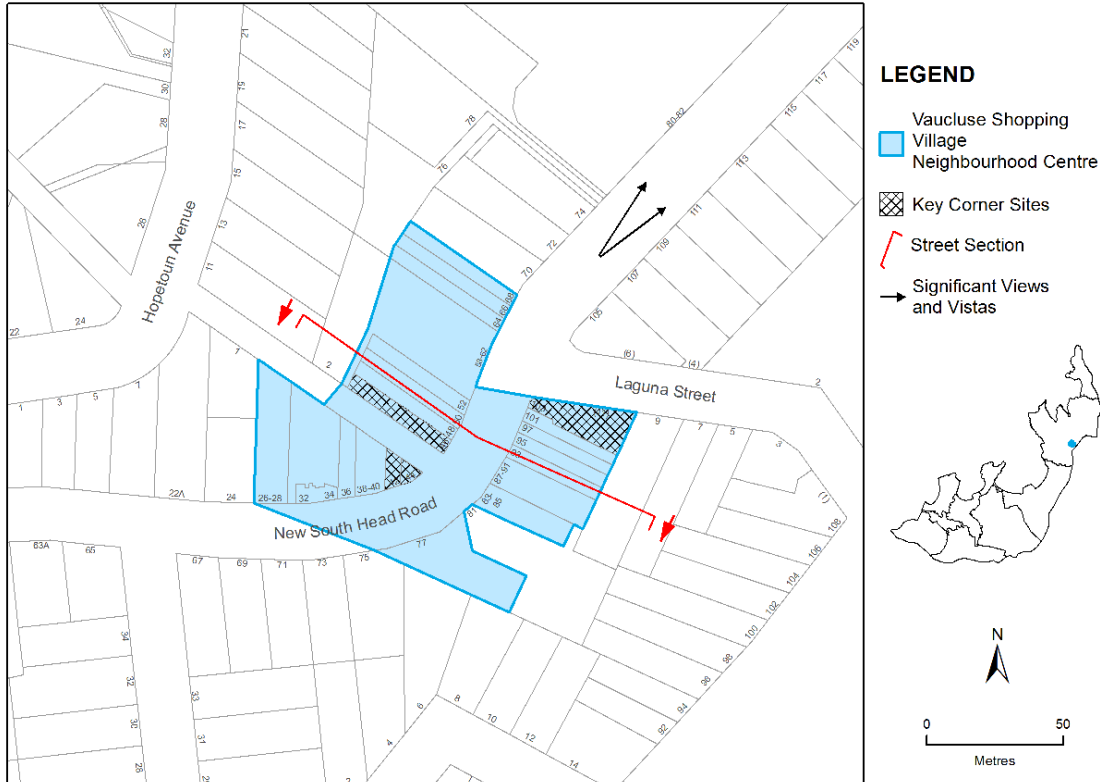
At the street level, large glass shop frontages provide great opportunity for interesting and attractive shopfront displays that contribute to the amenity of the pedestrian environment; the surface area of these windows should generally remain transparent to provide for permeability into shopfronts and promote active street frontages.

### D1.3.3 Objectives and controls

Objectives		Local controls	
O1	To provide uses that are consistent with the desired future character of the centre.	C1	Development supports adaptive re-use of existing retail units.
		C2	The ground level contains active uses, preferably a range of local and speciality shops and business premises that meet the needs of the local community.
		C3	The upper levels generally contain office uses, and/or residential uses.
O2	To protect the fabric and character of the existing Inter-war building.	C4	Development is sympathetic to the existing character and fabric of the Inter-war building.
		C5	Development retains a coherent streetscape with a consistent street wall and parapet line.
		C6	Development is a maximum of three storeys.
		C7	Development reinstates a fixed stepped awning, on its original alignment, to the building façade. The colour and materials of the awning respect the architecture and character of the building.
O3	To improve the pedestrian environment and connections to commercial activity on the eastern side of the roundabout.	C8	Development improves the existing landscape treatment and includes streetscape improvements.

## D1.4 Vaucluse Shopping Village, Vaucluse

**MAP 3** Vaucluse Shopping Village centre map



### D1.4.1 Centre character statement

Vaucluse Shopping Village is located on the ridgeline on a curved section of New South Head Road. It provides a good mix of local convenience retailing and services, including a post office, newsagent, fruit and vegetable grocer, butcher, cafes, bottle shop and florist.

The centre is characterised by two storey shop top housing, with some recent three storey infill development on the western side.

#### Historical development of the area

New South Head Road was constructed as a link to Watsons Bay during the 1830s. In 1880 the Shaftesbury Institute was opened on land currently occupied by Samuel Park and the site known as the former Vaucluse High School. The Shaftesbury Institute operated as a girls’ reformatory and then was used as an institution for non-criminal men in 1915.

Land in and near the centre was subdivided in the early 1900s and at the same time the tram line along New South Head Road was introduced. However, substantial housing development did not occur until the 1920s and 1930s.

---

In 1930 three acres of land from the Shaftsbury Institute grounds was dedicated to Council for public recreation purposes and named "Samuel Park".

Although Vaucluse Council resisted residential flat building in the municipality, some Inter-war flat buildings were built on New South Head Road near the centre. In 1960, the Vaucluse High School opened. In that same year the tram service ceased.

### **Built form**

The building stock in and around the centre includes 20th century architecture of varying quality.

The built form generally consists of:

- ▶ shop top housing in the form of predominantly two storey Inter-war buildings interspersed with more contemporary buildings;
- ▶ two and three storey mixed use developments at the north-eastern and south-western end of the centre; and
- ▶ a two storey mixed use building on the corner of New South Head Road and Laguna Street.

The buildings generally address the street, provide continuous awnings, and have parapet or hipped rooflines.

### **Public parks and community facilities**

Samuel Park, which also includes the Vaucluse Bowling Club, is located close to the centre.

### **Public domain**

The centre provides a relatively good standard of pedestrian amenity, and fairly consistent footpath treatment, street furniture and planting.

### **Access and circulation**

The centre is on the Watsons Bay bus route. However, most shoppers access the centre by car and are reliant on car transport and turnover of on-street car parking spaces. Pedestrian safety is somewhat compromised by the restricted sightlines on New South Head Road.

### **Views and aspect**

The north-eastern end of the shopping centre has views towards the Vaucluse Bowling Club and Samuel Park.

## New South Head Road and Laguna Avenue



### D1.4.2 Desired future character

---

The Vaucluse neighbourhood centre is a lively village that provides for the daily convenience needs of the local community. It is expected that this role will continue and strengthen. Higher order retailing, such as banking and weekly shopping, will be provided at larger centres such as the Rose Bay local centre.

The redevelopment of the former Vaucluse High School site for seniors living will increase the residential population within walking distance of the centre and increase the demand for daily goods and personal services. Possible redevelopment on the carwash site for mixed use development will also provide for a small extension of the centre along the eastern side. New and infill development will reinforce the village feel of the centre, providing well designed buildings that reflect the scale and rhythm of the existing built form and shopfronts.

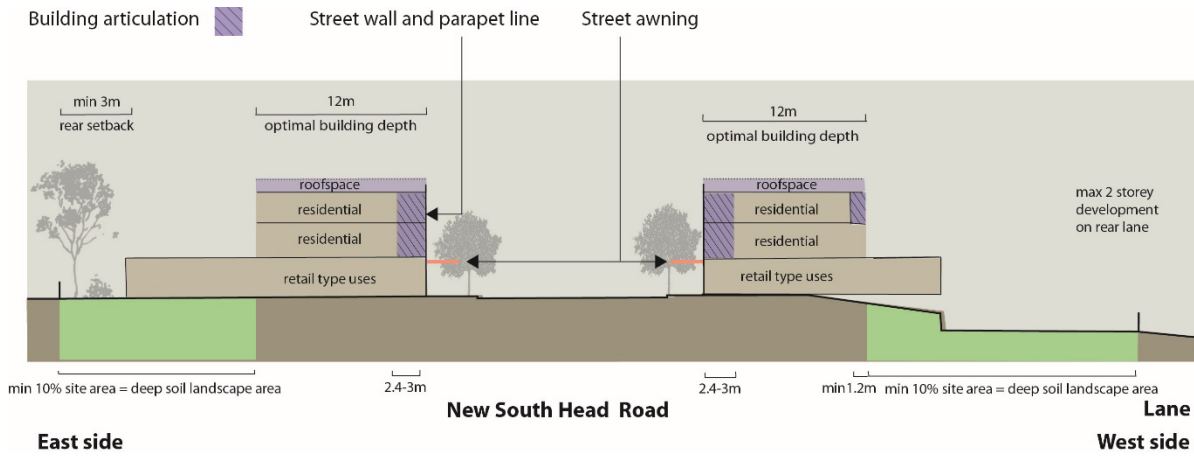
### D1.4.3 Objectives and controls

---

The street diagram illustrates some of the controls, and is to be read in conjunction with the table of objectives and controls below. Note, the maximum building height and FSR are in Woollahra LEP 2014.



**FIGURE 2** Vaucluse Village street section



Note: Street section does not apply to 26-36 New South Head Road

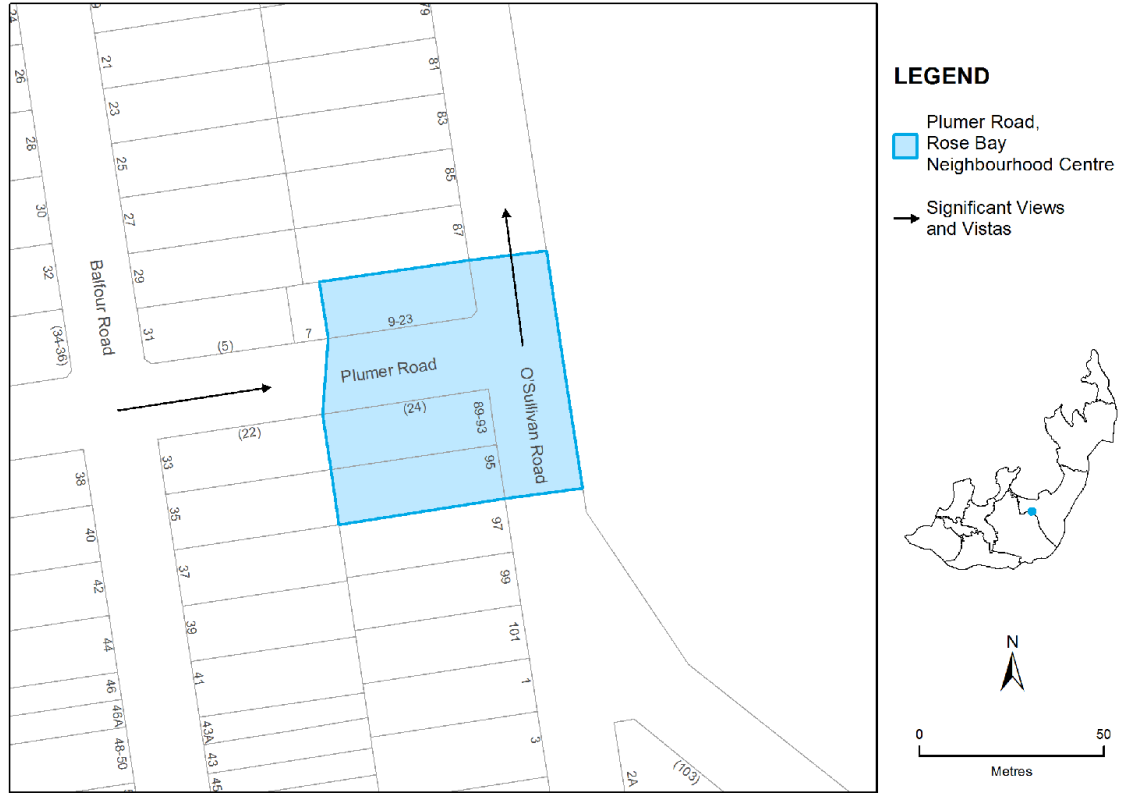
Objectives	Local controls
<p>O1 To provide uses that are consistent with the desired future character of the centre.</p>	<p>C1 Development supports adaptive re-use of existing retail units.</p> <p>C2 The ground level contains active uses, preferably local and speciality shops, business premises and cafes and restaurants that meet the needs of the local community.</p> <p>C3 Residential uses located above street level in the form of shop top housing.</p>
<p>O2 To develop a coherent streetscape with a consistent street wall.</p> <p>O3 To ensure consistency of built form and presentation to the street.</p>	<p>C4 Development is a maximum of three storeys at the New South Head Road frontage.</p> <p>C5 For properties 26-36 New South Head Road, development provides:</p> <ul style="list-style-type: none"> <li>a) two storey street wall built to the street alignment, with a continuous and consistent parapet line; and</li> <li>b) an upper level setback of at least 1.2m for at least 80% of the frontage, where setback walls are aligned parallel to the street boundary.</li> </ul> <p>C6 For all sites other than 26-36 New South Head Road, development provides a three</p>

Objectives	Local controls
	<p>storey street wall built to the street alignment, with a continuous and consistent parapet line above.</p> <p>C7 For development on the west side of the street, as identified in the street section diagram:</p> <ul style="list-style-type: none"> <li>a) building form responds to the fall of the land; and</li> <li>b) development is a maximum of two storeys to the rear lane.</li> </ul> <p>C8 Development includes a continuous solid suspended awning over the public footpath of New South Head Road and along the secondary frontage of corner sites.</p> <p>C9 Development does not include vehicular access off New South Head Road.</p>
<p>O4 To define and reinforce the corner sites in the centre.</p>	<p>C10 Development on corner sites provides three storeys built to the street alignment with a continuous and consistent parapet line above.</p>
<p>O5 To encourage good building design and limit building bulk.</p>	<p>C11 Building articulation at the street alignment is in the form of recessed balconies or loggia only. Elsewhere it may be in the form of verandahs, balconies, loggia or wall offsets.</p> <p>C12 At the street alignment, the depth of these balconies and loggia is between 2.4m to 3m.</p>

Objectives	Local controls
<p><b>O6</b> To provide for the amenity of occupants and adjoining properties.</p>	<p><b>C13</b> The building depth for storeys above the ground floor level is generally not more than 12m.</p> <p><b>C14</b> For development on the eastern side of New South Head Road, the building is setback from the rear boundary by at least 3m.</p> <p><b>C15</b> For development on the western side of New South Head Road, the building may be built to the rear lane.</p> <p><b>C16</b> At least 10% of the site is provided as deep soil landscaped area.</p>
<p><b>O7</b> To increase tree planting in the public domain.</p>	<p><b>C17</b> Development which includes public domain use, includes advanced tree planting in the footpath.</p>

## D1.5 Plumer Road, Rose Bay

**MAP 4** Plumer Road centre map



### D1.5.1 Centre character statement

The Plumer Road neighbourhood centre is a group of purpose built shops with residential uses above, located at the intersection of Plumer and O’Sullivan Roads opposite Woollahra Golf Club. This is a vibrant neighbourhood centre for the local community, providing a good range of convenience shops, including a local store, bakery, butcher and cafes.

The area has a flat topography and is characterised by mature fig trees along O’Sullivan Road. The centre is located within the Balfour Road Heritage Conservation Area, characterised by Inter-war flat buildings built between Powell Road, Salisbury Road, Plumer Road and O’Sullivan Road.

#### Historical development of the area

Speculation to create an exclusive marine estate along the esplanade at Rose Bay was commenced in the 1830s, but apart from the 1835 construction of Rose Bay Lodge (in what is now Salisbury Road) the district remained substantially undeveloped throughout the 19th century. More intensive subdivision of the land surrounding Rose Bay Lodge commenced after the introduction of the Rose Bay tram service in 1903, but development in the area was slow.

---

The Plumer Road shops were part of the Beresford Estate and were subdivided from 1925 to 1928 as business sites. Development of residential blocks occurred in the area from the early to mid-1920s. The Balfour Road Heritage Conservation Area represents the intensified residential development of Rose Bay during the Inter-war period.

### **Built form**

Like most buildings in the Balfour Road Heritage Conservation Area, the Plumer Road shops are two and three storey builder's blocks of flats (i.e. speculative, not architect designed) built in the 1920s and mid 1930s displaying distinctive architectural characteristics of the Inter-war Art Deco style.

The buildings form a highly distinctive collection of traditionally detailed retail building forms, dating back to the Inter-war period. Some of the important built form characteristics include continuous awnings and a hipped roof form, buildings built to the street alignment with large display windows on the ground floor, and windows and balconies overlooking the street.

### **Heritage and contributory buildings**

The centre is located within the Balfour Road Conservation Area. The shop top housing at Nos 89-93 O'Sullivan Road and 9-23 Plumer Road make an important contribution to the Balfour Road HCA as they form a gateway to the centre.

### **Public parks and community facilities**

Woollahra Golf Club is located immediately opposite the shops on O'Sullivan Road.

### **Public domain**

The centre has high visual amenity. The continuous awnings, common fascia signage and well maintained concrete footpaths and buildings provide good amenity for pedestrians. The fig tree planting on O'Sullivan Road provides a leafy backdrop to the centre. The setback area on O'Sullivan Road facilitates outdoor dining.

### **Access and circulation**

The centre is located close to the Bondi Junction to City bus route and routes on New South Head Road. However, most shoppers access the centre by foot or are reliant on car and a turnover of the on-street car parking spaces.

### **Views and aspect**

The centre enjoys views to Woollahra Golf Club, and from O'Sullivan Road there is a tree canopied vista to the harbour.

## Plumer Road and O'Sullivan Road



### D1.5.2 Desired future character

---

The Plumer Road neighbourhood centre will remain a small but lively village providing for the daily convenience shopping needs of the local community, and serving as a social hub for the community to meet and interact. Higher order retailing, such as banking and weekly shopping, will be provided at larger centres including the Rose Bay and Double Bay local centres.

The centre has a high aesthetic value, predominantly derived from the Inter-war shop top buildings. These contributory buildings should not be altered, and the consistent colour schemes applied to these buildings, awnings and signage are to be retained, as these provide a unifying theme throughout the centre and contribute to its visual amenity and character.

The existing development at 95 O'Sullivan Road detracts from the centre and any future redevelopment on this site should more suitably respond the character of the centre and the significance of the adjoining HCA.

### D1.5.3 Objectives and controls

Objectives	Local controls
<p>O1 To provide uses that are consistent with the desired future character of the centre.</p>	<p>C1 Development supports the adaptive re-use of existing shop top units.</p> <p>C2 The ground level contains active uses, preferably local shops, cafes and restaurants that meet the needs of the local community.</p> <p>C3 Residential uses are located above street level in the form of shop top housing.</p> <p>C4 Development provides high amenity outdoor dining in the O'Sullivan Road setback area.</p>
<p>O2 To maintain the existing built form so that the centre remains the “gateway” to the Balfour Road Centre Heritage Conservation Area.</p>	<p>C5 Development at 89-93 O'Sullivan Road and 9-23 Plumer Road maintains existing building height, scale and form.</p> <p>C6 Parking is located at the rear of the building. No parking spaces or garages permitted in the front setback area.</p> <p>C7 Development maintains the existing building separation pattern to neighbouring residential lots by retaining the existing driveway crossovers on the edge of the centre.</p>
<p>O3 To retain and enhance the contributory buildings and ensure these retain their streetscape context.</p>	<p>C8 Development at 89-93 O'Sullivan Road and 9-23 Plumer Road maintains and retains the heritage significant fabric.</p> <p>C9 Development provides a continuous awning to the street frontage to match existing awnings at 89-93 O'Sullivan Road and 9-23 Plumer Road.</p> <p>C10 Development does not include habitable space in the roof structure of an existing building, and does not include any dormer window.</p> <p>C11 Any replacement of heritage significant building fabric is of similar material and</p>

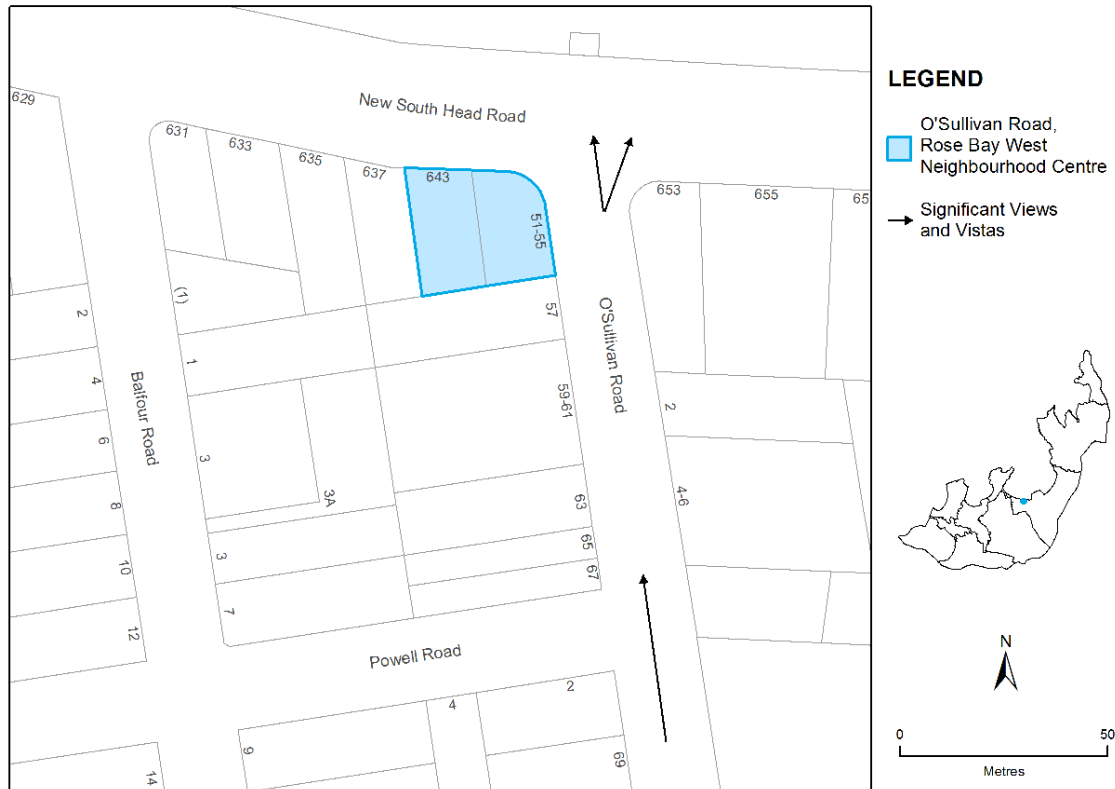
Objectives	Local controls
	<p>type (e.g. timber for timber).</p> <p>C12 Development reinstates heritage significant architectural detailing as appropriate.</p> <p>C13 Development retains and conserves any original chimneys.</p> <p>C14 Development does not include any painting, bagging or rendering of original face brickwork.</p> <p>C15 Development retains window and door hardware that have heritage significance.</p> <p>C16 Development does not include any infill (by glazing or otherwise) of original verandahs or balconies.</p> <p>C17 Security grilles on windows and doors, if installed, complement the frame and glazing pattern, are fitted on the inside of windows or doors, and should not be visually intrusive.</p> <p>C18 Security fly screens, if installed, are retractable.</p> <p>C19 Skylights and the like, are not visible from any street frontage.</p> <p>Note: Solar energy systems such as photovoltaic electricity generating systems, solar hot water systems, or solar air heating systems are addressed in Chapter E6, Section 6.3 Solar Energy Systems.</p>



Objectives		Local controls	
O4	To support redevelopment of buildings that detract from the streetscape character.	C20	Development at 95 O’Sullivan Road is a maximum of three storeys.
		C21	Development at 95 O’Sullivan Road presents a similar roof form and pitch as adjoining buildings, when viewed from the public domain.
		C22	Development is setback from O’Sullivan Road to match existing commercial buildings and does not include structures within the setback area.
O5	To maintain the leafy character and ambience of O’Sullivan Road.	C23	Development which includes public domain use provides advanced tree planting in the O’Sullivan Road setback area that reinforces and complements the existing avenue of mature trees.
O6	To minimise the impact of signs on the amenity and character of the buildings and the significance of the heritage conservation area.	C24	New signage is of a compatible design and colour to existing signage in the centre. A coordinated approach to the signs within the centre is preferred.
		C25	Colours used in signs are consistent with the architectural style of the building. Fluorescent and iridescent colours are not permitted.
		C26	Fonts used in signs are consistent with the style of the building and the historic character of the area.

## D1.6 O’Sullivan Road, Rose Bay

**MAP 5** O’Sullivan Road centre map



### D1.6.1 Centre character statement

This small group of shops, located within two buildings, is sited at the junction of New South Head Road and O’Sullivan Road. The corner site contains a single storey heritage listed building, which was originally established as a service station and is now used as a drive through dry cleaning business. The other uses in the centre are restaurants and cafes.

The location enjoys views overlooking the Rose Bay waterfront and promenade. However, the quality of the public realm is compromised by the proximity of the busy New South Head Road and a streetscape which would benefit from street trees and a consistent footpath treatment to soften the environment.

#### Historical development of the area

The Rose Bay area was originally part of the Cooper Estate. Speculation to create an exclusive Marine Estate along the esplanade commenced in the 1830s, but apart from the construction of Rose Bay Lodge in 1835, the district remained substantially undeveloped throughout the 19th century.

---

More intensive subdivision of the land surrounding Rose Bay Lodge commenced after the introduction of the Rose Bay tram service in 1903, but development in the area was slow. Early residential flat development in the area dates from the early to mid-1920s. The nearby Balfour Road Heritage Conservation Area represents the intensified residential development of Rose Bay during the Inter-war period.

This small neighbourhood centre occupies land subdivided from the grounds of Rose Bay Lodge in 1900, called the Beresford Estate. The three lots created at O'Sullivan Road and New South Head Road were subsequently merged and re-subdivided in 1928. In that same year, land now known as 51-55 O'Sullivan Road was developed as a service station and shops in response to the increasing number of motorists in the area. The building was constructed in the Spanish Mission style, popular at the time, and is now a heritage item.

### **Built form**

The O'Sullivan Road shops occupy a single storey Spanish Mission style corner building with driveway apron (that was previously a garage and service station), and a two storey late 20th century shop top built to the New South Head Road street alignment.

Surrounding buildings are typically three storey brick builder's blocks of flats with hipped roof form, setback from the boundary on both O'Sullivan Road and New South Head Road.

### **Heritage item**

The Spanish Mission style building at 51-55 O'Sullivan Road is a heritage item. It has significance as a rare and representative surviving example of early service station architecture influenced by Californian design.

### **Public parks and community facilities**

The Rose Bay promenade is located across the road from the centre on the northern side of New South Head Road. The Woollahra Golf Club is located immediately opposite the Plumer Road shops in O'Sullivan Road.

### **Public domain**

The site has excellent north and east sun access and exposure to harbour breezes. High traffic volumes, fragmented pavement areas, lack of street trees or continuous awnings and the poorly defined corner adversely affect the public domain.

### **Access and circulation**

The centre is well served by bus routes on New South Head Road. However, most people dining at the restaurants or collecting dry cleaning walk to the centre, or access the centre by car.

There is an existing parking bay for three cars immediately in front of the centre on New South Head Road. Additional on-street parking is available on the other side of New South Head Road, as well as O'Sullivan Road.

### **Views and aspect**

The centre enjoys broad views over Rose Bay and a green outlook to tree lined O'Sullivan Road.

---

New South Head Road and O'Sullivan Road



### D1.6.2 Desired future character

This centre has recently emerged as a small café centre with outdoor dining. There is opportunity for the amenity of the centre to improve if the existing building stock is redeveloped and improvements are made to the public domain to help soften the impact of traffic along New South Head Road, whilst maintaining views across the road to the Rose Bay promenade and Sydney Harbour.

Any redevelopment of the Spanish Mission style building must respect the existing façade elements on O'Sullivan Street, which are built to the boundary. The existing setback of the building to New South Head Road should be maintained to preserve the corner forecourt. For example this area may be suitable as an outdoor dining area.

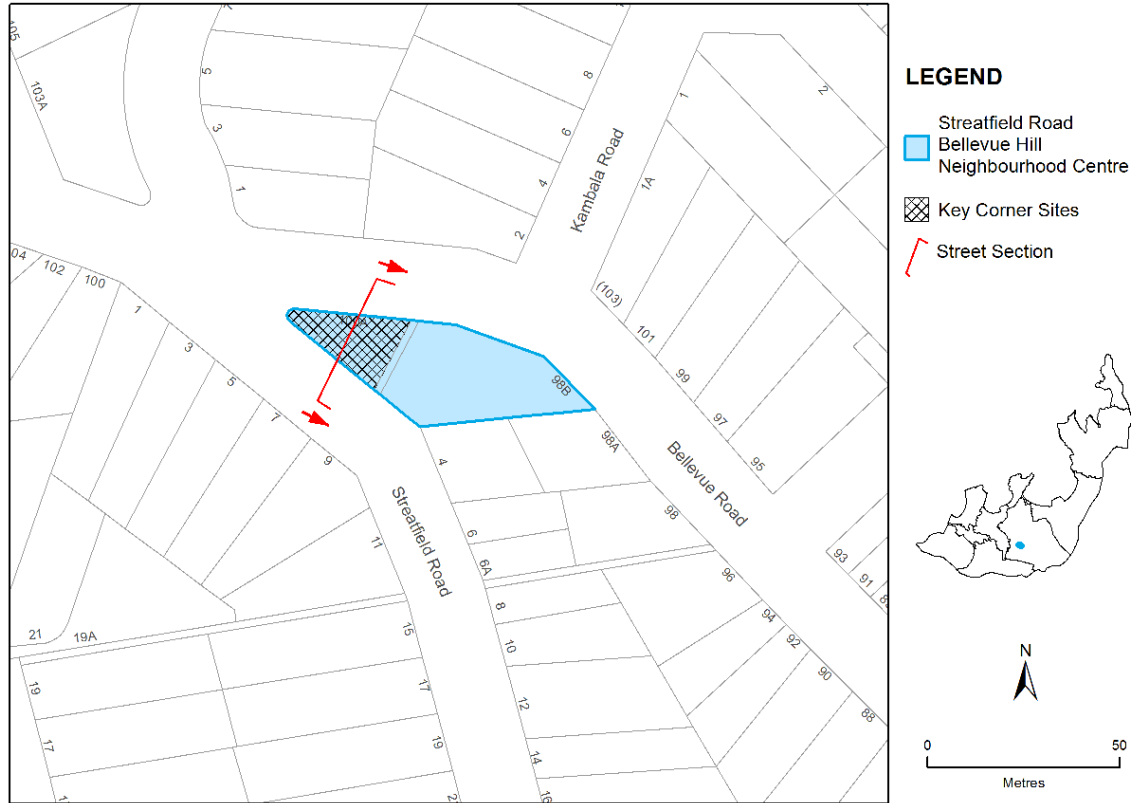
The corner site contains a heritage item, which has a prominent corner location. Development is to have regard to the original character of the building.

### D1.6.3 Objectives and controls

Objectives		Local controls	
O1	To provide uses that are consistent with the desired future character of the centre.	C1	Development provides active shop frontage and high amenity outdoor trading.
O2	To provide a high amenity pedestrian and outdoor trading area overlooking Rose Bay and the promenade.	C2	The ground level contains active uses, preferably cafes and restaurants that meet the needs of the local community.
		C3	Residential uses are located above street level in the form of shop top housing.
O3	To protect the fabric, character and significance of the existing Spanish Mission style heritage building.	C4	Key original architectural features of the building are retained.
		C5	The spatial relationship of the existing forecourt to the building is retained.
O4	To support redevelopment of buildings to enhance the streetscape character.	C6	Development is a maximum of three storeys.
		C7	Development is sympathetic to the existing character, fabric and heritage significance of the Spanish Mission style building.
O5	To protect identified views within the centre.	C8	Development retains views from the centre across New South Head Road to the Rose Bay promenade and Sydney Harbour.

## D1.7 Streatfield Road

MAP 6 Streatfield Road centre map



### D1.7.1 Centre character statement

The Streatfield Road shops are a small group of shops on the western side of Bellevue Road, approximately halfway between Double Bay and Bellevue Hill, at the junction with Streatfield Road. The centre provides a small selection of local and specialty shops, personal services and cafes.

The appearance and amenity of this neighbourhood centre is largely defined by the Inter-war shop top building at 98B Bellevue Road, but the centre also contains two other buildings at 100A Bellevue Road. These have a single storey elevation to Bellevue Hill Road and contain a bottle shop, dwelling house and café.

#### Historical development of the area

In the early 19th century the Bellevue Hill area was part of the Point Piper Estate, an extensive private land grant made to Cooper and Levey in 1820. The Bellevue Hill and Bellevue Park Estates were subdivided and re-subdivided from the estate between 1883 and 1912, producing smaller lots on the higher slopes and areas away from the harbour. Early urban development intensified in 1909 following the extension of the tramline along Old South Head Road.

---

The Streatfield Road centre is located on Point Piper Estate land subdivided in 1920. The Inter-war building at 98B Bellevue Road was purpose built shop top housing and dates from 1929.

### Built form

The neighbourhood centre is contained in three buildings: a well conserved two to three storey Inter-war residential retail complex that follows the curve and grade of Bellevue Road, a single storey flat roof building of poorer quality, and a two storey cottage on the corner.

These buildings contain active frontages to Bellevue Road, while presenting a more residential character to the Streatfield Road elevation.

### Access and circulation

The centre is well located adjacent to a bus stop for services operating on Bellevue Road. It is readily accessible by car with a limited number of on-street parking spaces. Pedestrian amenity and safety is compromised by vehicular traffic speeds and limited sight lines on Bellevue Road.

### Views and aspect

The centre has a pleasant outlook along Bellevue Road.

### New South Head Road and O'Sullivan Road



### D1.7.2 Desired future character

The Streatfield Road shops will retain its role as a small but vibrant neighbourhood centre that meets the needs of the local community by providing a mix of daily convenience shopping, cafes as well as specialty shops and personal services.

Development should ensure a visually attractive and coherent physical environment recognising the character of the existing built environment, with a built form that addresses Bellevue Road and the corner of Bellevue Road and Streatfield Road.

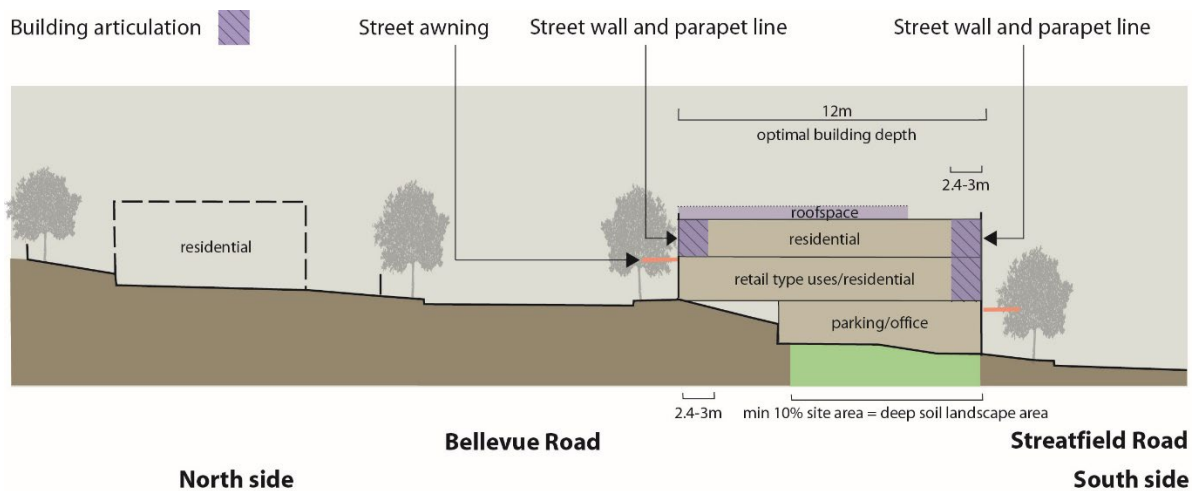
The building at 98B Bellevue Road is a face brick Inter-war residential retail complex with a two storey frontage to Bellevue Road. It is envisaged that this character will remain largely intact. This building is in good condition with much of the external fabric sympathetically maintained. The building establishes a strong street wall and parapet line that responds sensitively to the grade and curve of the site and establishes a strong street wall and parapet line that responds sensitively to the grade and curve of the site and creates a landmark presence. The original stepped awning has been replaced with lightweight structures of varying colours and styles. The appearance of this building would be enhanced if the awnings, including the style and colour, were consistent and more sympathetic to the original character of the building.

Redevelopment at 100A Bellevue Road is to complement the built form and character of the built form at 98B Bellevue Road.

### D1.7.3 Objectives and controls

The street diagram illustrates some of the controls, and is to be read in conjunction with the table of objectives and controls below. Note, the maximum building height and FSR are in Woollahra LEP 2014.

**FIGURE 3** Streatfield Road street section





Note: Street section refers to 100a Bellevue Road only

Objectives	Local controls
<p>O1 To provide uses that are consistent with the desired future character of the centre.</p>	<p>C1 Development supports the adaptive re-use of existing shop top units at 98B Bellevue Road.</p> <p>C2 The ground level contains active uses, preferably local and speciality shops, business premises and cafes and restaurants that meet the needs of the local community.</p> <p>C3 Residential uses are located above the street level in the form of shop top housing.</p> <p>C4 Office uses may be located at the Streatfield Road frontage.</p>
<p>O2 To establish a strong and continuous built form that addresses both Bellevue Road and Streatfield Road.</p>	<p>C5 Development provides two storeys built to the Bellevue Road street alignment, with a continuous and consistent parapet line above (refer to the street section diagram).</p> <p>C6 Development provides three storeys built to the corner intersection at Streatfield Road, with a continuous but stepped parapet line above.</p> <p>C7 Development provides a built form with small scale shopfronts that step with the street grade.</p> <p>C8 Development includes a continuous but stepped awning over the public footpath of Bellevue Road and around the corner radius into Streatfield Road.</p> <p>C9 Development at 100A Bellevue Road complements the built form and character of 98B Bellevue Road.</p>

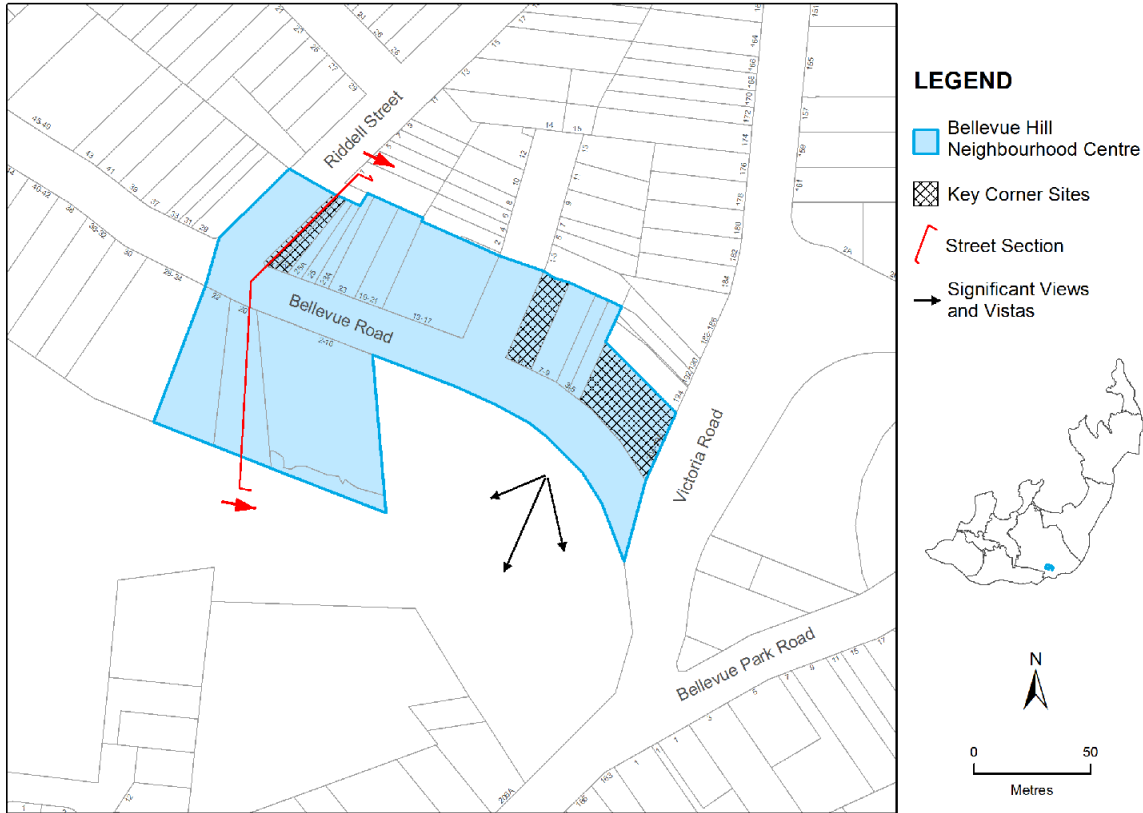
Objectives		Local controls	
O3	To protect the fabric and character of the Inter-war building at 98A Bellevue Road.	C10	Key original architectural features of the building are retained, or if required synthetically restored or replaced.
		C11	Development re-instates the fixed stepped awning at 98B Bellevue Road.
		C12	Colours used in signs are consistent with the architectural style of the building. Fluorescent and iridescent colours are not permitted.
		C13	Fonts used in signs are consistent with the style and character of the building.
O4	To encourage good building design and limit building bulk.	C14	At both street frontages at least 80% of the articulation zone is occupied by floor area elements or recessed balconies.
		C15	The depth of the floor area elements and recessed balconies is between 2.4 to 3m.
O5	To provide for the amenity of occupants.	C16	The building depth is generally not more than 12m.
O6	To provide good pedestrian access, amenity and connectivity between Bellevue Road and Streatfield Road.	C17	Development of 100A Bellevue Road includes no more than one single width vehicle access crossing that is located on Streatfield Road.
		C18	Development of 100A Bellevue Road maintains a direct public accessway from Streatfield Road to Bellevue Road between properties at 98B and 100A Bellevue Road.
		C19	Development of 100A Bellevue Road provides at least 10% of the site as deep soil landscaped area on the boundary to 98B Bellevue Road adjacent to the accessway.

---

Objectives	Local controls
07 To improve the public domain for outdoor uses.	C20 Development enhances the amenity of the footpath area.  C21 Development includes tree planting along both the Bellevue Road and Streatfield Road frontages, where this can be accommodated with the provision of awnings.

## D1.8 Bellevue Hill Shops

MAP 7 Bellevue Hill Shops centre map



### D1.8.1 Centre character statement

The Bellevue Hill Shops neighbourhood centre is a relatively large group of shops located on the ridgeline at the junction of Bellevue Road and Victoria Road (both of which are important urban collector roads linking New South Head and Old South Head Roads). To the south, the centre overlooks the upper extent of Cooper Park.

The centre provides a good mix of local convenience shopping and personal services, such as a post office, newsagent, fruit and vegetable grocer, butcher, chemist, hairdressers, real estate agents, cafes, bottle shop, and dry cleaner.

#### Historical development of the area

Hill top ‘BelleVue’ (now Bellevue Park) was known in the early 19th century for its panoramic views to the harbour and the ocean. The area was then part of the Point Piper Estate, an extensive private land grant to Cooper and Levey. The Bellevue Hill and Bellevue Park Estates were subdivided and re-subdivided from the estate between 1883 and 1912, producing smaller lots on the higher slopes away from the harbour. Following the extension of the tramline along Birriga Road in 1909 urban development intensified.

---

Residential flats were built on larger sites overlooking Cooper Park from the end of World War I. However, retail and business uses were not permitted on the northern side of Bellevue Road between Victoria Road and Riddell Street until 1929. Around this time the Bellevue Hill Primary School (1925) and St Stephens Church (1928) were also established close to the centre on Victoria Road.

The centre has seen a continuous process of development, creating a vibrant mix of retail, business and residential uses.

### Built form

The building stock in and around the centre is represented by a cross section of 20th century architecture of varying quality. This includes:

- ▶ Inter-war shops with one storey above for residential or commercial uses, typically built to the boundary with a street parapet line and a deep solid suspended awning over the footway.
- ▶ One free standing mixed use Inter-war building comprising shops at street level with two storeys of residential above at 22 Bellevue Road.
- ▶ A 1960s-70s large mixed use building on the western corner of Buller Street and Bellevue Road with shops at street level and a nine storey tower setback from Bellevue Road. This building has a porte cochere to Buller Street.
- ▶ Contemporary mixed use buildings comprising shops at street level with two to three storeys of residential above at street level, such as development at 11 Bellevue Road and the development on the corner of Bellevue Road and Victoria Road. More recent development at 2-16 Bellevue Road is three storeys built to the street alignment with approximately six levels stepping down the hillside.

### Parks and community facilities

Bellevue Hill Public School is immediately east of the centres with Bellevue Hill Park beyond. The eastern part of the retail centre overlooks the extensive gully of Cooper Park which runs down to Double Bay.

### Public domain

The pedestrian amenity varies depending on the location of awnings and shade trees; for example, there is limited solar access to the footpath on the northern side.

At street level there is a variety of building setbacks, alcoves, colonnades and recessed entrances and driveways that could attract antisocial behaviour. Opportunities exist for the improvement of public domain.

### Access and circulation

The centre is well served by buses although most shoppers drive to the centre and are reliant on turnover of limited on-street car parking spaces. Angle parking has been introduced in Riddell Street to increase yield.

A few properties on the northern side of Bellevue Road have rear lane access from Riddell Lane and can provide on-site parking.

**Views and aspect**

Good views of Cooper Park are available from upper levels at the eastern end of the centre, and from the southern side of Bellevue Road.

**Bellevue Road and Riddell Street**



**D1.8.2 Desired future character**

---

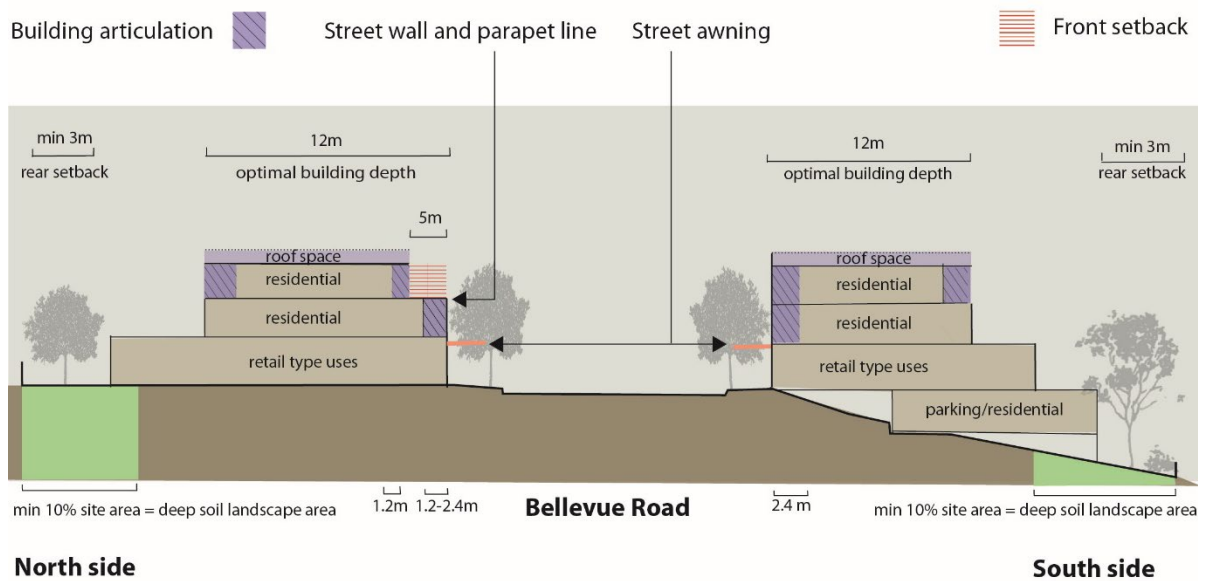
The Bellevue Hill Shops neighbourhood centre should continue to provide a good mix of daily convenience shopping, food premises and personal services. The development of outdoor dining will also help create a more vibrant centre.

Mixed use developments with active street frontages and residential uses above are encouraged and will promote the ongoing vitality of this centre. Street plantings and street furniture will contribute to a more visually attractive environment.

### D1.8.3 Objectives and controls

The street diagram illustrates some of the controls, and is to be read in conjunction with the table of objectives and controls below. Note, the maximum building height and FSR are in Woollahra LEP 2014.

**FIGURE 4** Bellevue Hill Shops street section



Objectives	Local controls
O1 To provide uses that are consistent with the desired future character of the centre.	C1 The ground level contains active uses, preferably local and speciality shops, business premises and cafes and restaurants that meet the needs of the local community.
	C2 Residential uses are located above the street level in the form of shop top housing.

Objectives	Local controls
<p>O2 To develop a coherent streetscape with a consistent street wall and consistent upper level setbacks.</p>	<p>C3 Development on the south side of Bellevue Road:</p> <ul style="list-style-type: none"> <li>a) is a maximum of three storeys at the street frontage;</li> <li>b) is built to the street alignment, with a continuous and consistent parapet line above; and</li> <li>c) building form responds to the fall of the land, but does not exceed maximum LEP height for this site at any point at the rear.</li> </ul> <p>C4 Development on the north side of Bellevue Road:</p> <ul style="list-style-type: none"> <li>a) is a maximum of 3 storeys;</li> <li>b) is two storeys built to the street alignment, with a continuous and consistent parapet line above; and</li> <li>c) development above the second storey is set back from the street alignment by at least 5m.</li> </ul> <p>C5 Development includes a continuous solid suspended awning over the footpath at Bellevue Road and along the secondary frontage of corner sites.</p> <p>C6 Development on the north side of Bellevue Road does not include vehicular access from Bellevue Road.</p>
<p>O3 To encourage good building design and limit building bulk.</p>	<p>C7 At least 80% of the articulation zone is occupied by floor area elements or balconies.</p> <p>C8 Building articulation at the street alignment is in the form of recessed balconies or loggia only. Elsewhere it may be in the form of verandahs, balconies, loggia or wall offsets.</p> <p>C9 At the street alignment on the southern side, the depth of the balconies and loggia is at least 2.4m.</p>

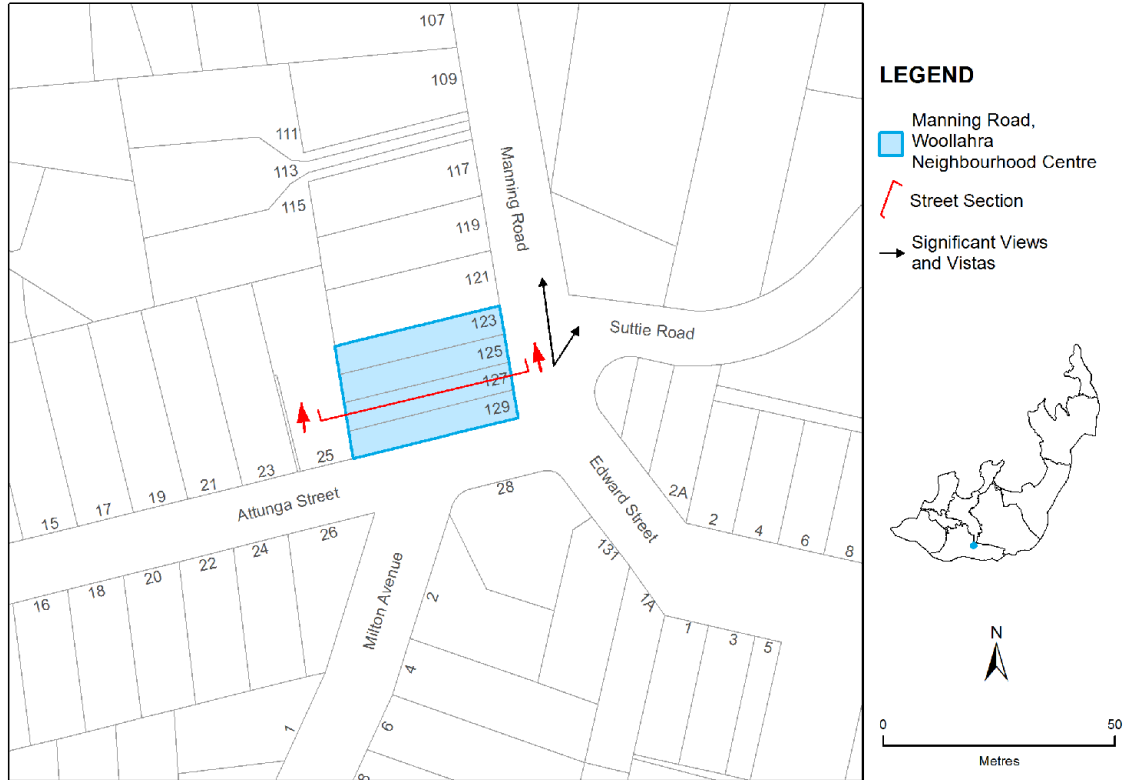


Objectives		Local controls	
		C10	At the street alignment on the northern side, the depth of the balconies and loggia is: <ul style="list-style-type: none"> <li>a) between 2.4 to 3m for the first floor; and</li> <li>b) at least 1.2m for the upper floor.</li> </ul>
O4	To improve the architectural quality of building stock.	C11	Alterations and additions to 13-17 Bellevue Road provide a three storey retail or commercial corner element built to both street alignments.
O5	To strengthen poorly defined corners.	C12	Development upgrades and reinforces the landmark corner of Victoria and Bellevue Roads by: <ul style="list-style-type: none"> <li>a) building to the street alignment up to three storeys;</li> <li>b) improving the awning;</li> <li>c) increasing frontage glazing; and</li> <li>d) introducing a parapet line.</li> </ul>
		C13	Development on corner site provides three storeys built to the street alignment with a continuous and consistent parapet line above.
O6	To provide for the amenity of occupants.	C14	The building depth for storeys above the ground floor level is generally not more than 12m.
		C15	The building is setback from the rear boundary by at least 3m.
		C16	At least 10% of the site is provided as deep soil landscaped area.
O7	To encourage outdoor dining to improve the vitality of the centre.	C17	Development provides a small north facing outdoor dining space with good sun access.

Objectives	Local controls
<p>O8 To enhance the visual connections between the centre and Cooper Park.</p>	<p>C18 At the eastern end of Bellevue Road, on the northern side, development introduces outdoor dining that has an outlook to Cooper Park.</p> <p>C19 Development on the south side of Bellevue Road provides retailing units designed with an elevated outlook over Cooper Park.</p>

## D1.9 Manning Road, Woollahra

**MAP 8** Manning Road centre map



### D1.9.1 Centre character statement

The Manning Road neighbourhood centre is located at the lower end of the Cooper Park Gully at the junction of Manning Road and Edward Street. It is a very small centre situated about midway between Double Bay and the Edgecliff Road centre.

The centre comprises four ground floor premises, currently occupied by a café and specialist services.

#### Historical development of the area

Edgecliff Road was formed in 1844 as the eastern boundary of the Cooper Estate that skirted around the top of the slopes of the Double Bay valley. The Harbour View Estate was released in 1900 and extends from Edgecliff Road down to the lower end of Cooper Park (dedicated in 1919). Following the introduction of the tram on Edgecliff Road in 1909, Inter-war subdivision of land occurred along Manning Road.

#### Built form

The small group of business and retailing premises occupy two double storey residential buildings that have been modified by the addition of awnings and hard pavement to the front setback area.

South-east of the centre along Edward Street, the built form is mainly attached housing (terraces) and cottages on small allotments with little or no front setback. Development to the north and west of the centre generally comprises large two storey detached houses and a few small residential flat blocks of three to four storeys, set in established treed gardens.

### Public parks and community facilities

The Manning Road neighbourhood centre overlooks the Lough Playing Field and treed slopes in the filled gully of Cooper Park.

### Public domain

The centre has reasonable pedestrian amenity with deep awnings, small street trees and a wide paved setback area for outdoor dining. The resolution of pavement levels and accessibility from the street is generally poor. Pedestrian movement to and from Cooper Park is compromised by speed of vehicular traffic and limited sightlines.

### Access and circulation

The centre is served by buses running along Manning Road, although most people who use the centre either walk to the centre or drive, relying on the turnover of on-street car parking spaces.

### Views and aspect

The centre faces east to the Lough Playing Field and Cooper Park.

### Manning Road and Attunga Street



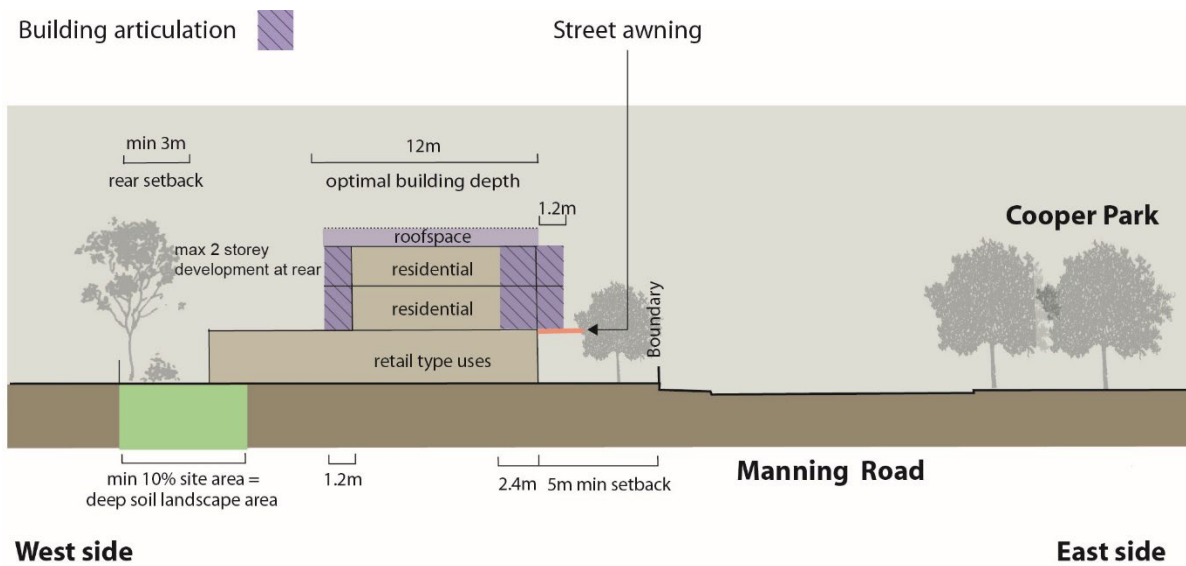
## D1.9.2 Desired future character

The Manning Road shops are a small centre that will continue to serve the needs of the local community, particularly with uses such as cafes and neighbourhood shops. Redevelopment of the existing buildings should retain the large setback from Manning Road to provide continued opportunity for outdoor dining, as well as enhance the public realm through improved landscaping and pavement treatments.

### D1.9.3 Objectives and controls

The street diagram illustrates some of the controls, and is to be read in conjunction with the table of objectives and controls below. Note, the maximum building height and FSR are in Woollahra LEP 2014.

**FIGURE 5** Manning Road street section



Objectives	Local controls
<p><b>O1</b> To provide uses that are consistent with the desired future character of the centre.</p>	<p><b>C1</b> The ground level contains active uses, preferably local shops and cafes and restaurants that meet the needs of the local community.</p> <p><b>C2</b> Residential uses are located above the street level in the form of shop top housing.</p> <p><b>C3</b> The existing traditional small shop front widths are maintained.</p>
<p><b>O2</b> To retain a coherent streetscape with a consistent street wall.</p>	<p><b>C4</b> Development is a maximum of three storeys at the Manning Road frontage.</p>
<p><b>O3</b> To minimise impact on adjoining residential land.</p>	<p><b>C5</b> Development is a maximum of two storeys at the rear of the site.</p>

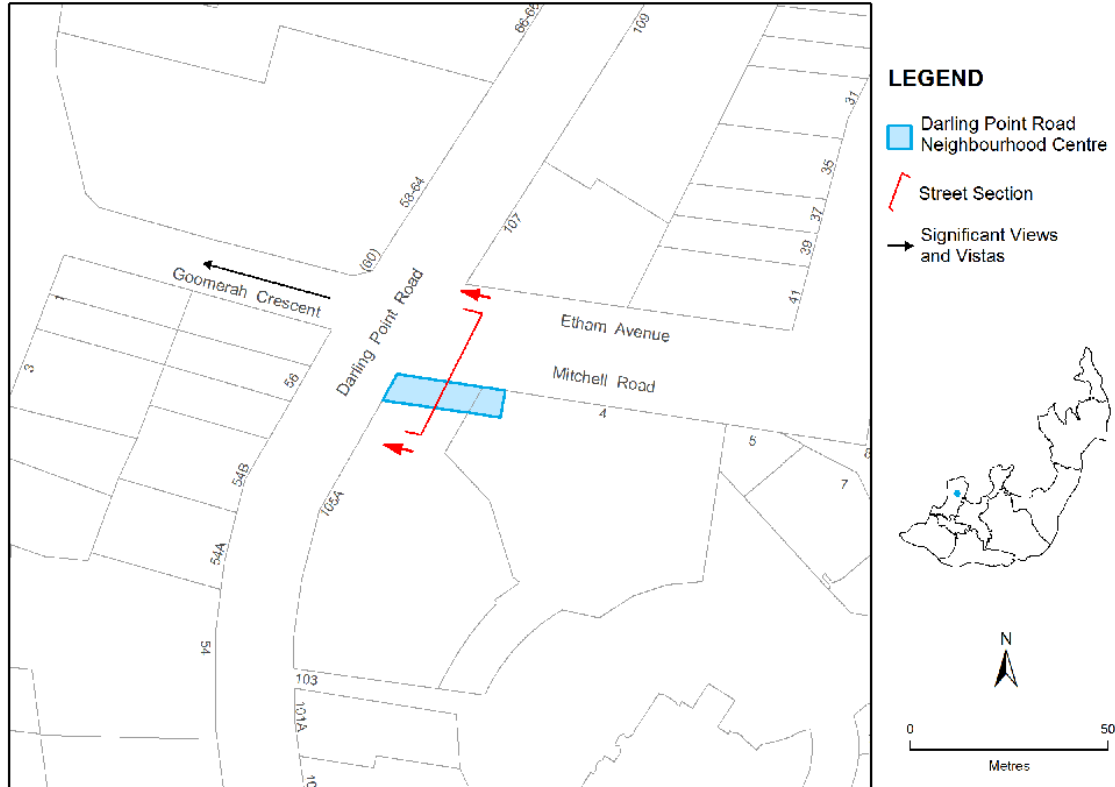
Objectives		Local controls	
O4	To encourage good building design and limit building bulk.	C6	Building articulation is in the form of: <ul style="list-style-type: none"> <li>a) projecting balconies over the front awning; and</li> <li>b) recessed balconies and loggia within the building mass.</li> </ul>
		C7	At the street alignment: <ul style="list-style-type: none"> <li>a) the projecting balconies extend from the building line onto the awning by no more than 1.2m; and</li> <li>b) the depth of the recessed balconies and loggia is at least 2.4m.</li> </ul>
		C8	At the rear alignment, the depth of the balconies and loggia on the upper levels is at least 1.2m.
O5	To provide for the amenity of occupants and adjoining properties.	C9	The building depth for storeys above the ground floor level is generally not more than 12m.
		C10	The building is setback from the rear boundary by at least 3m.
		C11	At least 10% of the site is provided as deep soil landscaped area.
O6	To retain the setback areas to Manning Road for outdoor dining and public use.	C12	Development is setback at least 5m from the Manning Road boundary.
O7	To improve the pedestrian connection between the centre and Cooper Park.	C13	Development does not include vehicular access from Manning Road.
O8	To improve the amenity of pedestrian and outdoor trading areas.	C14	Development includes a continuous solid suspended awning over the Manning Road setback area (refer to street section diagram).
		C15	Development includes advanced tree planting and landscape works to improve amenity of the setback area, where this can be accommodated with the provision of awnings.

---

Objectives	Local controls
O9 To protect views from the centre to Cooper Park.	C16 Development, including any public domain improvements, maintains the views to Cooper Park.

## D1.10 Darling Point Road, Darling Point

MAP 9 Darling Point Road centre map



### D1.10.1 Centre character statement

This is a very small centre comprising just the Darling Point Village Store. This is a local shop offering daily convenience goods and services and a cafe.

This centre is located on the corner of Darling Point Road, facing Mitchell Street on the perimeter of the former Babworth House Estate. The gardens and tree canopy immediately behind the centre provide an understanding of the site’s relationship to the adjoining Babworth House Estate, which is listed as a heritage item.

#### Historical development of the area

Significant subdivision of Darling Point occurred in the early 1830s with a number of large estates established at that time. Its position and aspect to Sydney Harbour ensured that the wealthy reserved this small promontory for their grand residences.

However, by the late 1800s, smaller residences were also numerous, and during the 20th century development intensified as more allotments were subdivided from the grounds of the great houses and gentleman’s villas. The Etham Estate (1900) was one such subdivision located close to this centre.



---

During the second half of the 20th century, a number of high rise units were built throughout Darling Point. The Darling Point neighbourhood centre was constructed during this period.

### Built form

This shop is located in a single storey flat roofed building. It is built to the street alignment with a small canvas awning. High rise apartment blocks are located within the grounds of the former Babworth House Estate.

There are a diverse mix of dwelling types in walking distance to the centre, including grand 19th century two storey dwelling houses, attached dwellings (terraces) and residential flat buildings.

### Public domain

The centre has reasonable pedestrian amenity with a northerly aspect and a wide paved area for outdoor uses. Mature street trees in Darling Point Road and nearby gardens provide the centre with a leafy ambience. Amenity would be further improved if street trees were planted in the footpath outside the centre.

### Access and circulation

The centre is served by buses running along Darling Point Road, although people tend to walk or drive to the centre.

### Views and aspect

There is a view of the harbour looking west down Goomerah Crescent.

### Mitchell Street at Darling Point Road



### D1.10.2 Desired future character

---

The Darling Point Road centre will be a small neighbourhood centre, providing for the daily needs of the local community.

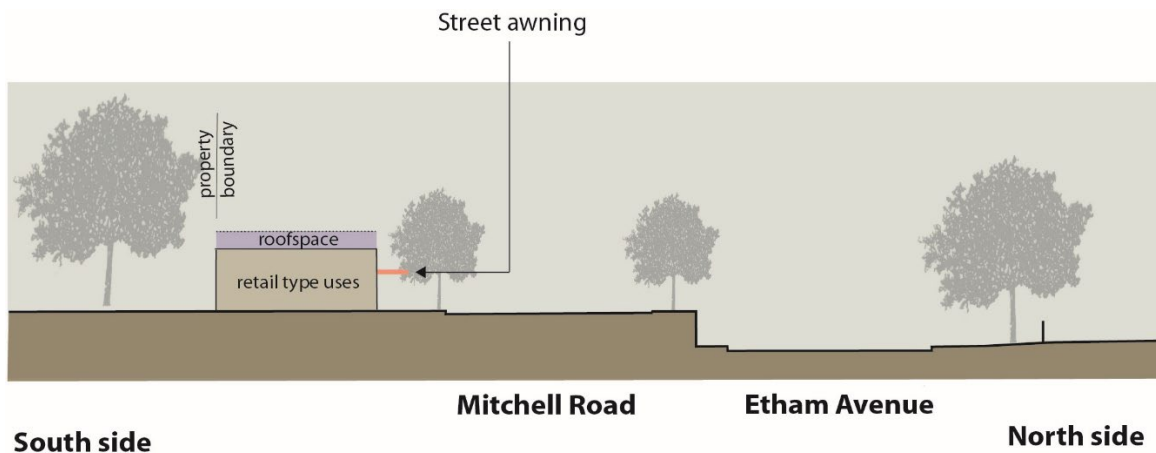
Any redevelopment of the existing shop should be in the form of a contemporary one storey building which retains the existing front setback to accommodate footpath dining. Public domain improvements, such as street trees would also enhance public amenity.

### D1.10.3 Objectives and controls

---

The street diagram illustrates some of the controls, and is to be read in conjunction with the table of objectives and controls below. Note, the maximum building height and FSR are in Woollahra LEP 2014.

**FIGURE 6** Darling Point Road section



Objectives		Local controls	
O1	To provide uses that are consistent with the desired future character of the centre.	C1	Development provides active uses, preferably a neighbourhood shop and café that meet the daily convenience needs of the local community.
O2	To ensure that the building form and scale does not detract from the Babworth House and grounds.	C2	Development provides for an interpretation of the perimeter walling to Babworth House.
		C3	Development is a maximum of one storey.
		C4	Development establishes a low scale and profile.
		C5	The roof form respects the perimeter walling to Babworth House (refer to street section diagram).
O3	To retain views to the leafy backdrop provided by the gardens of the Babworth Estate.	C6	Development maintains views of the garden of the former Babworth Estate from Darling Point Road.
O4	To protect views from the public spaces within the centre to the harbour.	C7	Development maintains the views and vista corridors towards the harbour from Goomerah Crescent.
O5	To improve the amenity of the pedestrian and outdoor dining area.	C8	Development includes all weather protection to the shop entrance (refer to street section diagram).
		C9	Development includes advanced broad canopy tree planting in the footpath to provide shade and shelter (refer to street section diagram).
		C10	Development does not include vehicular access from Mitchell Street.

# Chapter D2 Mixed Use Centres

Part D ▶ Business Centres

CHAPTER D2 APPROVED ON 27 APRIL 2015  
AND COMMENCED ON 23 MAY 2015

Last amended on 31 May 2024



---

# Chapter D2 ▶ Mixed Use Centres

## Contents

<b>D2.1</b>	<b>INTRODUCTION .....</b>	<b>1</b>
	D2.1.1 Land where this chapter applies .....	1
	D2.1.2 Development to which this chapter applies.....	2
	D2.1.3 Objectives.....	2
	D2.1.4 Relationship to other parts of the DCP.....	3
	D2.1.5 How to use this chapter.....	3
<b>D2.2</b>	<b>NEW SOUTH HEAD ROAD CORRIDOR, EDGECLIFF.....</b>	<b>5</b>
	D2.2.1 Centre character statement .....	5
	D2.2.2 Desired future character .....	7
	D2.2.3 Objectives and controls.....	8
<b>D2.3</b>	<b>ROSE BAY NORTH.....</b>	<b>11</b>
	D2.3.1 Centre character statement .....	11
	D2.3.2 Desired future character .....	13
	D2.3.3 Objectives and controls.....	13
<b>D2.4</b>	<b>ROSE BAY SOUTH.....</b>	<b>16</b>
	D2.4.1 Centre character statement .....	16
	D2.4.2 Desired future character .....	18
	D2.4.3 Objectives and controls.....	18



## D2.1 Introduction

This is Chapter D2 of the Woollahra Development Control Plan 2014 (DCP), Part D Business Centres.

This chapter contains controls for three centres, zoned MU1 Mixed Use under Woollahra Local Environmental Plan 2014 (Woollahra LEP 2014).

This chapter seeks to ensure that development has regard to its context and is compatible with the desired future character of each centre as described in this chapter.

### D2.1.1 Land where this chapter applies

This chapter applies to the following centres, as identified on the map below:

- ▶ New South Head Road Corridor, Edgecliff
- ▶ Rose Bay North, Rose Bay
- ▶ Rose Bay South, Rose Bay.





---

## D2.1.2 Development to which this chapter applies

---

This chapter applies to development that requires development consent.

A key objective of the MU1 Mixed Use zone is to integrate suitable business, office, residential, retail and other development in accessible locations so as to maximise public transport patronage and encourage walking and cycling.

The MU1 zone permits a wide range of retail premises, business premises, office premises, community facilities, restaurants and cafes and shop top housing. (Refer to Woollahra LEP 2014 for all the types of development permitted in the zone.)

## D2.1.3 Objectives

---

The objectives of this chapter are:

- 01 To support the long term retail health of the mixed use centres.
- 02 To facilitate development in a way that reflects desired future character objectives for each centre.
- 03 To preserve the small shop character where this is indicative of the traditional streetscape.
- 04 To ensure a high standard of architectural and landscape design.
- 05 To ensure that the design and siting of development is compatible with the surrounding built form.
- 06 To ensure that development enhances the visual quality and identity of the centre through well considered design, high quality materials and facade colours that do not dominate the street.
- 07 To encourage active ground floor uses that contribute to the vitality of the centre.
- 08 To encourage a complementary mix of retail, business, office and residential uses compatible with the desired future character of the centre.
- 09 To facilitate people living in mixed use developments in the centres, and provide for good residential amenity.
- 010 To provide a range and mix of dwellings that are compatible with retail and/or commercial uses.
- 011 To minimise adverse impacts of development on the amenity of adjoining and neighbouring properties.
- 012 To retain significant views and vistas.
- 013 To improve the amenity of public domain and pedestrian safety.

---

## D2.1.4 Relationship to other parts of the DCP

---

This chapter is to be read in conjunction with the other parts of the DCP that are relevant to the development proposal, including:

- ▶ Part D: Chapter D3 General Controls for Neighbourhood and Mixed Use Centres.
- ▶ Part E: General Controls for All Development - this part contains chapters on Parking and Access, Stormwater and Flood Risk Management, Tree Management, Contaminated Land, Waste Management, Sustainability, Signage and Adaptable Housing.
- ▶ Part F: Land Use Specific Controls - this part contains chapters on Child Care Centres, Educational Establishments, Licensed Premises and Telecommunications.
- ▶ Part G: Site Specific Controls - for land at 73-79 New South Head Road, Edgecliff, the provisions of this chapter are supplemented by the relevant provisions for the land in Part G on White City. The provisions of Part G prevail in the event of any inconsistency with Chapter D2.

---

## D2.1.5 How to use this chapter

---

The primary controls for the mixed use centres are contained in two chapters:

- ▶ Chapter D2 Mixed Use Centres; and
- ▶ Chapter D3 General Controls for Neighbourhood and Mixed Use Centres.

### Chapter D2 Mixed Use Centres

Each section in this chapter represents an individual centre. Applicants need only refer to the particular centre that is relevant to their site.

The controls for each centre comprise the following elements:

- ▶ map showing the extent of the centre;
- ▶ centre character statement, providing a brief description of the centre;
- ▶ desired future character objective describing the direction and outcomes to be achieved through development in the centre; and
- ▶ table of objectives and controls relating to uses, built form, amenity, the public domain, etc. The controls represent specific ways in which a development proposal can meet the objectives. A street section diagram is also provided for the Rose Bay North and Rose Bay South centres to illustrate certain controls.

The objectives and controls in this chapter are to be read in conjunction with the general controls in Chapter D3 General Controls for Neighbourhood and Mixed Use Centres.

### Chapter D3 General Controls for Neighbourhood and Mixed Use Centres

The general controls apply to all MU1 zoned land addressed in Chapter D2, regardless of the centre in which the land is located.

---

---

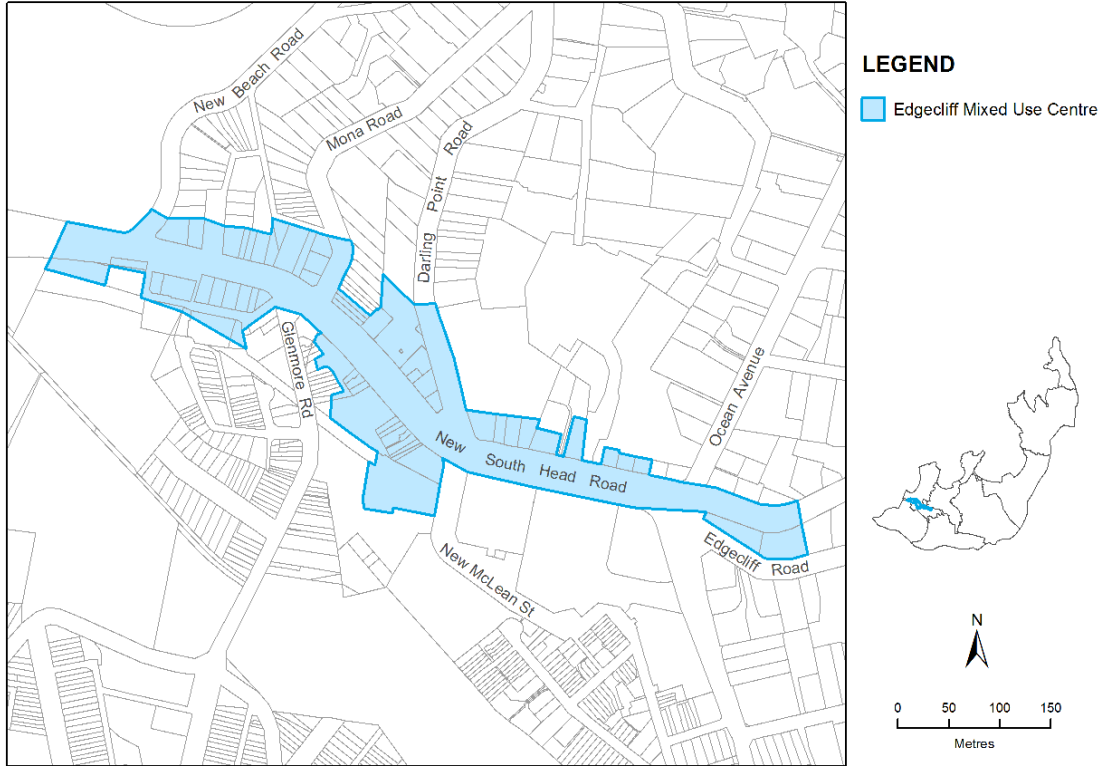
Development is required to fulfil the relevant requirements of all general controls. Unless otherwise indicated, where there is a disparity between the objectives and controls in Chapters D2 and D3, the centre specific objectives and controls in this chapter take precedence over the general controls.

Applicants need to demonstrate how their development fulfils the relevant objectives and preserves or enhances the important character elements for the centre, having particular regard to:

- ▶ surrounding building height, bulk and scale;
- ▶ any predominant architectural styles, roof forms, materials and colours;
- ▶ prevailing building lines;
- ▶ existing and proposed uses;
- ▶ landscape and vegetation features;
- ▶ topography;
- ▶ view corridors;
- ▶ pedestrian access and amenity;
- ▶ traffic and parking impacts;
- ▶ interface between the private and public domain; and
- ▶ adjacent residential areas and heritage conservation areas.

## D2.2 New South Head Road Corridor, Edgecliff

**MAP 1** Edgecliff centre map



**Notes:**

The controls in this chapter do not apply to Zone MU1 Mixed Use land on the eastern and western sides of Glenmore Road at Edgecliff; this land is located within the Paddington Heritage Conservation Area (HCA). The controls for business centres in the Paddington HCA are contained in Part C of this DCP, Chapter C1 Paddington HCA.

For land at 73-79 New South Head Road, Edgecliff, the provisions of this chapter are supplemented by the relevant provisions for the land in Part G of this DCP, regarding White City. The provisions of Part G prevail in the event of any inconsistency with this chapter.

### D2.2.1 Centre character statement

The mixed use corridor at Edgecliff applies to both sides of New South Head Road, and generally extends from New Beach Road to Edgecliff Road, excluding the land zoned E1 Local Centre between New McLean Street and Ocean Street.

The mixed use corridor developed along the tram line. Originally businesses were dependent on passing traffic, however with increased traffic volumes on street parking was replaced by transit clearways in peak periods and the retail component contracted. As a consequence, this location has tended to attract office premises, residential flat buildings, hotel accommodation, and comparison furniture or homewares stores rather than convenience retailing.

---

### Historical development

Edgecliff was extensively quarried in the early days of European settlement. The development of Edgecliff west of Ocean Street began along New South Head Road. The area was dominated for some time by the Glenrock Estate on the north side of New South Head Road, where the Ascham School is now located.

Early photographs dating from the 1860s reveal clusters of dwellings and businesses along the southern side of New South Head Road, followed by the subdivision of new areas behind the main road. Bentley's Bridge was a stone structure built to cross the watercourse which drained the valley behind Rushcutters Bay. A toll gate was established for the privilege of using New South Head Road.

In September 1894 a cable tram service opened; it operated from King Street in the city to Ocean Street in Edgecliff. The tramline was extended past Edgecliff in 1898. In 1905 the tram line was electrified, but ceased operating in 1960. Edgecliff railway station opened in 1979 when the Illawarra line was extended from Town Hall railway station to Bondi Junction.

### Built form

Development along New South Head Road includes residential flat buildings, commercial and mixed use buildings. These present a diverse mix of architectural styles as well as building heights, which range from single storey to approximately 12 storeys.

### Heritage items

Woollahra LEP 2014 identifies heritage items at 2a Mona Road and on New South Head Road (Nos. 136, 188, and 287-289). The New South Head Road corridor adjoins the Paddington HCA around Glenmore Road.

### Public parks and community facilities

There are no public parks within the New South Head Road mixed use corridor, however, Rushcutters Bay Park is located at the western end of the corridor.

### Access and circulation

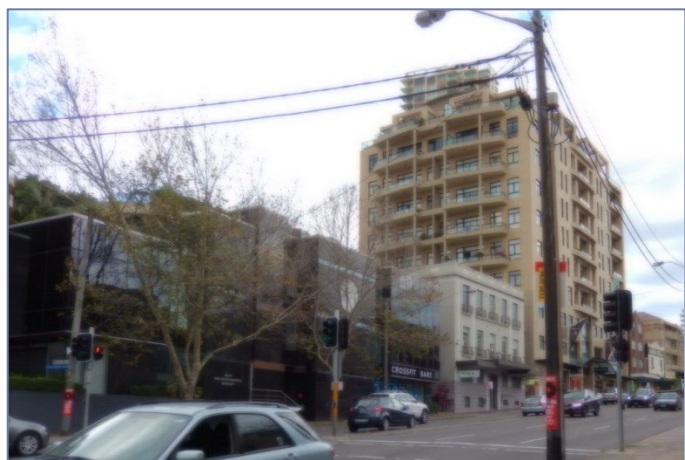
The New South Head Road mixed use corridor has excellent access to public transport. The Edgecliff train station and bus interchange is within walking distance, and the corridor contains a major road serviced by a number of bus routes.

On-street parking is limited due to transit clearways operating during peak hours. Some sites have vehicular access from a secondary street and opportunity to include on-site parking.

### Views

The centre is located on a ridgeline and has views west to the city and east to Double Bay.

---



### D2.2.2 Desired future character

This mixed use corridor is a highly urban environment and it is important that it meets high standards of visual quality and pedestrian amenity.

This part of New South Head Road is a main entry point to the Municipality and it is important that the experience and journey through the centre makes a positive impression. Everything that can be seen and experienced in the street is therefore relevant.

Development fronting New South Head Road will generally contain four to six storey mixed use buildings. Building facades, in terms of detailing and building materials, should be well designed, with particular consideration to how the buildings are interpreted from moving vehicles, so that the view driving along New South Head Road contributes to the public domain. At street level, buildings should respond to pedestrians by providing human scale design elements, interesting frontages and awnings for protection.

Development within this corridor must consider its impact on the adjoining Paddington heritage conservation area, including Glenmore Road, which is an important gateway entry to Paddington. Development should protect and respond to the character and scale of the heritage conservation area.

The New South Head Road mixed use corridor permits a range of residential and commercial land uses, including restaurants and cafes which should contribute to a more vibrant centre, particularly at night. Though certain types of convenience retailing opportunities are constrained by the restricted parking, it is expected that comparison specialist retailing, such as homewares and furniture shops, and complementary offices, such as medical suites, will capitalise on the excellent access to public transport, high visual exposure and proximity to the Sydney CBD.

### D2.2.3 Objectives and controls

Objectives		Local controls	
O1	To support the integration of appropriate retail and commercial uses with housing.	C1	The ground level contains active uses, preferably speciality retailing and personal services that do not generate high parking demand.
O2	To provide active street frontages.	C2	Offices and residential uses are generally located above street level.
O3	To promote an attractive street wall along New South Head Road.	C3	Facade design is of high aesthetic quality, and complements the form, roofline, fenestration, material, finishes and colour of adjoining buildings.
O4	To promote an urban environment which meets high standards of visual quality.	C4	Facade design incorporates similar proportions of glazed and non-glazed surfaces and achieves a balance between vertical and horizontal divisions. The extensive use of glass is avoided.
O5	To improve the relationship of buildings to the public domain.	C5	Facade elements are generally contained in vertical planes aligned with the street. Sloping facades are avoided.
		C6	Side and rear facades are the same visual quality as street facades. Large areas of blank unrelieved walls are avoided.
		C7	The design of the lower part of the street facade relates to the scale of pedestrians.
		C8	Large expanses of highly reflective, brightly coloured or black surfaces are not used on facades.
		C9	The front setback defines a coherent and consistent alignment to the public

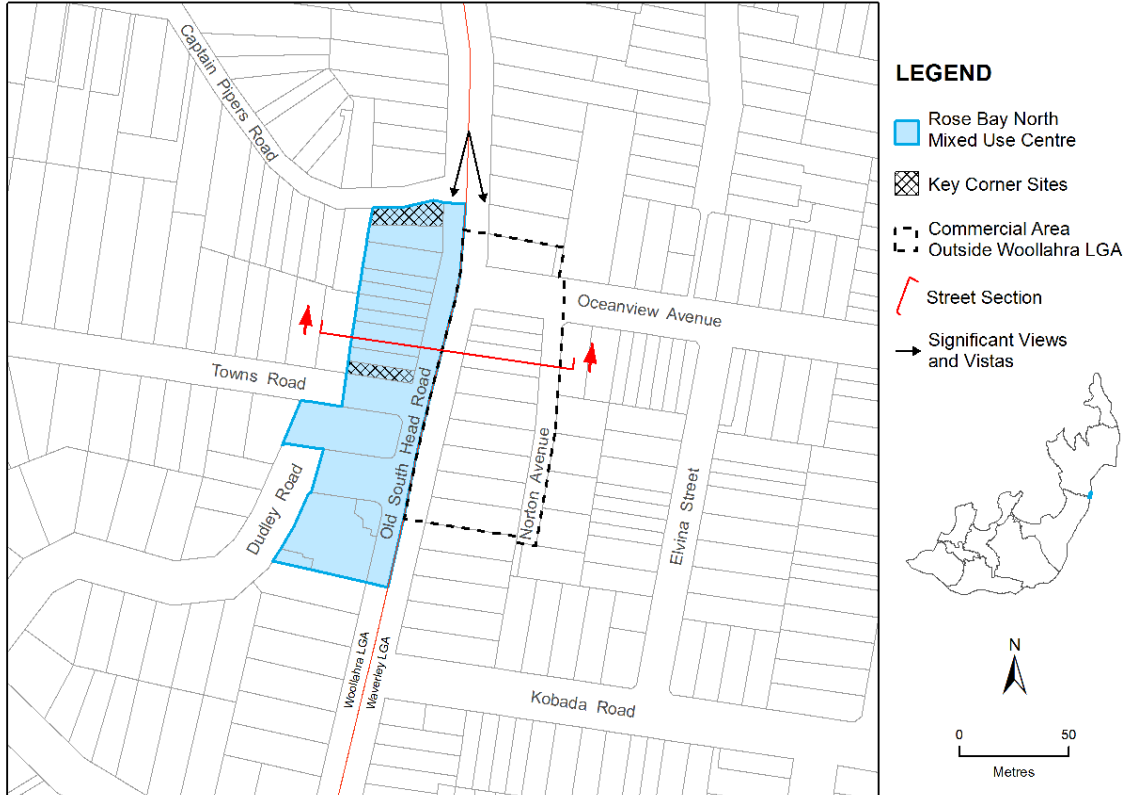
Objectives	Local controls
	<p>domain.</p> <p>Note: For land affected by the arterial road reservation, the street alignment is determined from the reservation.</p> <p>C10 Structures below ground level may be permitted underneath the setback area.</p>
<p>O6 To improve the visual quality of the streetscape and provide for attractive and comfortable pedestrian areas.</p>	<p>C11 Awnings are provided for mixed use and commercial buildings.</p> <p>C12 The design of the awnings is in harmony with the facade of the building and with other awnings in the immediate vicinity.</p> <p>C13 Awnings may be permitted above the setback area.</p> <p>C14 Public domain improvements, including street tree planting and pavement upgrading are consistent and unify the corridor.</p> <p>C15 Street tree planting and footpath works reduce the sensory impact of the traffic on New South Head Road.</p>
<p>O7 To ensure development is sympathetic to the adjoining development.</p> <p>O8 To protect access to natural light and ventilation of adjoining sites.</p> <p>O9 To provide for the amenity of occupants and adjoining residential uses.</p>	<p>C16 At ground level, the building may have a zero setback to side and rear boundaries.</p> <p>C17 A side boundary setback of at least 1.8m applies to the fifth storey and above, if relevant.</p> <p>Note: This control is relevant to sites where the maximum building height is 20.5m in the LEP.</p> <p>C18 A rear setback of 2.4m applies to all levels of the building above ground level.</p> <p>C19 A 2.4m building articulation area applies at the rear to all levels above the first floor. The articulation area is occupied by a combination of external and internal elements.</p> <p>Note: This articulation area is calculated</p>



Objectives	Local controls
	<p>from the rear setback established in C18 above.</p> <p>Note: Part D3.7 Acoustic and Visual Privacy also applies.</p>
<p>O10 To recognise the role of Glenmore Road as an important entry to Paddington and ensure that development protects and enhances the character of the adjoining heritage conservation area.</p>	<p>C20 Development on land in proximity to the adjoining heritage conservation area is in architectural harmony with the adjoining historical buildings in respect of massing, modelling of facades, fenestration and external materials, colours and finishes.</p> <p>Note: Zone MU1 Mixed Use land on Glenmore Road is located within the Paddington heritage conservation area. The planning controls for that land are in Part C of this DCP, Chapter C1 Paddington HCA.</p>
<p>O11 To ensure that signage and structures do not compromise the visual amenity of the streetscape.</p>	<p>Refer to Part E of the DCP, Chapter E7 Signage.</p> <p>Note: Advertising signage is not permitted.</p>

## D2.3 Rose Bay North

MAP 2 Rose Bay North centre map



### D2.3.1 Centre character statement

Rose Bay North shopping centre is located on Old South Head Road at the junction of the suburbs of Vaucluse, Rose Bay and Dover Heights. The business area is split between the Waverley Council area to the east of Old South Head Road and the Woollahra Council area to the west, with Old South Head Road forming the boundary between the two councils.

The centre, including the retail strip on the Waverley side, provides a reasonable range of services and facilities to meet the daily needs of local residents. In particular, it includes a Coles supermarket located on the southern side of Dudley Road in the Kings Theatre building. The traditional main street development provides a range of shops including cafés, take away food stores, grocer, chemist, bakery and newsagent.

#### Historical development

Old South Head Road was formed in 1811 to provide access to the signal station at Watsons Bay. The subdivision of larger estates into town allotments occurred in the 1920s and 1930s. The Kings Theatre was constructed on the corner of Dudley Street and Old South Head Road in 1935, and was likely to be the commercial hub at that time.

---

### Built form

Aside from the Coles supermarket located in the former Kings Theatre, the centre is characterised by two to four storey shop top buildings which address the street with continuous awnings. The scale and form of buildings is generally consistent with the buildings on the Waverley side of Old South Head Road.

### Heritage buildings

The former Kings Theatre at 694-696 Old South Head Road, built in 1935 in the Art Deco style, is a heritage item. It is a strong corner building and contributes to the character of the centre.

### Public parks and community facilities

There are no community facilities or public parks in the centre.

### Access and circulation

The centre is well serviced by buses and is located on a bike route on Towns Road and Old South Head Road.

There are opportunities for short stay parking of up to one hour on both sides of Old South Head Road.

Rear lane access for service vehicles is provided from Dudley Avenue for the Coles supermarket. Few other sites on the western side of Old South Head Road have rear lane access. To facilitate this, Woollahra LEP 2014 provides a bonus floor space ratio for corner sites between Captain Pipers Road and Towns Road if vehicular access is provided to adjoining sites.

### Views

The centre is located at the top of a south-facing slope and has a distant view of Bellevue Hill.

### Old South Head Road and Towns Road



### D2.3.2 Desired future character

The Rose Bay North centre provides a mix of residential and non-residential land uses with active street frontages that preserve and enhance the commercial viability of the centre.

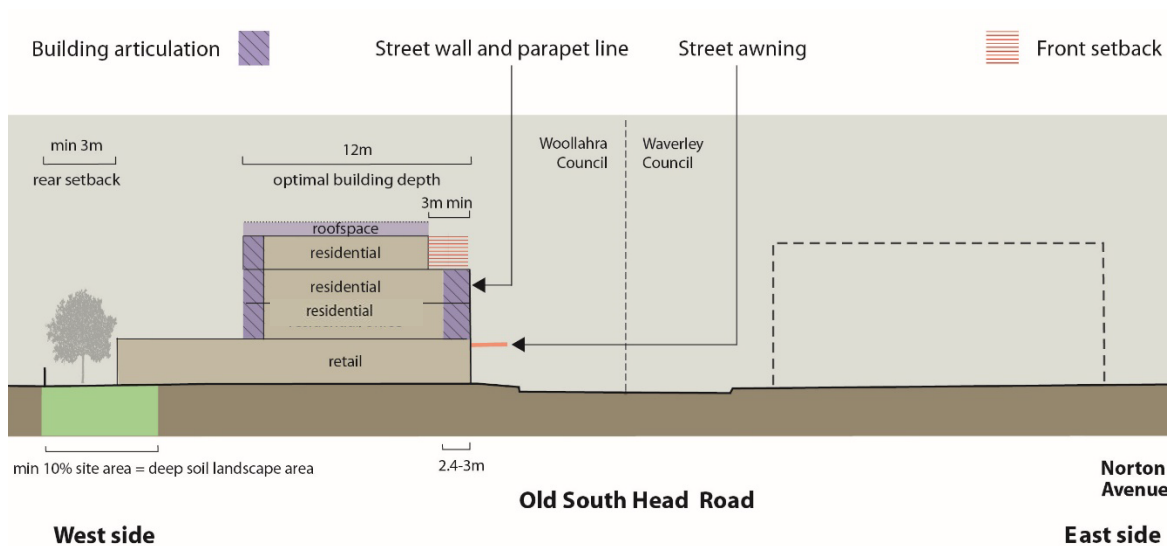
The focus for future development is on upgrading or replacing the existing building stock well designed contemporary buildings. These will be four storey mixed use developments, predominantly containing residential or office space above ground floor retailing. Buildings should address the street, in keeping with the traditional main street development pattern, and retain the continuous street awnings. The design, materials and colour schemes of new buildings is to be sympathetic to the character of the existing buildings.

Development in the Rose Bay North mixed use centre should not detract from the amenity of the adjoining Rose Bay and Vaucluse East residential centres.

### D2.3.3 Objectives and controls

The street diagram illustrates some of the controls, and is to be read in conjunction with the table of objectives and controls below. Note, the maximum building height and FSR are in Woollahra LEP 2014.

**FIGURE 1** Rose Bay North section

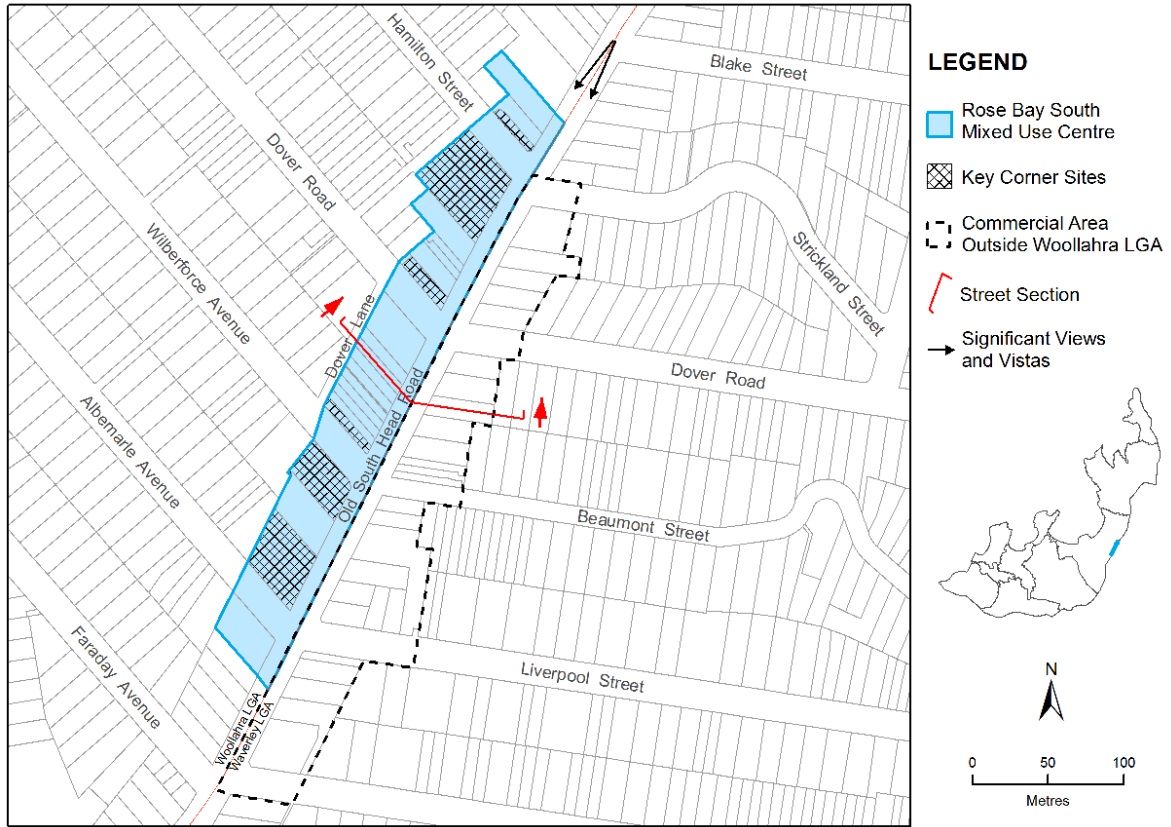


Objectives	Controls
<p>O1 To provide uses that are consistent with the desired future character of the centre.</p>	<p>C1 The ground level contains active uses, preferably retail, business and personal services that address the needs of the local community.</p> <p>C2 Offices and residential uses are generally located above street level.</p>
<p>O2 To achieve a consistent built form and presentation to the street.</p>	<p>C3 Development is a maximum four storeys.</p> <p>C4 Development provides three storeys built to the street alignment, with a continuous and consistent parapet line above.</p> <p>C5 Development on the fourth level is setback at least 3m from the street boundary.</p> <p>C6 Development includes a continuous, solid, suspended awning over the public footpath of Old South Head Road and along the secondary frontage of corner sites.</p>
<p>O3 To encourage good building design and limit building bulk.</p>	<p>C7 Building articulation at the street alignment is in the form of recessed balconies or loggia only. Elsewhere it may be in the form of verandahs, balconies, loggia or wall offsets.</p> <p>C8 At the street alignment, the depth of the recessed balconies and loggia is between 2.4m to 3m.</p>
<p>O4 To define and reinforce corner sites.</p>	<p>C9 Development on the key corner sites to Captain Pipers Road and Towns Road (as shown in the centre map above) provides four storeys built to the street alignment with a continuous and consistent parapet line above.</p> <p>Note: A bonus floor space ratio applies to these corner sites. Refer to Woollahra LEP 2014 clause 4.4B.</p>

Objectives		Controls	
O5	To encourage continuous active retail street frontages.	C10	Development does not include vehicular access from Old South Head Road.
O6	To provide for the amenity of occupants and adjoining properties.	C11	The building depth for storeys above the ground floor level is generally not more than 12m.
		C12	The building is setback from the rear boundary by at least 3m.
		C13	At least 10% of the site is provided as deep soil landscaped area.

## D2.4 Rose Bay South

MAP 3 Rose Bay South centre map



### D2.4.1 Centre character statement

Rose Bay South mixed use centre is less than 2km from the Rose Bay local centre travelling east along Dover Road. It extends over at least four blocks along Old South Head Road. The centre provides a good mix of services including a range of health services for local residents, as well as a number of shops serving the cultural requirements of the local community.

As with Rose Bay North, the mixed use centre is split between Woollahra and Waverley Council areas. The traditional main street development provides a broad range of shops including cafés, take-away food stores, hair dresser, a church and a petrol station.

#### Historical development

Old South Head Road was formed in 1811 to provide access to the signal station at Watsons Bay. The tram was extended along Old South Head Road in 1903, and this was followed by the subdivision of larger estates into town allotments in the 1920s and 1930s. The Rose Bay Uniting Church and hall at the corner of Dover Road and Old South Head Road was constructed in 1924.

### Built form

The centre contains a mix of architectural styles, but is generally characterised by two to four storey shop top housing, with buildings addressing the street with continuous awnings.

The building stock between Wilberforce and Hamilton Streets was largely constructed in the Inter-War period and is characterised by strong rectilinear parapet lines, continuous awnings and shopfronts built to the street alignment.

### Public parks and community facilities

The church, adjacent hall and the kindergarten are a focus for community activity.

### Access and circulation

The centre is well serviced by buses and is located on a bike route along Old South Head Road.

There are opportunities for short stay parking of up to one hour on both sides of Old South Head Road.

Rear lane access for service vehicles is available between Wilberforce Avenue and Dover Road, and from Short Lane off Hamilton Street. To address this, Woollahra LEP 2014 provides a bonus floor space ratio for corner sites if vehicular access is provided to adjoining sites.

### Views

The centre is located on a south-west facing slope and has a distant view of Bellevue Hill.

### Old South Head Road





## D2.4.2 Desired future character

The Rose Bay South centre provides a good mix of cafés and restaurants and personal services to address the local community’s needs.

As with the Rose Bay North mixed use centre, the existing building stock is due for upgrading or replacement. The focus for future development is on upgrading or replacing the existing building stock with well designed contemporary buildings. These will take the form of four storey mixed use development containing residential or office space above ground floor retailing.

Buildings should be built to the Old South Head Road street alignment, address the street, and provide continuous street awnings. Redevelopment of the southern corner of Wilberforce Avenue at 498 Old South Head Road provides a significant opportunity to create a strong corner building built to the street alignment and a consistent parapet line to 494-496 Old South Head Road.

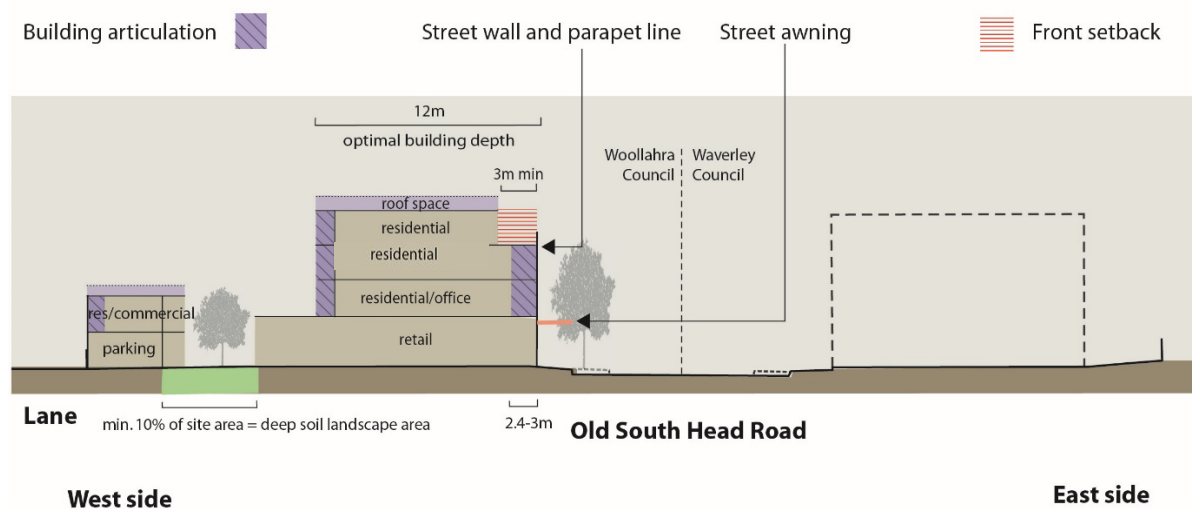
The Uniting Church at 518A Old South Head Road provides a local landmark at the Dover Road intersection.

Development in the Rose Bay South mixed use centre must not detract from the amenity of the adjoining Rose Bay residential centre.

## D2.4.3 Objectives and controls

The street diagram illustrates some of the controls, and is to be read in conjunction with the table of objectives and controls below. Note, the maximum building height and FSR are in Woollahra LEP 2014.

**FIGURE 2** Rose Bay South section



Objectives		Local controls	
01	To provide uses that are consistent with the desired future character of the centre.	C1	The ground level contains active uses, preferably retail, business and personal services that address the needs of the local community.
		C2	Offices and residential uses are generally located above street level.
02	To achieve a consistent built form and presentation to the street.	C3	Development is a maximum four storeys.
		C4	For street wall and parapet line, development provides three storeys built to the street alignment, with a continuous and consistent parapet line above.
		C5	Development on the fourth level is setback at least 3m from the street boundary.
		C6	For the street awning, development includes a continuous, solid, suspended awning over the public footpath of Old South Head Road and along the secondary frontage of corner sites.
03	To achieve a consistent built form along Dover Lane.	C7	Development is a maximum two storeys and 7m height built to the lane.
04	To support the evolution of building styles through the introduction of well designed contemporary buildings.	C8	Building articulation at the street alignment is in the form of recessed balconies or loggia only. Elsewhere it may be in the form of verandahs, balconies, loggia or wall offsets.
05	To encourage good building design and limit building bulk.	C9	At the street alignment, the depth of the recessed balconies and loggia is between 2.4m to 3m.
06	To define and reinforce corner sites.	C10	Development on corner sites provides four storeys built to the street alignment with a continuous and consistent parapet line above.
07	To support redevelopment of the key site at the intersection Wilberforce Avenue and Old South Head Road.		

---

Objectives		Local controls	
O8	To encourage continuous active retail street frontages.	C11	Development does not include vehicular access from Old South Head Road.
O9	To provide for the amenity of occupants.	C12	The building depth for storeys above the ground floor level is generally not more than 12m.
		C13	At least 10% of the site is provided as deep soil landscaped area.

# Chapter D3 General Controls for Neighbourhood and Mixed Use Centres

Part D ► Business Centres

CHAPTER D3 APPROVED ON 27 APRIL 2015  
AND COMMENCED ON 23 MAY 2015

Last amended on 31 May 2024



# Chapter D3 ▶ General Controls for Neighbourhood and Mixed Use Centres

## Contents

<b>D3.1</b>	<b>INTRODUCTION .....</b>	<b>1</b>
	D3.1.1 Land where this chapter applies .....	1
	D3.1.2 Relationship to other parts of the DCP.....	1
	D3.1.3 How to use this chapter.....	3
<b>D3.2</b>	<b>USES.....</b>	<b>4</b>
<b>D3.3</b>	<b>STREET CHARACTER .....</b>	<b>6</b>
<b>D3.4</b>	<b>BUILT FORM .....</b>	<b>9</b>
<b>D3.5</b>	<b>BUILDING ARTICULATION .....</b>	<b>15</b>
<b>D3.6</b>	<b>HERITAGE AND CONTRIBUTORY BUILDINGS .....</b>	<b>18</b>
<b>D3.7</b>	<b>ACOUSTIC AND VISUAL PRIVACY .....</b>	<b>20</b>
<b>D3.8</b>	<b>LANDSCAPED AREA AND PRIVATE OPEN SPACE.....</b>	<b>24</b>
<b>D3.9</b>	<b>CAR PARKING AND VEHICULAR ACCESS.....</b>	<b>26</b>
<b>D3.10</b>	<b>SITE FACILITIES .....</b>	<b>30</b>



## D3.1 Introduction

This is Chapter D3 of the Woollahra Development Control Plan 2015 (DCP), Part D Business Centres.

This chapter contains controls for twelve centres, zoned either E1 Local Centre or MU1 Mixed Use under the Woollahra Local Environmental Plan 2014 (LEP).

The controls in this chapter must be read in conjunction with the controls in Chapter D1 Neighbourhood Centres and Chapter D2 Mixed Use Centres.

### D3.1.1 Land where this chapter applies

This chapter contains controls for the following centres, as identified on Map A (see next page):

- ▶ Hoptoun Avenue, Vaucluse;
- ▶ South Head Roundabout, Vaucluse;
- ▶ Vaucluse Shopping Village, Vaucluse
- ▶ Plumer Road, Rose Bay;
- ▶ O'Sullivan Road, Rose Bay;
- ▶ Streatfield Road, Bellevue Hill;
- ▶ Bellevue Hill Shops, Bellevue Hill;
- ▶ Manning Road, Woollahra;
- ▶ Darling Point Road, Darling Point;
- ▶ New South Head Road Corridor, Edgecliff;
- ▶ Rose Bay North, Rose Bay; and
- ▶ Rose Bay South, Rose Bay.

### D3.1.2 Relationship to other parts of the DCP

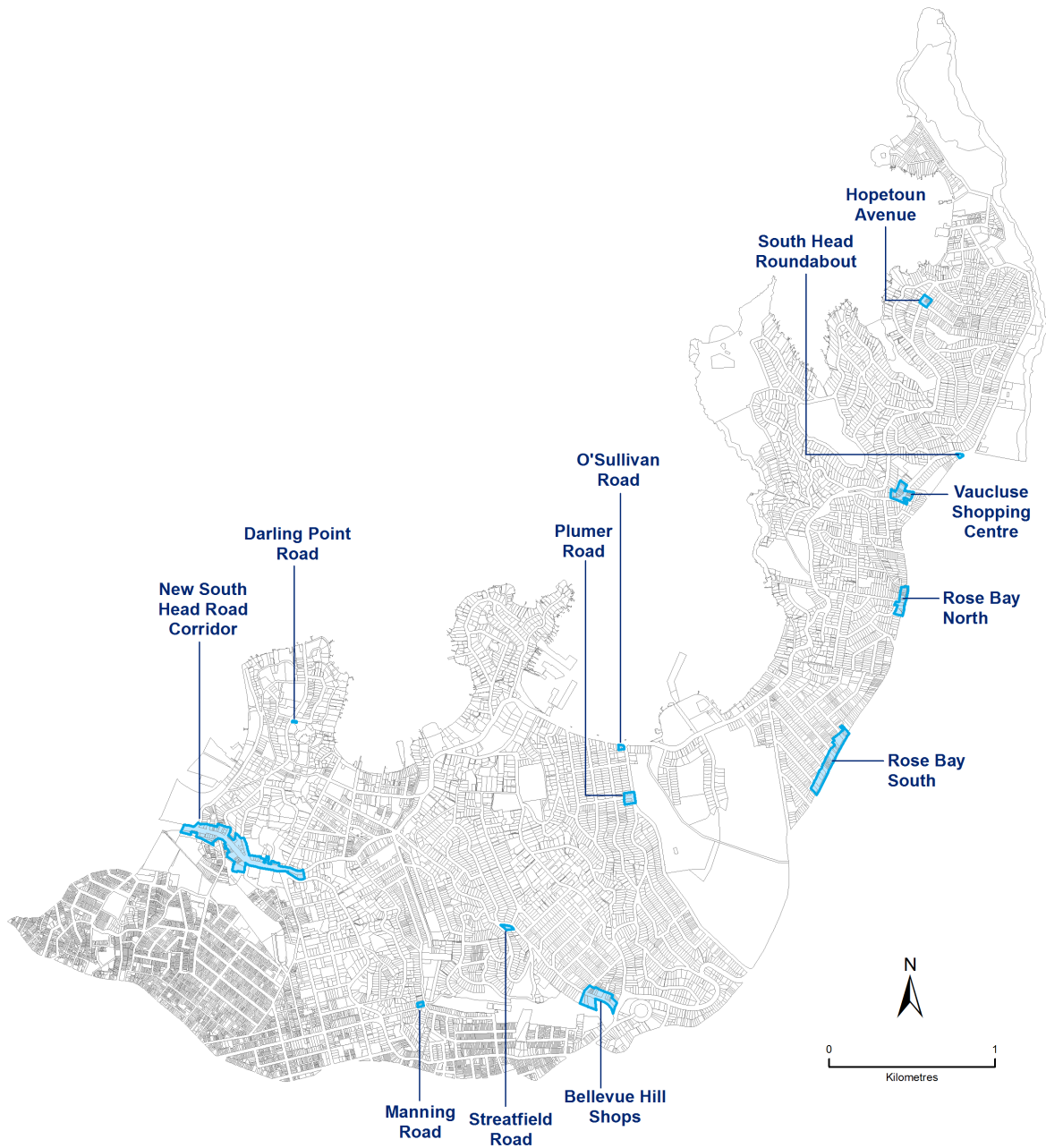
This chapter is to be read in conjunction with the other parts of the DCP that are relevant to the development proposal, including:

- ▶ Part B: Chapter B3 General Development Controls, but only if the proposal relates to an Inter-War flat building (refer to Section B3.8 Additional controls for development other than dwelling houses).
- ▶ Part D: Chapter D1 Neighbourhood Centres OR Chapter D2 Mixed Use Centres, depending on the location of the proposed development.
- ▶ Part E: General Controls for All Development - this part contains chapters on Parking and Access, Stormwater and Flood Risk Management, Tree Management, Contaminated Land, Waste Management, Sustainability, Signage and Adaptable Housing.



- ▶ Part F: Land Use Specific Controls - this part contains chapters on Child Care Centres, Educational Establishments, Licensed Premises and Telecommunications.

**MAP A** Land where Chapter D3 applies



### D3.1.3 How to use this chapter

---

This chapter establishes controls for:

- ▶ uses;
- ▶ street character;
- ▶ built form;
- ▶ building articulation;
- ▶ heritage and contributory buildings;
- ▶ acoustic and visual privacy;
- ▶ landscaped area and private open space;
- ▶ car parking and vehicular access; and
- ▶ site facilities.

The controls in this chapter comprise the following elements:

- ▶ Explanation of the topic:  
This provides background information on why the topic is important and how it is relevant to building design. The explanation helps determine how the general controls should be applied to development.
- ▶ Table of objectives and controls:  
The objectives describe the outcomes that proposed development is required to achieve. Applicants need to demonstrate how their development fulfils the relevant objectives for each topic. The controls represent specific ways in which a development proposal can meet the objectives. The intent of the controls must be interpreted in the context of the topic's objectives.

Development is required to address all the relevant controls. Where there is a disparity between these general controls and the centre specific controls in Chapters D1 and D2, the centre specific controls take precedence over the general controls.

## D3.2 Uses

Land zoned E1 Local Centres and MU1 Mixed Use generally consists of a mix of small scale shops and commercial premises at street level with residential dwellings or offices above.

Centres with continuous ground level retail frontage offer the benefits of safety, commercial activity and street life. Incorporating housing on the upper levels can also make a significant contribution to the local character, provide street surveillance and contribute to night time activity in the centres.

Objectives		Controls	
O1	To promote a mix of residential and non-residential land uses that helps preserve the commercial viability of centres	C1	At ground floor, the building is designed for retail or other active uses on the primary street frontage.
O2	To maintain continuous retail or commercial uses at street level.	C2	Residential uses on the ground floor are limited to areas providing access to residential uses above, or areas to the rear of the retail or other active uses. These areas for residential use must not compromise the achievement of active street frontages, or the commercial viability of the ground floor area that provides the active street frontage.
O3	To ensure that buildings and spaces are designed to be durable and adaptable.	C3	At the first floor, the building is generally designed to accommodate residential uses.
		C4	At the second floor and above, the building is designed to accommodate residential uses.
		C5	Development provides a range of residential accommodation types and forms (such as multi-level dwellings on the upper storeys).
O4	To encourage activities are compatible with mixed use developments that contain residential.	C6	The land use is consistent with the desired future character of the centre.
		C7	Development minimises conflict between the functional and access demands of residential and non-residential occupants.

Objectives	Controls
O5 To preserve the small shop character of neighbourhood centres.	C8 The commercial frontage at street level for individual commercial and retail units matches the traditional subdivision pattern.  C9 Commercial and retail premises less than 200m <sup>2</sup> have a depth to width ratio between 1:1 and 3:1.

### D3.3 Street character

The streetscape refers to the collection of visible elements that form the street, including the form and treatment of buildings, setbacks, fences and walls, landscaping and trees, driveway and street layout and surfaces, utility services and street furniture such as lighting, signs, barriers and bus shelters.

Streetscape quality helps to provide local amenity and identity. Good quality street environments are particularly important in our business centres where the community gathers and interacts. Safeguards are needed to ensure that the streetscape qualities of new development are compatible with the desired future character of the centre.

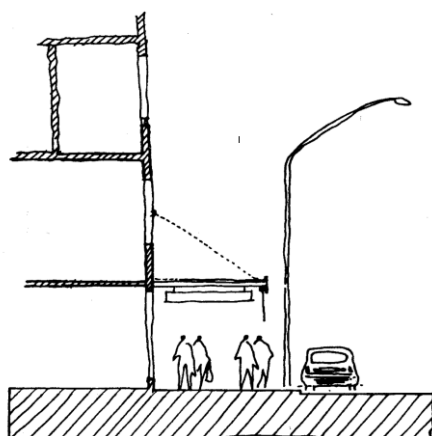
Good development contributes to a cohesive streetscape and desirable pedestrian environment. New development should recognise predominant streetscape patterns, such as building form, roof design, front setbacks, awnings and predominant materials to ensure a cohesive streetscape character.

Creating attractive and lively street environments can help to slow traffic, foster the use of streets as places for social interaction and encourage pedestrian and cyclist activity.

Objectives		Controls	
O1	To ensure development contributes to active and desirable pedestrian environments.	C1	The building is located as close to the street alignment as possible to promote interaction between pedestrians and shopfronts.
O2	To create an active interface between ground level retail or commercial properties and the street.	C2	Development includes display windows with clear glazing to ground floor retail and commercial premises, with a maximum sill height of 0.7m.
		C3	The building has a clear street address and the entry to upper level development is well defined at the street frontage.
		C4	Access to upper level uses does not occupy more than 20% of the ground floor frontage.
		C5	Vehicle access is not off the active street frontage. Vehicular entries are from a secondary street, are discrete and minimise conflicts with pedestrians.

Objectives		Controls	
03	To ensure development contributes to cohesive streetscapes.	C6	Development continues the predominant built form character of the street, including front setbacks, awnings, parapet lines, floor to ceiling heights and roof pitches.
04	To ensure development responds to predominant streetscape qualities and contributes to the desired future character of the centre.	C7	Development maintains the predominant balance of horizontal and vertical proportions in the street.
		C8	Development to re-use an existing building reinstates missing façade elements and decorative details.
		C9	The design of the building facade uses materials that are compatible with the existing development context.
06	To ensure that the colour of the building facade is not intrusive or unreasonably dominant within the streetscape, and is compatible with the desired future character of the centre.	C10	The external painting of a building in bright colours, corporate colours or fluorescent colours is avoided.
		C11	Any individual business branding and identity in external painting and colour schemes is subordinate to the main colour schemes in the street. Note: Also refer to the signage controls in Part E7 of the DCP, Section 7.2.2 When external painting of a building constitutes a wall sign.
07	To provide an attractive and comfortable pedestrian environment.	C12	Development provides awnings as indicated for each centre in Chapter D1 or D2 and the street sections where relevant.
		C13	Awning design is a solid suspended steel box type section, with a minimum soffit height of 3.2m.
		C14	Awning height provides continuity with adjoining properties, follows the street grade, and is of sufficient depth to provide good shade and shelter to pedestrians (see Figure 1 below).

Objectives	Controls
	<p>C15 Under awning lighting is included; either recessed into the soffit of the awning or wall mounted on the building.</p> <p>C16 Development protects existing street trees and includes streetscape improvements.</p> <p>C17 Development includes advanced tree planting in the footpath.</p>
<p>O8 To ensure a safe environment by promoting crime prevention through design.</p>	<p>C18 Building design incorporates windows to overlook the public domain on all street frontages.</p> <p>C19 Security features at ground level complement the design of the façade and allow window shopping and the spill of light into the street out of business hours.</p> <p>C20 Building design avoids dead edges at ground floor level, such as car parking frontages, blank walls and recessed spaces.</p>
<p>O9 To ensure that signage and structures do not compromise the visual amenity of the streetscape.</p>	<p>C21 Refer to Part E of the DCP, Chapter E7 Signage.</p>



**FIGURE 1** Awning design – suspended steel box section type with a minimum soffit height of 3.2m

## D3.4 Built form

The building height, floor space ratio (FSR) and setbacks establish the building envelope. The built form of the development sits within the envelope and is moulded to respond to the site context.

The maximum building height and FSR are set by Woollahra LEP 2014. This part of the DCP contains front, side and rear setbacks and articulation controls, as well as design guidelines for streetscape presentation, roof forms and amenity.

The maximum floor space ratios in Woollahra LEP 2014 are not “as of right”. To achieve the maximum permissible floor space ratios, a development should satisfy the relevant controls applicable to the land.

The gross floor area of a development is to be contained wholly within the building envelope generated by the maximum building height in Woollahra LEP 2014 and the controls for building footprint, building storey height, and front, side and rear setbacks specified in this chapter of the DCP.

The permissible gross floor area for each site is generally 80% of the theoretical floor space achievable within the building envelope. The 20% balance allows for building articulation and design elements which contribute to well designed buildings and allow for design flexibility to address amenity issues for both existing and new buildings.

The desired built form for the E1 Local and MU1 mixed use centres is illustrated in the street sections (in Parts D2 and D3). These have been prepared having regard to the following key characteristics of the centres:

- ▶ Buildings are generally row buildings with the massing concentrated to the street frontage. Typically built from side boundary to side boundary along the street frontage, clearly defining the edges of the street. In many centres strong corner buildings provide termination to the row and emphasise the corner.
- ▶ Built form at the rear of the sites is generally less bulky and provides a transition to residential sites.
- ▶ Articulated parapets and hipped roof forms contribute to the urban character.

The built form controls in the DCP accommodate a mix of uses in the centres. The deep ground level floorplates are suitable for retail and commercial uses, whilst the upper level floorplates provide for more natural light and ventilation, and are suitable for residential uses.

Car parking above ground is not encouraged. If car parking is proposed at or above ground level (i.e. within the building envelope) the development may not achieve its maximum permissible floor space. Council will not support a larger building envelope to provide for additional floor space.



Objectives		Controls	
O1	To achieve a built form of a scale and character in keeping with the desired future character of each centre.	C1	Development complies with the street section drawings for the centres in Chapter D1 and D2.
O2	To relate new development to existing building lines and grades along the street frontage.	C2	The design of the building footprint minimises cut and fill, and establishes ground floor levels that generally correspond to those of adjoining buildings.
		C3	The building achieves, but does not exceed, the height along the primary street frontage identified in the street sections in Chapter D1 and D2.
		C4	The floor to ceiling height of ground floor development is at least 3.6m, to allow for changes in tenancy.
		C5	Development complies with front setbacks identified in the street sections in Chapter D1 and D2.
		C6	The front setback defines a coherent and consistent alignment to the public domain and accentuates street corners.
		C7	Where an upper level setback is required, that setback alignment is parallel to the street boundary alignment.
		C8	A rear setback of at least 3m, increasing by a minimum of 1.5m for each level above ground floor level, is provided if the rear of the site adjoins land zoned for residential or public open space purposes.
		C9	Where development is permitted along rear lanes, it does not exceed a wall height of 7.2m.
		C10	A side setback of at least 1.5m applies at all levels above 2 storeys, where the side setback immediately adjoins residential zoned land.

Objectives	Controls
	<p>C10 do not apply, instead refer to Chapter D2 Mixed Use Centres.</p> <p>C11 Rear setbacks provide:</p> <ul style="list-style-type: none"> <li>a) vehicle access to the rear of lots (where practical); and</li> <li>b) deep soil landscaped areas where blocks adjoin residential areas or public open space.</li> </ul> <p>C12 Pergolas, sunscreens, privacy screens or planters or the like, must not:</p> <ul style="list-style-type: none"> <li>a) increase building bulk;</li> <li>b) exceed the maximum building height;</li> <li>c) significantly affect views from adjoining properties, the immediate vicinity or from nearby ridges.</li> </ul>
<p>O3 To protect solar access to adjoining residential zoned land in winter.</p>	<p>C13 Where already existing, access to sunlight is maintained for a minimum period of two hours between 9am and 3pm to private open space of adjoining properties. Where existing overshadowing is greater than this, access to sunlight is not further reduced by new development.</p>
<p>O4 To protect significant views and vistas.</p>	<p>C14 Development maintains the significant views and vistas identified on the maps for the centres in Chapter D1 and D2.</p>
<p>O5 To encourage building massing and articulation that creates strong corner buildings.</p>	<p>C15 If a corner building, the design reflects the street geometry, topography, sight lines and skyline elements.</p> <p>C16 Street corners are strengthened by massing and building articulation to both frontages.</p> <p>C17 Development on a corner site achieves the maximum prescribed height to both frontages.</p>

Objectives	Controls
	<p>Note: Bonus floor space ratio applies to some corner sites to encourage development of prominent corner buildings. Refer to Woollahra LEP 2014 clause 4.4B.</p>
<p>O6 To promote building forms that provide quality internal environments and allow natural day lighting, natural ventilation and visual and acoustic privacy to dwellings.</p>	<p>C18 Habitable rooms have a minimum floor to ceiling height of at least 2.7m.</p> <p>C19 Development for residential uses generally provides a building depth up to 12m including the articulation zones. Where building depth exceeds 12m, the applicant must demonstrate how satisfactory daylight and natural ventilation is to be achieved.</p> <p>C20 Development includes courtyards at ground and first floor level to provide natural lighting and ventilation. Light wells as the main source of lighting and ventilation to dwellings are avoided.</p> <p>C21 Primary door and window openings in residential living areas are located towards the street and/or rear lane and protect privacy. Living areas with primary openings that face a shared side boundary are avoided.</p> <p>C22 Roof terraces adjoin habitable space that is on the same floor level. Development does not include a rooftop terrace that is only accessed from a stairway and/or lift.</p>
<p>O7 To encourage roof design that creates a distinctive silhouette to buildings.</p> <p>O8 To ensure that plant and service equipment on roofs is not visually intrusive.</p>	<p>C23 The floor level of the uppermost habitable storey is 3.5m or more below the maximum building height to accommodate a roof form that is visually interesting and articulated.</p> <p>C24 The profile and silhouette of the parapet, eaves and roof top elements are integrated in the roof design.</p>

Objectives	Controls
	<p>C25 Where a pitched roof is proposed, the angle of the pitch is compatible with the existing development context.</p> <p>Note: The building form including parapet and plant and lift overruns must be contained within the envelope height. Refer to LEP definition of building height.</p> <p>C26 Communication devices, antennae, satellite dishes, chimneys, flues and the like are not readily visible from the public domain.</p>
<p>O9 To ensure that the use of glazing does not cause unreasonable glare.</p>	<p>C27 The building or its façade does not result in glare that causes discomfort or threatens safety of pedestrians or drivers.</p> <p>Note: A reflectivity report analysing potential glare from the proposed new development on pedestrians or motorists may be required to be submitted with the development application.</p>
<p>O10 To ensure that the significant characteristics of Inter-War flat buildings are retained and protected.</p>	<p>C28 If development relates to an Inter-War flat building, the additional controls for Inter-War flat buildings in Part B, Chapter B3 General Development Controls of this DCP also apply (refer to Section B3.8 Additional controls for development other than dwelling houses)</p> <p>.</p>

Objectives	Controls
<p>O11 To ensure no adverse geotechnical or hydrogeological impacts on any surrounding property and infrastructure as a consequence of the carrying out of development.</p>	<p>C29 Excavation below 2m and/or within 1.5m of the boundary is accompanied by a geotechnical report and a structural report to demonstrate that the works will not have any adverse effect on the neighbouring structures.            Note: Council may identify other circumstances where these reports are required. All reports must be prepared in accordance with Council’s guidelines. Council may also require the preparation and submission of a pre-commencement dilapidation report for properties neighbouring the development.</p>
<p>O12 Housing and buildings are to be accessible and useable by all people in the community, including people with disabilities.</p>	<p>Refer to the <i>Disability (Access to Premises - Buildings) Standards 2010</i>, National Construction Code, and Part E of this DCP, Chapter E8 Adaptable Housing.</p>

## D3.5 Building articulation

Building articulation refers to the three dimensional modelling of a building façade. Building articulation along the street frontage establishes the relationship between a building and the street, through the use of elements like wall offsets, entry porches, loggias, balconies and bay windows.

Traditionally, buildings in the Zone E1 Local Centres and Zone MU1 Mixed Use are built to the street alignment with recessed balconies on the upper levels.

Articulation zones allow for the design of accessible and comfortable private outdoor living areas, which contribute to the liveability of residential dwellings located in business centres.

The articulation zones, through the combination of internal and external elements, also provide for more interesting and well designed buildings. Internal elements include habitable rooms, entries, bay windows and glazed balcony. External elements within the area for building articulation include balconies, terraces, verandahs, loggias, decks, porches, external access stairs, solar protection elements such as roof overhangs, external louvered walls, screens, awnings and deep reveals, decorative architectural elements such as corbelling, projecting sills and expressed window openings.

The street section drawings in Chapters D1 and D2 of this DCP identify the area for building articulation for some centres.

Objectives		Controls	
O1	To create a strong street address and enrich the character of the centre through appropriate building articulation.	C1	Building articulation is provided as indicated in the street sections for the centres in Chapter D1 and D2 of the DCP.
O2	To encourage good building design and limit building bulk through articulation.	C2	The building at the street elevation is significantly articulated to provide depth and interest to the building form. The building articulation area includes a combination of external and internal elements.
		C3	Building design responds to environmental conditions such as orientation, noise, privacy and views, natural ventilation and solar access.
		C4	The façade is richly articulated and expresses the different levels of the building and/or its functions.
		C5	Architectural detailing and balconies do not project more than 500mm beyond the prevailing building line.
		C6	Where boundary walls are visible, these include modelling. Blank boundary walls are avoided.



**FIGURE 2** Recessed balcony



**FIGURE 3** Part projecting balcony



## D3.6 Heritage and contributory buildings

Council supports the conservation of the rich mixture of buildings and places of special significance within the municipality. Woollahra LEP 2014 contains controls for the conservation of heritage items and heritage conservation areas (HCA). Development involving a heritage item or located within a HCA must also comply with the provisions in the LEP.

In addition to the heritage items, there are contributory buildings in heritage conservation areas. These are buildings that are notable, of architectural merit, may belong to a group of buildings that together define a street corner, are well built using quality materials, or have distinguished features that remain substantially intact.

The contributory buildings are identified in the descriptions of each centre in Chapters D1 and D2.

Council promotes historic continuity to maintain the local identity of our neighbourhood and mixed use centres. Development should seek to retain these buildings and enhance their architectural features.

Development involving a heritage item, or contributory building, will require a statement of heritage impact to be lodged with the development application.

Objectives		Controls	
O1	To protect and enhance items of heritage significance and contributory buildings.	C1	The significance of the heritage item or contributory building is not compromised by the proposed development, particularly in regards to building bulk, scale, design, setbacks, external colours and finishes.
O2	To ensure development conserves or enhances items and areas of special architectural, social, cultural or historic interest.	C2	The upgrade or re-use of the heritage item or contributory building retains and enhances the architectural and streetscape value of the building.
O3	To encourage ensure that contributory buildings are retained and adaptively reused in a manner that respects the significance of the building.	C3	Development involving the re-use of a contributory building reinstates missing façade elements and decorative details.
		C4	Demolition of a contributory building is avoided.  Note: Council discourages the demolition of contributory buildings. An application to demolish a contributory building must clearly demonstrate that development would provide a replacement building of higher quality (than the contributory building) with respect to streetscape

Objectives	Controls
	<p>character, architectural design, internal and external amenity, flexibility of uses, material quality and construction.</p> <p>Also refer to Woollahra LEP 2014 for development involving a heritage item.</p>
<p>O4 To support new building design that responds to, and complements, the form and character of heritage and contributory buildings.</p>	<p>C5 Development adjacent to a heritage item or contributory building is sympathetic in scale, alignment, detailing and materials.</p> <p>Note: Also refer to Woollahra LEP 2014 for development in the vicinity of a heritage item.</p>

## D3.7 Acoustic and visual privacy

Privacy is a major determinant of the ability of residents and neighbours to enjoy their home. Privacy refers to both acoustic and visual privacy. The privacy needs of residents and neighbours should influence all stages of design, from the location of dwellings and the placement of windows and private open space through to the selection of materials and construction techniques.

Visual privacy can be achieved by:

- ▶ layout that avoids overlooking;
- ▶ screening; and
- ▶ separation.

The level of acoustic privacy depends on the location and design of habitable rooms relative to noise sources such as common areas in the development, restaurants and cafes, late trading hours and major roads.

Residential accommodation in mixed use areas is likely to be subject to a certain level of activity noise associated with the uses that mixed use business areas accommodate such as cafes, restaurants and late trading hours. The resulting amenity impacts can be substantially mitigated by good design.

Council may require a Noise Impact Assessment as part of the development application to identify potential noise impacts and demonstrate how noise will be managed.

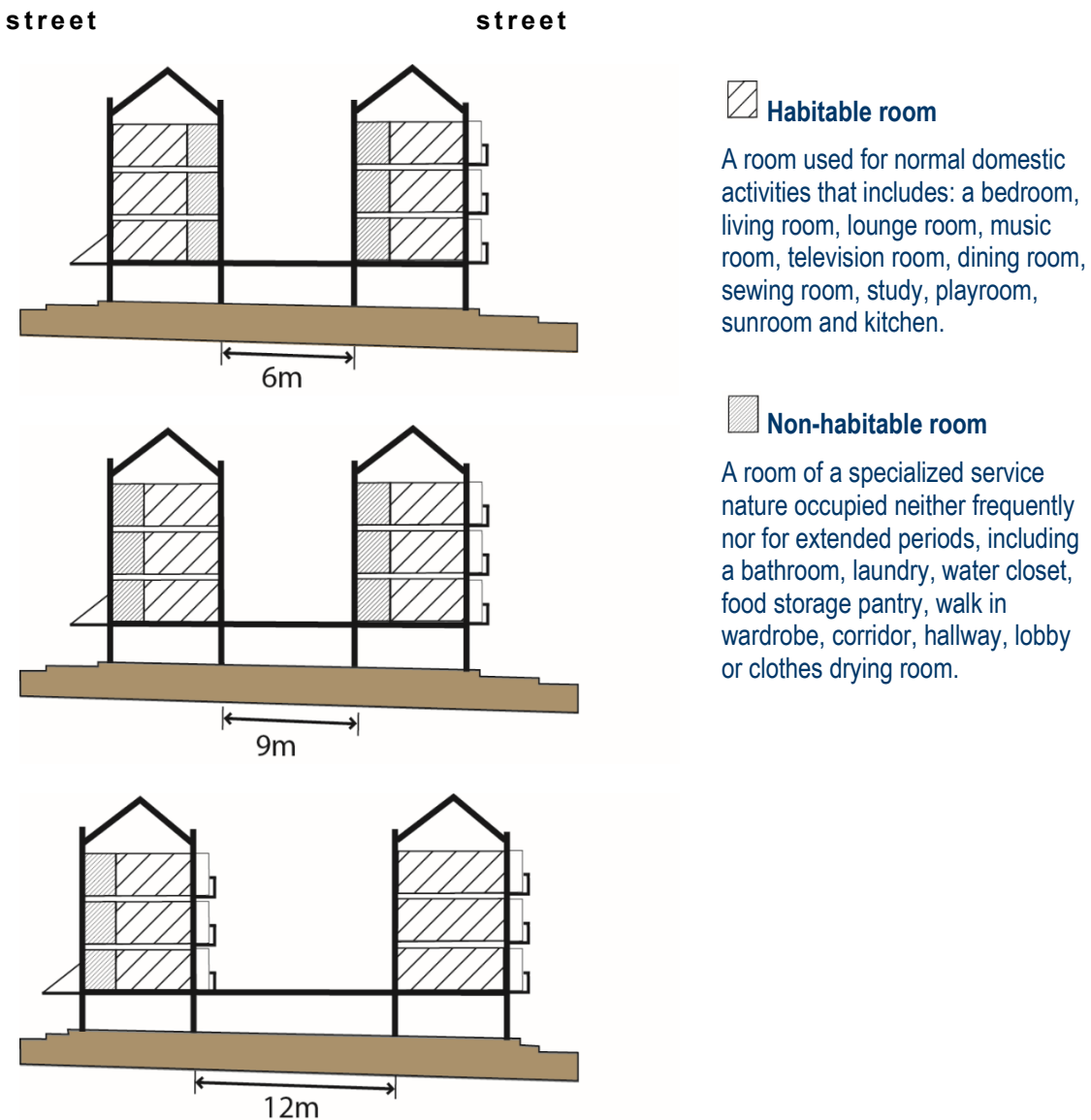
Objectives		Controls	
O1	To ensure adequate separation between dwellings for acoustic and visual privacy.	C1	Where a development involves two or more separate buildings the minimum distance between windows facing each other is: <ul style="list-style-type: none"> <li>a) 6m between non-habitable rooms;</li> <li>b) 9m between habitable and non-habitable rooms; and</li> <li>c) 12m between habitable rooms.</li> </ul> Refer to Figure 4.
O2	To ensure adequate acoustic privacy for occupants and neighbours.	C2	The building is sited and designed to minimise the transmission of external noise to other buildings on the site and on adjacent land.
O3	To encourage building design, construction and use of materials that minimise conflicts between commercial and residential uses.	C3	The internal layout of rooms, courtyards, terraces and balconies, the use of openings, screens and blade walls, and choice of materials, is designed to

Objectives	Controls
	<p>minimise the transmission of noise externally.</p> <p>C4 The bedroom areas are separated, by way of barriers or distance, from on-site noise sources such as active recreation areas, car parks, vehicle access-ways and service equipment areas.</p> <p>C5 Noise impact associated with goods delivery and garbage collection, particularly early morning, is minimised.</p> <p>C6 For a restaurant or café, the design and operation minimises the impact of noise associated with late night operation on nearby residents.</p> <p>C7 A rear courtyard is only permitted for restaurant or café use if Council is satisfied that the use and hours of operation will not have an unreasonable impact on residential amenity.</p> <p>Note: Council may require a Noise Impact Assessment as part of the development application.</p>
<p>O4 To ensure adequate visual privacy for occupants and neighbours.</p>	<p>C8 Views to adjacent private open space are protected and screened consistent with Figure 5 below.</p> <p>C9 Visual privacy is protected by providing adequate distance between opposite windows of neighbouring dwellings where a direct view is not restricted by screening or planting.</p> <p>C10 Windows and balconies of upper level dwellings are designed to prevent overlooking of the private open space of any lower level dwellings directly below, and within, the same development.</p> <p>C11 Balconies are located and designed to provide privacy for occupants of the</p>

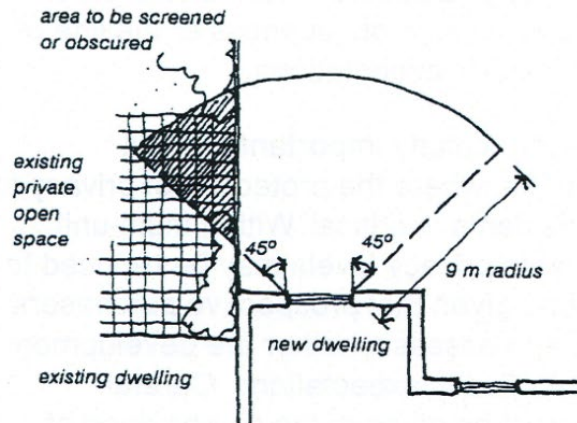
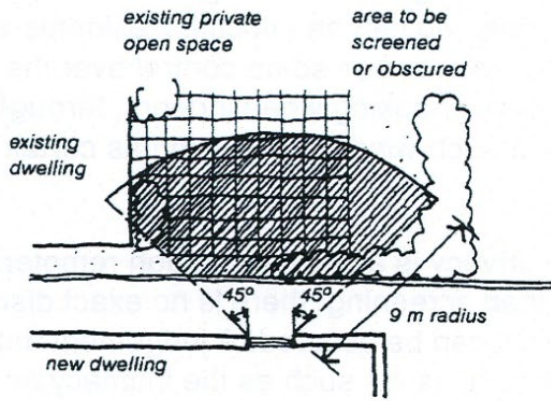
Objectives	Controls
	building when viewed from the street or nearby public space.

**FIGURE 4** Minimum distances for visual and acoustic privacy in mixed use centres

Source: AMCORD, 1995

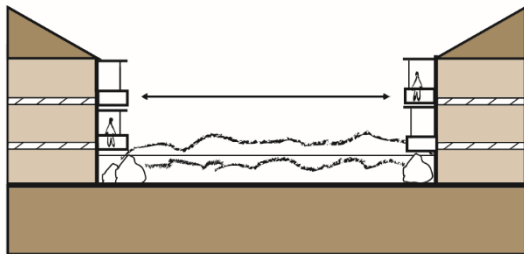


**FIGURE 5** Acceptable screening of views to adjacent open spaces



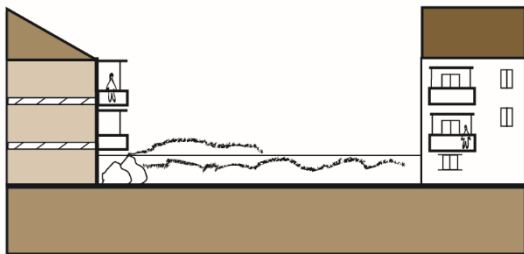
**FIGURE 6**

Ensure adequate separation between unscreened balconies. Privacy at ground floor level provided by suitable sill heights and planting



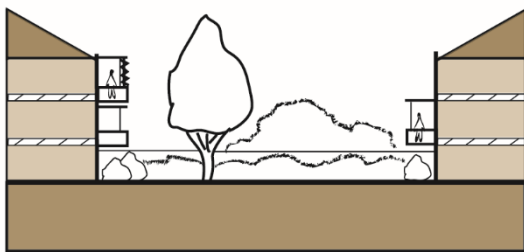
**FIGURE 7**

Careful location of balconies can increase privacy and reduce their separation



**FIGURE 8**

Vegetation and balcony screening can increase separation to ensure privacy



## D3.8 Landscaped area and private open space

Landscaped area in Woollahra LEP 2014 means “a part of a site used for growing plants, grasses and trees, but does not include any building, structure or hard paved area”. Deep soil landscaped area is the area of the site that contains landscaped area which has no above ground, ground level or subterranean development.

The landscaped area within developments may comprise both communal and private open space areas. Landscape treatment helps to determine the amenity of individual dwellings, define private and public areas, reinforce or screen views and define local character.

The amount and composition of landscaped area also play important roles in stormwater management, the energy efficiency of developments and access to sunlight.

Private open space is the area of land or of a building (such as a balcony or uncovered roof terrace) belonging to a dwelling and intended for the exclusive use of the occupants of the dwelling. It should be located and designed so as to offer visual privacy to the occupants.

Common open space is useable shared open space for the recreation and relaxation of residents of a development; the common space is generally under the control of a body corporate or equivalent.

The location and design of private and common open space should contribute to the amenity of the development.

Objectives		Controls	
O1	To enhance the appearance, amenity and energy efficiency of housing through landscaped area.	C1	Deep soil landscaped area comprises at least 10% of the site area, with the exception of Hopetoun Avenue, where at least 15% of the site area is deep soil landscaped area.
O2	To ensure the adequate provision of accessible and useable private and communal open space.	C2	Part of the private open space serves as an extension of the dwelling and is directly accessible from the main living area of the dwelling.
O3	To provide for the amenity of occupants.	C3	Communal open space is centrally located and easily accessed by all building occupants.
		C4	The minimum area of above ground private open space is determined by the dwelling size as outlined below: <ul style="list-style-type: none"> <li>a) small dwelling (less than 60m<sup>2</sup>)—8m<sup>2</sup>;</li> <li>b) medium dwelling (60m<sup>2</sup> to 80m<sup>2</sup>)—12m<sup>2</sup>; and</li> </ul>

Objectives		Controls	
			<p>c) large dwelling (more than 90m<sup>2</sup>)—16m<sup>2</sup>.</p> <p>C5 The preferred depth of the required above ground private open space is 2.4m. The minimum permissible depth is 1.8m.</p> <p>C6 Development provides at least one balcony, terrace, loggia, roof terrace, deck or the like for each dwelling, within the area nominated for building articulation area. This open space is accessible from a main living area.</p>
O4	To retain important existing mature trees, vegetation and other landscape features.	C7	Existing significant trees and vegetation are incorporated into the proposed landscaped area and treatment.
O5	To enhance stormwater management.	C8	<p>Wherever possible car parking is located under the building footprint to maximise deep soil landscaped area.</p> <p>Note: At grade car parking will only be considered where the applicant demonstrates that it is unreasonable to locate parking below ground and the minimum deep soil landscaped area is provided elsewhere on the site.</p>
O6	To increase opportunity for landscaped areas at ground level to improve amenity for building occupants and neighbours.		



## D3.9 Car parking and vehicular access

The neighbourhood centres and mixed use centres are generally located on or close to public bus transport routes. This helps limit car use and encourages other modes of transport, such as walking, cycling and public transport, helping to improve local amenity and minimise pollution and the use of non-renewable energy sources.

Council's car parking requirements aim to satisfy the parking demand likely to be generated by development, whilst recognising that opportunity for on-site parking is limited in many of the centres.

Parking areas, accessways and servicing facilities must be designed carefully so that they do not detract from the appearance of the development or the streetscape, and do not disrupt the continuity of the retail frontage or pedestrian movement.

In particular, vehicle access to a development site from the primary street is not permitted; this protects the continuous active retail frontages important for centres. Where there is no rear lane or side street access, this may restrict the potential for development that requires on-site parking or on-site loading facilities.

Where the parking involves excavation, Council will normally require geotechnical report prepared in accordance with the Council's *'Guide for preparing Geotechnical and Hydrogeological Reports'*. The preparation and submission of pre-commencement and post-completion dilapidation reports for properties adjoining and neighbouring the development will generally be applied as a standard condition of consent.

Objectives		Controls	
O1	To ensure that developments generating vehicular traffic make adequate provision for the off-street parking and servicing needs of its occupants and users, including visitors, employees and deliveries.	C1	Development complies with the provisions in Part E of the DCP, Chapter E1 Parking and Access.  Note: This includes parking generation rates for the commercial and residential components of development, design requirements and loading and servicing provisions.
O2	To ensure the safe and efficient movement of vehicles within, entering and leaving properties.		A parking concession may be granted for mixed use buildings when overlapping parking demand will occur for different uses or complementary use of spaces will occur for uses with different peak parking demand times.

Objectives		Controls	
O3	To maximise retail frontage to primary streets and provide for continuous retail street frontages.	C2	Access to on-site car parking and servicing facilities is provided from rear lanes or secondary streets.
O4	To ensure that on-site car parking and driveways do not dominate or detract from the appearance of the development and the local streetscape.	C3	Access to development is provided by one driveway only. The driveway is no wider than 6m wide.
		C4	On-site parking areas are provided below ground where possible, and car parking is not located on any level above the ground level.
		C5	On-site car parking areas are not visible from the main street frontage.
		C6	Facades screening car parks from the street are of high quality and allow natural lighting and ventilation.
		C7	Access to on-site car parking and servicing facilities is designed perpendicular to the street alignment and does not ramp along a street or lane alignments.  Note: In the case of small lots, consideration should be given to amalgamation of car parks and access and egress points.
O5	To maximise pedestrian and resident safety and amenity.	C8	Car parking and driveway areas are located and designed to: <ul style="list-style-type: none"> <li>a) minimise disruption to pedestrian movement, safety, and amenity;</li> <li>b) preserve existing trees and vegetation; and</li> <li>c) complement the desired future character for the precinct described in in Chapters D1 and D2.</li> </ul>
			C9

Objectives	Controls
	<p>C10 Residential parking areas are secure and separate from non-residential vehicle parking and servicing areas.</p>
<p>O6 To encourage the provision of walking and cycling facilities.</p>	<p>C11 A dedicated bicycle rack or area is provided in a convenient location at the rate of 1 bicycle space per 25 car spaces.</p>
<p>O7 To limit sub-surface excavation and impacts on adjoining properties and structures</p>	<p>C12 The area of site excavated for the purposes of underground car parking is limited to the building footprint of the development.</p> <p>C13 Excavation works are located on the lot subject to the development proposal only. Excavation does not occur under common walls, footings to common walls, or freestanding boundary walls, or under any other part of adjoining land with the exception of the amalgamation of parking areas for small lots.</p> <p>C14 Excavation for underground parking within 1.5m of adjacent boundaries is accompanied by a geotechnical report and a structural report to demonstrate that the works will not have any adverse effect on the neighbouring structures.  Note: Council may identify other circumstances where these reports are required. All reports must be prepared in accordance with Council's guidelines. Council may also require the preparation and submission of a pre-commencement dilapidation report for properties neighbouring the development.</p> <p>C15 Permanent sub-surface support and retention structures are set back a minimum of 900mm from adjacent property boundaries.</p>

Objectives		Controls	
O8	To minimise opportunities for surface water to flow to adjoining and adjacent properties.	C16	The ground floor levels of alterations and additions and infill development are consistent with the levels established by existing buildings and topography on adjoining site, where practical.
O9	To ensure the safe and efficient movement of vehicles within, entering and leaving properties.		Refer to Part E of the DCP, Chapter E1 Parking and Access.

## D3.10 Site facilities

Site facilities include those facilities or services that support and, or, maintain the operations of a building. All forms of development include site facilities. These include but are not limited to:

- ▶ On-site services including storage, garbage areas, mail boxes, clothes drying areas, vent stacks, and telecommunication infrastructure
- ▶ Mechanical plant rooms and equipment and other building services such as pump rooms, lift overruns, air-conditioning units and condensers, heating, mechanical ventilation systems, ventilation duct outlets, including any pipes and conduits
- ▶ Essential services and infrastructure such as electricity substations, fire hydrant and booster installations.

Some site facilities can be visually intrusive and have an adverse impact on the amenity of the streetscape and adjoining neighbours. It is important that the location, size and design of site facilities is considered and planned for during the design phase of any proposed development so the facilities can be thoughtfully integrated into the built form and landscaping, and potential impacts addressed.

Development applications are to be accompanied by dimensioned plans, drawn to scale, showing proposed locations and arrangements for site facilities including, where applicable:

- ▶ mechanical plant rooms and lift-overruns
- ▶ enclosures and/or cabinets for fire hydrants, booster valve assembly installations, sprinkler valves and associated hydraulic equipment
- ▶ an electricity substation.

The need to modify an existing consent to provide for a site facility should be avoided, and is an approach not supported by Council. Section 4.55 modification applications will need to demonstrate compliance with the DCP including requirements for setbacks, deep soil landscaped area, and tree retention etc. Council will not permit site facilities on public land.

Objectives		Controls	
O1	To ensure that adequate provision is made for essential site facilities.	C1	Lockable mail boxes are centrally located and integrated with the main building.
O2	To ensure that site facilities are functional and accessible to all premises within the development.	C2	Lockable storage space of at least 8m <sup>3</sup> per dwelling is provided.
O3	To ensure that site facilities are thoughtfully integrated into the development and are unobtrusive.	C3	Development incorporates adequate garbage and recycling collection areas that are integrated physically and visually with other built elements such as fences, walls, buildings and garages. Refer to Part E of the DCP, Chapter E5 Waste Management.

Objectives		Controls	
		C4	For a mixed use development, only one common television antennae is provided.
		C5	The design and location of aerials, antennae, and communications dishes: <ul style="list-style-type: none"> <li>a) do not have an unreasonable impact on the architectural character of the building to which it is attached;</li> <li>b) are not visually intrusive within the streetscape; and</li> <li>c) do not have an unreasonable impact on the amenity of adjoining and adjacent properties.</li> </ul>
O4	To protect the air quality and residential amenity.	C6	The building is designed to accommodate venting from ground floor uses, to avoid potential impacts from exhaust and odour, such as cooking smells.
O5	To facilitate the use of natural resources to dry clothes.	C7	Development that includes a residential component provides laundry facilities, and opportunity for the provision for at least one external clothes drying area.
O6	To ensure external clothes drying areas are suitably located.	C8	External clothes drying areas have access to sunlight, and are located in a secure place away from public spaces and screened from public view.  Note: External drying areas may be located in the landscaped areas.
O7	To ensure that mechanical plant equipment including lift overruns air-conditioning units and external condensers, do not have adverse streetscape or amenity impacts.	C9	Mechanical plant equipment (including lift overruns and air conditioners) must be located internally within the principal building in a suitably designed plant room or the like.
O8	To discourage the provision of mechanical plant equipment on the roofs of buildings to minimise visual impact of these services.	C10	Mechanical plant equipment (including lift overruns and air conditioners) must be wholly contained within the permissible building envelope and must not be located externally or on the roof unless Council is satisfied that it:
O9	To minimise visual and acoustic impacts on adjoining properties.		

Objectives	Controls
	<ul style="list-style-type: none"> <li>a) cannot be reasonably located elsewhere; and</li> <li>b) is thoughtfully located, sized, enclosed, concealed and integrated into the building design (including when viewed from above) and roof form so it:                             <ul style="list-style-type: none"> <li>i. is not visible from the streetscape or public domain;</li> <li>ii. is consistent with the overall building design, roof form and materials;</li> <li>iii. is visually discreet and unobtrusive when viewed from adjoining properties; and</li> <li>iv. minimises acoustic impacts to adjoining properties.</li> </ul> </li> </ul> <p>Note: Noise emissions from mechanical plant equipment must not exceed the background noise levels when measured at the boundary of the development site. The provisions of the <i>Protection of the Environment Operations Act 1997</i> apply.</p> <p>C11 Screening will only be considered where the screening is suitably located, integrated with the building design and materials and will have no impact on views or result in overshadowing of adjoining properties.</p> <p>Note: Screening alone may not be an acceptable solution for ensuring that mechanical plant equipment is not visible from the streetscape or the public domain.</p>
<p>O10 To ensure fire safety systems are accessible, functional and do not have a negative impact on the streetscape.</p>	<p>C12 Hydraulic fire services such as fire hydrants and booster installations are concealed. These services are to be:</p> <ul style="list-style-type: none"> <li>a) enclosed with doors if located in the building façade, or</li> <li>b) housed in a cabinet or enclosure if located external to the building.</li> </ul>

Objectives		Controls	
			The location, design, colour and material of the doors, cabinet or enclosure are to be visually unobtrusive and suitably integrated with the development, including any fencing and landscaping.
O11	To ensure that an electricity substation is not visible from the street, or any other adjoining public place.	C13	The substation is to be suitably located, screened and/or concealed. Council’s preference is for a chamber substation.
O12	To ensure that any screening or enclosure to conceal the substation does not detract from the streetscape character or design quality of the development.	C14	Any screening or enclosure to conceal the substation is to be visually unobtrusive and suitably integrated with the development, including the fencing and landscape design.
O13	To protect the amenity of adjoining residential dwellings from the impact of substations.	C15	The substation is to be located away from neighbouring properties or sufficiently screened from neighbouring properties.
O14	To ensure that vegetation does not interfere with the functioning of the substation.	C16	The location and design of the electricity substation must be considered and integrated with the landscaping of the proposed development, and must ensure that: <ul style="list-style-type: none"> <li>a) Vegetation does not overhang or encroach within the substation site.</li> <li>b) The substation is installed outside of the mature growth root zone of any trees to be retained, or proposed to planted, to prevent roots damage to underground cables.</li> </ul>
O15	To minimise the impact of other types of electricity infrastructure in the streetscape.	C17	The design and location of all other aboveground utility infrastructure (such as electrical pillars etc.) should minimise visual clutter within the streetscape and provide for a continuous accessible path of travel, where practical to ensure safe and equitable pedestrian circulation for people of all abilities. (Where this provision and Ausgrid’s requirements cannot both be satisfied, the applicant is to develop in consultation with Council and Ausgrid a solution that meets the acceptance of both consent authorities.)
Notes:			



---

Objectives	Controls
	<ul style="list-style-type: none"><li>• At the DA stage the applicant should demonstrate that they have engaged with Ausgrid and have a network capacity assessment undertaken for the proposed development.</li><li>• Where a substation is required, the substation should be identified on the DA plans and addressed in the <i>SEPP 65 Design Verification Statement</i> (also see Apartment Design Guide Objective 3C-2 Amenity of the public domain is retained and enhanced).</li><li>• The DCP requirements apply in addition to the Ausgrid Network Standards, such as <i>NS113 Site selection and construction design requirements for chamber substations</i>. Separate Ausgrid approval for the substation will be required.</li></ul>

# Chapter D4 Edgecliff Centre

Part D ▶ Business Centres


CHAPTER D4 APPROVED ON 27 APRIL 2015  
AND COMMENCED ON 23 MAY 2015

Last amended on 31 May 2024



---

# Chapter D4 ▶ Edgecliff Centre



<b>D4.1</b>	<b>INTRODUCTION .....</b>	<b>1</b>
	D4.1.1 Land where this chapter applies .....	1
	D4.1.2 Development to which this chapter applies.....	2
	D4.1.3 Objectives.....	2
	D4.1.5 How to use this chapter.....	3
<b>D4.2</b>	<b>EDGECLIFF CENTRE CONTROLS .....</b>	<b>4</b>
	D4.2.1 Precinct character statement .....	4
	D4.2.2 Desired future character .....	6
	D4.2.3 Objectives and controls.....	7



## D4.1 Introduction

This is Chapter D4 of the Woollahra Development Control Plan 2015 (DCP), Part D Business Centres.

This chapter contains controls for the Edgecliff Centre, zoned E1 Local Centre under the Woollahra Local Environmental Plan 2014 (LEP).

This chapter seeks to ensure that development has regard to its context and is compatible with the desired future character for the Edgecliff Centre as described in this chapter.

Oblique aerial of the Edgecliff Centre (bounded by New South Head Road, Ocean Street, New McLean Street and Arthur Street)



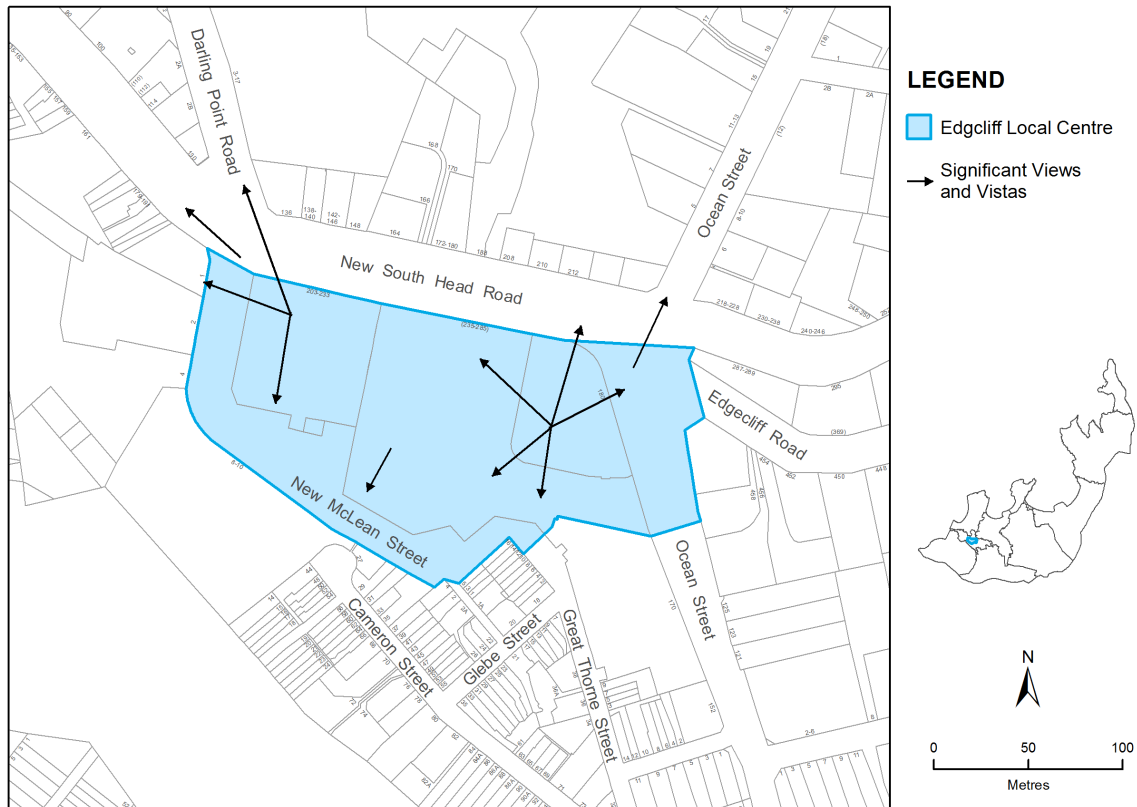
### D4.1.1 Land where this chapter applies

The Edgecliff Centre is located between New South Head Road to the north, New McLean Street and Arthur Street to the south and Ocean Street to the east, as identified in Map 1.

The centre comprises the following land:

- ▶ 203-233 New South Head Road (Lot 2 DP 553702, Lot 203 DP 1113922 and Lot 5 in DP 243380)
- ▶ 235-285 New South Head Road (Lot 61 DP 748554)
- ▶ 180 Ocean Street (SP 21608, SP 22762 and SP 30426).

## MAP 1 Edgecliff Centre



### D4.1.2 Development to which this chapter applies

This chapter applies to development that requires development consent.

Generally this will be mixed use retail, business, office and /or residential development, but may also include permitted uses such as child care centres, community facilities, and other uses as permitted by Woollahra LEP 2014.

### D4.1.3 Objectives

The objectives of this chapter are:

- 01 To encourage a high standard of architectural and landscape design in any new development within the centre.
- 02 To protect the amenity of residential and commercial development.
- 03 To protect the amenity of adjoining residential areas.
- 04 To improve connections within the centre and into the surrounding commercial and residential areas.

- 
- 05 To enhance the way development contributes to a sense of place.
  - 06 To encourage a diverse mix of uses in the centre, whilst maintaining its role of providing medical services.
  - 07 To activate the frontage to New McLean Street and Arthur Street.

#### D4.1.4 Relationship to other parts of the DCP

---

This chapter is to be read in conjunction with the other parts of the DCP that are relevant to the development proposal, including:

- ▶ Part E: General Controls for All Development - this part contains chapters on Parking and Access, Stormwater and Flood Risk Management, Tree Management, Contaminated Land, Waste Management, Sustainability, Signage and Adaptable Housing.
- ▶ Part F: Land Use Specific Controls - this part contains chapters on Child Care Centres, Educational Establishments, Licensed Premises and Telecommunications.

#### D4.1.5 How to use this chapter

---

The controls for the Edgecliff Centre comprise the following elements:

- ▶ map showing the extent of the centre;
- ▶ a precinct character statement, providing a brief description of the centre;
- ▶ desired future character, establishing the direction and outcomes required to be achieved through development in the centre; and
- ▶ a list of controls relating to uses, built form, building articulation and streetscape, and amenity. The controls represent specific ways in which a development proposal can meet the objectives.

Applicants need to demonstrate how their development fulfills the relevant objectives and preserves or enhances the important character elements for the precinct, having particular regard to:

- surrounding building height, bulk and scale
- any predominant architectural styles, roof forms, materials and colours
- prevailing building lines
- existing and proposed uses
- landscape and vegetation features
- topography
- view corridors
- pedestrian access and amenity
- interface between the private and public domain
- adjacent residential areas.



## D4.2 Edgecliff Centre controls

### D4.2.1 Precinct character statement

The Edgecliff Centre is part of the wider Edgecliff commercial area which includes the land zoned MU1 Mixed Use along New South Head Road. New South Head Road is a major State road linking the Eastern Suburbs to the city and is the primary route for vehicles to the Edgecliff Centre.

The Edgecliff Centre comprises three main sites: two contain a multi-storey retail and commercial buildings. The centre provides a good range of convenience retailing opportunities, including supermarkets and speciality stores and services the surrounding residential suburbs including, Edgecliff, Elizabeth Bay, Darlinghurst, Darling Point, Kings Cross, Paddington, Potts Point, and Woollahra. The centre also has a high proportion of medical services and experienced a 40% increase in health care related jobs from 2006 to 2011.

The Edgecliff Bus and Rail Interchange also form part of the centre. Local and regional bus routes service the bus interchange which is located above the Eastpoint Shopping Centre.

#### Edgecliff bus and rail interchange and the Edgecliff Centre building



The Edgecliff Centre building

---

### Historical development and transport

Early photographs from the 1860s reveal clusters of dwellings and business along the southern side of New South Head Road. During that era, there was a toll for using New South Head Road.

In September 1894 a cable tram service opened operating from King Street in the city to Ocean Street in Edgecliff.

In the 1960s, the shop top houses on the southern side of New South Head Road were demolished to make way for Edgecliff Station. Edgecliff railway station and bus interchange opened in 1979, when the Illawarra line was extended from Town Hall railway station to Bondi Junction.

### Built form

The built form consists of:

- ▶ a building called the Edgecliff Centre—a seven storey building over one level of car parking, located at the western end of the centre, containing retail, business and office uses;
- ▶ the Eastpoint Shopping Centre—a three storey building containing retail and business uses and a car park. The railway station and bus interchange are also accessed from this building; and
- ▶ Eastpoint Tower—a 2 to 14 storey mixed use residential and commercial building on Ocean Street, located at the eastern end of the centre.

The centre primarily addresses New South Head Road. On New McLean Street, car park entries and loading bays dominate the streetscape, and the landscaping is sparse and uncoordinated. This creates an unwelcoming pedestrian environment with little visual interest and provides a harsh transition to the residential land opposite.

Connectivity across the centre is restricted as the Eastpoint Shopping Centre and Edgecliff Centre car parks are separate despite being located next to each other. This also unnecessarily increases the number of vehicle crossings on the New McLean Street frontage.

### Heritage and contributory buildings

There are no heritage items or contributory buildings in the Edgecliff Centre.

### Public parks

There are no public parks in the Edgecliff Centre. However, Edgecliff Square is located on the eastern side of Ocean Street and Trumper Park is 100m to the south.

### Views and vistas

Due to its position on top of a hill, there are significant views from existing buildings to Port Jackson in the north, Sydney CBD to the west and generally within the region. From street level views of the local region, CBD and Harbour Bridge are possible. The key views and vistas are identified in Map 1 above.

From the residential tower and commercial offices at either end of the centre, iconic views are possible, such as to the Opera House and Harbour Bridge.

---

---

## D4.2.2 Desired future character

---

The Edgecliff Centre will reinforce its role as the focus of retail and business activity and continue to be convenient place for people to meet, work, shop and use services.

The built form will promote an urban environment which meets high standards of visual quality and pedestrian amenity.

Buildings will be up to eight storeys on New South Head Road and transition down to one to two storeys at New McLean Street frontage. At the corner of Ocean Street and New South Head Road buildings up to 10 storeys are permitted.

New McLean Street will have an active street frontage and parking and servicing arrangements will be reconfigured to be less visually intrusive. The amenity will be improved by including streetscape works, landscaping and reducing the frontage dedicated to vehicle movements.

Pedestrian links across the centre, and through the centre to the bus interchange and railway station, will be enhanced. The connections to the surrounding New South Road commercial corridor and nearby residential land will increase pedestrian activity and convenience. Where commercial development addresses a street, awnings will be provided at street level for weather protection.

Given the excellent public transport access, the centre is ideally located for increased residential and commercial land uses. Retailing, medical and health related services and professional services will continue to cater for the needs of the local community.

### D4.2.3 Objectives and controls

Objectives		Controls	
O1	To promote an attractive street wall.	C1	The ground floor of the building on New South Head Road is setback 3m.
O2	To ensure building articulation makes a significant contribution to the design of buildings.	C2	The building at 203-233 New South Head Road addresses New McLean Street, is related to the scale of pedestrians and provides visual interest. This may be achieved by:
O3	To improve the relationship of buildings to the public domain.		a) providing an active frontage to New McLean Street;
O4	To ensure that development enhances the visual quality and identity of the centre through well considered design, high quality materials and facade colours that do not dominate the street.		b) reconfiguring the parking and servicing arrangements so these do not dominate the streetscape; and
			c) reducing the number and width of vehicle cross overs.
		C3	The design of the lower part of the street facade relates to the scale of pedestrians.
		C4	Facades are richly articulated and express the different levels of the building and/or its functions.
		C5	Facade design incorporates similar proportions of glazed and non-glazed surfaces and achieves a balance between vertical and horizontal divisions. The extensive use of glass is avoided.
		C6	Facade elements are generally contained in vertical planes aligned with the street. Sloping facades are avoided.
		C7	Where visible from the public domain, party walls include articulation. Blank party walls are avoided.
		C8	Large expanses of highly reflective, brightly coloured surfaces or black shading are not used on facades.
		C9	New buildings and facades do not result in glare that causes discomfort or

Objectives		Controls	
			<p>threatens safety of pedestrians or drivers.</p> <p>Note: A reflectivity report analysing potential glare from the proposed new development on pedestrians or motorists may be required to be submitted with the DA.</p>
05	To ensure that the colour of the building facade is not intrusive or unreasonably dominant within the streetscape, and is compatible with the desired future character of the centre.	C10	The external painting of a building in bright colours, corporate colours or fluorescent colours is avoided.
		C11	Any individual business branding and identity in external painting and colour schemes is subordinate to the main colour schemes in the street.
			Note: Also refer to the signage controls in Part E7 of the DCP, Section 7.2.2 When external painting of a building constitutes a wall sign.
06	To improve pedestrian access between the commercial buildings in the centre.	C12	The permeability and connectivity of the centre is improved. For example, by providing north-south thoroughfares and improving links between the retailing spaces and the public transport facilities.
		C13	Access to public car parking areas from the different buildings in the centre is integrated to improve connectivity.
07	To require the provision of public art in significant or large-scale developments.	C14	Development with a capital investment value of \$15M or more includes public art.
08	To integrate the public art so it is a cohesive part of the building design, interior or landscaping of the development.	C15	The public art is installed on the development site or in the immediate vicinity of the site.
09	To design and locate the public art so that the aesthetics and amenity of the art can be appreciated by people within and outside the development.	C16	The public art is located so that it is not unreasonably inaccessible or obscured by a building element which makes it impossible to see in full by the building occupants and the general public.

Objectives	Controls
<p>O10 To enhance the experience of the occupants of the development and their relationship with the development through public art.</p> <p>O11 To use public art to facilitate a connectedness between the development and the public domain.</p>	<p>C17 The public art is prepared and undertaken in accordance with the Woollahra Public Art Guidelines for Developers.</p>
<p>O12 To provide an attractive and comfortable pedestrian environment.</p>	<p>C18 Development provides an active frontage to New South Head Road, New McLean Street and Arthur Street.</p> <p>C19 Development provides a continuous awning to New South Head Road and New McLean Street.</p> <p>C20 Awnings are designed and constructed to:</p> <ul style="list-style-type: none"> <li>a) provide continuity and complement the facade and adjoining awnings;</li> <li>b) follow the street grade; and</li> <li>c) be of sufficient depth to provide good shade and shelter to pedestrians.</li> </ul> <p>C21 Where under awning lighting is included, the lighting is either recessed into the soffit of the awning or wall mounted on the building.</p> <p>C22 Public domain improvements, including street tree planting and pavement upgrading, are consistent and unify the centre and improve pedestrian amenity.</p>
<p>O13 To ensure that signage and structures do not compromise the visual amenity of the streetscape.</p>	<p>Refer to Part E of the DCP, Chapter E7 Signage.</p> <p>Note: Advertising signage is not permitted.</p>
<p>O14 To ensure that mixed use developments are designed to minimise conflict between different uses on the site.</p>	<p>Note: <i>State Environmental Planning Policy No. 65 - Design Quality of Residential Flat Development (SEPP 65)</i> is a mandatory consideration for all applications for a</p>

Objectives	Controls
<p>O15 To ensure that building design and layout provides quality residential living environments.</p>	<p>residential flat building that is three or more storeys and contains four or more self-contained dwellings. This includes mixed use development with a residential component.</p> <p>C23 The internal layout of rooms, courtyards, terraces and balconies, the use of openings, screens and blade walls, and choice of materials, is designed to minimise the transmission of noise externally.</p> <p>C24 Visual privacy is protected by providing adequate distance between opposite windows of neighbouring dwellings where direct view is not restricted by screening or planting.</p>
<p>O16 Ensure adequate provision of site facilities.</p> <p>O17 Ensure site facilities are accessible, functional and unobtrusive.</p> <p>O18 To protect the amenity of adjoining residential zoned land.</p> <p>O19 Minimise overshadowing of adjoining properties and Cooper Park Oval.</p>	<p>C25 Site facilities are suitably integrated with the development and its landscaping to minimise visibility from the street.</p> <p>C26 Hydraulic fire services such as fire hydrants and booster installations are concealed. These services are to be:</p> <ul style="list-style-type: none"> <li>a) enclosed with doors if located in the building façade, or</li> <li>b) housed in a cabinet or enclosure if located external to the building.</li> </ul> <p>The location, design, colour and material of the doors, cabinet or enclosure are visually unobtrusive and suitably integrated with the development, including any fencing and landscaping.</p> <p>C27 The building design minimises overlooking into the habitable rooms and open space areas of adjoining residential uses.</p> <p>C28 Development maintains solar access to existing adjoining dwellings for a period of two hours between 9am and 3pm on 21 June to existing north facing windows</p>

Objectives	Controls
	<p>of habitable rooms, and for at least two hours to at least 50% of the private open space. Where existing overshadowing is greater than this, sunlight is not to be further reduced.</p> <p>C29 Solar access to the Trumper Park Oval is provided between the hours of 10am and 2pm on 21 June. Where existing overshadowing is greater than this, sunlight is not to be further reduced.</p>
<p>O20 To ensure that an electricity substation is not visible from the street, or any other adjoining public place.</p> <p>O21 To ensure that any screening or enclosure to conceal the substation does not detract from the streetscape character or design quality of the development.</p>	<p>C30 The substation is to be suitably located, screened and/or concealed. Council’s preference is for a chamber substation.</p> <p>C31 Any screening or enclosure to conceal the substation is to be visually unobtrusive and suitably integrated with the development, including the fencing and landscape design.</p>
<p>O22 To protect the amenity of adjoining residential dwellings from the impact of substations.</p>	<p>C32 The substation is to be located away from neighbouring properties or sufficiently screened from neighbouring properties.</p>
<p>O23 To ensure that vegetation does not interfere with the functioning of the substation.</p>	<p>C33 The location and design of the electricity substation must be considered and integrated with the landscaping of the proposed development, and must ensure that:</p> <ul style="list-style-type: none"> <li>a) Vegetation does not overhang or encroach within the substation site.</li> <li>b) The substation is installed outside of the mature growth root zone of any trees to be retained, or proposed to be planted, to prevent roots damage to underground cables.</li> </ul>



Objectives	Controls
<p>O24 To minimise the impact of other types of electricity infrastructure in the streetscape.</p>	<p>C34 The design and location of all other aboveground utility infrastructure (such as electrical pillars etc.) should minimise visual clutter within the streetscape and provide for a continuous accessible path of travel, where practical to ensure safe and equitable pedestrian circulation for people of all abilities. (Where this provision and Ausgrid’s requirements cannot both be satisfied, the applicant is to develop in consultation with Council and Ausgrid a solution that meets the acceptance of both consent authorities.</p>
<p>Notes:</p> <ul style="list-style-type: none"> <li>• At the DA stage the applicant should demonstrate that they have engaged with Ausgrid and have a network capacity assessment undertaken for the proposed development.</li> <li>• Where a substation is required, the substation should be identified on the DA plans and addressed in the <i>SEPP 65 Design Verification Statement</i> (also see Apartment Design Guide Objective 3C-2 Amenity of the public domain is retained and enhanced).</li> <li>• The DCP requirements apply in addition to the Ausgrid Network Standards, such as <i>NS113 Site selection and construction design requirements for chamber substations</i>. Separate Ausgrid approval for the substation will be required.</li> <li>• A dedicated access way/easement through the site to the substation will also need to be provided in accordance with the requirements of Ausgrid and Council.</li> </ul>	

# Chapter D5 Double Bay Centre

Part D ▶ Business Centres

CHAPTER D5 APPROVED ON 27 APRIL 2015  
AND COMMENCED ON 23 MAY 2015

Last amended on 8 December 2023



# Chapter D5 ► Double Bay Centre

## Contents

<b>D5.1</b>	<b>INTRODUCTION .....</b>	<b>1</b>
	D5.1.1 Land where this chapter applies .....	1
	D5.1.2 Development to which this chapter applies.....	2
	D5.1.3 Objectives.....	2
	D5.1.4 Relationship to other parts of the DCP.....	3
	D5.1.5 How to use this chapter.....	3
<b>D5.2</b>	<b>UNDERSTANDING THE CONTEXT .....</b>	<b>6</b>
	D5.2.1 Siting .....	6
	D5.2.2 Historical development .....	6
	D5.2.3 Built form.....	7
	D5.2.4 Public parks and facilities .....	7
	D5.2.5 Access and circulation .....	8
	D5.2.6 Building uses .....	8
<b>D5.3</b>	<b>URBAN STRUCTURE .....</b>	<b>9</b>
	D5.3.1 Structure of the Double Bay Centre .....	9
	D5.3.2 Key strategies for the Double Bay Centre .....	11
<b>D5.4</b>	<b>STREET CHARACTER .....</b>	<b>15</b>
	D5.4.1 Desired future character .....	15
	D5.4.2 Common street strategies .....	15
	D5.4.3 New South Head Road.....	15
	D5.4.4 Bay Street (south).....	17
	D5.4.5 Bay Street (centre) .....	20
	D5.4.6 Knox Street.....	21
	D5.4.7 Cross Street .....	22
	D5.4.8 The Lanes.....	24
	D5.4.9 Knox Lane .....	24
	D5.4.10 Short Street.....	26
	D5.4.11 Gumtree Lane .....	27
	D5.4.12 Goldman Lane.....	28
	D5.4.13 Kiaora Lane .....	29
<b>D5.5</b>	<b>BUILT FORM ENVELOPES: CONTROL DRAWINGS .....</b>	<b>31</b>
	D5.5.1 Urban form methodology .....	31
	D5.5.2 Explanatory legend .....	33
	D5.5.3 Double Bay Centre built form envelopes, ground and first floors (levels 1 and 2).....	34
	D5.5.4 Double Bay Centre built form envelopes (levels 3 and above).....	35
	<b>D5.5.5 Control drawing 1 Control summary .....</b>	<b>37</b>
	<b>D5.5.6 Control drawing 2 Control summary .....</b>	<b>39</b>
	<b>D5.5.7 Control drawing 3 Control summary .....</b>	<b>41</b>
	<b>D5.5.8 Control drawing 4 Control summary .....</b>	<b>43</b>
	<b>D5.5.9 Control drawing 5 Control summary.....</b>	<b>45</b>

---

D5.5.10 Control drawing 6	<b>Control summary</b>	47
D5.5.11 Control drawing 7	<b>Control summary</b>	49
D5.5.12 View 1: 3D view of building envelopes		51
D5.5.13 View 2: 3D view of building envelopes		53
<b>D5.6</b>	<b>DEVELOPMENT CONTROLS</b>	<b>55</b>
D5.6.1	Format	55
D5.6.2	Use	56
D5.6.3	Urban character	58
D5.6.4	Relationship to public domain	73
D5.6.5	Amenity	82
D5.6.6	Solar access and natural ventilation	89
D5.6.7	Geotechnology and hydrogeology	92
D5.6.8	Parking and site facilities	93
D5.6.9	Application of concessions	98
<b>APPENDIX 1:</b>	<b>TRANVAAL AVENUE HERITAGE CONSERVATION AREA</b>	<b>99</b>
A1.1	Introduction	99
A1.2	Historical outline	99
A1.3	Character and description	99
A1.4	Summary statement of significance	100
A1.5	Management policy	101
<b>APPENDIX 2:</b>	<b>KIAORA LANDS</b>	<b>104</b>
A2.1	Background	104
A2.2	Objectives	105
A2.3	Development framework	106
A2.4	Built form envelopes	113
A2.5	Development controls	118

---

## D5.1 Introduction

This is Chapter D5 of the Woollahra Development Control Plan 2015 (DCP), Part D Business Centres. It establishes detailed controls to guide future development in the Double Bay Centre.

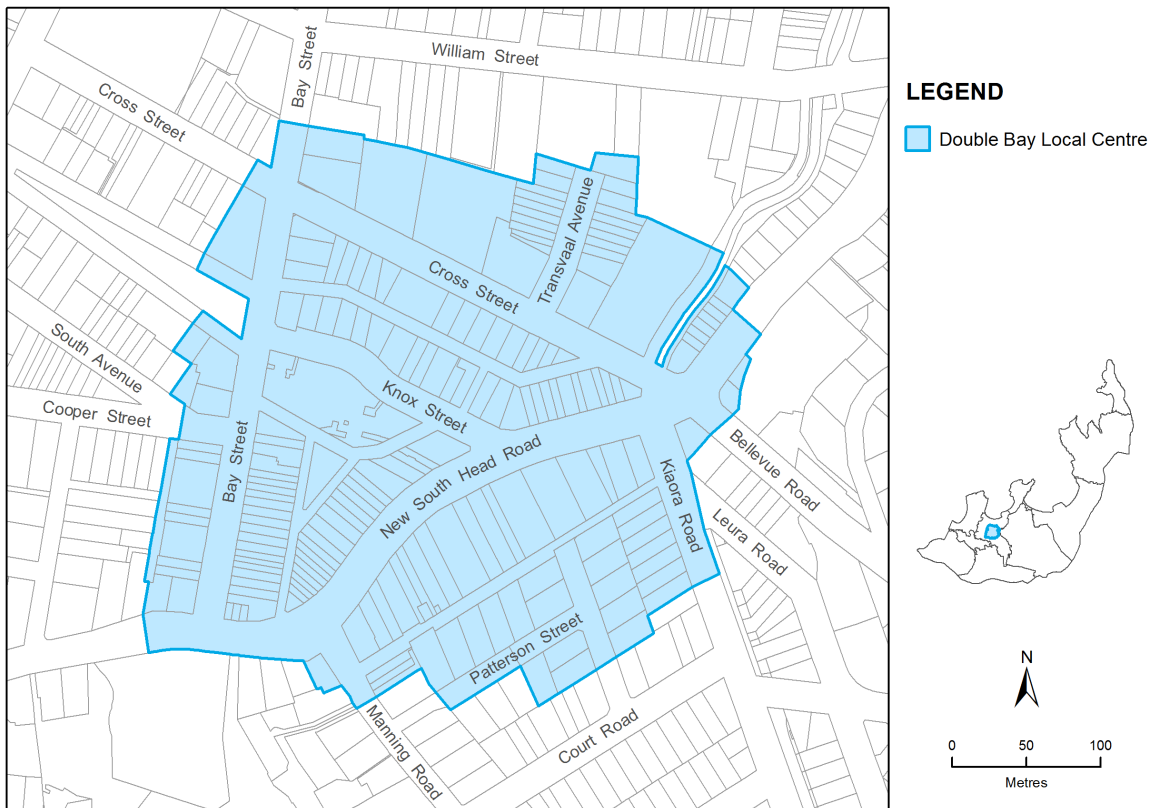
Double Bay is a unique local centre, which enjoys a privileged position near the southern edge of Sydney Harbour at the base of a large natural amphitheatre.

Its accessibility and distinctive landscape quality evoke an appealing cosmopolitan character that is warmly valued by local residents and users of the centre.

### D5.1.1 Land where this chapter applies

This chapter applies to the Double Bay Centre, as identified in Figure 1.

**FIGURE 2** Location plan



---

### D5.1.2 Development to which this chapter applies

---

This chapter applies to development that requires development consent.

Generally this will be mixed use retail, business, office and /or residential development, but may also include permitted uses such as child care centres, community facilities, and other uses as permitted by Woollahra LEP 2014.

Development should contribute to a vibrant centre that offers a unique living, working and shopping experience within a pedestrian friendly and attractive urban environment.

**FIGURE 2** View along Bay Street towards New South Head Road indicating possible future development



---

### D5.1.3 Objectives

---

The objectives of this chapter are:

- 01 To retain and enhance through block connections which allow pedestrians to move freely within the Double Bay Centre.
- 02 To develop the particular qualities of different parts of the Double Bay Centre.
- 03 To encourage a diverse mix of uses in the Double Bay Centre and maintain retail uses at ground level.
- 04 To conserve and enhance the visual and environmental amenity of all buildings and places of heritage significance in the Double Bay Centre.
- 05 To enhance the way development contributes to a sense of place.
- 06 To ensure a high standard of architectural and landscape design in any new developments within the Double Bay Centre.
- 07 To preserve and enhance the diversity of uses in the Double Bay Centre.
- 08 To ensure that new development is compatible with the existing built form, and streetscape and village character.
- 09 To encourage view sharing and individual privacy.

- 
- O10 To ensure new development is designed to be compatible with the heritage significance of listed heritage items.

### D5.1.4 Relationship to other parts of the DCP

---

This chapter is to be read in conjunction with the other parts of the DCP that are relevant to the development proposal, including:

- ▶ Part E: General Controls for All Development - this part contains chapters on Parking and Access, Stormwater and Flood Risk Management, Tree Management, Contaminated Land, Waste Management, Sustainability, Signage and Adaptable Housing.
- ▶ Part F: Land Use Specific Controls - this part contains chapters on Child Care Centres, Educational Establishments, Licensed Premises and Telecommunications.

### D5.1.5 How to use this chapter

---

Applicants seeking to redevelop or alter sites within the Double Bay Centre must carefully consider the context of their proposal and identify the Built Form Envelopes, Control Drawings and Development Controls in this chapter which apply.

Compliance with the provisions of this chapter does not guarantee that consent to a development application will be granted. Each development application will be assessed having regard to Woollahra LEP 2014, this DCP, other matters listed in section 79C of the *Environmental Planning and Assessment Act 1979* and any other policies adopted by the Council.

The Double Bay Public Domain Improvements Plan (1999) should also be used as a guide to works in the public domain, and includes details of street tree planting, footpaths, street furniture, and vehicular and pedestrian crossings.

This chapter of the DCP is structured as follows:

#### D5.1 Introduction

General information about the Double Bay Centre chapter of the DCP, including why it was prepared, its objectives and its relationship to other planning documents.

#### D5.2 Understanding the context

Provides a summary description of the existing urban context. The Double Bay Centre Urban Design Study, on which this chapter was based, provides a more detailed description and analysis of the existing urban context.

#### D5.3 Urban structure

Provides an understanding of the current urban structure of the Double Bay Centre. Objectives for the future character, form and function of the Double Bay Centre are also described.

---



---

## D5.4 Street character

Describes the desired future character of the streets in the Double Bay Centre.

### Using the built form controls

The development controls are derived from the Double Bay Centre Urban Design Study. They respond to the strategies set out in Section 5.3.2 of this chapter and the desired future character described in Section 5.4.1.

Controls have been designed for each individual site in the Double Bay Centre to optimise development, whilst taking into consideration the potential of adjoining properties and public spaces. The adopted Urban Form Methodology (Section 5.5.1) provides a greater certainty of outcome for Council, community and site owners.

Built form controls in the Double Bay Centre are expressed in graphic form as built form envelopes on the control drawings and in written and illustrated form as development controls.

## D5.5 Built form envelopes: Control drawings

The controls are in the form of building envelopes, which set the position of development on each site. There are two control drawings for every site in the Double Bay Centre; one showing the ground and first floor levels and the other showing all levels above.

The control drawings are accompanied by a descriptive legend, and further explanation is provided in Section D5.6. Three dimensional images of the building envelopes assist in the interpretation of the development controls.

## D5.6 Development controls

These explain in written and illustrated form the following areas of building development:

- ▶ **Use** which refers to building use such as retail, commercial and residential.
- ▶ **Urban character** which includes building envelopes, setbacks, heritage, architectural resolution, roof design, awnings, privacy, signage and advertising, and outdoor eating.
- ▶ **Relationship to public domain** which includes awnings, colonnades, arcades, public art, outdoor eating and ground floor frontage to lanes.
- ▶ **Amenity** which includes landscaped areas, above ground open spaces such as balconies and roof terraces.
- ▶ **Solar access and natural ventilation** which addresses these two matters.
- ▶ **Geotechnology and hydrogeology** which addresses geotechnical and hydrogeological impacts on any surrounding property and infrastructure as a result of development.
- ▶ **Parking and servicing** which includes pedestrian access and mobility, on-site parking, vehicular access, and site facilities.

There is an additional section that deals with the application of concessions for cultural facilities and for corner lots.

---

### **Appendix 1: Transvaal Avenue Heritage Conservation Area**

Controls relating to development in the Transvaal Avenue Heritage Conservation Area.

### **Appendix 2: Kiaora Lands**

Controls relating to development in the Kiaora Lands site.

The provisions of Appendix 2 prevail over the diagrams, figures, controls and other provisions in Sections D5.3 to D5.5 that relate to Kiaora Lands unless otherwise specified.

## D5.2 Understanding the context

### D5.2.1 Siting

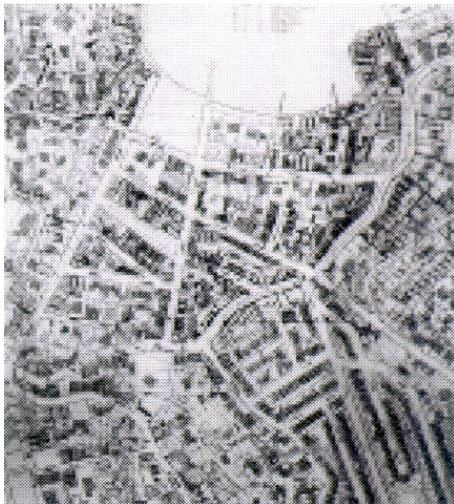
The Double Bay Centre is located in Sydney's Eastern Suburbs, in a large natural amphitheatre close to, but visually separated from the harbour foreshore. It sits at the base of a valley, cradled between the two ridges of Darling Point/Edgecliff and Bellevue Hill.

The principal entry into Double Bay is New South Head Road which traverses the centre. Other street connections include Ocean Avenue, Bellevue, Kiaora and Manning Roads and Greenoaks Avenue. New South Head Road is characterised by its unique street geometry, views to extensive landscape elements beyond, and a sense of spatial containment from the street edge building and surrounding landscape.

### D5.2.2 Historical development

The settlement of Double Bay was established in 1834 by the creation of five streets between Ocean Avenue and Bay Street, forming the blocks containing 50 generously sized allotments. The catalyst for the establishment of the Double Bay village was the opening of New South Head Road as a private tollway.

**FIGURE 3** Historical plan circa 1950



The development of Double Bay intensified and shifted toward New South Head Road around the time of the tramline extension past Edgecliff in 1898. This shift is revealed by the extension of Cross Street east to connect to New South Head Road, the creation of Short Street, and the tightly knit terrace house subdivision on the corner of Bay Street and New South Head Road.

Development between the wars concentrated along the New South Head Road corridor. During the 1960s and 1970s, the commercial area expanded into the adjoining predominantly residential areas of Bay, Cross, Knox and Patterson Streets.

---

Woollahra LEP 2014 identifies heritage listed properties in the centre, such as the Inter-War Golden Sheaf Hotel. An archaeological site containing sewerage infrastructure is located underground at the corner of Cross Street and New South Head Road. A heritage conservation area in Transvaal Avenue comprises single storey semi-detached cottages, and is a remnant of the centre's former housing stock.

### D5.2.3 Built form

---

The building stock in and around the centre reveals a cross section of architecture of varying quality. The built form of the centre reflects a mix of periods, building types and scale with no particular period predominating. The architectural and streetscape quality is generally undistinguished, with a few exceptions.

The buildings between New South Head Road, Bay and Short Streets have retained the fine grain evident in the early subdivision pattern. The allotments and buildings between Knox Street and Cross Streets are generally wider and shallower, but are coherent as a group in terms of grain, scale and massing. These buildings are honeycombed with arcades that allow a variety of pedestrian connections between the two streets.

The amalgamation and redevelopment of some sites along the north side of Cross Street have created buildings of different height and bulk to the predominant building stock. Some site amalgamation and redevelopment has also occurred along Bay Street and south of New South Head Road. The recent Kiaora Lands development contains a three storey retail building and car park with over 440 spaces.

### D5.2.4 Public parks and facilities

---

The centre has one small park as a median in the centre of Guilfoyle Avenue. Two other parks adjoin the centre. Foster Park includes a baby health centre Woollahra Preschool and the Local History Centre, with a park which is heavily compromised by its steepness. Steyne Park on the harbour is very well used and its facilities include two playing fields, a playground and Double Bay's only public toilet. It is also regularly used by the school children attending Double Bay Public School across William Street.

The minor community buildings include the small church hall at the corner of Transvaal Avenue and Cross Street, in the centre and the synagogue nearby in Kiaora Road.

Community facilities within the centre are the three storey public library which is part of a retail arcade that opens onto and a landscaped public plaza at Kiaora Lands, and the Studio 1 meeting room which is part of the Cross Street car park site.

---

### D5.2.5 Access and circulation

---

The centre has limited street connections to the surrounding area along New South Head Road, Manning Road, Kiaora Road and Bellevue Road. The scarcity of connections arises from topographical constraints and very large block sizes that limit pedestrian accessibility and concentrates traffic into a few access points.

Vehicular traffic in the centre operates reasonably effectively, despite relatively few access points and the presence of through traffic. Parking is concentrated in council car parks on Cross Street and Kiaora Road. On-street parking is heavily used throughout the centre and adjoining areas.

The Double Bay Centre is serviced by a number of bus routes. Edgecliff Railway Station and the ferry wharf at the end of Bay Street provide further public transport links to the city centre and other parts of Woollahra.

The centre has an attractive ambience for pedestrians due to the generally continuous shop fronts along streets and through block arcades on shallow lots.

The harbour is accessible across Steyne Park and from Beach Street, Bay Street and Ocean Avenue. Extending streetscape improvements down to the ferry wharf will strengthen the connection of Bay Street to the waterfront.

### D5.2.6 Building uses

---

The Double Bay Centre contains a mix of retail, commercial, service and residential uses. The retail activity is concentrated between Knox and Cross Streets, and along New South Head Road, Bay Street and Cross Streets.

High quality small scale speciality retailing defines the image and character of the Double Bay Centre. And in late 2014 the InterContinental Hotel opened on the former site of the Ritz Carlton Hotel after a significant renovation of the existing building.

The provision of more local services such as the Double Bay Library, which is part of the Kiaora Lands development, will benefit residents in and near the centre.

**D5.3 Urban structure**

**D5.3.1 Structure of the Double Bay Centre**

These maps provide an understanding of the current urban structure of the Double Bay Centre including key elements and features in the centre.

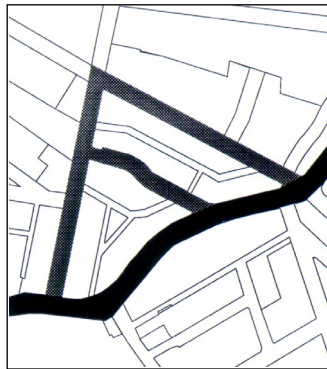
**FIGURE 4**  
**Urban structure**

The extent of the Double Bay Centre showing significant places and the axis of New South Head Road.



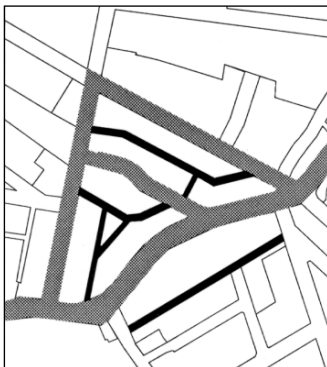
**FIGURE 5**  
**Layout - major streets**

Four or five storey buildings built to the street boundary are encouraged along the major streets to provide spatial definition.



**FIGURE 6**  
**Layout - lanes**

The lanes are considerably narrower than the streets. Generally, two storey buildings are encouraged to spatially define lanes. Lanes provide discrete service access necessary for retail centres.



**FIGURE 7**  
**Layout - pedestrian connections**

The pedestrian connections shown in this diagram indicate their most desirable locations. They supplement the existing layout of streets and lanes, increasing their accessibility. Through block connections are encouraged in most locations but not on corner sites.



**FIGURE 8****Layout - pedestrian axis**

This plan recognises the importance of the structure of public places from Guilfoyle Park along Knox Street to New South Head Road. Extending this pedestrian axis to the new library and square on Kiaora Lane should be encouraged to strengthen the connection between places on each side of New South Head Road.

**FIGURE 10****Built form - building to the street boundary**

Buildings built to the street boundary spatially define the street. Building controls in this plan respond to street width and orientation, and adopt a consistent rationale relating to:

- street alignment
- building lines
- building height
- building articulation depth.

**FIGURE 9****Subdivision layout - small lots**

This plan encourages the continuity of the fine building grain of Double Bay by applying a rationale of controls for lots that are less than 6m wide and/or less than 30m deep which differ from controls for other lots

**FIGURE 11****Built form - prominent corners**

The unusual street geometry creates prominent corner sites and significant urban spaces. This plan recognises the importance of these places and encourages well designated buildings built to the street boundary which contribute to their spatial definition.



---

Note: Figure 4 (*Urban structure*), Figure 6 (*Layout - lanes*), Figure 8 (*Layout - pedestrian axis*) and Figure 10 (*Built form -building to the street boundary*) do not apply directly to Kiaora Lands. Refer to Appendix 2 for the relevant provisions for Kiaora Lands.

### D5.3.2 Key strategies for the Double Bay Centre

---

Our vision for Double Bay is as a vibrant centre that offers a unique living, working and shopping experience within a pedestrian friendly and attractive built environment.

The intention of this chapter is to strengthen and enrich the existing urban structure of Double Bay and to create a memorable character for the Double Bay Centre by incorporating the following:

#### Enhance and improve the public domain and the provision of public facilities

- a) Enhance the public domain of Double Bay by applying a coordinated approach to the public domain and streetscape.
- b) Encourage multiple uses of Council car park sites such as providing community services and facilities at the ground floor and/or street façade and/or the roof terrace of Council's car park properties.
- c) Promote the important role that public transport plays in Double Bay.

#### Ensure that the centre maintains its commercial viability and competitive position within the Sydney retail market

- a) Foster the existing mix of uses of the centre such as hotels, retail and commercial and upper level residential.
- b) Encourage a flexible built form that can potentially support a diverse mix of uses in the centre.
- c) Consolidate the retail centre and intensify its usage by encouraging active retail frontage to laneways and establishing transition areas on the edge of the centre to mediate between the centre and residential areas beyond.
- d) Enhance the image of Double Bay as a premier boutique and designer fashion store destination.
- e) Encourage increased food and service retail uses.



---

### Develop the particular qualities of different parts of the centre

- a) Encourage redevelopment of Double Bay's address to New South Head Road by:
  - intensifying the urban scale and vitality of New South Head Road;
  - encouraging development that responds to and continues to describe the strong curved form of New South Head Road through the centre; and
  - retaining the views to large areas of vegetation existing at each end of the centre, beyond Bellevue Road to the east and Manning Road to the west.
- b) Retain and enhance the sunlit block of arcades between Knox Street and Cross Street.
- c) Spatially define the distinctive street geometry of Knox Street.
- d) Reinforce the Bay Street promenade and vista to the harbour foreshore.
- e) Retain the scale of small lot development and street character of Bay Street south of Short Street.
- f) Reinforce the urban space at the end of Guilfoyle Park, using built form controls.
- g) Create a new local focus on Kiaora Lane by completing the Kiaora Lands development which includes new retail shops, a library and public plaza.

### Retain and enhance pedestrian access and amenity in and around the centre

- a) Reinforce the intimate scale, active retail frontage and pedestrian amenity of the lanes and little streets in the centre.
- b) Improve the pedestrian environment by:
  - increasing connectivity through the large block bound by Cross, Bay and William Streets, and Jamberoo Lane;
  - providing building setbacks and footpaths in lanes;
  - requiring continuous awnings in nominated areas.
- c) Improve the pedestrian environment by encouraging well designed arcades and open air connections at nominated locations that complement the street and lane structure and which:
  - promote public access across private land;
  - are transition spaces between public places;
  - are activated by retail frontage;
  - have through-site visibility.

### **Improve Double Bay's built form to provide appropriate definition to the public domain**

- a) Provide direction and certainty of outcome in relation to built form to ensure:
  - a coherent street scale;
  - compatibility with existing urban fabric;
  - a variety of building types;
  - a high level of environmental amenity.
- b) Promote high quality architectural design throughout the centre that positively contributes to the streetscape.
- c) Ensure that new development is compatible with the existing built, streetscape and village character
- d) Establish building envelopes that define building height and building lines (at lower and upper levels) to provide coherent street definition.
- e) Reinforce continuous active retail frontages along street boundaries.
- f) Reinforce the presence of corner buildings addressing the public domain, recognising their importance in the centre in terms of street vistas, urban scale and identity.
- g) Include public art in significant or large-scale development.
- h) Encourage view sharing and privacy.
- i) Encourage discrete vehicle access from rear lanes, while retaining some active use and address to those lanes.
- j) Preserve the 'small shop' urban character of the centre by limiting the width of retail frontages.

### **Promote sustainable design principles and objectives in the development and use of the built environment**

- a) Promote environmentally sustainable design (ESD) principles such as conserving energy, facilitating natural ventilation and lighting, limiting the depth of buildings and providing favourable orientation.
- b) Promote developments that innovatively combine ecological, social, cultural and economic objectives.

### **Conserve and enhance the visual and environmental amenity of all buildings and places of heritage significance in the centre.**

- a) To identify character buildings within the Double Bay Centre.
- b) To ensure that alterations and additions to character buildings and heritage items are compatible in scale, form and material with these buildings and items, and adjoining developments.

### **To improve parking in the centre**

- a) Improve parking and traffic conditions in the centre.

- b) To improve traffic and parking management in the centre and minimise vehicular/pedestrian conflicts.
- c) Provide adequate parking in new developments at basement level, in the centre of blocks or in other discrete locations.
- d) Limit the impact of overflow commercial parking in predominantly residential areas.

---

## D5.4 Street character

### D5.4.1 Desired future character

---

The street is the primary organising element of urban structure. The street edge is the place where the public and private domains meet. By defining a particular vision for each street, public domain improvements and private development can be coordinated to produce a desired outcome.

This section describes the desired future character of each street in the Double Bay Centre. The Double Bay Centre Public Domain Improvements Plan (1999) should be used as a reference for works in the public domain, such as street tree planting, footpath design, street furniture and traffic devices.

The following is provided for each street in the centre:

- ▶ Existing character, which describes elements such as built form, streetscape, lighting, landscape and views;
- ▶ Desired future character, which outlines the urban design criteria for each street;
- ▶ Annotated street sections, which illustrate the existing and the desired future built form.

This information sets the context for development control described in Sections D5.5 and D5.6.

### D5.4.2 Common street strategies

---

- ▶ Strengthen the spatial definition of streets by encouraging building to the street boundary.
- ▶ Provide continuous active retail frontage at ground floor level.
- ▶ Increase street surveillance and promote a safe environment.
- ▶ Strengthen all built form on corner sites.

### D5.4.3 New South Head Road

---

#### Existing character

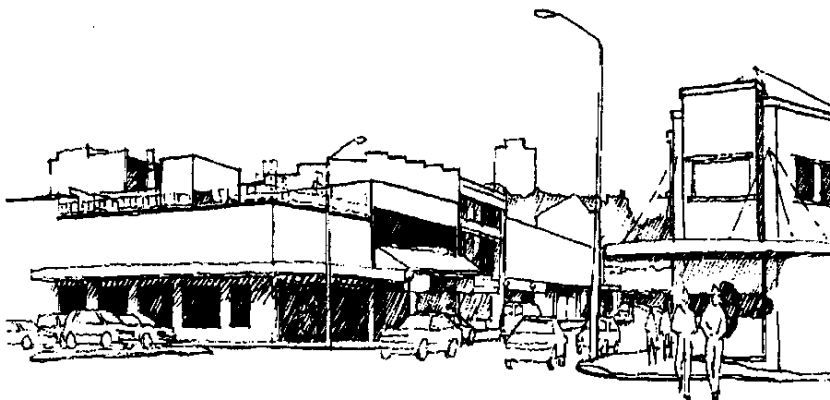
New South Head Road is a historically significant road connecting the city to South Head. The road traverses the Double Bay Centre where it has a strong curved form punctuated with

vistas of green at either end. The quality and scale of existing buildings do not yet realise the potential of the space.

**Desired future character**

- a) Accentuate the curved street geometry of New South Head Road with four and five storey buildings.
- b) Retain green vistas at each end of New South Head Road.

**Location map and section direction**



**FIGURE 12**  
Existing view towards the south west at the five way intersection of Cross Street and New South Head Road

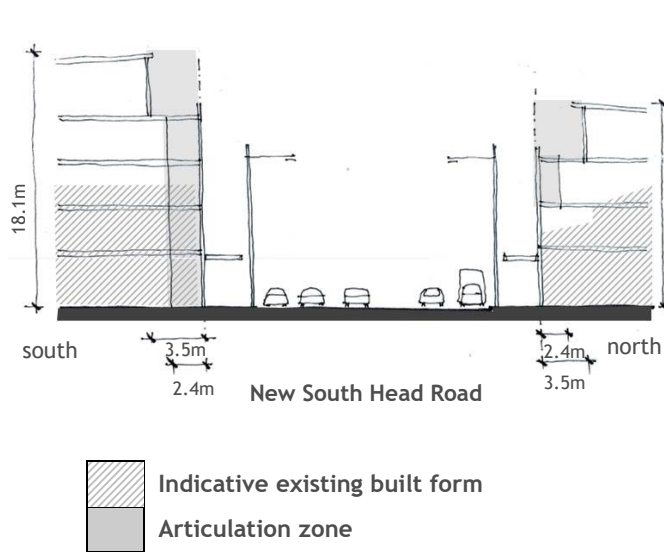


**FIGURE 13**  
Potential development at the five way intersection and New South Head Road based on the controls in this DCP

Setback development of the upper-most floor level from the street boundary

Build to the street alignment with masonry walls, articulated with deep window reveals or punched openings

Integrate sound attenuation devices into the design of the built street edge with enclosable balconies, articulated window sills, string courses, double glazing and the like



Parapets encouraged

Use the ground floor level articulation zone to encourage transition from the street to the shop – this space could also be used for outdoor dining or shop display

Provide continuous awning

### D5.4.4 Bay Street (south)

#### Existing character

Bay Street connects New South Head Road with the harbour. Its north-south orientation results in the street being sunny throughout the day. It is lined by modest buildings on narrow lots, with irregular setbacks at street level and street trees. Together the elements contribute to an intimate and relaxed atmosphere. There are a number of buildings that have been identified as

character buildings in Section 5.6.3.8 Heritage items and character buildings. These include several Victorian terraces that have been modified for retail use.

#### Desired future character

- a) Retain the existing modest, lot related building widths and retail frontages.
- b) Provide setback areas at ground level that can be used for outdoor eating or public circulation.
- c) Retain the character buildings along Bay Street.
- d) Maintain the avenue of trees.

#### Location map and section direction



**FIGURE 14** Existing view down Bay Street to Cross Street



**FIGURE 15** Potential architectural resolution and address on Bay Street (south) based on the controls in this chapter

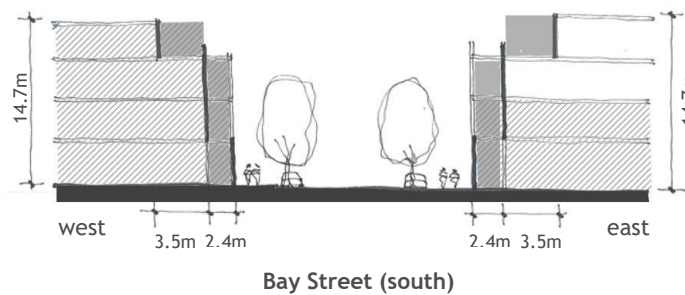


A variety of roof forms is encouraged

Balconies and rooms should overlook the street

Use adjustable screening to protect rooms from low angle summer sun

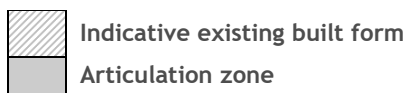
Character buildings retain existing front setback



Partially build to the street alignment with shop fronts, projecting rooms and balconies

Outdoor dining at street level is encouraged

Character buildings retain existing front setback





## D5.4.5 Bay Street (centre)

### Existing character

The central section of Bay Street is focused on Guilfoyle Park, which together with the surrounding streets, creates a generous area of open space. This space is defined and contained by the buildings on Bay Street and Guilfoyle Avenue.

### Desired future character

- a) Lot amalgamations on blocks in proximity to Guilfoyle Park.
- b) Expand the public domain at street level and improve the civic character with street level building colonnades that face central Bay Street and Guilfoyle Park. Provide a built form that responds to the scale and civic importance of Guilfoyle Park.
- c) Higher buildings are permitted around the park to provide appropriate definition of the space.

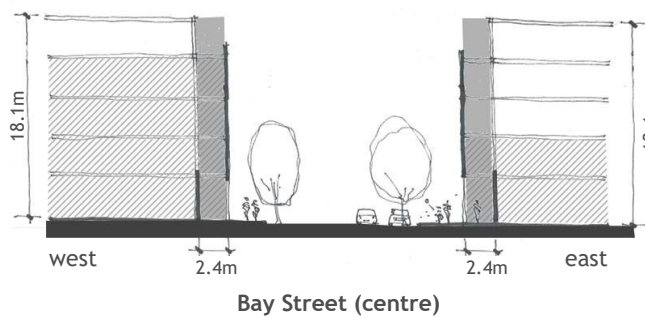
Location map and section direction



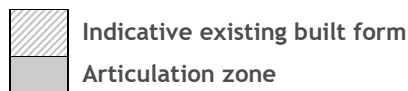
A variety of roof forms is encouraged

Build to street alignment with loggias and balconies

Provide adjustable screening to protect rooms from low angle summer sun



Design colonnades including the size and spacing of the columns integral with the building design and with regard to adjoining colonnades if they exist



## D5.4.6 Knox Street

### Existing character

Knox Street is located at the physical centre of Double Bay, and has high value retail premises. The street section is asymmetrical with the Cosmopolitan Centre having a higher form to the south. The lower built edge to the north is fragmented and varied, and some buildings suggest street level connections to other streets. The street has a pronounced curve which is articulated by the buildings on the north side and the lower levels of the Cosmopolitan Centre.

### Desired future character

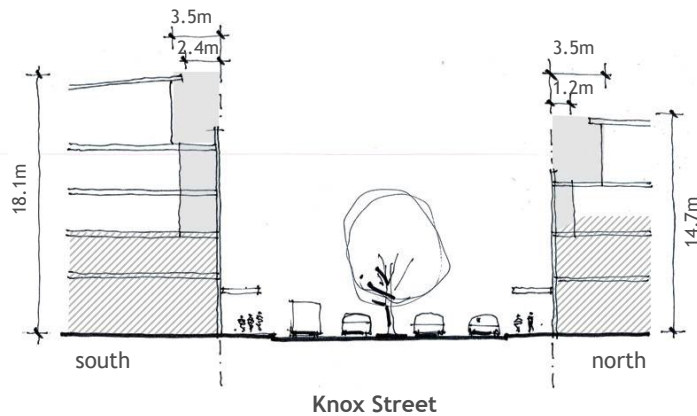
- a) Retain the asymmetrical street section.
- b) Accentuate the curved street geometry of Knox Street by encouraging building to the street boundary and continuous awning cover on the south side.
- c) Retain street level connections to Knox Lane.
- d) Allow 4 storey built forms on 50% of each site frontage to Knox Lane. See Control Drawings for more information.

Location map and section direction

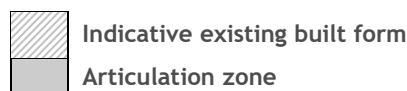


Generally setback level 5 development from the street boundary

Continuous awning  
Build to street alignment with articulated deep window reveals and balconies



Extend median planting of Oriental Plane trees



## D5.4.7 Cross Street

### Existing character

The subdivision pattern on each side of Cross Street differs significantly resulting in highly differentiated built form. The southern side of the street has wide and shallow lots, with arcades and sunny courtyards, which perforate the built form. The large buildings on the northern side are generally coarsely modelled and articulated. Corner buildings on Cross Street do not, in the main, provide good street definition.

### Desired future character

- a) Unify the street on the north side by building to the street boundary.
- b) Retain street level connections to Knox Lane.
- c) Allow 4 storeys on 50% of each site frontage to Knox Lane. See Control Drawings for more information.
- d) Encourage arcades and courtyards on the south side that cater for outdoor eating and informal gathering.
- e) Strengthen built form on corner sites.

### Location map and section direction



**FIGURE 16** Existing view down Cross Street at the corner of Transvaal Avenue



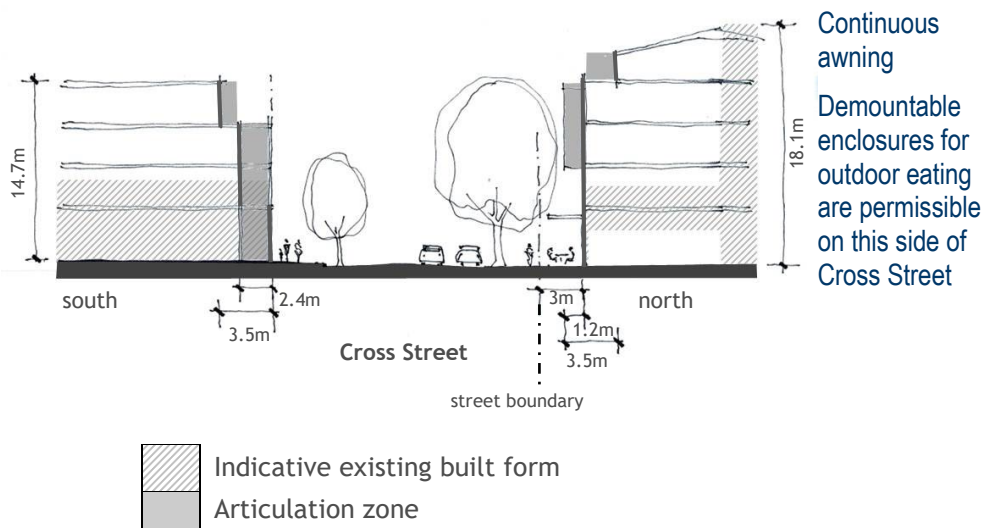
**FIGURE 17** Potential street character on Cross Street based on the proposed controls



Set back level 4 development from the street boundary

Use the ground level articulation zone to create courtyards or outdoor rooms which activate the street edge

Continuous retail frontage



---

### D5.4.8 The Lanes

---

#### Existing character

Most of the lanes are currently the “back” of lots. These are characterised by their lack of pedestrian amenity and extensive vehicle crossovers, and tend to be visually blighted by service areas and unscreened rubbish areas.

#### Desired future character

- a) Facilitate the service role of lanes, while encouraging increased active retail frontage.
- b) Improve pedestrian amenity by providing adequate footpaths, limiting the width and numbers of vehicle crossovers, setting buildings back on one side and preserving natural daylight to the lanes.
- c) Enhance the spatial definition of lanes with ground and first floor building lines and buildings up to two storeys in height.

---

### D5.4.9 Knox Lane

---

#### Existing character

Knox Lane has an intimate scale which is partly due to the lane's changing alignment and related spatial enclosure. Physical and visual connection to other spaces at street level is primarily via

through-site connections to Knox Street and courtyards to Cross Street. The spatial definition along the lane varies although most of the buildings are two to three storeys.

**Desired future character**

- a) Retain and enhance the varied spatial definition of Knox Lane.
- b) Retain and enhance the honeycomb of arcades and courtyards which connect Knox Street to Cross Street.
- c) Encourage visual and physical connections between Knox and Cross Streets using:
  - arcaded and/or outdoor connections;
  - north oriented courtyards; and
  - arcade and courtyard creating buildings, which may vary from the control drawings in Section 5.5.8.

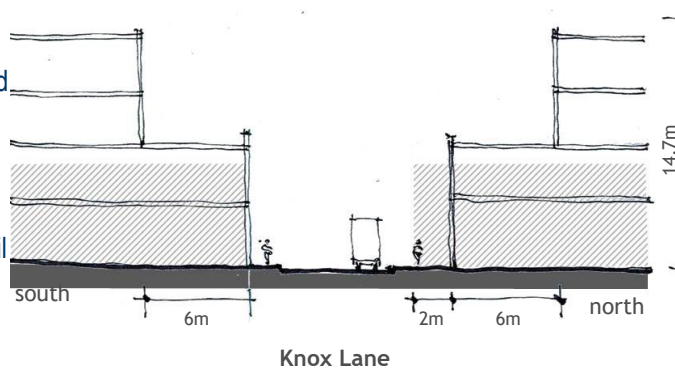
Location map and section direction




The use of roof terraces as open space is encouraged

Widen footpath to increase pedestrian activity

Increase active retail frontage



 Indicative existing built form

Two storey buildings along the lane frontage may be interspersed with arcades and courtyards.

Each development site may be permitted to build to 4 storeys on 50% of the Knox Lane frontage if it is interspersed with 2 storey development.

The build-to line is setback to expand the public domain at street level and improve pedestrian amenity

## D5.4.10 Short Street

### Existing character

The building on the northern side of Short Street, and its extensive vehicle crossovers, establishes an overbearing scale and unmodulated façade which dominates the spatial quality of Short Street.

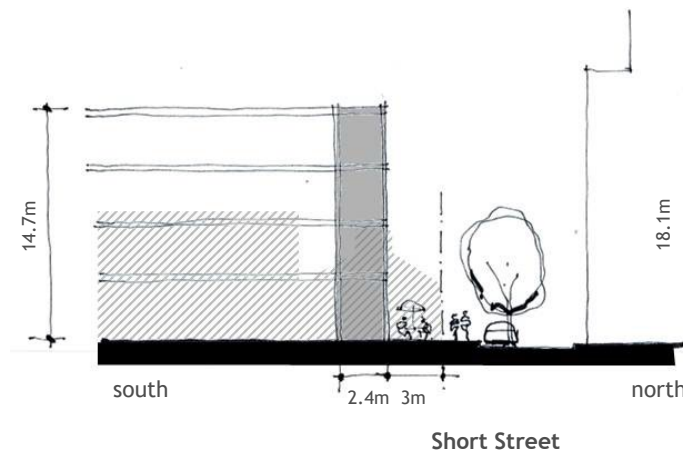
### Desired future character

- a) Increase active retail frontage.
- b) Moderate the scale of built form along the north side of the lane with buildings of predominantly two storeys, set back 2m from the lane boundary, and interspersed with four storey development.
- c) Apply a 3m setback on No.2 Short Street at the Short Street frontage.
- d) Protect the amenity of the lane by preventing uninterrupted four storey buildings constructed to the street boundary along the northern built edge.
- e) Widen footpath to southern side of Short Street.

Location map and section direction





The building line is setback to expand the public domain at street level and improve pedestrian amenity



Each development site may be permitted to build to 4 storeys on 50% of Short Street frontage if it is interspersed with 2 storey development.

Increase active retail frontage

-  Indicative existing built form
-  Articulation zone

## D5.4.11 Gumtree Lane

### Existing character

Gumtree Lane is spatially defined by the discontinuous two storey built form on its west side and the lane geometry that creates a central triangular site.

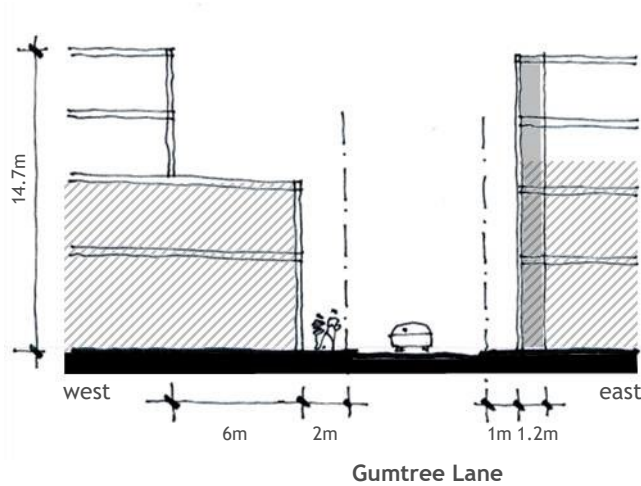
### Desired future character

- a) Retain the two storey built form and 2m setback on the west side.
- b) Apply a 1m setback to the eastern side of Gumtree Lane.
- c) Increase the spatial definition of the lane, and street surveillance with an articulated building addressing the lane from the central triangular site.

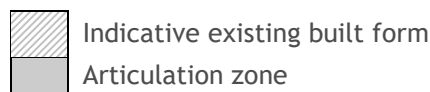
Location map and section direction



The use of roof terraces as open space is encouraged  
Increase active retail frontage



The building line is set back to expand the public domain at street level and improve pedestrian amenity





## D5.4.12 Goldman Lane

### Existing character

The character of Goldman Lane is quite intimate with restaurant entrances on both sides of the lane and through-site links connecting to New South Head Road. Its spatial quality could be improved by strengthening the built form along each side.

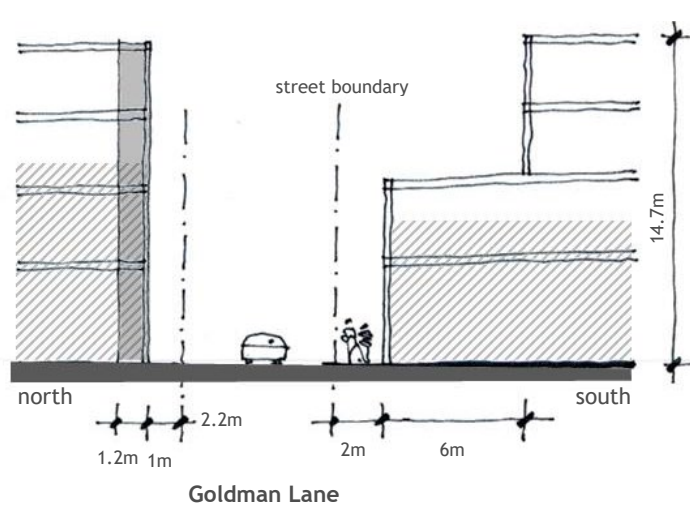
### Desired future character

- a) Increase the spatial definition of the lane and street surveillance with an articulated building addressing the lane from the central triangular site.
- b) Retain and extend the 2m setback on the south-eastern side of Goldman Lane.
- c) Apply a 1m setback on the north-western side of Goldman Lane.

Location map and section direction



The building line is setback to expand the public domain at street level and improve pedestrian amenity



The use of roof terraces as open space is encouraged  
Increase active retail frontage



Indicative existing built form  
Articulation zone

## D5.4.13 Kiaora Lane

### Existing character

The character of Kiaora Lane is compromised by its current “back of house” status, with loading vehicles, exposed on-site loading bays and rubbish bins. Recent lane widening creates a framework within which to improve the general character and particularly pedestrian amenity. A setback zone to its north side has been partially built.

Kiaora Lands occupies the southern side of the laneway. It comprises a three storey retail development with public space opposite the Double Bay Library and public car park. An arcade provides access from Kiaora Lands to New South Head Road near Knox Street.

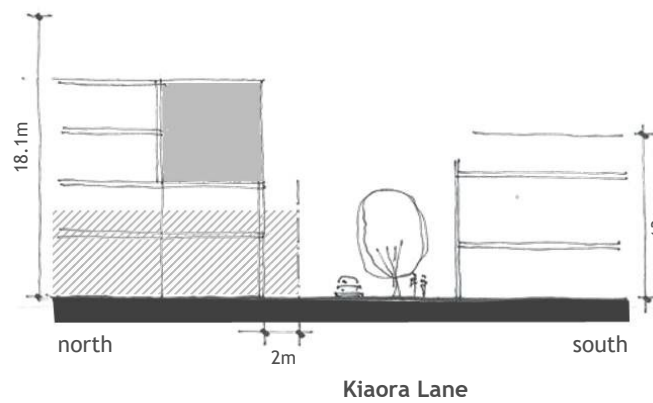
### Desired future character

- a) Improve the civic quality of the lane and this side of the centre with a public building and public square adjacent to a through-site link to New South Head Road.
- b) Enhance pedestrian amenity with a car park on the existing car park site with active retail addressing the lane.
- c) Moderate the scale of built form along the north side of the lane with buildings of predominantly two storeys, set back 2m from the lane boundary, and interspersed with four storey development.
- d) Protect the amenity of the lane by preventing uninterrupted four storey buildings constructed to the street boundary along the northern built edge.

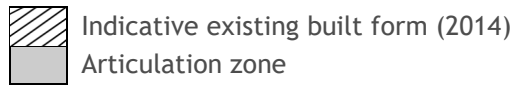
Location map and section direction



A variety of roof forms is encouraged  
4 storey development may be permitted on 50% of the site frontage.  
A 2m setback is required to expand the public domain at street level and improve pedestrian amenity



Provide an active retail edge to the lane  
Provide retail on the ground floor with car parking above or below retail levels.  
Colonnade edging the lane



Note: Refer to the built form envelopes in Appendix 2 Kiaora Lands for objectives and strategy for Kiaora Lane as it relates to the Kiaora Lane site.

---

## D5.5 Built form envelopes: Control drawings

### D5.5.1 Urban form methodology

---

This section contains control drawings which show building envelopes for every site in the Double Bay Centre.

The envelopes generally establish:

- ▶ four storey heights along streets;
- ▶ two storey heights along lanes; and
- ▶ lesser building depths above the first floor to achieve high amenity development flexible for residential or commercial uses.

This framework has been tailored to each site, taking into consideration its particular characteristics. These include:

- ▶ the relationship of buildings to the public domain such as the street, public park or square;
- ▶ the desired future character of the street in which the site is situated;
- ▶ its size and orientation;
- ▶ the significance of existing buildings and landscape;
- ▶ its optimum development potential; and
- ▶ managing the impact of its development on adjoining commercial or residential properties.

This urban form methodology defines a physical outcome for the centre, while encouraging innovative architectural design within the building envelopes. It provides more certainty of outcome for Council, community and site owners.

Controls for levels 1-2 (ground and first floor) differ to those for levels 3-5.

At street level the integration of retail and commercial uses, vehicular access and street awnings, are the primary needs to be considered. Upper floor level envelopes are designed to facilitate quality residential and commercial development.

For this reason there are two control drawings for each urban block in the Double Bay Centre, illustrating the level 1 and 2 and level 3-5 envelopes for every site. Summary built form drawings for the Double Bay Centre are provided in Sections 5.5.3 and 5.5.4.

The maximum floor space permitted is determined by the floor space ratio (FSR) in Woollahra LEP 2014. All development must comply with the applicable FSR control.















The control drawings use building envelopes to illustrate how floor space is to be distributed over the site. The envelopes have been designed to achieve a loose fit with the FSR to encourage building articulation, through-site connections, and some variation of building form and building character. The envelopes allow varied and innovative design; they are not to be used as a justification for FSR in excess of the LEP control.

---

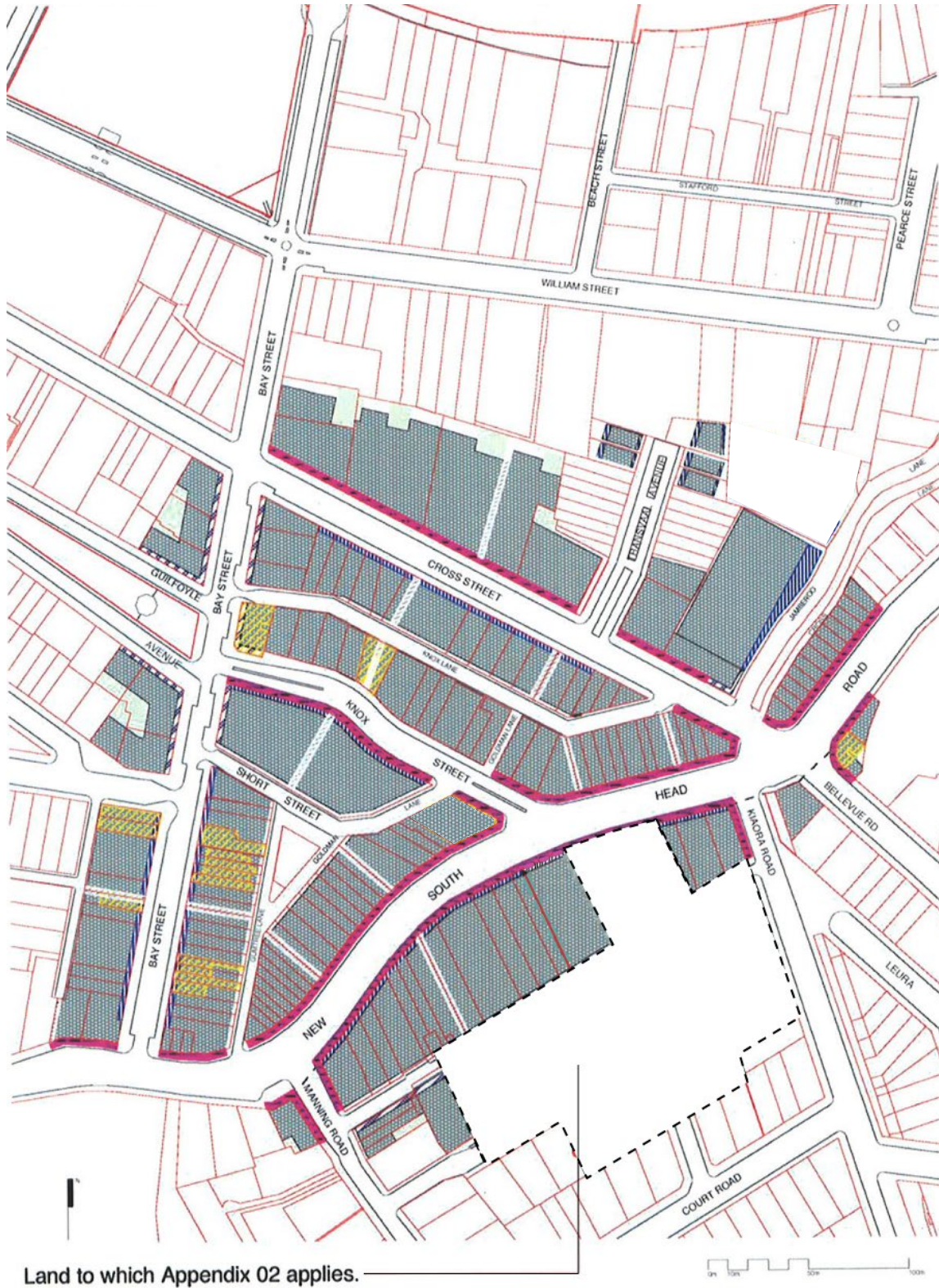
A summary of some of the development controls in Section D5.6 such as setbacks and building articulation are provided with the control diagrams. The control drawings in this section should be read in conjunction with Section D5.6 which provides further explanation, and includes other relevant controls.

## D5.5.2 Explanatory legend

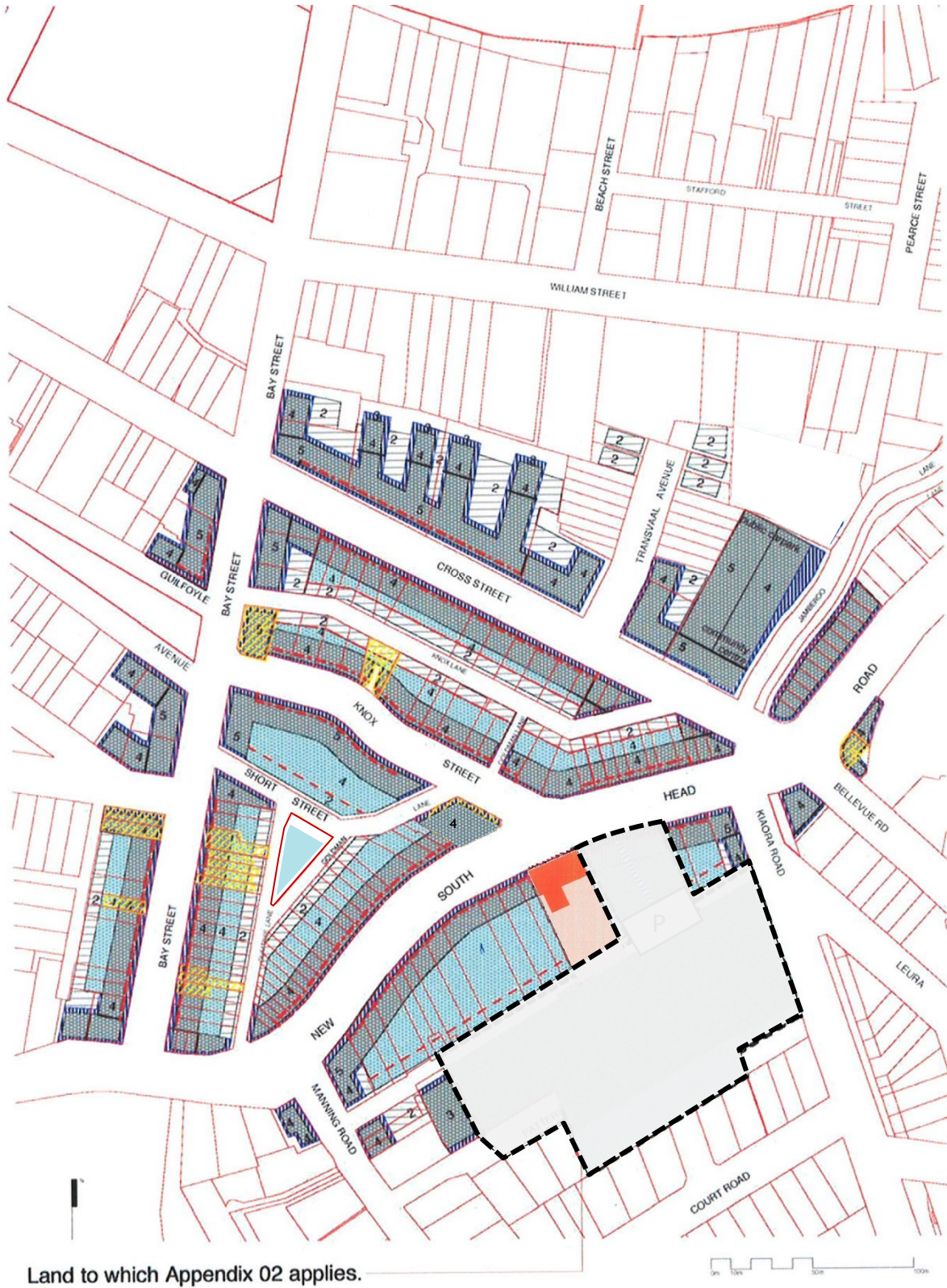
The control drawings incorporate the following graphic symbols:

	<b>BUILDING ENVELOPE</b>
	100% of this area per floor may be built on
	50% of this area per floor may be built on
	Area for building articulation Refer to 6.3.3 for percentage of floor space permitted
	Possible roof, roof terrace or courtyard below
<b>No OF LEVELS</b>	<b>MAXIMUM PERMISSIBLE BUILDING HEIGHT</b>
<b>2</b>	8m height
<b>3</b>	11.5m height
<b>4</b>	14.7m height
<b>5</b>	18.1m height
	<b>BUILDING LINES</b>
	Continuous building line - 100%
	Building line 50% - 100%
	<b>UPPER LEVEL SETBACK</b>
	3.5m setback of uppermost floor level (either level 4 or 5)
	<b>RELATIONSHIP TO THE PUBLIC DOMAIN</b>
	Colonnade
	Continuous awning
	Arcades and walkways (indicated on 5.5.3 Double Bay built form envelopes - ground and first floor)
	<b>HERITAGE ITEMS + CHARACTER BUILDINGS</b> Refer to 6.3.8 Heritage items character buildings
	Sites with heritage listed items
	Footprint of heritage listed building
	Character buildings
	<b>LANDSCAPED AREA</b>

### D5.5.3 Double Bay Centre built form envelopes, ground and first floors (levels 1 and 2)



### D5.5.4 Double Bay Centre built form envelopes (levels 3 and above)







### D5.5.5 Control drawing 1



Control drawing that shown in clause A2.4

No OF LEVELS	
2	8m
3	11.5m
4	14.7m
5	18.1m

BUILDING ENVELOPE	
	100% of this area per floor may be built on
	50% of this area per floor may be built on
	Area for building articulation. Refer to 6.3 for configuration
	Possible roof, roof terrace or courtyard below
BUILDING LINES	
	Continuous building line - 100%
	Building line 50% - 100%

	UPPER LEVEL SETBACK 3.5m setback of uppermost floor level (either level 4 or 5)
	RELATIONSHIP TO THE PUBLIC DOMAIN Continuous awning
	HERITAGE ITEMS Sites with heritage listed items
	Footprint of heritage listed building
	LANDSCAPED AREA

### Control summary

#### 5.6.3 Urban character

##### Articulation

At the street frontage on levels 2-5 articulation comprises 80% internal space 20% external space.  
For the ground floor along New South Head Road, at least 60% of the articulation zone is external space.

See Section 5.6.3.3 Building articulation for more information.

##### Setbacks

Zero front setback to New South Head Road, Manning Road and Kiaora Road.  
2m rear setback on Kiaora Lane.

See Section 5.6.3.4 Setbacks for more information.

##### Corner buildings

Selected corner sites are eligible for bonus FSR under Woollahra LEP 2014.

See Section 5.6.3.5 Corner buildings for more information.

##### Heritage items

New development or work to the Golden Sheaf Hotel at 423-431 New South Head Road must be compatible with the significance of this heritage item.

See Section 5.6.3.8 Heritage items and character buildings for all heritage controls and Woollahra LEP 2014.

Note: Section 5.6.3 also includes Architectural resolution and Roof design.

#### 5.6.5 Amenity

##### Landscaped areas

357-359 New South Head Road includes 50m<sup>2</sup> of landscaped area.

See also:

- ▶ Section 5.6.4 Relationship to public domain
- ▶ Section 5.6.6 Solar access and natural ventilation



#### Control drawing 1

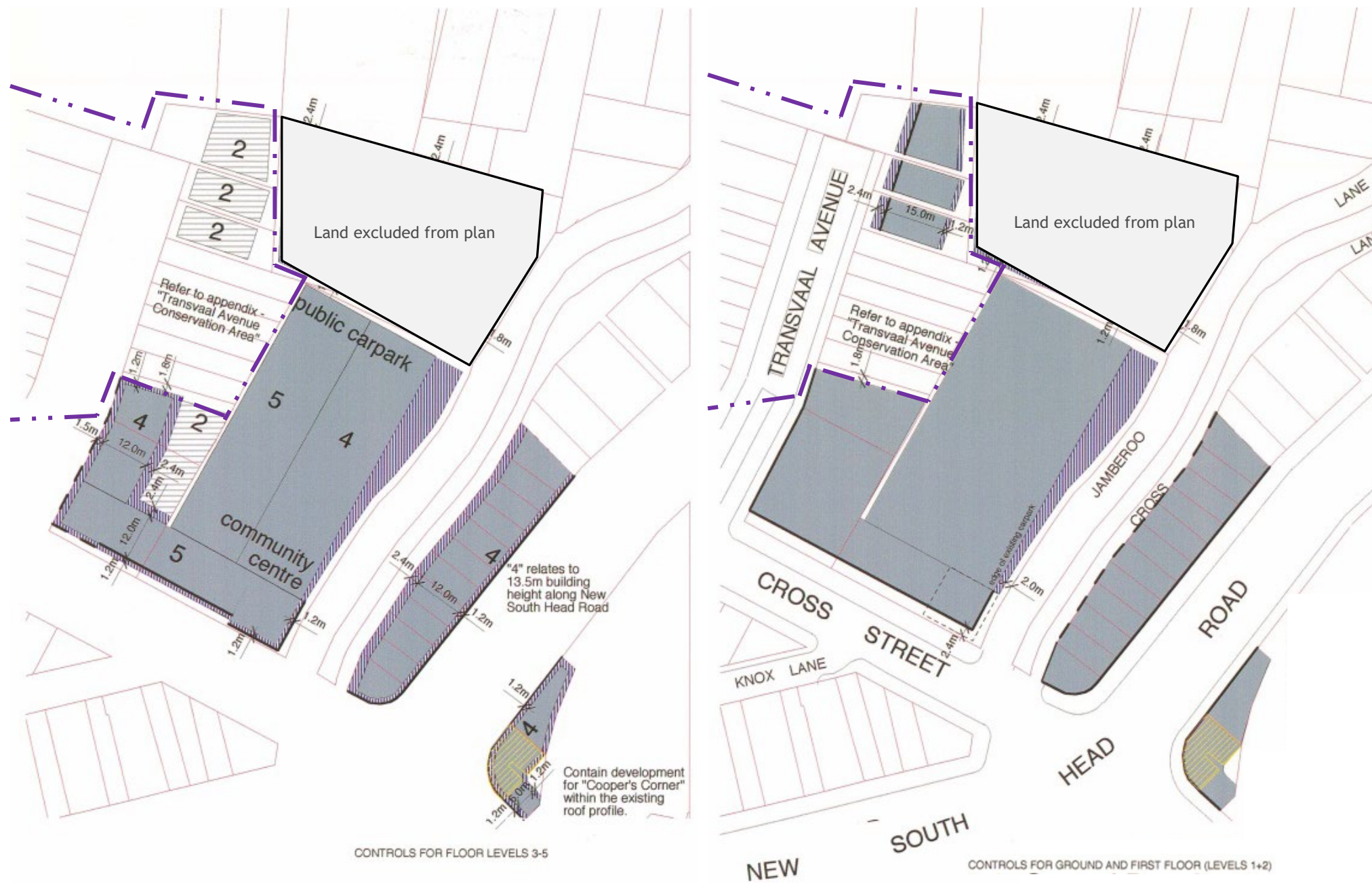
New South Head Road/  
Kiaora Road/  
Manning Road

Indicates location of street sections



D5.5.6 Control drawing 2

Control summary



5.6.3 Urban character

Articulation

New South Head Road: On levels 2-5, up to 80% of the street façade articulation zone must be internal space with the balance of the area used for external space.

Elsewhere: At the street frontage, articulation on all levels should be comprised of up to 40% internal space with 60% external space.

See Section 5.6.3.3 Building articulation for more information.

Setbacks

Ground floor: Zero front setback to New South Head Road, Cross Lane and Transvaal Avenue, except Nos. 17-19 Transvaal Avenue which must be setback to align with adjoining cottages in the HCA. A 2.4m setback applies on Cross Street between Transvaal Avenue and Jamberoo Lane.

Levels 2-5: Setbacks to match ground floor except at the corners of Transvaal Avenue and Jamberoo Lane as illustrated.

See Section 5.6.3.4 Setbacks for more information.

Character buildings

Character building: Cooper's Corner, 475 New South Head Road.

See Section 5.6.3.8 Heritage items and character buildings for controls for character buildings.

Heritage conservation areas

Refer to Appendix 1 for development in the Transvaal Heritage Conservation Area.

Note: Section 5.6.3 also includes Architectural resolution and Roof design.

See also:

- ▶ 5.6.4 Relationship to public domain
- ▶ 5.6.5 Amenity
- ▶ 5.6.6 Solar access and natural ventilation

No OF LEVELS	
2	8m
3	11.5m
4	14.7m
5	18.1m

BUILDING ENVELOPE	
	100% of this area per floor may be built on
	Area for building articulation. Refer to 6.3 for configuration
	Possible roof, roof terrace or courtyard below
BUILDING LINES	
	Continuous building line - 100%
	Building line 50% - 100%

	CHARACTER BUILDINGS Character buildings
	Heritage Conservation Area



Control drawing 2

Transvaal Avenue/  
Cross Street/  
Jamberoo Lane



D5.5.7 Control drawing 3

Control summary

5.6.3 Urban character

Articulation

At the street frontage, articulation on levels 2-5 should be comprised of up to 40% internal space with 60% external space.

See Section 5.6.3.3 Building articulation for more information.

Setbacks

Ground floor: Zero front setback to Bay Street. 3m setback on Transvaal Avenue except for Nos. 18-20 which must be setback to align with adjoining cottages in the HCA. 3.5m on Cross Street between Bay Street and Transvaal Avenue.

Levels 2-5: Setbacks to match ground floor except at the corner of Cross Street and Transvaal Avenue as illustrated. Balconies on levels 3 and 4 can project 1.2m into the setback, except balconies on level 4 if it is the top level.

See Section 5.6.3.4 Setbacks for more information.

Heritage conservation areas

Refer to Appendix 1 for development within the Transvaal Avenue Heritage Conservation Area.

Note: Section 5.6.3 also includes Architectural resolution and Roof design.

See also:

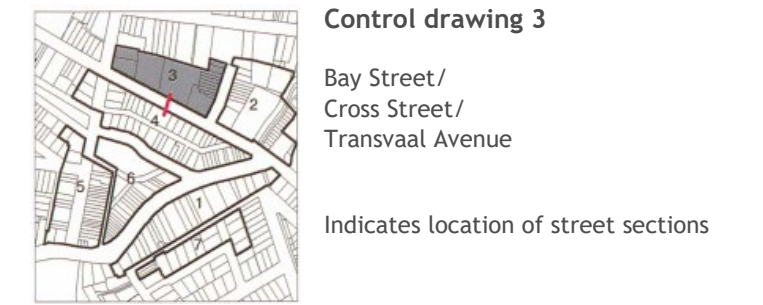
- ▶ 5.6.4 Relationship to public domain
- ▶ 5.6.5 Amenity
- ▶ 5.6.6 Solar access and natural ventilation



CONTROLS FOR FLOOR LEVELS 3-5

CONTROLS FOR GROUND AND FIRST FLOOR (LEVELS 1 + 2)

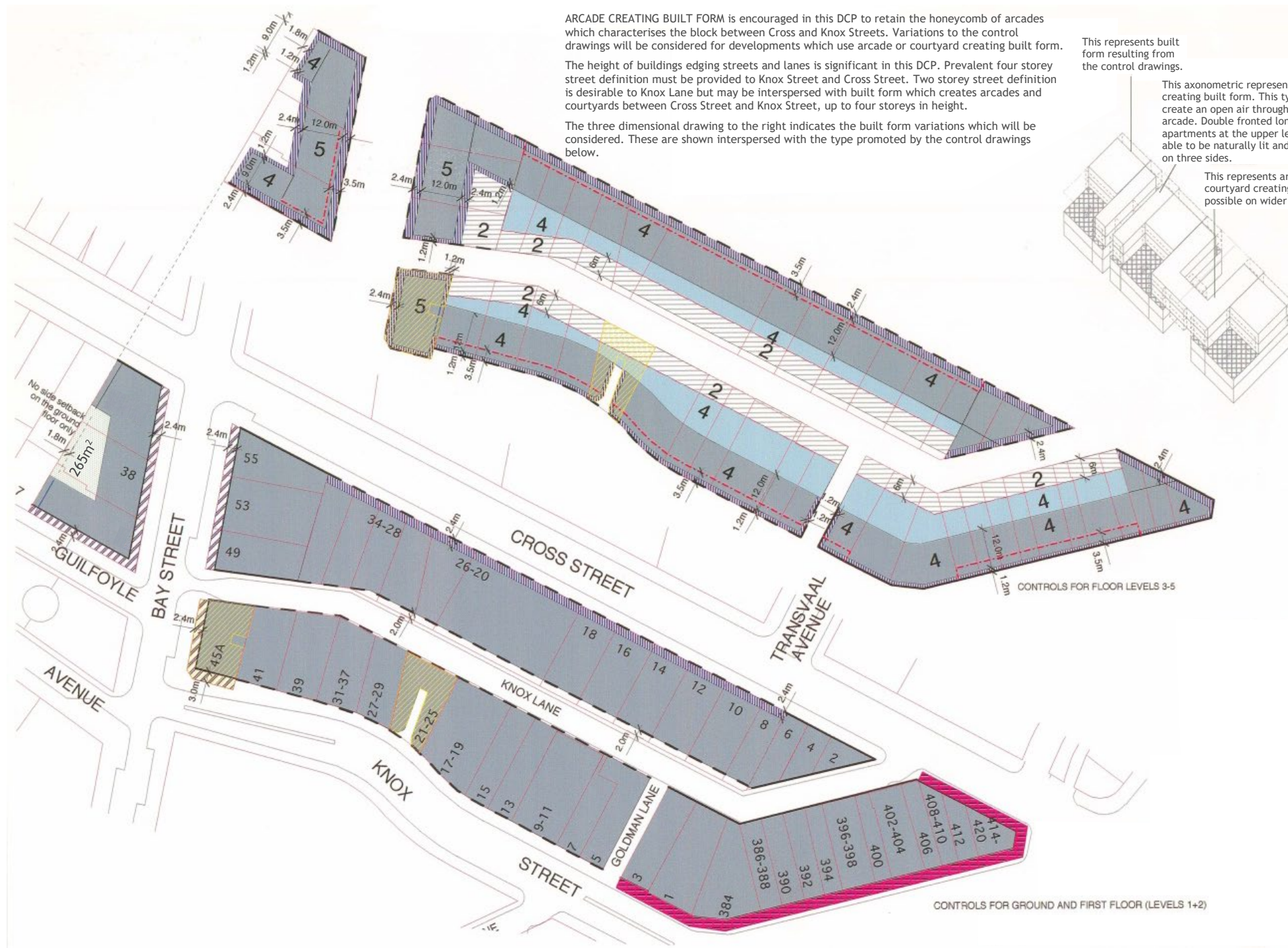
<p>No OF LEVELS</p> <p><b>2</b> 8m</p> <p><b>3</b> 11.5m</p> <p><b>4</b> 14.7m</p> <p><b>5</b> 18.1m</p>	<p><b>BUILDING ENVELOPE</b></p> <p>■ 100% of this area per floor may be built on</p> <p>▨ Area for building articulation. Refer to 6.3 for configuration</p> <p>▤ Possible roof, roof terrace or courtyard below</p> <p><b>BUILDING LINES</b></p> <p>— Continuous building line - 100%</p> <p>- - Building line 50% - 100%</p>	<p><b>UPPER LEVEL SETBACK</b></p> <p>- - - 3.5m setback of uppermost floor level (either level 4 or 5)</p> <p><b>RELATIONSHIP TO THE PUBLIC DOMAIN</b></p> <p>▨ Continuous awning</p> <p>- · - · Heritage Conservation Area</p>
--	--	---





D5.5.8 Control drawing 4

Control summary



5.6.3 Urban character

Articulation

Cross Street: On the ground floor, internal space can occupy up to 100% of articulation zone. On levels 2-5, up to 40% of the articulation zone may be internal or external space.

New South Head Road: On levels 2-5, up to 80% of the street façade articulation zone must be internal space with the balance of the area used for external space.

Setbacks

Ground floor: A zero front setback applies except in Bay Street and Guilfoyle Avenue where a 2.4m setback applies, and at the Knox Street frontage of 45A Bay Street where a 3m setback applies.

Levels 4-5: A 3.5m setback applies to the uppermost level as indicated.

Corner buildings

Selected corner sites are eligible for bonus FSR under Woollahra LEP 2014.

See Section 5.6.3.5 Corner buildings for more information.

Character buildings

Character buildings: 45A Bay Street and 21-25 Knox Street.

See Section 5.6.3.8 Heritage items and character buildings for controls for character buildings.

Note: Section 5.6.3 includes information on Architectural resolution and Roof design.

5.6.4 Relationship to public domain

Colonnades

Colonnades must be constructed on the ground floor frontage of Guilfoyle Avenue, Bay Street and at the Bay Street frontage of 45A Bay Street.

Note: Section 5.6.4 includes more information on colonnades and a section on awnings.

5.6.5 Amenity

Landscaped areas

38 Bay Street must include 265m<sup>2</sup> of landscaped area.

See Section 5.6.6 Solar access and natural ventilation also.

<b>No OF LEVELS</b>	<b>BUILDING ENVELOPE</b>	<b>UPPER LEVEL SETBACK</b>
2 8m	100% of this area per floor may be built on	3.5m setback of uppermost floor level (either level 4 or 5)
3 11.5m	50% of this area per floor may be built on	<b>RELATIONSHIP TO THE PUBLIC DOMAIN</b>
4 14.7m	Area for building articulation. Refer to 6.3 for configuration	Colonnade
5 18.1m	Possible roof, roof terrace or courtyard below	Continuous awning
	<b>BUILDING LINES</b>	<b>CHARACTER BUILDINGS</b>
	Continuous building line - 100%	Character buildings
	Building line 50% - 100%	<b>LANDSCAPED AREA</b>

**Control drawing 4**

Knox Street/  
Bay Street/  
Cross Street  
New South Head Road Option 1

Indicates location of street sections





D5.5.9 Control drawing 5

Control summary

5.6.3 Urban character

Articulation

Bay Street: On the ground floor, internal space can occupy up to 100% of articulation zone. On levels 2-5, up to 40% of the articulation zone may be internal or external space. See Section 5.6.3.3 Building articulation for more information.

Setbacks

Ground floor: Zero front setback except for Nos. 28 and 30-36 Bay Street and 2 Guilfoyle Avenue which require a 2.4m for colonnades. A 2m rear setback applies to Gumtree Lane and a 0.7m setback applies to part of Brooklyn Lane.

Levels 2-5: Setbacks to match ground floor, except level 4 which must be setback 3.5m as indicated along Bay Street.

See Section 5.6.3.4 Setbacks for more information.

Character buildings

Character buildings are located at 14, 24-26, 9-15 and 29-37 Bay Street.

See Section 5.6.3.8 Heritage items and character buildings for controls for character buildings.

Note: Section 5.6.3 includes Architectural resolution and Roof design.

1.6.4 Relationship to public domain

Colonnades

Colonnades must be constructed on the ground floor frontage of Guilfoyle Avenue and Bay Street.

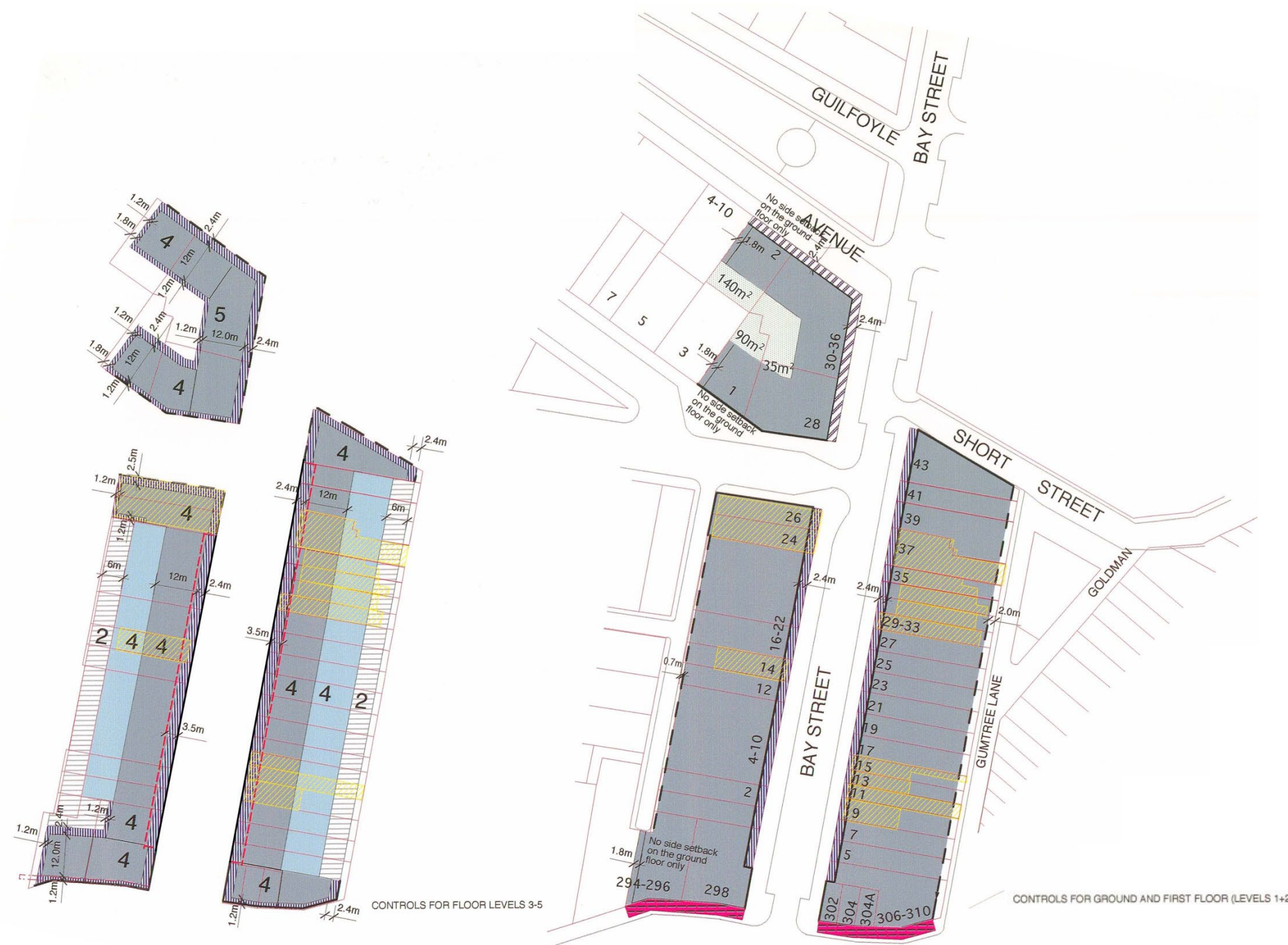
Note: Section 5.6.4 includes more information on colonnades and a section on awnings.

1.6.5 Amenity

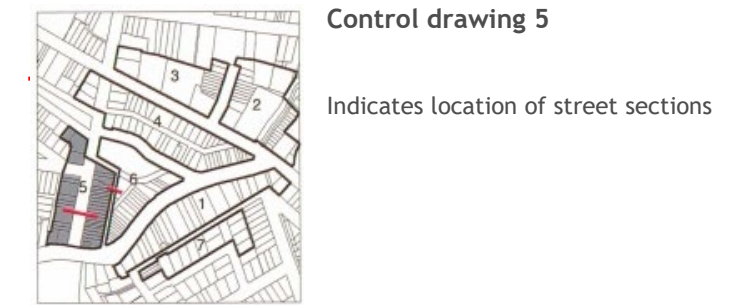
Landscaped areas

28 and 30-36 Bay Street and 2 Guilfoyle Avenue must include landscaped areas as indicated.

See Section 5.6.6 Solar access and natural ventilation for more information.



<b>No OF LEVELS</b>	<b>BUILDING ENVELOPE</b>	<b>UPPER LEVEL SETBACK</b>
2 8m	100% of this area per floor may be built on	3.5m setback of level 4
3 11.5m	50% of this area per floor may be built on	<b>RELATIONSHIP TO THE PUBLIC DOMAIN</b>
4 14.7m	Area for building articulation. Refer to 5.6.3.3 for configuration	Colonnade
5 18.1m	Possible roof, roof terrace or courtyard below	Continuous awning
	<b>BUILDING LINES</b>	<b>CHARACTER BUILDINGS</b>
	Continuous building line - 100%	Character buildings
	Building line 50% - 100%	<b>LANDSCAPED AREA</b>





D5.5.10 Control drawing 6

Control summary

5.6.3 Urban character

Articulation

New South Head Road: On levels 3-5, up to 80% of the street façade articulation zone must be internal space with the balance of the area used for external space.

Knox Street: On the ground floor, internal space can occupy up to 100% of articulation zone. On levels 2-5, up to 40% of the articulation zone may be internal space

See Section 5.6.3.3 Building articulation for more information.

Setbacks

The following setbacks apply: Bay Street, ground floor - 2.4m. 320-366 New South Head Road - 2m rear setback. 2-22 Knox Street 2m to Short Street and Goldman Lane. The uppermost floor of levels 4 or 5 at 2-22 Knox Street and 316-374 New South Head Road - 3.5m.

See Section 5.6.3.4 Setbacks for more information.

Note: Section 5.6.3 also includes Architectural resolution and Roof design.

5.6.4 Relationship to public domain

Awnings

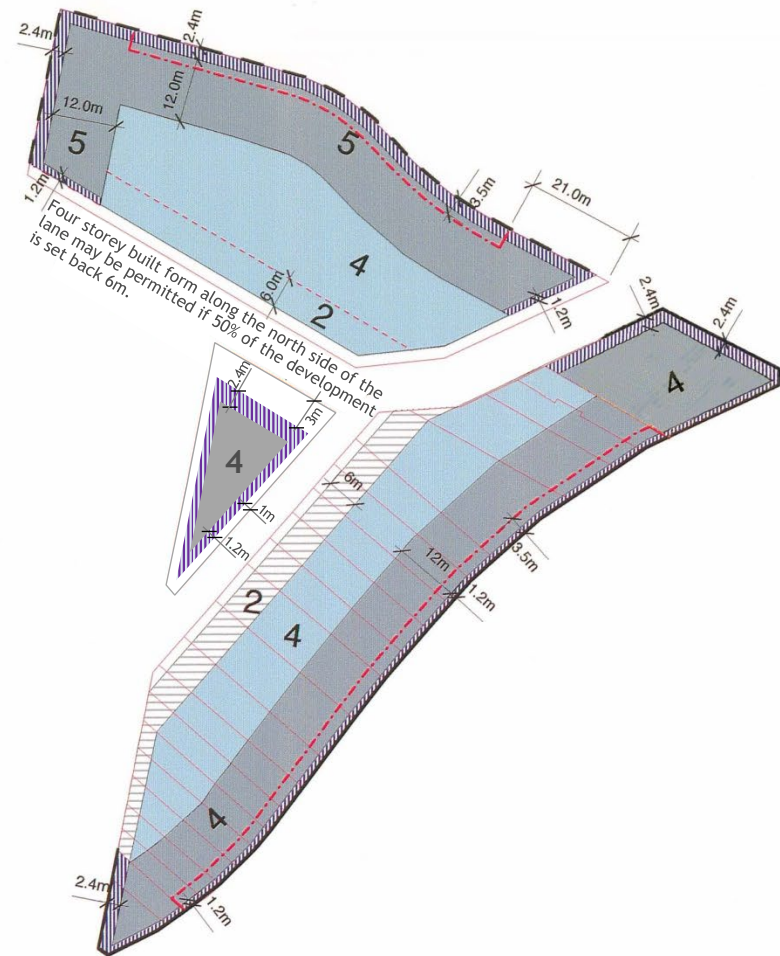
A continuous awning must be provided at the frontage of properties on New South Head Road and Knox Street.

See Section 5.6.4.1 Awnings for more information.

Colonnades

Colonnades must be constructed on the ground floor frontage of Bay Street.

See Section 5.6.4.2 Colonnades for more information.



CONTROLS FOR FLOOR LEVELS 3-5



CONTROLS FOR GROUND AND FIRST FLOOR (LEVELS 1 + 2)

No OF LEVELS

- 2 8m
- 3 11.5m
- 4 14.7m
- 5 18.1m

BUILDING ENVELOPE

- 100% of this area per floor may be built on
- 50% of this area per floor may be built on
- Area for building articulation. Refer to 5.6.3.3 for configuration
- Possible roof, roof terrace or courtyard below

BUILDING LINES

- Continuous building line - 100%
- Building line 50% - 100%

UPPER LEVEL SETBACK

- 3.5m setback of uppermost floor level (either level 4 or 5)

RELATIONSHIP TO THE PUBLIC DOMAIN

- Colonnade
- Continuous awning



Control drawing 6

New South Head Road/  
Kiaora Road/  
Manning Road

Indicates location of street sections



D5.5.11 Control drawing 7



Control summary

5.6.3 Urban character

Articulation

On levels 3-4 up to 40% of the street façade articulation zone may be internal space with 60% external space-

See Section 5.6.3.3 Building articulation for more information.

Setbacks

2.4m setback applies to the ground floor of 4 Manning Road and 11 Patterson Street on Kiaora Lane.

See Section 5.6.3.4 Setbacks for more information.

Note: Section 5.6.3 also includes Architectural resolution and Roof design.

5.6.5 Amenity

Landscaped areas

8 Manning Road must include 90m<sup>2</sup> of landscaped area.

See Section 5.6.6 Solar access and natural ventilation for more information.

No OF LEVELS	
2	8m
3	11.5m
4	14.7m
5	18.1m

BUILDING ENVELOPE	
	100% of this area per floor may be built on
	50% of this area per floor may be built on
	Area for building articulation. Refer to 5.6.3.3 for configuration
	Possible roof, roof terrace or courtyard below
BUILDING LINES	
	Continuous building line - 100%
	Building line 50% - 100%

	UPPER LEVEL SETBACK 3.5m setback of uppermost floor level (either level 4 or 5)
	RELATIONSHIP TO THE PUBLIC DOMAIN Colonnade
	LANDSCAPED AREA

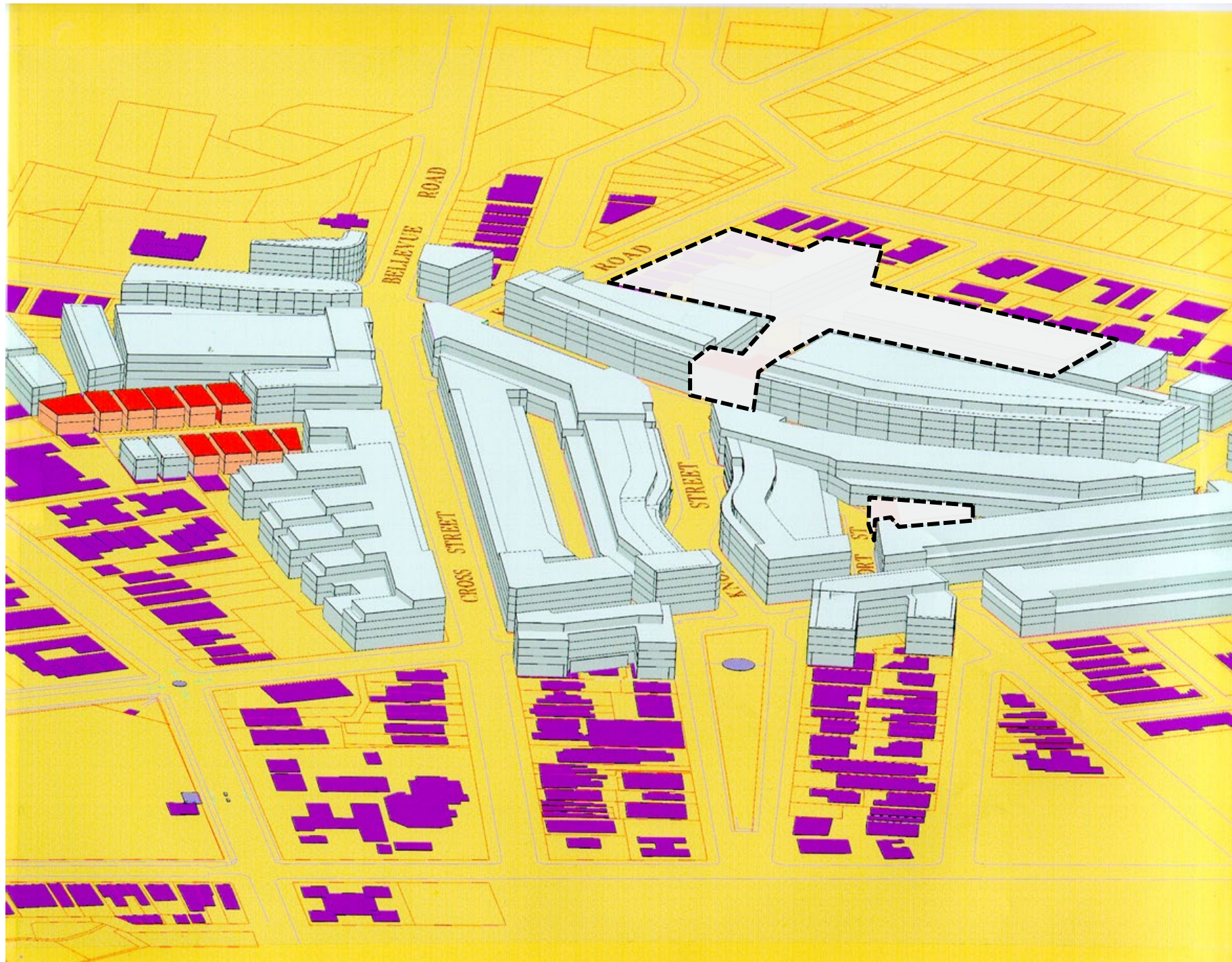


Control drawing 7

Indicates location of street sections



D5.5.12 View 1: 3D view of building envelopes



**View east along Cross Street**

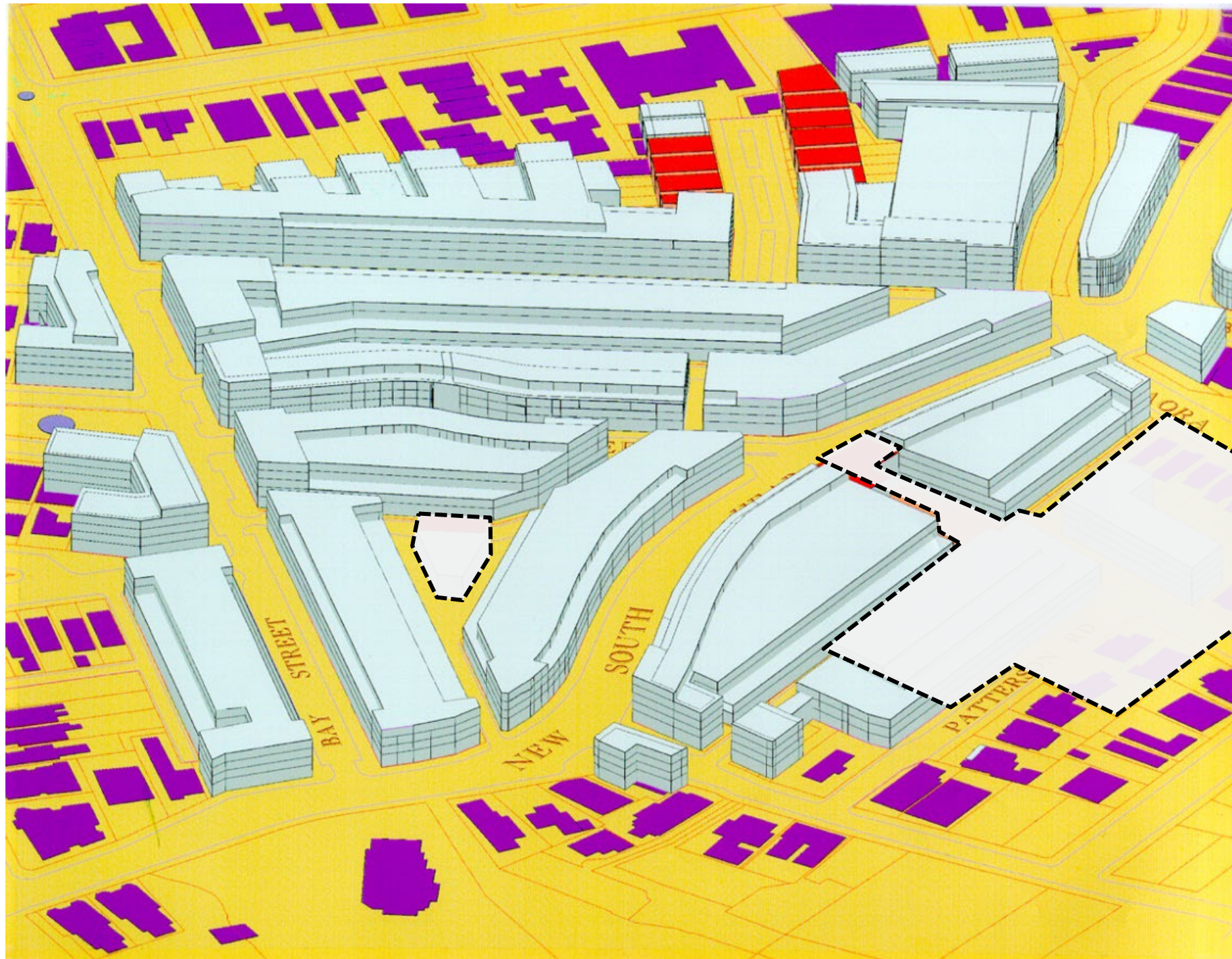
The building envelopes illustrate the permitted distribution of floor space in the centre. The FSR controls in Woollahra LEP 2014 limit the amount of floor space in the centre.

Note: This 3D view does not illustrate building envelopes as described in Appendix 2 Kiaora Lands.





D5.5.13 View 2: 3D view of building envelopes



View north along Bay Street

The building envelopes illustrate the permitted distribution of floor space in the centre. The FSR controls in Woollahra LEP 2014 limit the amount of floor space in the centre.

Note: This 3D view does not illustrate building envelopes as described in Appendix 2 Kiaora Lands.



---

## D5.6 Development controls

### D5.6.1 Format

---

This section contains the development controls for building and site elements in the Double Bay Centre. It provides further explanation of the Section D5.5 Built Form Envelopes: Control Drawings, and introduces additional controls not described in these drawings.

The following format is used:

#### Introduction

For most controls there is an introduction which explains the need and importance of including that particular element.

#### Objectives

The objectives define Council's intention. They relate to the aims and objectives in Section D5.3 Urban structure, and the desired future character outlined in Section D5.4 Street character.

#### Controls

The controls establish the means of achieving the objectives. This section must be read in conjunction with the Built Form Envelopes: Control drawings that illustrate the site specific controls. Diagrams are incorporated with the development controls to assist interpretation.

Not all controls will be relevant to every development. The applicant must nominate and provide justification for any controls they consider irrelevant to their development.

If a development proposal departs from a relevant control the applicant must demonstrate how the development satisfies the underlying objectives of the control.

## D5.6.2 Use

---

The distinctive mix of small scale shops, boutiques, restaurants, cafes, hotels, commercial premises and the like in the Double Bay Centre creates a friendly street environment that caters for the daily needs of the centre's users and creates an attractive environment for visitors.

Continuous ground level retail frontage offers the benefits of safety, commercial activity and street life. The provision of mixed development can make a significant contribution to the local character, providing street surveillance and after hour activity in the centre.

Previously there was very little residential use within the Double Bay Centre. Development in the last 10 years has tended to be mixed use, with ground floor retail with residential above. Residential development is encouraged within the centre to:

- ▶ increase the areas activity and vibrancy at night;
- ▶ encourage the provision of a range of retail services, particularly food stores; and
- ▶ reduce the reliance on cars to access the centre.



**FIGURE 18** Building use

Retain the range and intensity of existing retail uses in Double Bay and increase the level of activity in the centre by increasing the residential component of mixed use development

### Objectives

- 01 Encourage upper storey residential development within the centre to enhance the cosmopolitan character of the Double Bay Centre.
- 02 Encourage mixed use development to reduce transport and travel requirements.
- 03 Encourage the continuation of retail and commercial uses at street level in the centre.
- 04 Encourage first floor retail and commercial use.
- 05 Encourage arcades and double fronted shops that provide through block connections for pedestrians.
- 06 Limit the width of retail frontage to preserve the small shop character of the centre.
- 07 Encourage multi-level dwellings on the upper storeys of development as a means of redeveloping small narrow allotments.

- O8 Encourage activities which do not have unacceptable noise or other environmental impacts.
- O9 Ensure that buildings are designed and constructed to minimise noise and other impacts on building occupants and adjoining properties.



**FIGURE 19** Reinforce existing small lot development prevalent in the centre

Site amalgamation is particularly discouraged on these lots.

Where small lots (lots that are less than 6m wide and/or less than 30m deep) are amalgamated, the façade of the new buildings should be articulated and modulated to reflect the historic subdivision pattern.

### Controls

- C1 Design for a mix of uses within buildings.
- C2 Design durable and adaptable buildings, spaces and places.
- C3 Design for retail, commercial and community uses at ground and first floor levels. Consider design solutions that promote retail, commercial use at first floor level such as galleried arcades.
- C4 Access to residential uses should not occupy more than 20% of the ground floor frontage.
- C5 The maximum retail frontage at street level for individual premises identified on the diagram above must correspond with current lot widths. Other lots must not exceed 15m for each street frontage.
- C6 The architectural resolution of buildings on amalgamated small lots identified in Figure 19 must express existing lot widths.

## D5.6.3 Urban character

### 5.6.3.1 Building envelopes

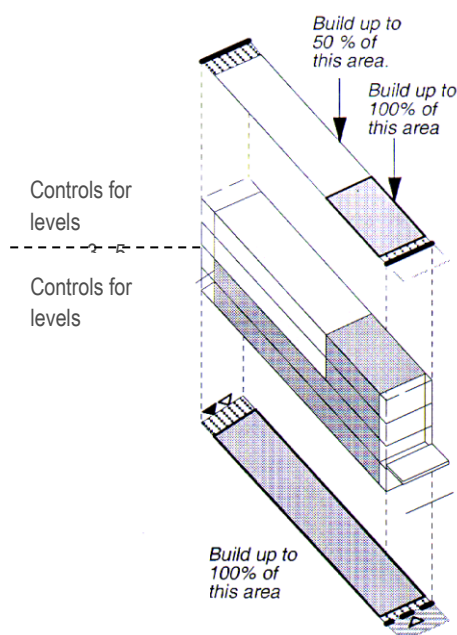
Building envelopes illustrate the limits of permissible building height, depth and location and are described on the control drawings, Section 5.5.5–5.5.11. The envelopes allow development that maintains the environmental amenity of buildings and the public domain with regard to building bulk, overshadowing, access to natural light and ventilation and views.

The building envelopes have been developed to foster a mix of uses in the centre, and to promote built form not reliant on artificial lighting, heating and ventilation. The deep ground and first floor building envelopes are suitable for retail and commercial uses, while the depths of envelopes for levels 3-5 are suitable for residential uses. The depth of residential buildings promoted in this chapter is based on the guidelines contained in the Residential Flat Design Code.

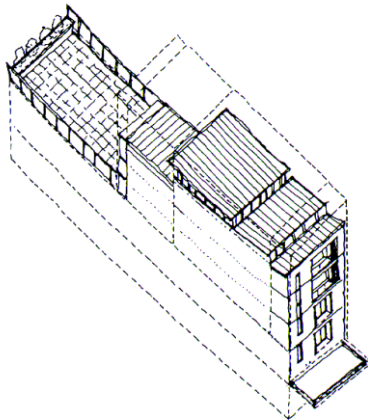
The building envelopes have been considered in conjunction with FSR. The FSR controls in Woollahra LEP 2014 limit the amount of floor space in the centre. The building envelopes illustrate the permitted distribution of floor space in the centre. The permissible floor space for each site (determined by FSR) is generally 80% of the theoretical floor space achievable within the building envelopes.

Uniform FSR facilitates development equity between sites; the envelopes allow flexibility in the ways the built form will be realised including the provision of arcades and through-site links.

Car parking above ground is not encouraged. If car parking is proposed at or above ground level (i.e. within the building envelope) the development may not achieve its maximum permissible floor space, and Council will not support a larger building envelope to provide for additional floor space.



**FIGURE 20** 3-dimensional controls  
Highlighting the building envelopes.



**FIGURE 21** Building envelope

Potential architectural resolution within 100% and 50% building envelopes.

### Objectives

- O1 Development should contribute to the desired future character of streetscapes with appropriate and consistent building forms.
- O2 Encourage courtyards and light wells at ground and first floor level of deep blocks to allow natural lighting and ventilation.
- O3 Enable the provision of through-site links and arcades.
- O4 Encourage a variety of interior volumes, i.e. split levels, double height spaces and arcades.

### Controls

- C1 Development must occur within the building envelopes shown on the Built Form Envelopes: Control Drawings, Section 5.5.5–5.5.11.
- C2 To create built form which is not reliant on artificial heating and cooling:
  - a) habitable rooms should generally achieve a minimum floor to ceiling height of 2.7m; and
  - b) level 3-5 building depth is limited to 15.6m including the articulation zones. When this is difficult to achieve in the residential component of a development, Council will consider variations to the overall building depth providing a minimum 80% of dwellings have windows that can be opened and/or doors in walls with differing orientations, to facilitate cross ventilation.
- C3 Deep building footprints are permitted at the ground and first floor only.
- C4 Building forms allow for:
  - a) natural day lighting and ventilation; and
  - b) privacy between dwellings or commercial premises.



### 5.6.3.2 Height

The permissible height of development in the Double Bay Centre is set in Woollahra LEP 2014. The control drawings in Section 5.5.5–5.5.11 illustrate the desired number of storeys for each part of the centre.

Building height has been determined by the need to preserve a pedestrian scale in the centre. Factors which play a role in achieving an appropriate scale relate to the width, orientation and character of streets and lanes. The envelopes generally establish three to four storey building heights along streets, and two storey building heights along lanes. Building above this height is required to be setback from the street or lane boundary to preserve amenity in the public domain.

Short Street, Kiaora Lane and Knox Lane have the potential to be more like little streets than lanes being wider than other lanes in the centre, and may include four storey buildings along the lane frontage interspersed with two storey buildings, provided that at least 50% of lane frontage is two storeys or less.

### Objectives

- 01 Encourage buildings to achieve the heights along street and lane frontages described by the control drawings.
- 02 Provide floor to floor heights that provide amenity to building users and allow adaptable reuse of levels.

### Controls

- C1 To reinforce the built definition of streets, buildings should be well designed and achieve the maximum prescribed height along the primary street frontage.
- C2 To achieve a variety of roof forms the floor level of the uppermost habitable storey must be at least 3.5m below the maximum permissible building height.
- C3 The building (including lift tower machinery plant rooms and storage space) must be contained within the envelope height, with the following exclusions: chimneys, flues, masts, flagpoles communication devices, satellite dishes and antennae.
- C4 The minimum floor to floor heights for the Double Bay Centre comply with the table below.

Level	Use	Height
Ground floor	Retail <sup>1</sup>	4m
Levels 2-5	Commercial office	3.4m
Levels 2-5	Residential	3.1m

<sup>1</sup> Applicants may choose to vary storey height using 3.7m height for ground floor and Level 2 to create double storey spaces with a combined floor to floor height of 7.4m.

### 5.6.3.3 Building articulation

Building articulation refers to the three dimensional modelling of a building facade. The control drawings indicate the area for building articulation on a site-by-site basis (see Section 5.5.5–5.5.11).

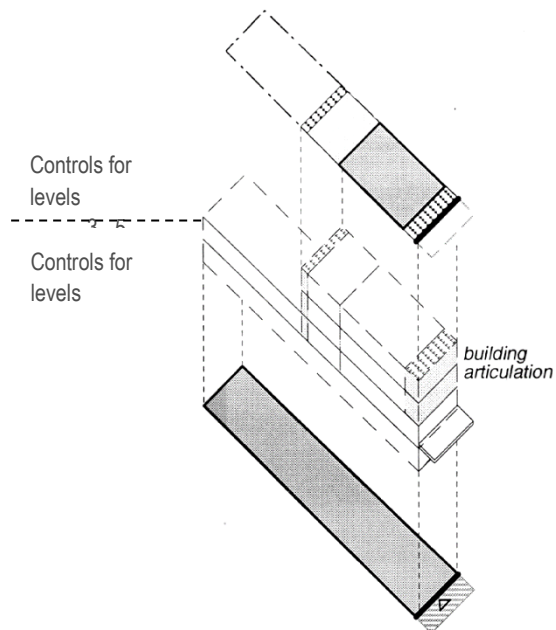
Building articulation along the street or laneway frontage establishes the relationship between a building and the street, through the use of entry porches, loggias, balconies, bay windows and the like. Building facades can be articulated to create a strong street address, and enrich the character of the street or laneway. Existing buildings along the south-eastern side of Bay Street in particular demonstrate a range of transition areas and modelled facades.

Building articulation should respond to environmental conditions such as orientation, noise, breezes, privacy and views, through the use of appropriate sun shading devices, noise barriers, privacy screens, and the careful location of balconies, terraces and loggias.

The street façade articulation zone shown on the control diagrams may be occupied by two types of space:

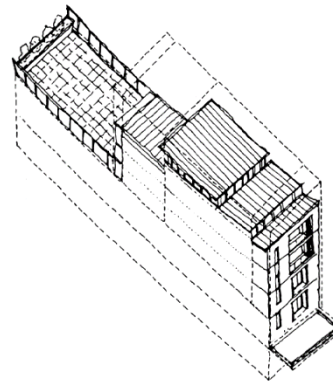
- ▶ External:
  - open balconies
  - void not occupied by built form
  - recessed balconies counted in proportion to the amount of the façade they are open to.
- ▶ Internal:
  - habitable rooms
  - bay windows
  - enclosed balconies
  - wintergardens.

**FIGURE 22** 3-dimensional controls  
Highlighting the area for building articulation



**FIGURE 23** Building articulation

The written controls nominate percentages of the building articulation zone to be “external space or internal space”. These include loggias, balconies, terraces, open stairs and walkways, and the like and must be wholly contained within the envelope.



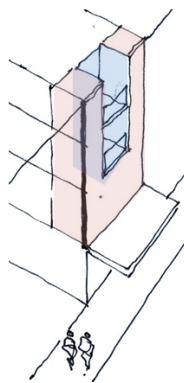
## Objectives

- O1 Promote buildings of articulated design and massing, with building facades that contribute to the character of the street, and provide useable external spaces.
- O2 Use building articulation to:
  - a) generate high quality architectural resolution;
  - b) provide private open space which addresses and overlooks streets and lanes;
  - c) provide environmental amenity such as noise reduction and visual privacy through building articulation;
  - d) provide thermal amenity within buildings such as screening and balconies for summer sunshading and maximising solar access in winter, appropriately scaled to their use and context; and
  - e) encourage activity such as outdoor eating along street edges, to help animate the street.

**Controls**

- C1 The following percentages of internal and external space should be incorporated with the composition of the building to achieve high quality architectural resolution at the street or laneway frontage.
- C2 The mix of internal and external space for articulation areas shown on the control drawings that do not front a street or laneway may be determined by the applicant.

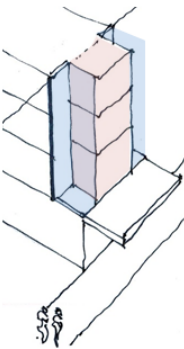
Note: The use of a palette of articulation elements is recommended to achieve high quality architectural resolution.



**FIGURE 24** New South Head Road

On levels 2-5 up to 80% the street façade articulation zone may be internal space with the balance of the area used for external space.

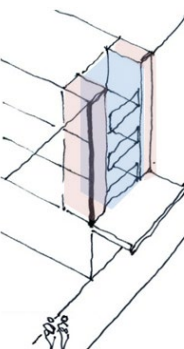
On the ground floor of the south side of New South Head Road up to 40% of the street façade articulation zone should be internal space. The remaining 60% must be level with the footpath and should be part of the building or shop entry.



**FIGURE 25** Bay Street South and south side of Cross Street

On levels 2-5 up to 40% of the street façade articulation zone must be occupied with either or both internal or external space.

On the ground floor up to 100% of the street façade articulation zone can be internal space.



**FIGURE 26** All other areas

On levels 2-5 up to 40% the street façade articulation zone can be occupied with internal space.

On the ground floor up to 100% of the street façade articulation zone can be internal space.

---

### 5.6.3.4 Setbacks

Setbacks at street level can increase pedestrian amenity. Street level setbacks are most successful when they establish continuous and consistent building alignments.

Setbacks on upper levels allow solar access to streets, and establish an appropriate relationship between building height and street width.

The controls include a continuous or discontinuous building line that requires development to meet this alignment to reinforce or create a particular street character. For example the building lines and articulation zones will create lightly articulated buildings (New South Head Road) or highly articulated buildings with recessed balconies (Knox Street).

#### Objectives

- O1 Encourage consistent building lines to provide coherent streetscapes.
- O2 Introduce new setbacks at street level in selected laneways to improve pedestrian amenity.
- O3 Where indicated provide street setbacks to the upper level of development to permit mid-winter sunlight.

#### Controls

- C1 Building alignment must comply with the building lines shown on the Built Form Envelopes: Control Drawings, Section 5.5.5–5.5.11.
- C2 Front setbacks are identified as building lines on the control drawings, Section 5.5.5–5.5.11. Front setbacks must define a coherent alignment to the public domain.
- C3 Side setbacks must:
  - a) protect privacy to adjoining buildings; and
  - b) protect access to natural light and ventilation to adjoining buildings and residential areas.
- C4 Rear setbacks must:
  - a) where required, accommodate vehicle access to the rear of lots, provide consolidated deep soil landscaped areas where blocks adjoin residential areas; and
  - b) protect privacy and facilitate solar access to adjoining buildings and gardens.
- C5 Upper level street setbacks are identified on the control drawings, Section 5.5.5–5.5.11. Building articulation excluding floor area elements may be used between the setback line and the street boundary. Refer to Section 5.6.3.3 Building articulation.

**5.6.3.5 Corner buildings**

Corner buildings are highly visible and provide the opportunity for notable design solutions. Strong corner buildings can provide valuable street definition. Existing buildings within the study area that provide this definition include the buildings on the corners of Knox Street and New South Head Road, and Coopers Corner on the intersection of Bellevue Road and New South Head Road. Due to the distinctive street geometry strong corner buildings can play an important urban design role in the Double Bay Centre.

The corner lots that may be granted additional floor space are identified in clause 4.4A of Woollahra LEP 2014. Figure 27 is an example of a strong existing corner building. Figure 28 is an example of existing corner building that lacks scale. New development at this corner intersection should take a form similar to that illustrated in Figure 29.



**FIGURE 27** 376 New South Head Road  
Located on the corner of Knox Street and New South Head Road, this building demonstrates good corner address



**FIGURE 28** Existing corner buildings at the five way intersection near Cross Street currently lack the scale to adequately address this large space



**FIGURE 29** The five way intersection could become a distinctive entry to the Double Bay Centre as illustrated, with buildings that strongly address the intersection.

Where street geometries permit entries and windows should address the corner such as shown in this example

## Objectives

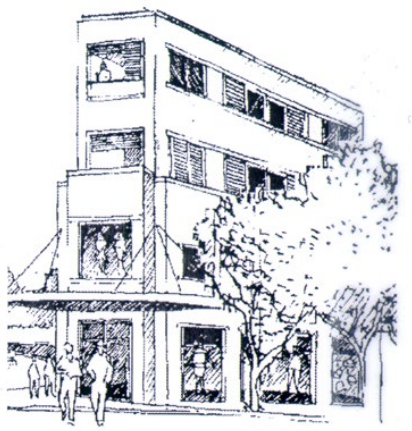
- O1 Encourage building massing and articulation that creates strong corner buildings.
- O2 To outline the desired future character of corner sites where applicants seek to use an FSR of 3:1 per clause 4.4A of Woollahra LEP 2014.

## Controls

- C1 Consider the design of corner buildings in relation to street geometry, topography, sight lines and the design of skyline elements.
- C2 Distribute building massing, such as height, to enhance the corner.
- C3 Corner buildings are encouraged to achieve the maximum prescribed height along the street edge.
- C4 Developments on sites listed below that comply with the development controls may be eligible for an FSR of 3:1 (refer to the floor space provisions in clause 4.4A of Woollahra LEP 2014):
  - a) Bay Street - 26, 28, 30/36, 38, 43, 45A, 49, 55;
  - b) Cross Street - 53; and
  - c) New South Head Road - 298, 302, 304, 304A, 306/310, 312/314, 357/359, 365, 376/382, 408/410, 412, 414/420, 422/424, 465/467, 469/473.

### 5.6.3.6 Architectural resolution

Buildings in the Double Bay Centre represent a mixture of 20th century buildings that are of variable style and quality. High quality architectural resolution will improve living and working environments, contribute toward an improved built definition of the public domain, and can help to define a local identity.



**FIGURE 30** Architectural resolution

The masonry elements of a building can give it coherence



**FIGURE 31** An existing building at Knox Lane showing an articulated upper level and roof



**FIGURE 32** Architectural resolution  
The building wall is set back from the street and is modelled with attached building elements



**FIGURE 33** Twenty One Espresso demonstrates fine grained building form in Knox Street



---

## Objectives

- O1 Promote high quality architectural design throughout the Double Bay Centre to create a desirable and memorable environment.
- O2 Encourage coherent streetscapes based on common design principles for each street and lane.
- O3 Minimise the negative impacts of glare and reflectivity on adjoining public and private properties.
- O4 To ensure that development enhances the visual quality and identity of the centre through well considered design, high quality materials and facade colours that do not dominate the street.
- O5 The colour of the building facade is not intrusive or unreasonably dominant within the streetscape, and is compatible with the character of the centre.

## Controls

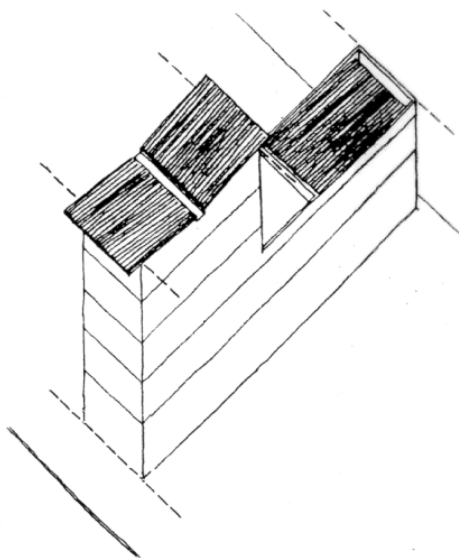
- C1 Provide a clear street address to each building. Clearly define pedestrian entries.
  - C2 Provide predominantly glazed shopfronts to ground floor retail areas. Roller shutters to shopfronts are not permitted.
  - C3 New buildings and facades do not result in glare that causes discomfort or threatens safety of pedestrians or drivers.  
  
Note: A reflectivity report that analyses the potential glare from the proposed new development on pedestrians or motorists may be required.
  - C4 New buildings and facades must minimise the impact of glare and reflectivity on adjoining land.
  - C5 Materials must be compatible with the existing urban context, such as red face brick and rendered masonry, in street facade design.
  - C6 The external painting of a building in bright colours, corporate colours or fluorescent colours should be avoided.
  - C7 Any individual business branding and identity in external painting and colour schemes is to be subordinate to the main colour schemes in the street. (Also refer to the signage controls in Part E7 of the DCP, Section 7.2.2 When external painting of a building constitutes a wall sign.)
  - C8 The design of window and balcony openings must account for streetscape, heritage items, privacy, orientation and outlook.
  - C9 Richly articulate facades to express the different levels of the building and/or its functions.
  - C10 Blank party walls are to be avoided.
  - C11 Design commercial space to permit maximum flexibility for future uses.
-

- C12 All rooms above ground floor level, including kitchens and bathrooms, are to have windows or skylights.
- C13 The residential component of buildings must contain a variety of apartment sizes and layouts.
- C14 Vehicular entries must be discrete and minimise conflicts with pedestrians.

**5.6.3.7 Roof design**

The Double Bay Centre is located at the base of a large natural amphitheatre. As a result, building roof forms are highly visible, often forming the foreground to a harbour view, and require a well-considered design response.

Existing roof forms vary with building type and architectural style and include a range of hip roofs, gables, flat roofs, parapets and roof decks. A predominance of buildings with parapets contributes to the urban quality of New South Head Road.



**FIGURE 34** Roof design

A variety of roof types are possible in the Double Bay Centre. Roof forms need to be articulated to control the apparent scale of the building when viewed from above

**Objectives**

- O1 Encourage highly articulated roof design that responds to building orientation and the location and character of Double Bay.
- O2 Roof designs should create distinctive building silhouettes.
- O3 Encourage a variety of articulated roof forms for the Double Bay Centre such as hips, gables, flat roofs, parapets and roof decks.
- O4 Discourage the provision of air conditioning plant and equipment on the roofs of buildings to minimise visual impact of these services.

---

## Controls

- C1 Roof design must form a coherent part of the whole building and be articulated.
- C2 A variety of roofs are permitted, including gabled and hipped roofs with habitable attic spaces, flat roofs and roof decks.
- C3 Buildings along New South Head Road should provide a parapet.
- C4 The profile and silhouette of parapets, eaves and roof top elements must be considered in roof design.
- C5 Roof design must minimise building bulk and overshadowing.
- C6 Air conditioning plant and equipment must be concealed from the exterior and be within the building. When roof plant is proposed it must be screened from neighbours and be integrated with the design of the roof and the composition of the building.

### ***5.6.3.8 Heritage items and character buildings***

Woollahra Council supports the conservation of the rich mixture of buildings, parks and places of special significance within the Municipality. Woollahra LEP 2014 contains various controls relating to the conservation of heritage items and areas. Woollahra LEP 2014 also contains incentives for developments that include the conservation of heritage items.

In the Double Bay Centre Woollahra LEP 2014 identifies heritage items and a conservation area. For example, the Golden Sheaf Hotel and the Transvaal Avenue Heritage Conservation Area which comprises single storey Federation semi-detached cottages. Development proposals must comply with the heritage provisions in Woollahra LEP 2014.

In addition, a number of buildings have been identified as character buildings. These have high streetscape value because of their strong architectural character and the way in which they address the street:

- ▶ Coopers Corner, 475-479 New South Head Road;
- ▶ Twenty One, 21-25 Knox Street;
- ▶ 45A Bay Street;
- ▶ 24-26 Bay Street;
- ▶ 14 Bay Street;
- ▶ 37 Bay Street;
- ▶ 35 Bay Street;
- ▶ 29-33 Bay Street;
- ▶ 9 Bay Street;
- ▶ 11 Bay Street;
- ▶ 13 Bay Street; and
- ▶ 15 Bay Street.



**FIGURE 35**  
Character buildings



**FIGURE 36**  
Golden Sheaf Hotel  
The Golden Sheaf Hotel is a heritage listed building. It demonstrates the contribution buildings constructed to the street boundary can make to the public spaces they address

---

## Objectives

- O1 Protect and enhance heritage items and conservation areas.
- O2 Encourage the sensitive adaptation or reuse of buildings that contribute to the spatial definition of the urban spaces they address.

## Controls

- C1 All new developments and works to existing developments are to be designed to be compatible with the significance of listed heritage items, conservation areas and nominated character buildings.
- C2 For development within the Transvaal Avenue Heritage Conservation Area refer to Appendix 1.
- C3 Development to a character building is to respect the building and complement and enhance the key characteristics of the building including:
  - a) street edge definition;
  - b) its material, detailing and character;
  - c) its holistic building character related to articulation, massing, and patterns and distribution of wall opening.
- C4 Variations to the building envelope will only be considered where it can be demonstrated that the variations support the sensitive adaptive reuse of heritage items relating to the building's massing.
- C5 Where a character building is proposed to be replaced, the architectural quality and streetscape contribution of the proposed building must be at least equal to the quality of the building's material, character and detailing.
- C6 Modifications to character buildings must retain or enhance the architectural streetscape value of the existing building.

### D5.6.4 Relationship to public domain

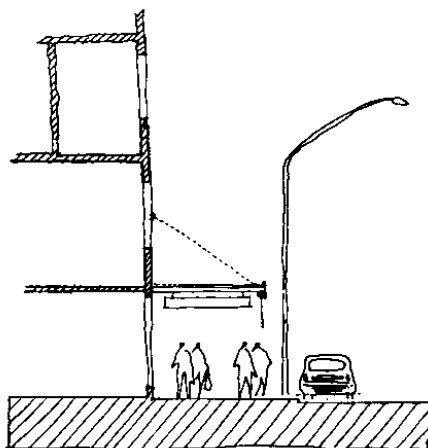
The success of commercial centres is dependent on street edge activity. Street activation requires a safe, cohesive and attractive public domain. This section establishes objectives and controls for the street frontage elements of built form such as awnings, colonnades, arcades, walkways, courtyards, public art, outdoor eating and address to laneways.

#### 5.6.4.1 Awnings

Continuous awnings contribute to the street character of retail centres and provide weather protection for pedestrians. There are currently continuous awnings on both sides of New South Head Road and along a considerable part of the southern side of Knox Street. Awnings elsewhere in the centre are more varied and less continuous, and are often used to highlight building entrances.



**FIGURE 37** Continuous awnings  
Continuous awnings are required in these locations



**FIGURE 38** Awning design  
Suspended steel box section type with a minimum soffit height of 3.2m

---

## Objectives

- O1 Retain and supplement the existing awnings in the designated areas shown in the control drawings.
- O2 Encourage consistent awning design throughout the centre.

## Controls

- C1 Development must provide continuous awnings to street frontages as indicated on the control drawings, Section 5.5.5-5.5.11.
- C2 Awning cover should be within 5° of horizontal, with a minimum soffit height of 3.2m.
- C3 The awning design should provide protection from sun and rain and be integrated with the building's architectural resolution.
- C4 Where no awnings are indicated on the control drawings, Section 5.5.5-5.5.11—the building entrances must have generous cover.
- C5 Canvas blinds along the outer edge of awnings may be used to provide sun shading to the east and west facades. No advertising is permitted, however business identification signage may be acceptable.
- C6 Under awning lighting may be recessed into the soffit of the awning or wall mounted on the building.

### 5.6.4.2 Colonnades

A colonnade is created when a building is set back from the boundary at street level with vertical supports such as columns supporting the building directly above. A continuous colonnade improves pedestrian amenity by extending the footpath at ground floor level, and providing shelter. Consistently spaced colonnade posts establish a pedestrian related rhythm.

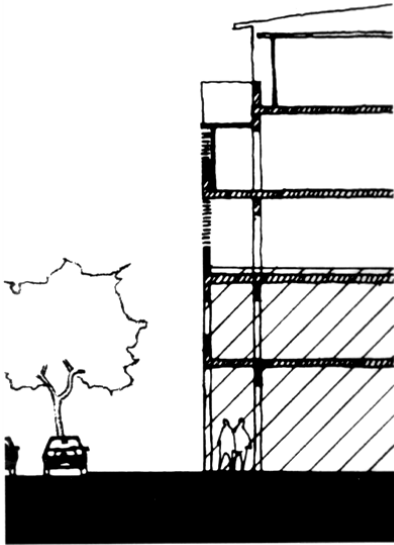
Colonnades are most successful when they are continuous and consistent. Guilfoyle Park on Bay Street makes a substantial contribution to the ambience of the centre. This quality could be

enhanced through appropriate built form which interprets the park's civic importance in its address to the park.



**FIGURE 39** Colonnades

Colonnades are required in these locations



**FIGURE 40** Colonnades on Bay Street articulate the importance of Double Bay's main public place – Guilfoyle Park



### Objectives

- O1 Encourage colonnaded buildings in Bay Street, between Cross Street and Short Street, which interpret Guilfoyle Park's civic importance and establishes a spatial relationship between the park and the buildings which address it.

### Controls

- C1 Colonnades should be provided at ground floor level to street frontages as indicated on the control drawings, Section 5.5.5–5.5.11 and the street sections.
- C2 Colonnade width must be 2.4m.
- C3 Colonnades must have a minimum soffit height of 3.6m.
- C4 Colonnade supports must be integrated with the building design and adjoining colonnades if they exist, and not unduly impact upon pedestrian thoroughfare, or obscure ground floor activity from the street.
- C5 Colonnade design must respond to the articulation of adjacent buildings, and the broader desired future character.
- C6 Colonnades must be level with the street paving, and be paved in accordance with the standard Double Bay pavers (refer to the Public Domain Improvements Plan 1999 and Council's Technical Services Division for advice).

### 5.6.4.3 Arcades, walkways and courtyards

One of the defining characteristics of Double Bay is its honeycomb of external walkways and arcades. Good quality arcades have active retail frontages, and contribute to a vibrant pedestrian shopping environment. The provision of good quality arcades and walkways with a light and airy character is encouraged.



**FIGURE 41** Goldman Lane

This walkway off Knox Street has retail frontages on both sides and a light airy character, which is promoted in this chapter



**FIGURE 42** Locations of existing arcades and through site links

When redeveloping a site, existing arcades or through site links must be retained

- arcade
- - - - - walkway



**FIGURE 43** Desirable through block connections

Arcades are permitted throughout the centre except on corner lots. This drawing shows the most desirable through block connections. Consider the proximity of nearby arcades when providing a new arcaded connection

- arcade
- - - - - walkway

---

### Objectives

- O1 Encourage new arcades and walkways that provide:
  - a) public access across private land; and
  - b) connections between streets and other parts of the public domain.
- O2 Create arcades with active retail frontages.
- O3 Encourage arcades that are supplemented with outdoor areas such as courtyards or outdoor rooms.
- O4 To provide suitable amenity within arcades.

### Controls

- C1 All existing arcades and walkways must be retained or replaced when a site is redeveloped.
- C2 Arcades must be mostly naturally lit and ventilated.
- C3 External walkways must be paved in accordance with the standard Double Bay pavers (refer to the Public Domain Improvements Plan 1999 and Council's Technical Services Division for advice).
- C4 The proportions and character of arcades should reflect their importance in expanding the public domain and their location in the centre.
- C5 Arcades must have a minimum:
  - a) width of 3m; and
  - b) ceiling height of 3.6m.
- C6 Arcades must, to the extent possible, provide a clear sightline from one end to the other for surveillance and accessibility.

#### 5.6.4.4 Public art

Public art in developments can enhance the experience of the occupants and contribute to a sense of place.

### Objectives

- O1 To require the provision of public art in significant or large-scale developments.
  - O2 To integrate the public art so it is a cohesive part of the building design, interior or landscaping of the development.
  - O3 To design and locate the public art so that the aesthetics and amenity of the art can be appreciated by people within and outside the development.
  - O4 To enhance the experience of the occupants of the development and their relationship with the development through public art.
-

- O5 To use public art to facilitate a connectedness between the development and the public domain.

**Controls**

- C1 Development with a capital investment value of \$15M or more includes public art.
- C2 The public art is installed on the development site or in the immediate vicinity of the site.
- C3 The public art is located so that it is not unreasonably inaccessible or obscured by a building element which makes it impossible to see in full by the building occupants and the general public.
- C4 The public art is prepared and undertaken in accordance with the Woollahra Public Art Guidelines for Developers.

**5.6.4.5 Outdoor eating**

The Double Bay Centre is a desirable location for the provision of outdoor eating facilities due to the temperate climate, favourable orientation, leafy quality of streets and active street frontage.

Outdoor eating facilities have the potential to add to the liveliness of streets and activate other outdoor places.



**FIGURE 44** Outdoor eating  
Outdoor eating establishments can provide lively street activity in suitable locations

**Objectives**

- O1 Encourage outdoor eating establishments where they provide a pleasant outdoor eating environment with minimal disturbance to pedestrian circulation and where they comply with Councils associated codes and policies.

## Controls

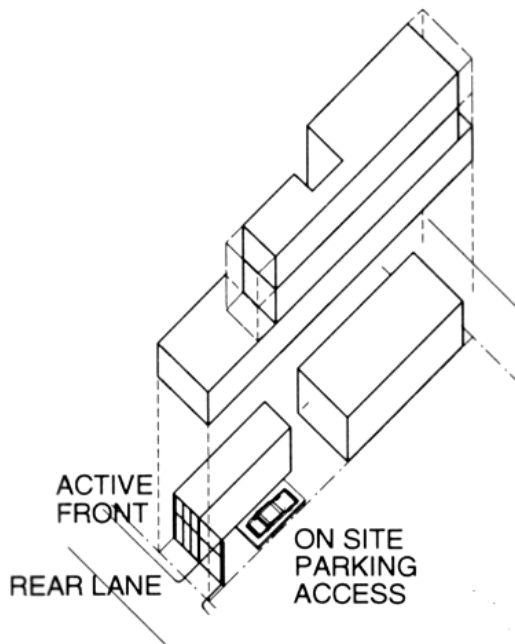
C1 Development is to comply with Council's policy for footway restaurants.

### 5.6.4.6 Ground floor active lane frontage

Active street frontage is characterised by liveliness and activity associated with pedestrian activity, building entrances, shop entries and attractive shop displays.

The Double Bay Centre benefits greatly from a network of lanes that work in conjunction with arcades to provide pedestrian connections. As active pedestrian environments, the laneways have unrealised potential to intensify retail activity in the centre.

Note: An active frontage is defined as one or a combination of the following: entrance to retail, retail shopfront, entrance to residential/commercial above, cafe or restaurant if accompanied by an entry.



**FIGURE 45** Active retail frontage

Consider using a car hoist with basement parking as a means of maximising active retail frontage. Lane address should incorporate active frontage and minimise the impact of access to on-site parking

## Objectives

- O1 Provide an active frontage at the ground level of buildings facing lanes to add to the vitality, and usefulness of both lane and building.
- O2 Coordinate the provision of vehicular and service access to maximise ground floor activity along lanes.
- O3 Improve the pedestrian amenity of lanes to encourage a wide range of uses.

- O4 Improve safety and security by providing active shopfronts to improve general lane surveillance.
- O5 Discourage off-street loading facilities in laneways if on-street loading bays are available.

### Controls

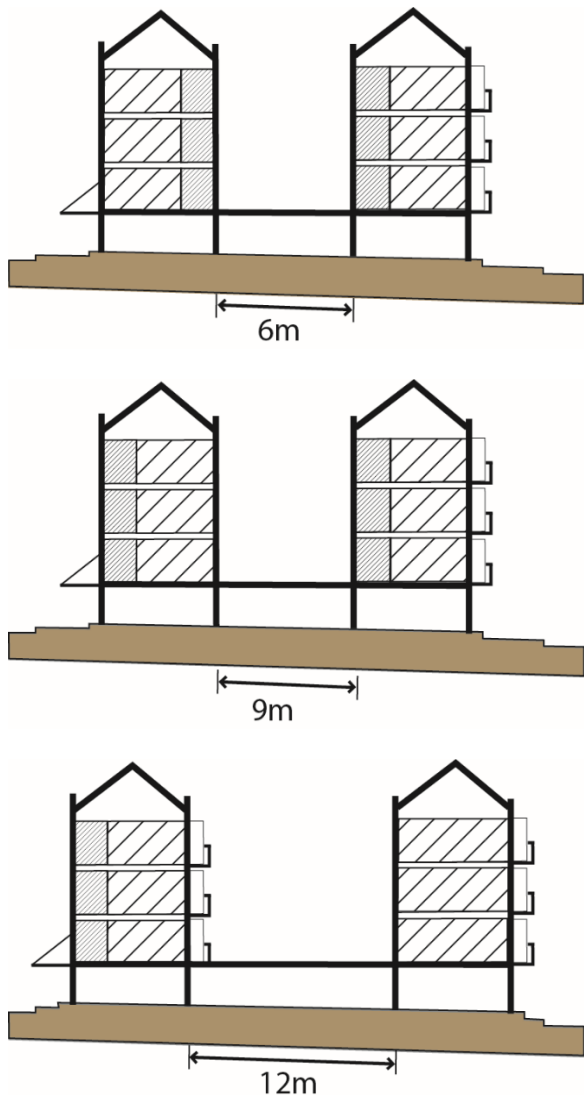
- C1 A minimum of 75% active frontage to lanes, measured as a linear ratio across the width of a lot, is generally required. Development on narrow lots may vary this requirement if applicants demonstrate that the vitality and usefulness of the lot frontage is maximised.
- C2 Vehicle access points and building entrances must be separate and clearly defined to avoid pedestrian and vehicular conflicts.
- C3 Ensure service areas are unobtrusive and have minimal lane presence. Preferably orientate service areas within the building envelope, perpendicular to lane frontage.
- C4 Services, such as garbage areas and electrical substations, should not dominate the laneway frontage or otherwise unreasonably reduce the opportunity to establish an active frontage to the laneway. Services should generally be located within the building envelope and integrated with the building design.
- C5 Retail, restaurant, cafe shopfronts should be glazed and able to be opened and/or provide through shop/lot visibility.

## D5.6.5 Amenity

### 5.6.5.1 Visual privacy

Visual privacy is an important consideration for residential development within the centre, and neighbours adjacent to the centre, as it is a major determinant of amenity.

**FIGURE 46** Recommended minimum separations between openings to achieve visual privacy



#### **Habitable room**

A room used for normal domestic activities that includes: a bedroom, living room, lounge room, music room, television room, dining room, sewing room, study, playroom, sunroom and kitchen.

#### **Non-habitable room**

A room of a specialised service nature occupied neither frequently nor for extended periods, including a bathroom, laundry, water closet, food storage pantry, walk in wardrobe, corridor, hallway, lobby or clothes drying room.

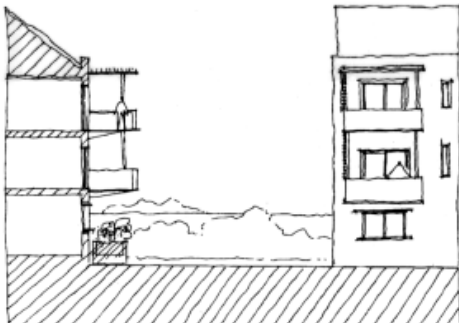
Source: AMCORD, 1995

### Objectives

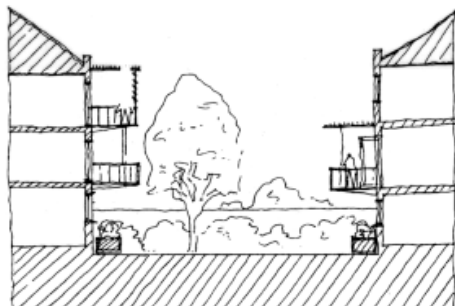
- O1 Ensure development protects the privacy of adjacent residential neighbours.
- O2 Ensure residential apartments and private open spaces have adequate visual privacy.

**Controls**

- C1 Orientate main living spaces, and their primary openings, to the street or rear garden to avoid overlooking between neighbouring properties. Living areas with primary openings facing the side boundary should be avoided.
- C2 Where openings face the side boundaries of properties, protect visual privacy between neighbouring dwellings by:
  - a) providing adequate distance between opposite windows - use the illustrations in this section as a guide;
  - b) offsetting facing windows of neighbouring dwellings; and
  - c) providing obscure glazing, screening or planting.
- C3 Protect privacy between dwellings proposed on a single development by adopting the recommended distance between openings illustrated in Figure 46. Alternatively use vegetation and balcony screening to protect privacy.
- C4 Use building articulation, particularly in required building articulation zones, to provide visual privacy between buildings and the public domain.
- C5 Primary door and window openings in residential living areas should be located towards the street and/or rear to protect privacy. Living areas with primary openings facing the side boundary should be avoided.



**FIGURE 47** Carefully locate balconies to protect privacy



**FIGURE 48** Vegetation and balcony screening must be used to enhance privacy when the recommended separations are not able to be achieved.

Source: AMCORD, 1995



### 5.6.5.2 Acoustic privacy

The Double Bay Centre is a vibrant place that contains a range of uses however, sometimes there can be tension between the business activities and residential amenity particularly when there is an active night-time economy.

Acoustic privacy is an important consideration in relation to the residential component of the centre, and neighbours adjacent to the centre, because it is a major determinant of amenity.

#### Objectives

- O1 Ensure adequate acoustic privacy to residential apartments and private open spaces in the centre.
- O2 Protect the acoustic privacy of residential neighbours adjacent to the centre.
- O3 Ensure the viability of housing, and greatly increase the amenity of dwellings, by minimising the impact of external noise sources.

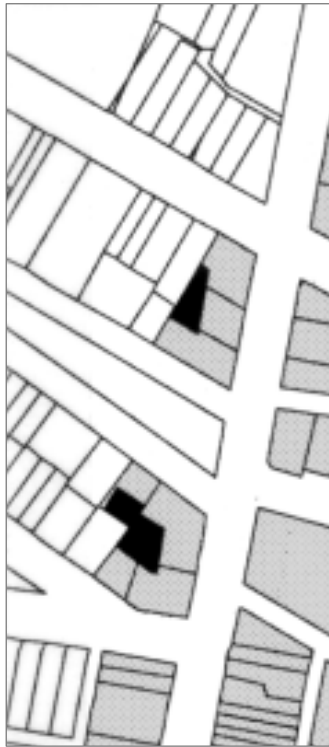
#### Controls

- C1 Building siting and layout, particularly with regard to the location of courtyards, terraces and balconies and the like, should minimise the transmission of noise to other buildings and private open space on the site and on adjacent land. The use of openings, screens and blade walls, and the choice of materials, should also be designed to minimise the transmission of noise. For example this may include:
  - a) using solid concrete/masonry balcony upstands to shield noise
  - b) using absorbent material to reduce sound bouncing off the balcony soffits.
- C2 Minimising the impact of external noise sources on dwellings near noise sources by:
  - a) addressing New South Head Road with recessed balconies, enclosed balconies, kitchens and/or living rooms;
  - b) locating bedrooms away from noise sources; and
  - c) designing and constructing dwellings with sound attenuation measures such as double glazed external doors and windows.
- C3 Bedrooms should be located away from noise sources such as goods delivery and early morning garbage collections.
- C4 Restaurants should be designed to minimise the impact of noise associated with late night operation on nearby residents.
- C5 Rear courtyards are only permitted for restaurant use if Council is satisfied that the hours of operation do not have an unreasonable impact on residential amenity.

Note: Council may require a noise impact assessment report to accompany a development application. Council will exercise its discretion when deciding if a noise assessment report is required. Examples of such circumstances include but are not limited to, development containing residential uses in close proximity to areas activated by the night time economy, or development containing residential uses located in close proximity to New South Head Road.

**5.6.5.3 Landscaped areas**

Private gardens at the rear of residential blocks adjoining the centre collectively create large scale open spaces. To ensure development immediately adjoining these blocks preserves and extends these open spaces a landscaped area requirement is included in the control drawings, Section 5.5.5–5.5.11. Landscaped areas may be private, communal or publicly accessible.



Bay Street and Guilfoyle Avenue

**FIGURE 49** Landscaped areas

Landscaped open space provides a transition between the commercial area and adjoining residential properties.



Manning Road

---

## Objectives

- O1 Ensure development immediately adjoining residential blocks continues the pattern of built form and open space established in the block.
- O2 Provide landscaped areas, typically in the centre of blocks, to preserve and extend established open spaces.
- O3 Provide landscaped areas that preserve neighbouring residences' access to day light and natural ventilation and provides visual privacy.
- O4 Mature trees and other planting is encouraged within landscaped areas to maintain Double Bay's existing leafy quality. Permeable surfaces are also encouraged to maximise the on-site infiltration of stormwater.

## Controls

- C1 Above ground development may not occur within the landscaped area shown on the control drawings, Section 5.5.5–5.5.11. 50% of the area designated as landscaped area must be a deep soil landscaped area.
- C2 Car parking should be located under the building footprint to maximise deep soil landscaped areas.
- C3 Plantings over underground structures should have sufficient soil depth to allow sustainable planting.

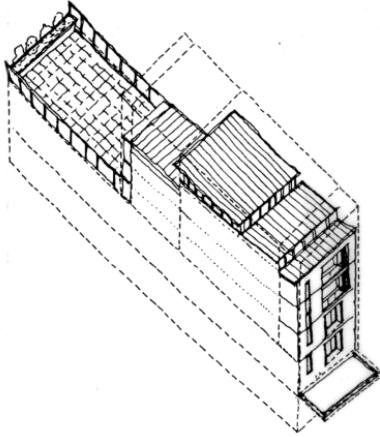
Note: A site-specific landscape specification is to be prepared for landscaping above underground structures. The specification should include considerations such as plant species, soil depth and drainage.

- C4 One large mature tree, planted in deep soil, is required for every 100m<sup>2</sup> of landscaped area.

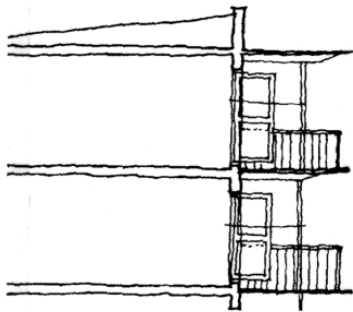
### 5.6.5.4 Private open space

Private open space includes ground floor garden areas and above ground open spaces such as terraces, loggias, balconies, or decks. The availability and accessibility of comfortable private

and communal outdoor living areas is a major determinant of the ability of occupants to enjoy living and working in the Double Bay Centre.



**FIGURE 50** Above ground open space  
Above ground open space may be created as a roof terrace



**FIGURE 51** Above ground open space  
Above ground open space may be created within the articulation zone and should utilise prevalent breezes



**FIGURE 52** Lightweight pergolas, sun screens and planters can enhance the quality of roof spaces, and provide privacy

## Objectives

- O1 Ensure every dwelling in the Double Bay Centre has direct access to private open space.
- O2 Encourage occupied roof areas with roof gardens behind parapets where private open space at ground level is not available.

## Controls

- C1 Provide at least one balcony, terrace, verandah, loggia, roof terrace or deck for each dwelling, within the area nominated for building articulation. This open space must be accessible from a principal living area.
- C2 The preferred depth of the required open space is 2.4m and the minimum permissible depth is 1.8m. The minimum area of private open space is determined by the dwelling size:

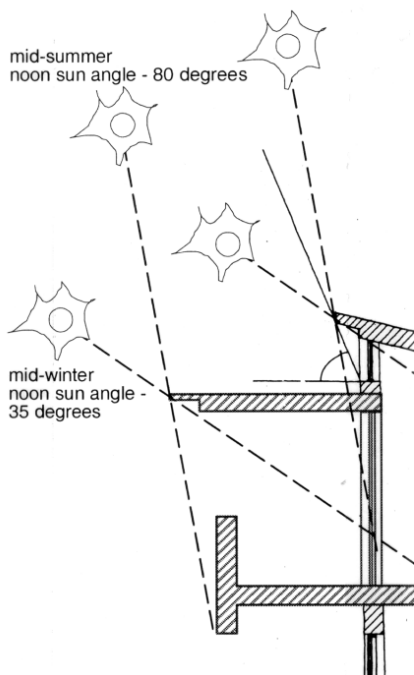
Dwelling size	Minimum required area of above ground open space
Small dwelling: less than 60m <sup>2</sup>	8m <sup>2</sup>
Medium dwelling: 60m <sup>2</sup> - 90m <sup>2</sup>	12m <sup>2</sup>
Large dwelling: more than 90m <sup>2</sup>	16m <sup>2</sup>

- C3 Roof terraces and balconies must be designed and orientated to protect the privacy of neighbours.
- C4 Lightweight pergolas, sunscreens, privacy screens and planters are permitted on roof terraces provided they do not increase the bulk of the building. These elements should not significantly affect the views available from adjoining properties, the immediate vicinity or on the nearby ridges.
- C5 The profile and silhouette of parapets, eaves and roof top elements must be considered in roof terrace design to provide an attractive building finish when viewed from the public and private domain.

## D5.6.6 Solar access and natural ventilation

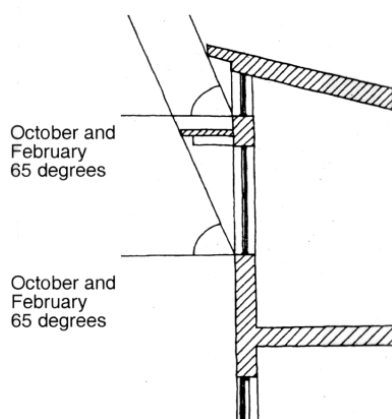
### 5.6.6.1 Solar access

Solar access is a major determinant of environmental comfort and residential amenity. Good passive solar design offers financial and environmental benefits, by reducing the need for artificial heating and cooling.



**FIGURE 53** Mid-winter and mid-summer solar angles for openings facing true north

The design of north facing balconies and rooms should aim to admit low angle winter sunlight, and exclude high angle summer sunlight



**FIGURE 54** Solar angles for windows facing true north

Eaves, screens and the size of openings for north facing balconies and rooms, should be designed with regard to the noon 17 October / 26 February sun angles to maximise winter sunlight penetration, and minimise summer sunlight penetration

Source: Energy Information Centre information sheet, May 1994

---

## Objectives

- O1 Minimise overshadowing of adjoining properties or publicly accessible spaces.
- O2 Building form, separation and plan layout should facilitate good solar access to internal and external living spaces, to maximise natural heating and cooling and minimise the use of artificial systems.

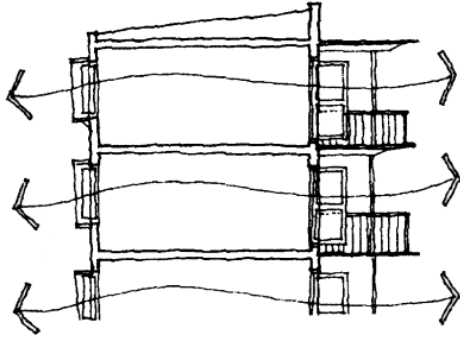
## Controls

- C1 Preserve solar access to Guilfoyle Park and the footpath on the south side of Knox Street, Cross Street, and New South Head Road between 12 noon and 2pm on 21 June.
- C2 Development should comply with the control drawings in Section D5.5 to ensure adequate solar access is provided to neighbouring properties.
- C3 Development which does not comply with the control drawings must maintain existing solar access to existing development for at least three hours between 9am and 3pm on 21 June to north facing windows of habitable rooms, and at least two hours to at least 50% of the private open space.
- C4 Access to sunlight should be achieved for a minimum period of three hours between 9am and 3pm on 21 June to windows of habitable rooms and two hours to private open space of new development.
- C5 Locate main living spaces including lounge, dining, kitchen and family rooms toward north where possible.
- C6 Skylights which provide the sole source of daylight and ventilation to habitable rooms are not permitted in residential or commercial development.

### 5.6.6.2 Cross ventilation

The design of buildings provides an opportunity to reduce long term energy consumption. Building envelopes in this plan promote thin cross section buildings which do not rely on artificial

lighting and ventilation. Building design for natural ventilation should capitalise on Double Bay’s harbour side location and on-shore breezes.



**FIGURE 55** Cross ventilation

Thin cross-section design achieves good cross ventilation and assists day lighting of rooms

### Objectives

- O1 All buildings should be designed to achieve natural ventilation.
- O2 Design buildings with naturally lit habitable rooms.

### Controls

- C1 The maximum building depth of development for levels 3-5 is 15.6m to achieve buildings that are substantially naturally lit and ventilated.
- C2 Encourage the provision of windows to all rooms, including kitchens and bathrooms, to facilitate natural light and ventilation. Avoid or minimise the reliance on mechanical ventilation or air conditioning.
- C3 Encourage building articulation, such as light wells and courtyards, that allows daylight into ground and first floor levels.
- C4 All dwellings in each development must have windows that can be opened and /or doors in walls with differing orientations, to facilitate cross ventilation by locating windows opposite each other. When this is difficult to achieve on non-rectangular lots with limited street address, at least 80% of dwellings within that development must comply.
- C5 Skylights that provide the sole source of daylight and ventilation to habitable rooms are not permitted.



### D5.6.7 Geotechnology and hydrogeology

---

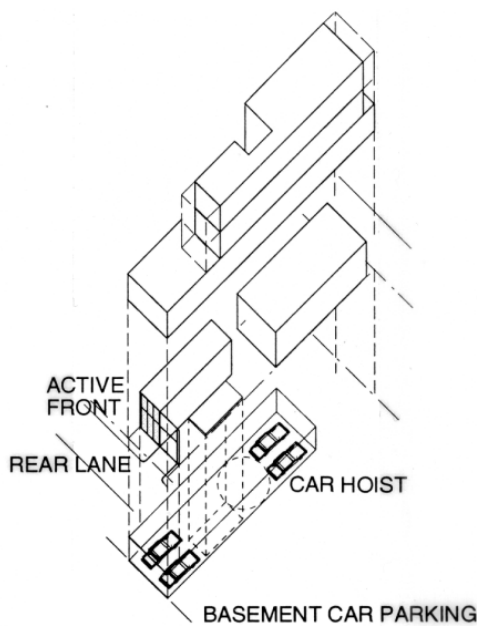
Repealed by Woollahra DCP 2015 (Amendment 18) on 6 December 2021.

Refer to Chapter E2 Stormwater and Flood Risk Management of Woollahra DCP 2015.

## D5.6.8 Parking and site facilities

### 5.6.8.1 On-site parking

The opportunity for on-site parking is restricted in many areas of the Double Bay Centre. The narrow width of some lots makes it impossible to accommodate more than two spaces on-site, and the level of the existing water table in the centre may make site excavation for underground parking difficult. This chapter aims to satisfy the parking demand likely to be generated by future development, whilst facilitating the redevelopment of narrow lots and discouraging over-reliance on cars.



**FIGURE 56** On-site parking

If on-site parking is provided consider using a car hoist and turntable to maximise the efficiency of basement parking

### Objectives

- 01 Ensure the impact of car parking on the site and streetscape is handled discretely.
- 02 Ensure the design of on-site car parking is safe and efficient, and integrated with the overall site and building design.
- 03 Maximise natural light and ventilation to parking areas where possible.
- 04 Encourage cooperative approaches to car parking provision between adjoining lots that are less than 6m wide and/or less than 30m deep.
- 05 Ensure underground car parking facilities do not collectively create a continuous barrier to subsurface water flow.

---

## Controls

- C1 Parking provision must comply with Part E of this DCP, Chapter E1 Parking and Access, except where detailed below.
- C2 Consolidated parking areas are preferred below ground level where possible and concentrated under building footprints to maximise the area for landscaping areas.
- C3 Basement parking should be naturally ventilated if possible.

### Notes:

Part E of this DCP, Chapter E1 Parking and Access provides the parking generation rates for the Double Bay Centre. In certain circumstances on-site parking is not required. See the Parking and Access chapter for details.

Major developments on the north-western side of New South Head Road are encouraged to provide spaces additional to their development requirements for public parking. This should be negotiated with Council during the pre-DA stage.

A cooperative approach to parking provision, where car parks may be amalgamated and share access and egress points, are encouraged between two or three lots that are less than 6m wide and/or less than 30m deep.

### 5.6.8.2 Vehicular access

The continuity of retail frontages is essential to the liveliness of the Double Bay Centre and its urban character. Vehicular crossings interrupt street activity, diminish amenity, and reduce the area for public on-street parking.

## Objectives

- O1 Maximise retail frontage in streets and lanes.
- O2 Maximise pedestrian safety and amenity by minimising conflict between pedestrians and vehicles.
- O3 Entrances to parking and servicing should not dominate the streetscape. The design, size and location of access to parking and servicing areas are to be discrete.
- O4 Encourage cooperative approaches to car parking provision to reduce the number of vehicle access and egress points.
- O5 Coordinate vehicular access with the provision of active frontages to lanes.

### Controls

- C1 Vehicular access to a building is only permitted via a rear lane or rear right of way where possible.
- C2 If loading facilities are provided they must be located in a rear lane or side street.
- C3 Driveway widths should be kept to minimum dimensions. Driveway crossings should generally be 3m, however a maximum width of 6m may be considered depending on the site, the location of the access point, and the capacity of the car park. Wider driveways are permitted only when it is necessitated by compliance with Australian Standards.
- C4 Driveways to car parking above, below and at the ground floor level should be designed with minimal visual impact on the street, and maximum pedestrian safety. Pedestrian access to the development should be separate and clearly defined.
- C5 Garage doors should be set back from the building line.
- C6 Access ways to car parking should not be located in direct proximity to doors or windows to habitable rooms.
- C7 Devices such as car hoists and turntables may be incorporated to provide access to car parking above and below the ground floor.

Note: Driveways and kerb crossings must be sited to have minimum impact on the root zone of existing street trees, and be designed having regard to the Public Domain Improvements Plan (1999) and Streetscape Design Manual and advice from Council’s Technical Services Division.

#### **5.6.8.3 First floor car parking**

This chapter aims to maximise the active frontage at street level throughout the Double Bay Centre. As car parking is an inactive space that can disrupt the vitality of a street, the provision of street level car parking should be minimised. Where basement car parking is not possible, first floor car parking may be permitted. Where first floor car parking is necessary, careful design should ensure it is unobtrusive and does not detract from the streetscape.

### Objective

- O1 Ensure first floor car parking is unobtrusive and does not have a negative impact on streetscapes.

### Controls

- C1 First floor car parking is not permitted to address street fronts. Parking space must be located in the middle of blocks or toward the rear of the allotment.
- C2 First floor car parking that is incorporated within the building must be behind the building alignment and screened from the street.

- 
- C3 Facades screening car parks from the street must be high quality and allow natural lighting and ventilation.
  - C4 Vehicle access to first floor car parking must be integrated with the provision of active frontage to laneways. Vehicle access may not ramp along the street or lane alignments.
  - C5 Innovative approaches to car access and changing level, that minimise street impact and use space efficiently, such as car hoists, are encouraged.

#### **5.6.8.4 Site facilities**

Site facilities include loading areas, garbage areas, fire safety systems, mailboxes, external stores, laundries and clothes drying areas. Development should provide appropriate site facilities for retail, commercial and residential uses, and minimise impact on the streetscape.

#### **Objectives**

- O1 Ensure adequate provision of site facilities.
- O2 Ensure site facilities are accessible, functional and unobtrusive.

#### **Controls**

- C1 Site facilities, particularly garage areas, are to be visually integrated with the development to minimise their visibility from the street. Preferably orientate service areas within the building envelope, perpendicular to lane frontage. Such facilities must be located away from operable windows to habitable rooms to avoid amenity problems associated with smell. They must be located close to rear lanes where access is available.
  - C2 Ensure service areas are unobtrusive and have minimal lane presence. Preferably orientate service areas within the building envelope, perpendicular to lane frontage.
  - C3 Hydraulic fire services such as fire hydrants and booster installations are concealed. These services are to be:
    - a) Enclosed with doors if located in the building façade, or
    - b) Housed in a cabinet or enclosure if located external to the building.

The location, design colour and material of the doors, cabinet or enclosure are visually unobtrusive and suitably integrated with the development, including any fencing and landscaping.
  - C4 Lockable mailboxes must be provided close to the street, integrated with front fences or building entries.
  - C5 Buildings are designed to accommodate venting from ground floor uses to avoid potential impacts from exhaust and odour such as cooking smells.
  - C6 Air conditioning units and other plant equipment should not be readily visible from the public domain.
-

- C7 An electricity substation is to be suitably located, screened and/or concealed so it is not visible from the street, or any other adjoining public place. Council's preference is for a chamber substation. Any screening or enclosure to conceal the substation is to be visually unobtrusive and suitably integrated with the development, including the fencing and landscape design.
- C8 The design and location of all other aboveground utility infrastructure (such as electrical pillars etc.) should minimise visual clutter within the streetscape and provide for a continuous accessible path of travel, where practical to ensure safe and equitable pedestrian circulation for people of all abilities. (Where this provision and Ausgrid's requirements cannot both be satisfied, the applicant is to develop in consultation with Council and Ausgrid a solution that meets the acceptance of both consent authorities.)

Notes:

- At the DA stage the applicant should demonstrate that they have engaged with Ausgrid and have a network capacity assessment undertaken for the proposed development.
- Where a substation is required, the substation should be identified on the DA plans and addressed in *the SEPP 65 Design Verification Statement* (also see Apartment Design Guide Objective 3C-2 Amenity of the public domain is retained and enhanced).
- The DCP requirements for substations apply in addition to the Ausgrid Network Standards, such as *NS113 Site selection and construction design requirements for chamber substations*. Separate Ausgrid approval for the substation will be required.
- A dedicated access way/easement through the site to the substation will also need to be provided in accordance with the requirements of Ausgrid and Council.

---

### D5.6.9 Application of concessions

---

#### *Concessions for cultural facilities*

Cultural facilities are encouraged within the Double Bay Centre. Where applicants can demonstrate that the building form required for a cultural facility does not comply with the building envelope, flexibility with regard to the building envelopes may be granted.

- ▶ The following building uses are considered cultural facilities:
  - entertainment facilities; and
  - community facilities.
- ▶ Cultural facilities may be granted concessions with regard to permissible building envelope. No concessions to the LEP height and FSR controls will be permitted.
- ▶ To warrant concessions applicants need to demonstrate the proposed cultural facility:
  - maintains a building form compatible with the surrounding built form and streetscape;
  - meets the objectives of solar access; and
  - provides natural lighting and ventilation where possible.

#### *Concessions for corner buildings*

Strong corner buildings, which enhance the spatial definition of the public spaces they address, are encouraged. Selected corner buildings are eligible for an additional 0.5:1 of FSR under Woollahra LEP 2014, subject to meeting certain requirements.

Refer to Section 5.6.3.5 Corner buildings in this chapter and clause 4.4A of Woollahra LEP 2014, which outlines the controls that relate to corner buildings.

## Appendix 1: Transvaal Avenue Heritage Conservation Area

### A1.1 Introduction

#### Objectives

- O1 To retain and enhance the existing contributory buildings in Transvaal Avenue and to ensure that they retain their visual prominence in the streetscape.
- O2 To conserve the characteristics which give the Transvaal Avenue group of former residences its special sense of identity.
- O3 To encourage replacement of buildings that detract from the townscape character of Transvaal Avenue.

#### Application of management policy

The management policy contained in clause A1.5 applies to the Transvaal Avenue Heritage Conservation Area.

### A1.2 Historical outline

The property developer Edward Knox Harkness established Transvaal Avenue in 1900. The residential street was developed in the early 1900s with eight pairs of semi-detached houses, each named after the Transvaal victories that the British forces were enjoying in South Africa in the Boer War. The houses on the east side, Nos. 1-13 were named after the battles of the campaign and the houses on the west, Nos. 2-16 after the victorious British commanders, including Colonel Robert Baden Powell.

Transvaal Avenue was extended to its current length in the early 1920s, with the subdivision of the Lowlands Estate and the construction of six new detached dwellings. The avenue remained a quiet residential street until the 1970s when pressure mounted to develop the area. The ensuing debate finally resulted in the street being declared a conservation area under Woollahra LEP 2014 1995 and it remains so today.

### A1.3 Character and description

#### Existing character

The character of Transvaal Avenue is formed by a unique relationship between the consistent and richly decorated Federation style semi-detached cottages, the street trees and landscaped



central garden, the subdivision pattern which does not allow for car parking on site and its distinctive building form.

Each cottage has a steeply pitched terracotta hipped roof with chimneys and a gable with decorative timber barges. Occasionally bays occur at the street frontage. Low roof forms occurring towards the rear are covered in corrugated sheet metal.

The combination of these factors makes the shapes of buildings in relation to the street highly visible and its general bulk and massing critical.

The façade treatment and consistency of detailing are very important contributors to the streetscape character. The lack of awnings, the single storey building mass and close proximity of each pair of buildings tie the buildings together into a cohesive group within the street, while the variety of façade decoration adds visual interest and creates diversity within that overall cohesiveness.

#### Description of former residential building groups – Nos. 2-16 and 3-13

Roof	Terracotta hipped roof form with projecting gables at street front. Chimneys in face brickwork with unpainted stucco detail and terra cotta chimney pots.
Verandahs	Verandahs with timber fretwork across the width of the building as a continuation of the main roof plane with a tiled projecting bay or gable. End blade walls with decorative brackets and urns. Tessellated tiled verandahs with marble thresholds.
Walls	Tuck pointed face brickwork with rendered base course.
Entrance doorways	Separated by projecting party walls.
Fences	Dividing front fences with timber square top palings.
Windows	Vertically proportioned double hung in painted timber.
Small front gardens	Now all paved.
Original interiors to the front two rooms	Coffered plaster ceilings with marble fireplaces separating the front two rooms.

### A1.4 Summary statement of significance

---

The Transvaal Avenue retail strip provides a physical record of a significant historical phase in the evolution of the Double Bay Commercial Centre.

The group of buildings provides physical evidence of the working class residential boom at the end of the 19th century by a renowned local developer, Edward Knox Harkness, who was responsible for many fine Federation styled semi-detached cottages within the Double Bay area.

---

The quality and distinction of the architectural decoration of the turn of the century buildings exemplifies the economic boom in that period and the expansion of residential development after the introduction of the tram service to the City in 1894 and from Rose Bay in 1898.

The area provides an historical record of the time through the naming of each of the properties and the avenue after the victories of the British force in the South African Boer War. Transvaal is the alternate name of the South African Republic.

The consistency and relative intactness of the cottages with their fine Federation but Gothic style brick and tile construction, stucco details and timber fretwork creates a distinctive and aesthetically pleasing character.

The uniformity of form and scale within the Harkness development of the single storey brick and tile semi-detached cottages contributes to the unique qualities of the housing group within the Double Bay commercial precinct.

The streetscape has high aesthetic value which is enhanced by the closed vistas and the carefully maintained street trees and landscape works at the northern end.

The area has social significance to the local community, demonstrated through the involvement of the local community during the 1980s when the area was granted heritage conservation area status after the number of objections raised to the proposed redevelopment of the group.

## A1.5 Management policy

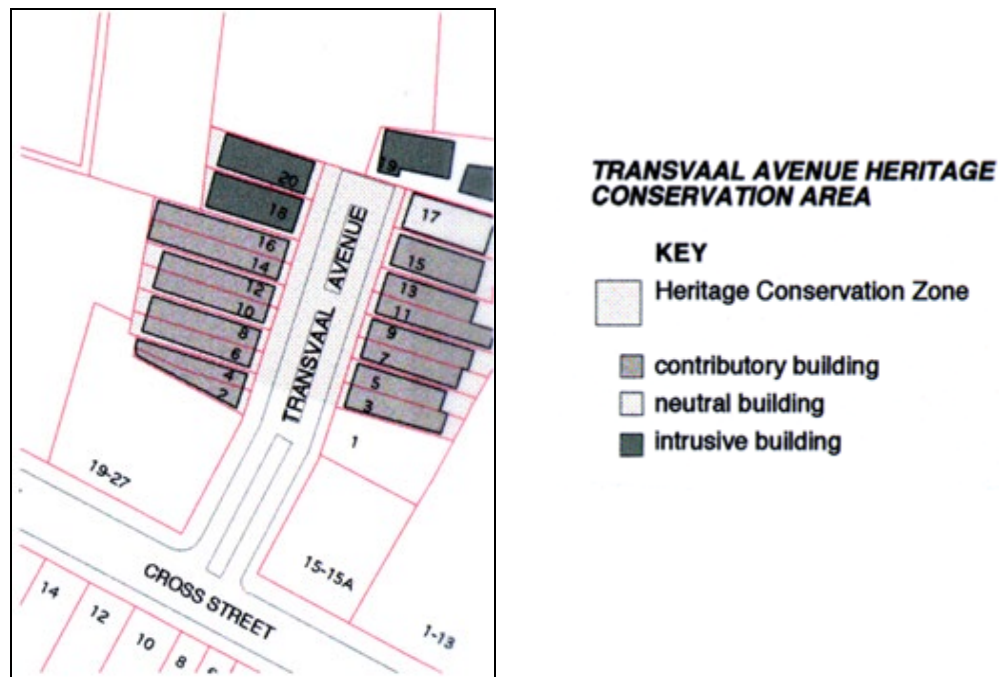
---

**The following policy statement encapsulates the approach to the development and care of the heritage significance of the Transvaal Avenue Heritage Conservation Area:**

In recognition of the heritage significance of the Transvaal Avenue Heritage Conservation Area and its contributory buildings, the impact of proposed development on individual buildings, on the character of the streetscape and on the overall significance of the area must be considered as part of the assessment of all development applications in the area.

A heritage impact statement must accompany all development applications involving proposed changes to the external appearance of properties within the area, unless those proposed changes are deemed by Council to be of a minor nature and to not result in adverse heritage impacts.

Evidence of the historical fabric of the buildings must be retained and conserved, including evidence of the previous residential historical uses. Former place names and the decorative architectural features of the front two rooms and of the front roof form and elevations are of particular interest and must be retained and conserved.



The original terracotta roof forms, chimneys and chimney pots must be retained and conserved.

Significant and contributory shopfronts and interiors must be retained and conserved. Other shopfronts may either be retained or replaced unless identified as intrusive, in which case, replacement is the preferred option.

Contributory buildings in the Transvaal Avenue Heritage Conservation Area map, must be retained and conserved - specifically Nos. 2-16 and 3-15 Transvaal Avenue. These buildings must comply with the diagram of proposed controls below.

Contributory buildings which have been structurally altered should be reconstructed to their original appearance as viewed from the street front.

Buildings whose contribution is ranked as neutral in the Transvaal Avenue Heritage Conservation Area map shall (preferably) be retained and enhanced, but alternatively, may be redeveloped.

Buildings whose contribution is ranked as intrusive or neutral which are proposed to be redeveloped must comply with Section D5.5 Built form envelopes: Control drawings and D5.6 Development controls.

Additions must be located at the rear behind an extension of the existing terra cotta tile roof form, screened by a gablet form as indicated in the diagram of proposed controls. Additions must have regard to their potential impact on the character of the streetscape and should not result in changes in the apparent scale, form or bulk of existing buildings.

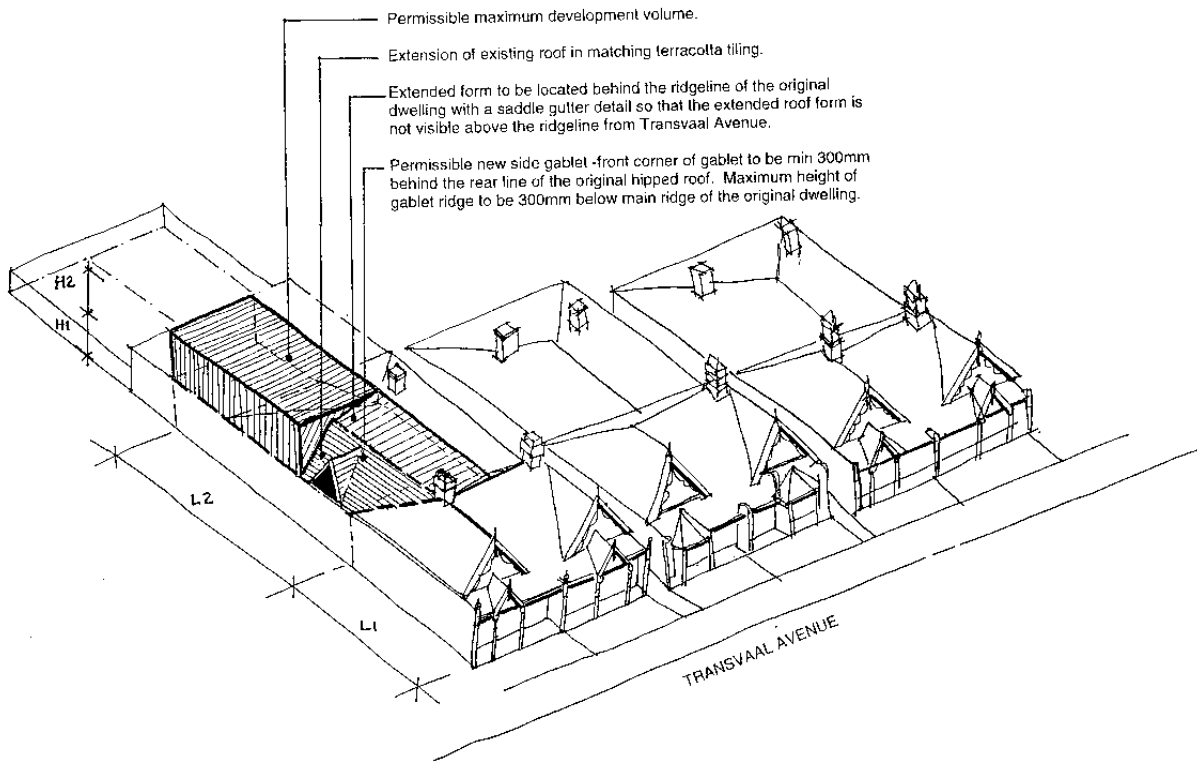
Off-street car parking is not permitted.

Significant street trees must be retained. The planting of trees and shrubs on the verges by property owners is discouraged unless the species and location is in accordance with Council’s Street Tree Master Plan.

**Diagram of proposed controls**

**KEY**

- L1 Existing main section with tiled hip roof
- L2 Existing secondary wing with corrugated steel roof
- H1 Height to be equal to existing eaves
- H2 Maximum permissible height to be equal to the height of the existing front ridgeline



## Appendix 2: Kiaora Lands

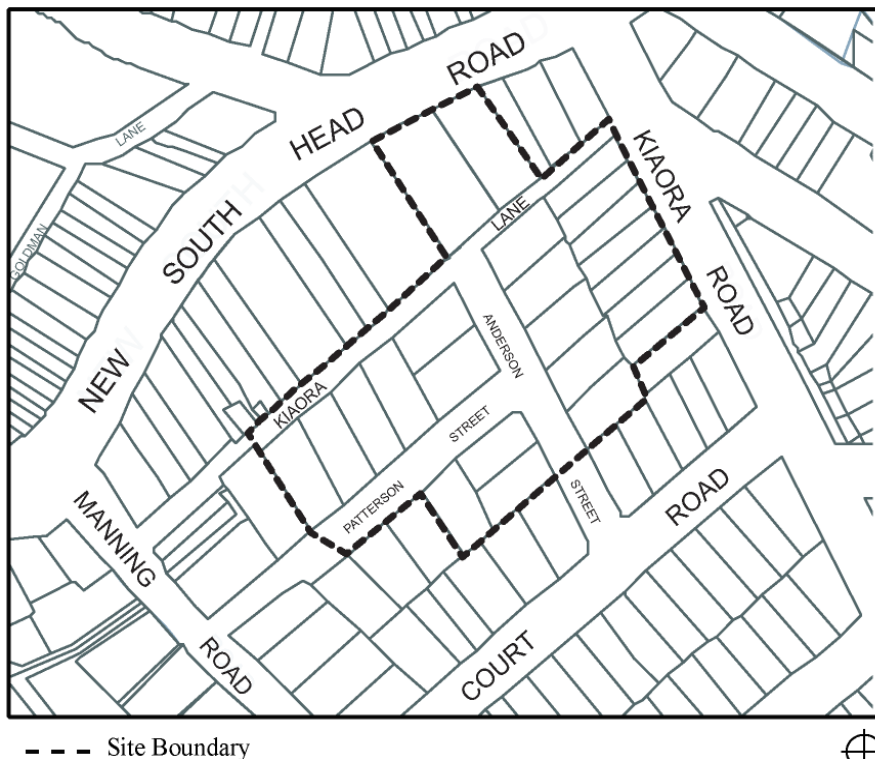
### A2.1 Background

The Kiaora Lands site shown in Figure 1 is a significant local precinct within the Double Bay Commercial Centre. The site comprises substantial public and private land holdings. In recognition of the precinct’s importance to the Double Bay Centre’s function and commercial vitality special provisions have been prepared.

Appendix 2 provides development objectives, strategies, principles and controls for the Kiaora Lands site. Other relevant objectives and controls are provided in Sections D5.1 to D5.6 of this plan. The provisions of Appendix 2 prevail over those in other parts unless otherwise specified.

Land beyond the boundary shown on Figure 1 may be included within the site for the purpose of development such as awnings, signs, architectural features, public domain improvement works and car parking.

**FIGURE 1** Kiaora Lands



---

## A2.2 Objectives

---

The objectives for development of the Kiaora Lands site are:

- 01 To maximise the public benefit from ownership and development of the Council owned lands that form part of the site.
- 02 To develop a high quality public domain that demonstrates a high standard of planning, urban design and landscape architecture.
- 03 To protect and enhance the commercial role of the Double Bay Centre both locally and generally throughout Metropolitan Sydney.
- 04 To provide a catalyst for increased business activity and private sector development in Double Bay.
- 05 To increase the attractiveness of Double Bay as a place to live, work and shop.
- 06 To improve traffic and pedestrian safety in Kiaora Lane.
- 07 To minimise the effects of traffic, car parking and loading on local residents.
- 08 To provide sufficient accessible and safe public and private car parking for development on the site.
- 09 To provide additional public car parking that assists with meeting future needs within the Double Bay Centre.
- 010 To establish high quality community facilities and public domain.
- 011 To establish high quality commercial and retail development, including an expanded supermarket.
- 012 To integrate the new private and public domain development with Double Bay's existing public spaces and built form.
- 013 To maintain or improve the amenity of adjoining residential areas and to protect the surrounding environment.
- 014 To minimise the impact of development on adjoining properties and properties in the immediate locality.
- 015 To ensure that development on private and public land is accessible.
- 016 To provide a prominent public connection between Kiaora Lane and the public spaces of Knox Street and Guilfoyle Park.
- 017 To ensure that the development meets best practice standards in environmentally sustainable design.

---

## A2.3 Development framework

---

### A2.3.1 Urban structure of Kiaora Lands site

#### Layout and street pattern

- ▶ Provides pedestrian connections.
- ▶ Provides a large footprint for a potential supermarket.
- ▶ Allows the closure of public roads to provide for a large footprint supermarket and car parking.

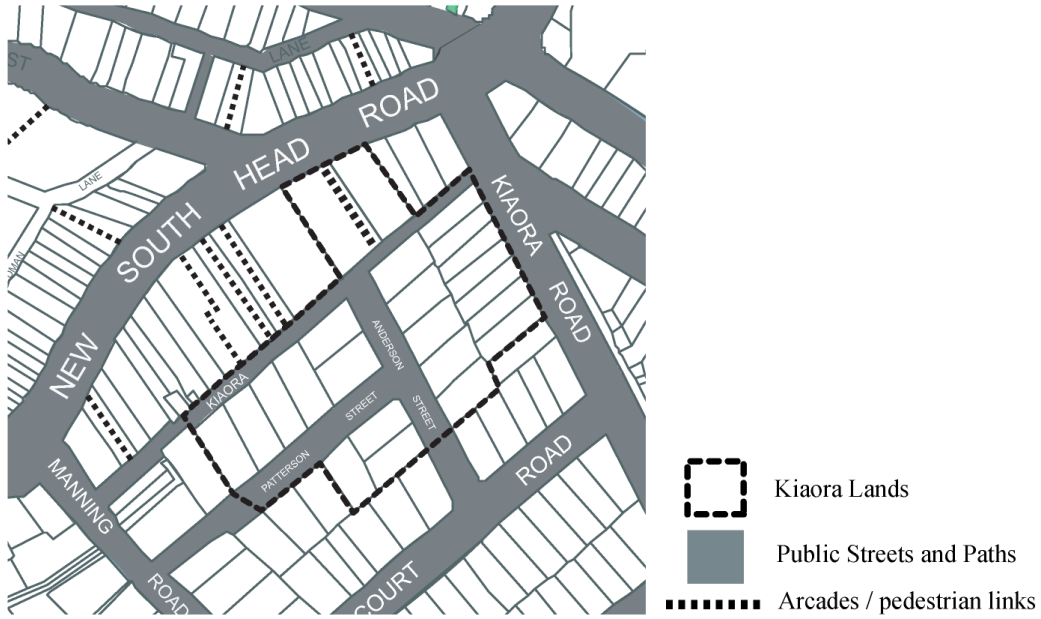
#### Built form

- ▶ Reinforces the form of buildings constructed to the street boundary along New South Head Road.
- ▶ Provides a transition between commercial and residential areas.

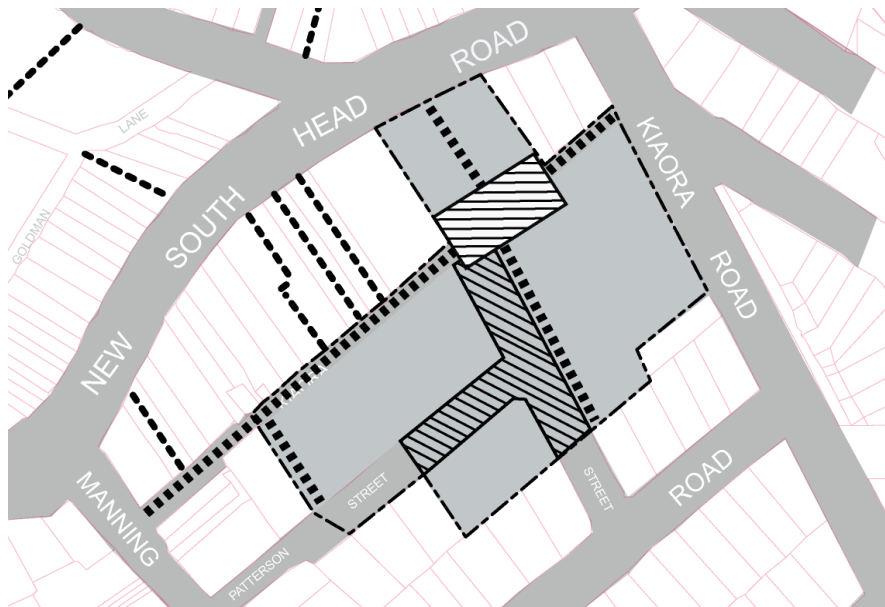
#### Public domain

- ▶ Provides a new arcade between Kiaora Lane and New South Head Road.
- ▶ Upgrades Kiaora Lane.
- ▶ Provides a public plaza adjoining Kiaora Lane.
- ▶ Provides new street tree planting.
- ▶ Provides an integrated pedestrian network.

**FIGURE 2** Existing structure



**FIGURE 3** Future structure





---

### **A2.3.2 Street character**

This section describes the desired future character of existing streets within the Kiaora Lands site.

It takes into consideration the scale of each street and the interface between the public and private domains. The redevelopment of the Kiaora Lands site will bring about changes to the character of the existing streets.

The Double Bay Centre Public Domain Improvements Plan (1999) should be used as a guide to works in the public domain such as street tree planting, pavement design and street furniture. Applicants should also speak with Council's Technical Services staff prior to submitting applications for work in the public domain.

The description of street character is to be read in conjunction with the built form envelope controls in Section A2.4 of this appendix.

#### ***Kiaora Road***

##### **Existing character**

The Kiaora Road section of the Kiaora Lands site is currently residential and is dominated by modest scaled attached and detached bungalows. It is located opposite the Jamberoo Creek stormwater channel, which has been identified as one of several urban projects in the Double Bay Centre Public Domain Improvements Plan. Kiaora Road forms an edge of the commercial centre and reads as a continuum of the important Post Office intersection on New South Head Road.

##### **Desired future character objectives**

- O1 Ensure that the built form on Kiaora Road is integrated with the desired future character of the commercial centre.
- O2 Create a distinctive and identifiable edge to the commercial centre.

##### **Strategy**

- a) Provide highly articulated buildings constructed to the street boundary.
- b) Strengthen the built form at the corner of Kiaora Road and Kiaora Lane.
- c) Design loading docks to minimise conflicts between pedestrian and vehicles. Pedestrians are to be given priority where car park and loading dock crossovers occur.
- d) Provide new street planting to contribute to the tree lined nature of Kiaora Road.

### ***Patterson Street***

#### **Existing character**

Patterson Street is currently a leafy residential street with detached single storey dwellings on the south side with the Council car park and a three storey residential flat building on the north side.

#### **Desired future character objectives**

- O1 Allow the closure of the eastern part of Patterson Street to accommodate a suitable footprint for a supermarket and car parking.
- O2 Reinforce the existing leafy character at the western part of Patterson Street.
- O3 Provide a transition between the commercial centre and the adjacent residential areas.

#### **Strategy**

- a) Retain the existing London Plane tree on the northern side of Patterson Street opposite No.4 Patterson Street.
- b) Retain existing street trees where feasible and supplement with new street tree planting.
- c) Minimise conflict between pedestrians and vehicles.
- d) Provide a dedicated pedestrian connection between Patterson Street and the car park.
- e) Built form should be designed to contribute to the street. Outlook from the supermarket retailing area should be considered at the end of these streets as a means of providing surveillance along the street, hence increasing safety and animating and enlivening the building, particularly at night.

### ***Anderson Street***

#### **Existing character**

Anderson Street is currently a leafy tree lined street with car parks to both sides at the northern end.

#### **Desired future character objectives**

- O1 Allow for the closure of part of the street to provide a suitable footprint for a supermarket and car parking.
- O2 Reinforce the existing leafy character at the southern end of Anderson Street.

---

### Strategy

- a) Provide a dedicated pedestrian access and egress point between Anderson Street and the car park.
- b) Built form should be designed to contribute to the street. Outlook from the supermarket retailing area should be considered at the end of these streets as a means of providing surveillance along the street, hence increasing safety and animating and enlivening the building, particularly at night.

### *New South Head Road*

#### Existing character

The New South Head Road frontage is currently occupied by the single storey Woolworths supermarket.

This building provides a blank single storey frontage which is setback from the back of pavement approximately 1.2m.

#### Desired future character objectives

- 01 Reinforce the character of building to the street boundary along New South Head Road.
- 02 Provide a built form that recognises, and is sympathetic to, the adjacent heritage item.
- 03 Establish a new civic building and presence.
- 04 Provide a new, clearly visible arcade which connects New South Head Road to development south of Kiaora Lane.

### Strategy

- a) Comply with the street edge profile specified in Section D5.5 Built form envelopes: Control Drawings, except as stated in the following:
  - Clearly indicate the entry point to the arcade on the elevation. Refer to Section A2.5.7 The new arcade.
  - Setback the building to the west of the arcade at least 1.35m from the street boundary. Refer to edge condition D (West).
  - Omit the 3.5m setback at the upper level of the New South Head Road frontage east of the arcade. Refer to edge condition D (East).
- b) Provide a sophisticated high quality design response that reflects the civic role of the building.

### ***Kiaora Lane***

#### **Existing character**

The existing character of Kiaora Lane is compromised by its ‘back of house’ status, with loading vehicles, exposed on-site loading bays and rubbish bins. The lane lacks containment and activity on its south side due to the at-grade car park.

Pedestrian activity is generated by the car park and the four existing arcades that feed onto the lane from New South Head Road. Narrow and inadequate pathways on the lane cause conflict between vehicles and pedestrians.

#### **Desired future character objectives**

O1 To make Kiaora Lane into a significant part of the public domain in the Double Bay Centre.

The controls for Kiaora Lane are located in Section A2.5.5 The new public domain.

### A2.3.3 Street trees

#### Existing character

The existing character of Kiaora Lands is strongly influenced by the mature trees on the site.

#### Desired future character objectives

O1 Retain the tree lined character of streets on and surrounding Kiaora Lands.

#### Strategy

Retain the following trees:

	Tree type	Botanical name	Location
1	London Plane	<i>Plantanus orientalis</i>	Road verge north side of Patterson Street approx. 85m east of Manning Road
2	London Plane	<i>Plantanus orientalis</i>	Road verge south side of Patterson Street approx. 85m east of Manning Road
3	London Plane	<i>Plantanus orientalis</i>	Road verge south side of Patterson Street approx. 65m east of Manning Road
4	London Plane	<i>Plantanus orientalis</i>	Road verge north side of Patterson Street approx. 45m east of Manning R Road
5	London Plane	<i>Plantanus orientalis</i>	Road verge east side of Anderson Street approx. 40m north of Court Road
6	London Plane	<i>Plantanus orientalis</i>	Road verge west side of Anderson Street approx. 35m north Court Road
7	London Plane	<i>Plantanus orientalis</i>	Road verge west side of Anderson Street approx. 20m north of Court Road
8	London Plane	<i>Plantanus orientalis</i>	Road verge east side of Anderson Street approx. 15m north of Court Road
9	Swamp Mahogany	<i>Eucalyptus robusta</i>	Road verge west side of Kiaora Road approx. 20m south of Kiaora Lane
10	Southern Mahogany	<i>Eucalyptus botryodios</i>	Road verge west side of Kiaora Road approx. 30m south of Kiaora Lane
11	Oak	<i>Genus quercus</i>	Road verge south side of Kiaora Lane approx. 55m east of Manning Road

## A2.4 Built form envelopes

Building envelopes illustrate the limits of permissible building height, depth and location and are described on the control drawings for New South Head Road and Kiaora Lane/Patterson Street.

Note: The statutory maximum building heights are in Woollahra LEP 2014. The maximum building heights are also shown in the chapter to provide detail to the envelope controls.

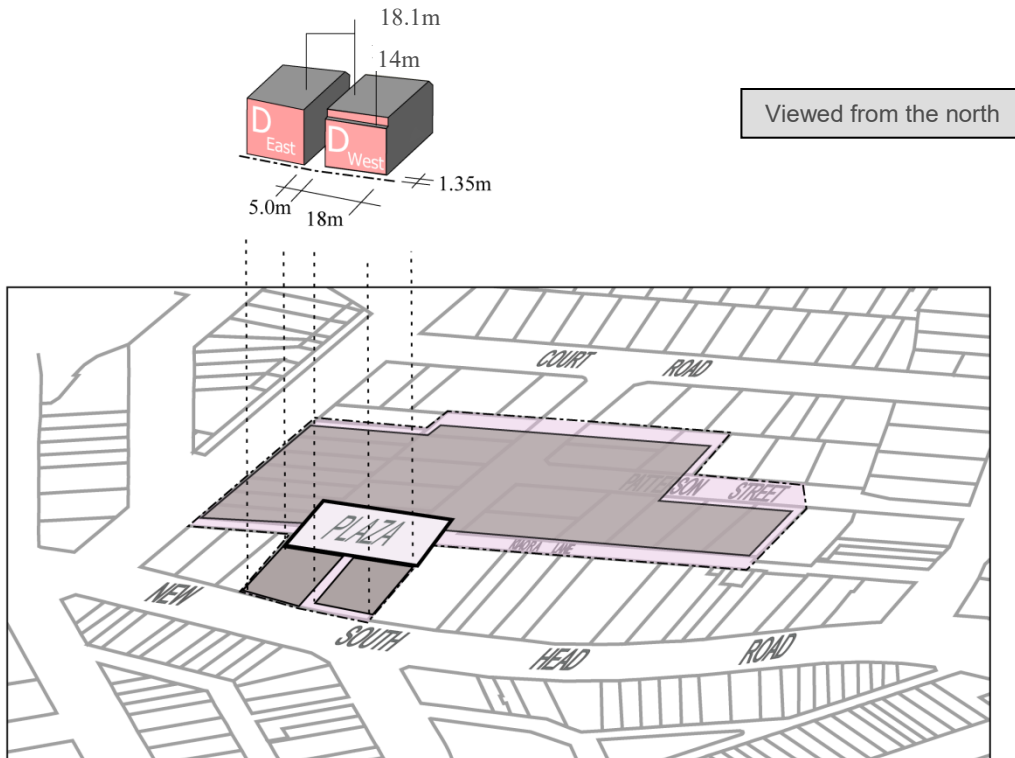
**FIGURE 4**

**Edge conditions**

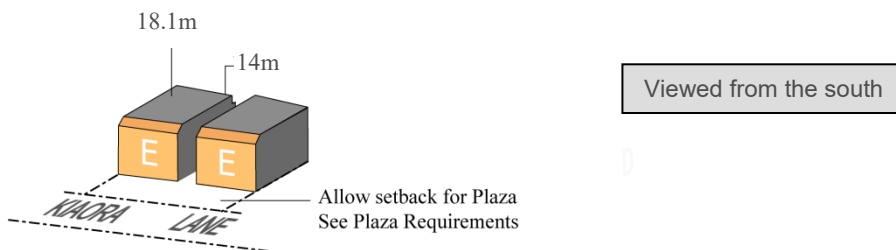
D (East) – Boundary edge façade up to 18.1m to the east part of the frontage.

D (West) – A 1.35m setback to west part of frontage up to 14m and with a 3.5m setback up to 18.1m.

E – 32° inclined plane springing from the southern edge of the Plaza. Frontage a minimum of 18m from the southern edge of the Plaza. Variation to the inclined plane may be considered if the principal dining /public area on the south side of the plaza has sunlight access at 12 noon in mid-winter.



Note: The shape and location of the plaza in the diagram above is indicative only



**FIGURE 5**

**Edge conditions**

A – 32° inclined plane springing from 3.5m south of the boundary, and with a building setback from the boundary of 7m for the ground floor level and 13.8m for levels above.

B – 64° inclined plane springing from the boundary, and a building setback of 1.5m from the boundary.

C – 32° inclined plane springing from the southern side of Patterson Street.

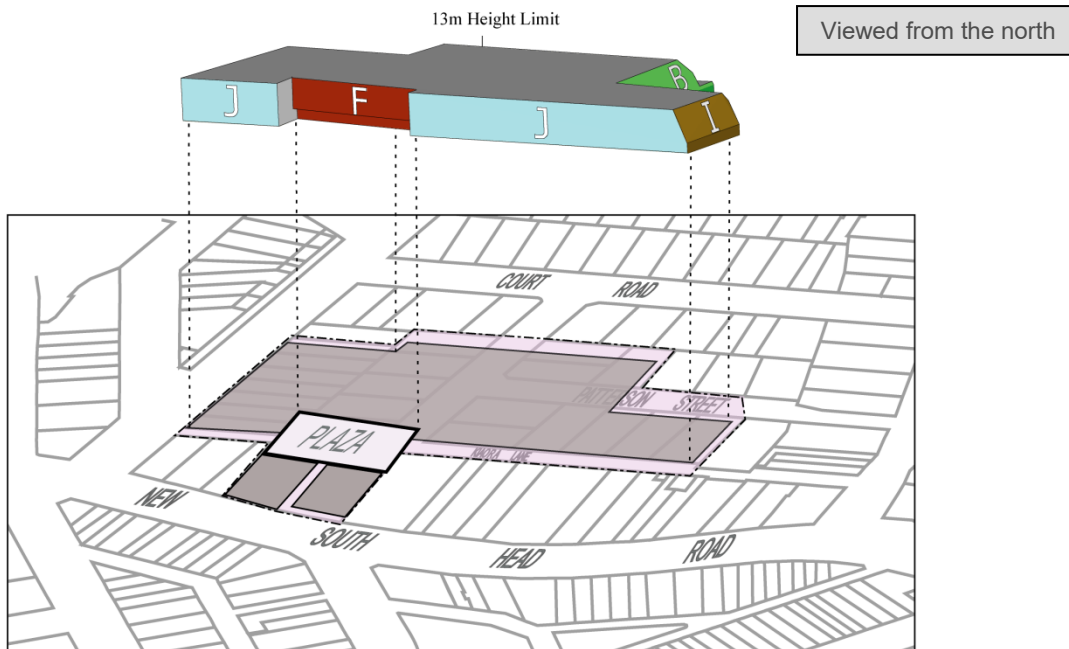
F – Plaza edge façade up to 13m. 2m deep colonnade at ground level.

G – Kiaora Road edge frontage up to 13m.

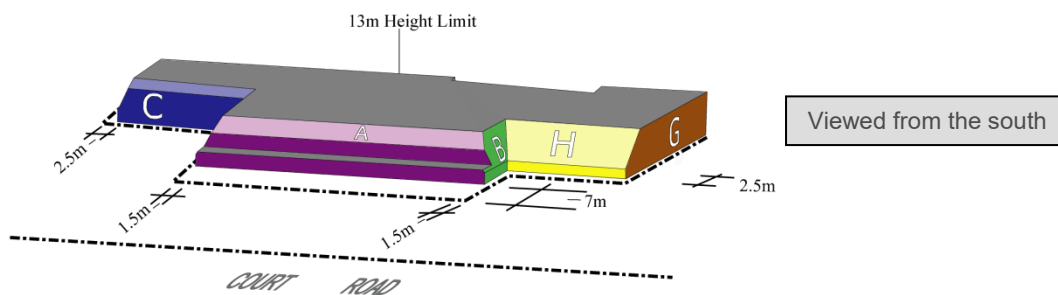
H – 45° inclined plane springing from a point 3m above ground level and 2.5m from the boundary to the adjacent property.

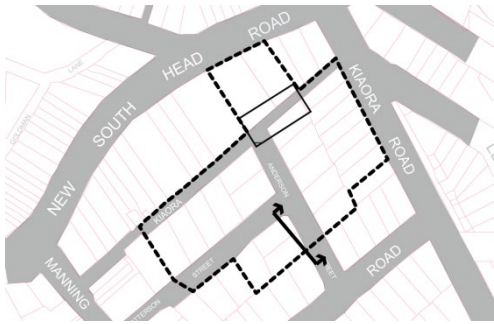
I – 64° inclined plane springing from the boundary, and a building setback of 2.5m from the boundary.

J – Kiaora Lane edge frontage up to 13m. A minimum of 7.9m from northern boundary of Kiaora Lane.



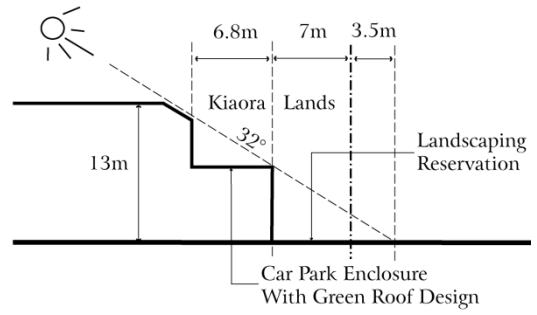
**Note:** The shape and location of the plaza in the diagram above is indicative only



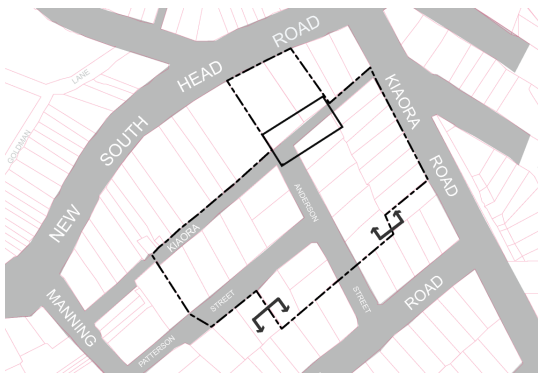


Condition A

Location

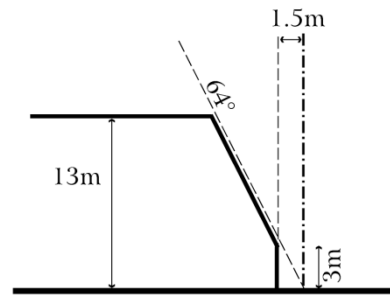


Section



Condition B

Location

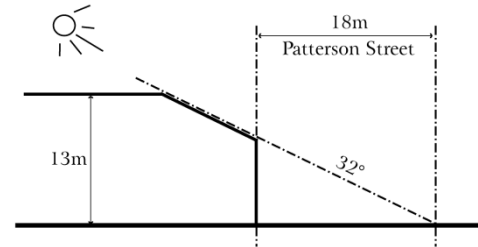


Section



Condition C

Location

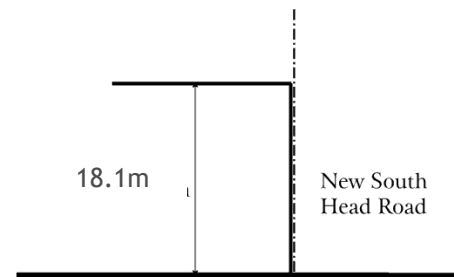


Section



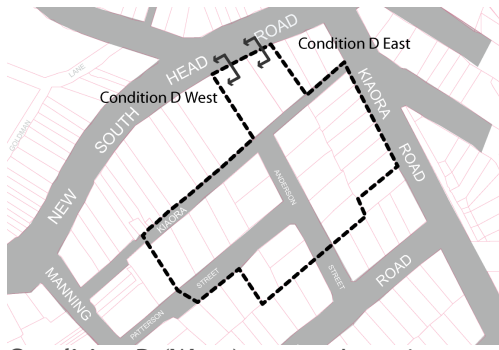
Condition D (East)

Location



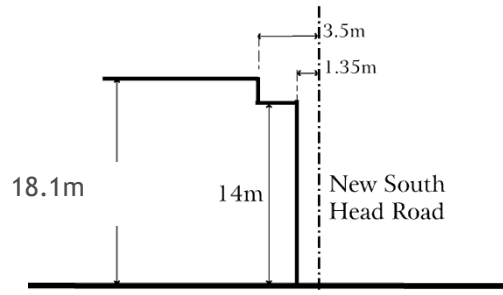
Section





Condition D (West)

Location

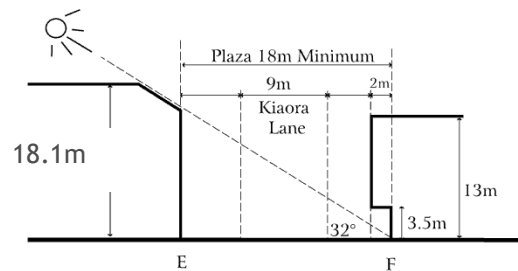


Section



Conditions E + F

Location

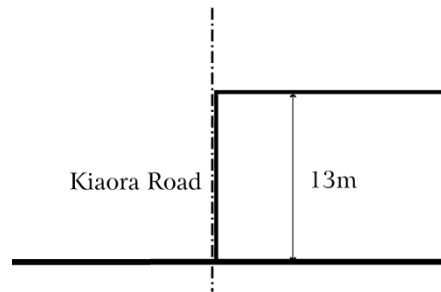


Section



Condition G

Location

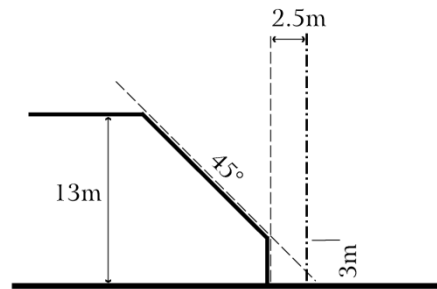


Section

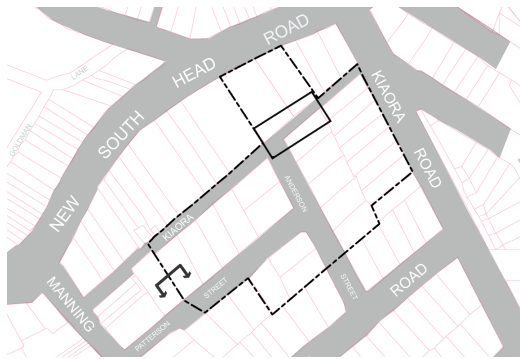


Condition H

Location

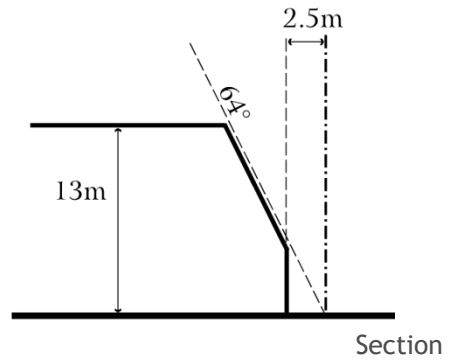


Section



Condition I

Location

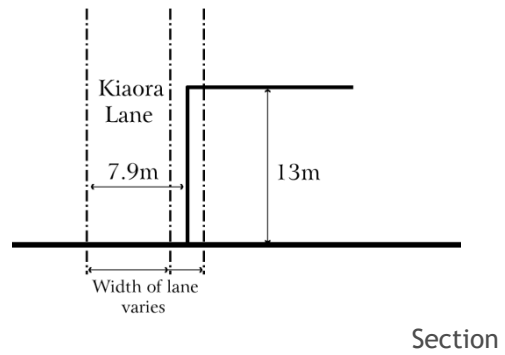


Section



Condition J

Location



Section

## A2.5 Development controls

---

This section contains development controls that apply specifically to the Kiaora Lands site. These are to be read in conjunction with the relevant development controls in Sections 5.6.1–5.6.7 of this chapter.

### A2.5.1 Use

The image and vitality of the Double Bay Centre will benefit from the mix of uses that is permissible on the Kiaora Lands site.

These uses include:

- ▶ shopping facilities such as a major supermarket, specialty food outlets and additional retail floor space, all of which supplement the existing distinctive mix of small scale shops, boutiques, restaurants, cafes and commercial premises that characterise the centre;
- ▶ community facilities that will give a civic presence to the centre;
- ▶ commercial premises; and
- ▶ parking.

### A2.5.2 Height

The height of the building envelope for the Kiaora Lands site is indicated on the control drawings in Section A2.4 Built form envelopes.

The following table provides the approximate floor to floor heights for different uses:

Retail (small footprint)	4m
Supermarket	6m
Library	5.5m
Commercial	3.5m
Car parking	3m

### **A2.5.3 Built form south of Kiaora Lane**

#### **Principles**

- P1 The functional and operational requirements of large retail outlets should not compromise the qualities of the adjacent public domain.
- P2 The built form should not compromise the amenity of adjoining properties.
- P3 The built form should be compatible with producing attractive public domain.

#### **Controls**

- C1 Comply with edge conditions in Section A2.4 Built form envelopes, Figure 5.
- C2 The building setback included in edge condition A is to accommodate deep soil landscaped areas to mitigate the impact of the built form. The minimum width for deep soil landscaped area is 4.5m.
- C3 The supermarket should not present uninterrupted blank walls onto streets and public spaces.
- C4 The building frontage facing Kiaora Lane, Patterson Street and Kiaora Road is to be articulated so as to break up the length of the built form and reflect the vertical proportions of development in the Double Bay Centre.
- C5 The main frontage of the supermarket is to be highly transparent and activated.
- C6 Access to specialty retail outlets is to be directly from the public domain.
- C7 Awnings are to be provided along the Kiaora Road and Kiaora Lane retail frontages.
- C8 Provide wet weather protection at the entrance of the supermarket.
- C9 The retail and office development at Kiaora Road should provide articulated walls and windows to street.
- C10 All mechanical plant is to be designed on the basis that if that equipment could operate at any time of the day or night, then its noise emission component, when measured at the nearest, or at any other residential property façade, must not exceed the nocturnal background level.

The cumulative noise level from all relevant items of mechanical plant and equipment, when measured at the same location must not exceed the nocturnal background level by more than 5dB(A).

Note: The background noise level is to be measured on a windless Tuesday night which is normally the quietest night of the week. The results of this measurement must not be degraded by the noise of passing traffic, or by the noise from vehicles entering, or exiting the Anderson Street entry and exit. This may require the background noise level to be measured when the Anderson Street entry and exit is closed.

- 
- C11 The use of the premises must not give rise to noise which exceeds the relevant nocturnal background sound levels by more than 5dB(A) when measured at the façade of the nearest, or any other residential premises.
  - C12 External pipes, vents, fans or other items of plant must be individually specified to produce components of noise emission which are less than the relevant background sound level at the façade of the nearest of any other residential property. All such plant is to be located as far away as possible from residential properties. In the event that pipes, high velocity air discharge outlets or other pipe work are installed on the face of the building or extend through the rooftop, those outlets must be equipped with acoustically effective discharge silencers and have their directional discharge pointing in a north-westerly direction.
  - C13 The façade to Patterson Street is to be highly articulated with the use of a variety of materials and finishes to mitigate its bulk and visual impact.
  - C14 Screen landscaping sufficient to mitigate the bulk of the building is to be provided in the perimeter landscape areas.
  - C15 The landscaped area between the Court Road property boundaries and the proposed supermarket is to be a minimum of 7m wide.
  - C16 The landscaped area is to be free of car parking.
  - C17 The ground floor car parking where it faces residential properties to the south is to be completely enclosed.
  - C18 The ground floor level car park roof is to have a green roof design.

#### ***A2.5.4 Built form north of Kiaora Lane***

##### **Principles**

- P1 The building is to be of exemplary design commensurate with its civic function.
- P2 The building should not compromise the adjoining heritage item.
- P3 The pedestrian connection between New South Head Road and Kiaora Lane is to be strengthened.

##### **Controls**

- C1 Comply with edge conditions in Section A2.4 Built form envelopes, Figure 4.
- C2 At the New South Head Road frontage, the setback between the adjacent heritage item to the west and the northern end of the arcade is to be a minimum of 1.35m from the street

boundary to reflect that point on the adjoining heritage item where the gable parapet wall springs up from the façade parapet.

- C3 The building is to accommodate a clearly visible arcade which connects New South Head Road to development south of Kiaora Lane (see Section A2.5.7 The new arcade).
- C4 A public plaza is to be provided to the south of the building (see Section A2.5.8 The new public plaza).
- C5 Active retail or civic frontages are to be provided to the New South Head Road frontage, the plaza and the arcade.
- C6 Access to specialty retail outlets is to be directly from the public domain.

### ***A2.5.5 The new public domain***

The public domain of Double Bay is characterised by an intricate pedestrian network of streets, lanes, walkways and arcades, making it a highly permeable shopping centre.

The planning and urban design provisions for the Kiaora Lands site reinforce this permeability with requirements for a new arcade between New South Head Road and Kiaora Lane, a new plaza, restrictions on vehicle movements along Kiaora Lane and the maintenance of pedestrian links between Kiaora Lane and Anderson Street.

The Double Bay Centre is also characterised by a series of distinctive public places such as Knox Street, Bay Street, Guilfoyle Park and Transvaal Avenue.

The public domain of the Kiaora Lands site will be a premier public space within the centre’s hierarchy of spaces. The character of the public domain is largely derived from the relationship between the buildings that address and form the public domain. It is also dependent upon the nature and quality of streetscape elements such as paving, street furniture, lighting and planting material.

### **Principles for all public domain on Kiaora Lands**

- P1 Ensure the public domain is of a high standard and exemplary urban design.
- P2 Provide a high level of pedestrian amenity and create improved public spaces with a community focus.
- P3 Consider the needs of people with access difficulties.
- P4 Reduce conflicts between pedestrians and vehicles.
- P5 Enrich and enliven the main spaces by providing high quality design elements and/or works of contemporary art.

---

## Controls

- C1 The public domain design should consider the Double Bay Centre Public Domain Improvement Plan 1999 and seek advice from Council's Technical Services staff prior to submitting a development application.
- C2 The pavement system used in the main spaces is to be of predominantly segmental stone elements (laid on a suitable concrete base).
- C3 The pavement system is to comply with AS/NZS 4586 Slip resistance classification of pedestrian surface materials for safety and slip resistance.
- C4 Ensure that shops are level with the adjacent external public spaces.
- C5 Reinstate the tree lined nature of the streets and lanes.
- C6 Awnings must be designed to accommodate street trees.
- C7 Minimise the presence of vehicles in Kiaora Lane and the plaza.
- C8 Use bollards to allow freedom of pedestrian movement while preventing vehicular access to specific areas. Bollards are to be used sparingly and are not to be used simply to define edges to vehicular paths.
- C9 Minimise use of signage.
- C10 The Davis Cup commemorative plaque is to be reinstated and is to be explained with interpretive signage. The position of the plaque is to be determined with regard to the location of the original tennis courts.

### **A2.5.6 Kiaora Lane**

Kiaora Lane is to function as a shared pedestrian and vehicular way for the whole of its length. Its role as a service lane will continue but this is to be subservient to its primary role as a high quality public space. The predominant character of the lane is to be that of a high quality, pedestrian dominated space that maximises pedestrian connections between other public spaces and building entrances.

## Principles

- P1 Ensure that Kiaora Lane has good connections to existing arcades.
- P2 Enhance the pedestrian experience and amenity of the lane.
- P3 Reinforce the spatial definition of the lane.
- P4 Encourage a mix of uses onto the lane including community facilities and food retailing.
- P5 Enhance public safety and security of the lane.
- P6 Encourage an active shared zone.

P7 Provide a high quality urban space.

**Controls**

- C1 Frontages to Kiaora Lane are to be active retail or civic functions.
- C2 Kiaora Lane is to be a shared zone as defined by the Roads and Traffic Authority.
- C3 Provide a high quality unified pavement treatment along the full length of Kiaora Lane from Manning Road to Kiaora Road.
- C4 The selection of materials for the shared zone in Kiaora Lane is to identify it as a space where pedestrians have priority.

**A2.5.7 The new arcade**

A major arcade is to be provided between New South Head Road and Kiaora Lane.

**Principles**

P1 Provide a major public pedestrian link between New South Head Road and Kiaora Lane.

**Controls**

- C1 The arcade must be naturally lit from above and naturally ventilated.
- C2 The arcade is to be a minimum width of 5m at the ground and upper levels.
- C3 The arcade is to be designed for 24 hour public access.
- C4 The entrance to the arcade at New South Head Road is to be clearly identified through architectural design.
- C5 The shop frontages to the arcade are to be designed to create a visually unified whole.
- C6 The floor treatment to the arcade should read as a continuation of the adjacent public spaces.

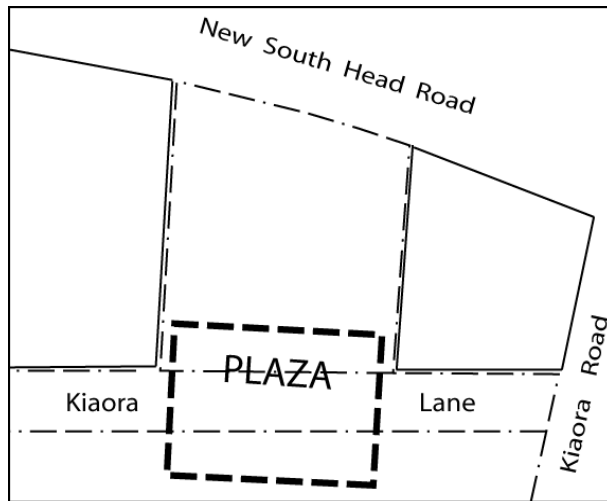
**A2.5.8 The new public plaza**

A new pedestrian plaza is required as part of the redevelopment of the site. The plaza is to be designed as a special place. It will require site specific design elements and the incorporation of public art. The space should be modulated to allow for defined areas of public circulation, seating areas and potential outdoor eating areas.



**FIGURE 6** Location of plaza

Note: The shape and location of the plaza in the diagram below is indicative only



### Principles

- P1 Ensure that the plaza has a distinctive character that is commensurate with its importance as a key civic space in the Double Bay Centre and the civic role of the adjoining building which fronts New South Head Road.
- P2 Active retail and civic uses are to face the plaza.
- P3 Ensure the plaza is animated by sunlight.

### Controls

- C1 Provide a space which accommodates the section diagram (see edge condition diagram E + F in Section A2.4 Built form envelopes).
- C2 Ensure that the floor of the plaza receives solar access at midday on June 21.
- C3 Provide a 32° inclined plane as a component of the building envelope controls to ensure solar access during winter. Refer to condition E of Section A2.4 Built form envelopes.
- C4 The plaza is to be designed as an identifiable public space, allowing 24 hour access.
- C5 The plaza is to be designed primarily as a place for people, but will permit vehicles to pass through under the shared zone arrangements for Kiaora Lane.
- C6 The plaza is to be a minimum of 18m in any direction. It is to have an area of at least 500m<sup>2</sup> which is a single space such that people in any two places in the plaza can see each other.
- C7 Frontages to the plaza are to accommodate active retail or civic functions.

- C8 The majority of the area of the plaza is to be uncovered and free of overhanging buildings, colonnades and awnings.
- C9 An overhang of 2m, 3.5m above the finished ground level of the plaza is permitted on the southern side of the plaza.
- C10 Overhanging balconies of 2.4m on the first floor level are permitted on up to 30% of the building on the northern side of the plaza.
- C11 The northern edge of the supermarket, where it adjoins the plaza, should provide windows overlooking the plaza.
- C12 The plaza shall have a distinctive unified ground treatment.

#### ***A2.5.9 Public toilets***

Public toilets are to be provided.

#### **Principles**

- P1 Provide public toilet facilities on the Kiaora Lands site.
- P2 Public toilets are to be in a safe and convenient location.

#### **Controls**

- C1 Position the public toilets close to the plaza in a safe and convenient location.
- C2 Ensure adequate surveillance to the entries of the public toilets.
- C3 Access from the plaza to the public toilets is to comply with the performance criteria in the Building Code of Australia DP1 DP2 DP3.

#### ***A2.5.10 Car park and loading dock design***

#### **Principles**

Ensure the design of the car park:

- P1 Facilitates ease of access.
- P2 Facilitates walking and bicycle use.
- P3 Provides a high level of safety for all uses.
- P4 Minimises opportunities for crime to property and persons through consideration of crime prevention through environmental design principles.
- P5 Minimises the amenity impacts of the car parking and loading docks on surrounding properties and public domain.

---

## Controls

- C1 Provide a car park layout that maximises visibility and legibility.
- C2 Ensure dedicated pedestrian entry and egress points to the public car parking are available from the plaza, Kiaora Lane, Patterson Street, Anderson Street and the supermarket entry.
- C3 Access to liftwells and stairways or directions to the car park access points must be clearly visible from every car parking space.
- C4 Car parking spaces for disabled people should be located in highly visible and accessible locations and in proximity to lifts and ramps.
- C5 Dedicated bicycle parking is to be provided in a convenient location at the rate of 1 bicycle per 25 car spaces.
- C6 Dedicated motorbike parking is to be provided in a convenient location at the rate of 1 motorbike per 25 car spaces.
- C7 Lighting throughout the car park must conform to the requirements of AS 2890 *Off Street Car parking* and AS 1680.2 *Interior Lighting*.
- C8 Pedestrian access ways to, from and around the car park must be well lit.
- C9 A ground level through-site pedestrian footpath linking the plaza and Anderson Street must, as a minimum, incorporate the following design and operational features:
  - a) dignified, direct and unobstructed access from the plaza to Anderson Street;
  - b) have a minimum clear width of 2.5m;
  - c) have a minimum headroom of 3m.
- C10 Vehicular access to the car park and loading docks south of Kiaora Lane is not to be provided from Kiaora Lane, unless it can be demonstrated that a turntable solution for the Kiaora Lane/Patterson Street loading dock is not feasible.
- C11 Access to loading docks may be from Kiaora Road and Patterson Street only, unless it can be demonstrated that a turntable solution for the Kiaora Lane/Patterson Street loading dock is not feasible.
- C12 If a loading dock is located off Patterson Street, the design and size of the dock must be limited to accommodate fixed rigid vehicles only (i.e. not semi-trailers).
- C13 Vehicle ramps between car parking levels are to be enclosed to contain noise and light spill impacts. The walls and ceiling of the ramp enclosure are to be provided with an appropriately selected and effective fire resistant, sound absorbing facing (an approved acoustical spray, or modular acoustical panels/tiles) to provide an effective reduction of the reverberant characteristics of that area.
- C14 Loading docks are to be designed to minimise conflict between pedestrians and vehicles.
- C15 Loading docks are to be as unobtrusive as reasonably possible.

- 
- C16 Loading dock doors are to be no larger than the dimensions required for functional operation.
- C17 Loading docks must be fully enclosed.
- C18 The loading docks are to provide for the forward entry and exit of service vehicles. The docks are to be designed so that all truck reversals can take place within the loading docks with the loading dock doors closed.
- C19 The loading docks are to be provided with automated doors with a surface mass greater than 3kg/m<sup>2</sup> and the sides, head and thresholds of each is to be designed to obviate, or minimise any undesirable sound leakage.
- C20 The loading dock doors are to be designed so that their noise emission components when either opening or closing are no more than 5dB(A) above the background sound level when measured at the façade of the nearest, or any other residential property.
- C21 The ceiling, as well as significant areas of the walls of the loading docks are to be provided with an appropriately selected and effective fire resistant, sound absorbing facing (an approved acoustical spray, or modular acoustical panels/tiles) to provide an effective reduction of the reverberant characteristics of that area and ensure there is minimum possibility of the loading docks impacting on neighbours.
- C22 The consent authority may impose conditions restricting the operation of the loading docks and car parks to specified hours.
- C23 A *Carparking and Loading Dock Plan of Management* is to be prepared and submitted with the development application for the comprehensive redevelopment of the site. The Plan of Management must address the following matters:
- a) the designated areas in which motorcycles will be permitted to park;
  - b) the areas within the car park from which motorcycle traffic will be excluded;
  - c) the hours of operation, or restrictions, that may be imposed in relation to the use of the upper level car park and the mechanisms through which any such restrictions may be further strengthened in order to deal with unexpected situations;
  - d) explicit restrictions in relation to times of use of specific entries or exits which may be imposed to control, or minimise potentially intrusive nocturnal noise emission. This requirement most aptly applies to the Anderson Street entry and exit because vehicular movement both within, and outside the car park will be exacerbated by the nocturnal use of that entry and exit;
  - e) signage to identify entry restrictions for vehicles which may be too large, too high or too noisy to enter the car parks; and
  - f) appropriate signage and designated areas of the ground floor car park where patrons of licensed premises should park their vehicles in order to minimise the potential for neighbour noise at night.
- C24 Appropriately designed and acoustically effective barriers are to be provided around the perimeter of the ground floor car park. The uppermost 2m or 3m section of the acoustic barrier is to be angled inwards. The acoustic barriers are to be provided with a sound
-

---

absorbing lining to reduce the sound reflections and reverberant characteristics of the car park.

- C25 To achieve the noise goal referred to in C11 Section A2.5.3 Built form south of Kiaora Lane, a roof is to be provided over the car park, adjacent to the Kiaora Road vehicular entry and exits at the rear of 8 Kiaora Road. The underside of that roof is to be provided with an appropriately selected and effective fire resistant, sound absorbing facing (an approved acoustical spray, or modular acoustical panels/tiles) to provide an effective reduction of the reverberant characteristics of that area.
- C26 The soffit of the supermarket floor is to be provided with an appropriately selected and effective fire resistant, sound absorbing facing (an approved acoustical spray, or modular acoustical panels/tiles) to provide an effective reduction of the reverberant characteristics of that area.
- C27 The car park floors, as well as the interconnecting ramp between the ground level and rooftop car park are to have a surface that will not generate tyre squeal. The development application must include the specifications for the quality of the surface finish which may be achieved by the addition of an appropriate and functionally effective particular dusting or surface coating or by the application of fine sand on the finished floor surface before it has cured which will ensure positive tyre adhesion, and preclude tyre squeal problems.
- C28 The interconnecting ramp between the ground level and rooftop car park is to have a smooth primary surface and not parallel ribbed surfaces. The ramp should incorporate small angled parallel grooves in a chevron pattern which may be cut into the surface of the cured concrete. The surface must be designed to preclude structural vibration and adverse related intrusive noise levels (or noise radiation from the main building structure) as well as provide positive tyre adhesion in the presence of water or oil.
- C29 The car park is to be equipped with an effective electronic vacant car space identification system through which a driver may more rapidly find an empty car space to minimise the need to circle around the car park to find where they can park.
- C30 Appropriately designed and effective acoustic barriers are to be provided around the perimeter of the rooftop car park to prevent noise impact on surrounding residential properties.
- C31 The car park ramp is to be fully enclosed as required to meet the noise goal set out in C11 Section A2.5.3 Built form south of Kiaora Lane. If necessary, the enclosure is to extend beyond the point where the ramp surface intersects with the upper level car park floor.
- C32 The ceiling and walls of the entry and exit structure to Kiaora Road are to be provided with an appropriately selected and effective fire resistant, sound absorbing facing (an approved acoustical spray, or modular acoustical panels/tiles) to provide an effective reduction of the reverberant characteristics of that area.
- C33 The south-eastern wall of the car park entry/exit to Kiaora Road must extend to the street alignment.

### **A2.5.11 Roof design**

The roofscape is a significant visual component of the development and can be seen from the surrounding suburbs of Edgecliff, Darling Point and Bellevue Hill. These controls seek to reduce potential visual and amenity impacts of the roof top parking.

#### **Principles**

- P1 The roofscape should not present as an obtrusive and single unarticulated mass.
- P2 The roof is to be designed to minimise the amenity impacts to surrounding residences.

#### **Controls**

- C1 A combination of landscape treatments and shade structures should be used so that the roofscape does not present as an obtrusive and single unarticulated mass.
- C2 A combination of landscape treatments and shade structures should be used to minimise glare from the surface of the roof top and the cars parked on the roof.
- C3 The roof treatment is to provide shade structures for vehicles.
- C4 Surface treatments which minimise noise are to be used to minimise tyre squeal.
- C5 To contain noise, motorbike parking should be limited to the ground level.
- C6 The roof design should minimise light spill from cars.
- C7 The design of fixed lighting on the roof should comply with AS 428-1997 *Control of the Obtrusive Effects of Outdoor Lighting* (urban standards).

### **A2.5.12 Flooding and water sensitive urban design**

The Kiaora Lands site is flood prone land. Major redevelopment of the site will affect existing overland flow paths. The new plaza should provide an overland flow path for stormwater. Thorough and informed consideration of flooding issues at the design stage is essential to ensure

---

that redevelopment does not have detrimental impacts on the surrounding development, infrastructure and public domain.

### Principles

- P1 Ensure there is no increase in stormwater runoff from the site.
- P2 Ensure the built form on the site does not block overland flow, in such a way as to impact on adjoining properties.
- P3 Use water sensitive urban design techniques to reduce demand on the Sydney water supply and to provide water for plant irrigation.
- P4 Ensure development on the site is adequately protected from flooding.
- P5 The new plaza should act as a part of the overland flow path for stormwater.

### Controls

- C1 Development is to be designed having regard to the recommendations of a flood study prepared by a suitably qualified hydraulic engineer. The flood study must identify how property on and off the site, including the public domain, will be protected from the 1 in 100 years flood event.
- C2 Development, including services, below the 1 in 100 years flood level is to be designed to be safe in a flood event.
- C3 Provide a Site Emergency Response Plan (SERP) demonstrating the ability to safely evacuate persons to a safe refuge area.
- C4 On site detention is not required.
- C5 Collect rainwater for non-potable uses on site.
- C6 The treatment of the roof should ensure that stormwater runoff is not increased and that the quality of runoff from the site fulfils the requirements of the Australian and New Zealand Environment Conservation Council and Agriculture and Resource Management Council of Australia and New Zealand Guidelines 2000 (<http://www.environment.gov.au/topics/water/water-quality/national-water-quality-management-strategy>).

#### ***A2.5.13 Environmentally sustainable design***

The Kiaora Lands project is to provide best practice environmentally sustainable design. Refer to Chapters E2 Stormwater and Flood Risk Management, E5 Waste Management and E6 Sustainability for further information.

### Principles

- P1 Promote environmentally sustainable design.
-

## Controls

- C1 Development must be designed to provide for best practice environmentally sustainable design outcomes as may be established through the Green Star Certified Rating system, or a similar tool.



# Chapter D6 Rose Bay Centre

Part D ▶ Business Centres

CHAPTER D6 APPROVED ON 27 APRIL 2015  
AND COMMENCED ON 23 MAY 2015

Last amended on 8 December 2023



# Chapter D6 ▶ Rose Bay Centre

## Contents

- D6.1 INTRODUCTION ..... 1**
  - D6.1.1 Land where this chapter applies ..... 1
  - D6.1.2 Development to which this chapter applies..... 2
  - D6.1.3 Objectives..... 2
  - D6.1.4 Relationship to other parts of the DCP..... 4
  - D6.1.5 How to use this chapter..... 4
  
- D6.2 UNDERSTANDING THE CONTEXT ..... 7**
  - D6.2.1 Siting ..... 7
  - D6.2.2 Historical development ..... 7
  - D6.2.3 Built form..... 7
  - D6.2.4 Public parks and facilities ..... 8
  - D6.2.5 Access and circulation ..... 8
  
- D6.3 URBAN STRUCTURE ..... 9**
  
- D6.4 STREET CHARACTER ..... 11**
  - D6.4.1 New South Head Road..... 12
  - D6.4.2 Newcastle Street ..... 13
  - D6.4.3 Dover Road ..... 15
  - D6.4.4 Wilberforce car park edge..... 16
  - D6.4.5 Wilberforce Avenue..... 17
  - D6.4.6 Richmond Road ..... 18
  - D6.4.7 Norwich Road ..... 19
  - D6.4.8 Caledonian Road ..... 20
  - D6.4.9 Collins Avenue ..... 21
  - D6.4.10 Vickery Avenue..... 22
  
- D6.5 BUILT FORM ENVELOPES: CONTROL DRAWINGS ..... 23**
  - D6.5.1 Urban form methodology ..... 23
  - D6.5.2 Explanatory legend ..... 24
  - D6.5.3 Rose Bay Centre urban form ..... 25
  - D6.5.4 Control drawing 1 ..... 26
  - D6.5.5 Control drawing 2 ..... 27
  - D6.5.6 Control drawing 3 ..... 28
  - D6.5.7 Control drawing 4 ..... 29
  - D6.5.8 Control drawing 5 ..... 30
  
- D6.6 BUILT FORM: DEVELOPMENT OBJECTIVES AND CONTROLS ..... 31**
  - D6.6.1 General format ..... 31
  - D6.6.2 Use..... 32
  - D6.6.3 Urban character ..... 33
  - D6.6.4 Visual and acoustic privacy ..... 47
  - D6.6.5 Private open space ..... 51
  - D6.6.6 Solar access and natural ventilation..... 56

D6.6.7 Parking and servicing .....	58
D6.6.8 Geotechnology and hydrogeology .....	61
D6.6.9 Site facilities .....	62
D6.6.10 Application of bonuses.....	64

## D6.1 Introduction

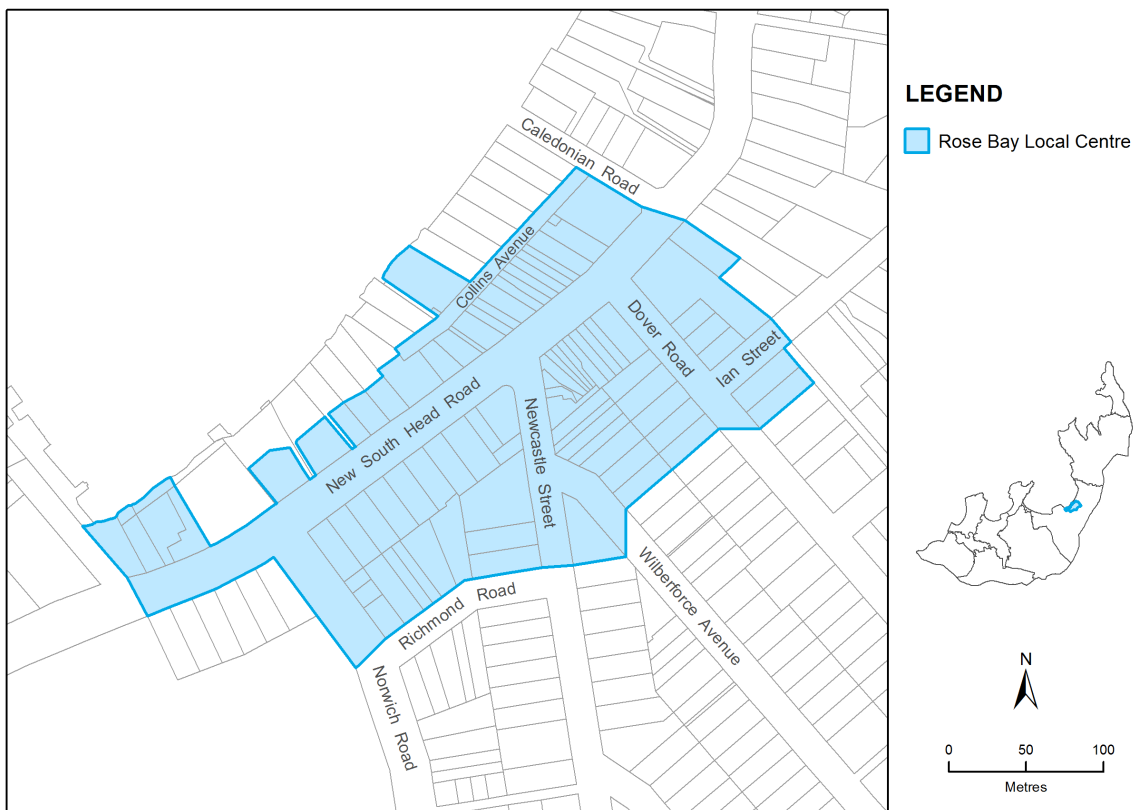
This is Chapter D6 of the Woollahra Development Control Plan 2015 (DCP), Part D Business Centres. It establishes detailed controls to guide future development in the Rose Bay Centre.

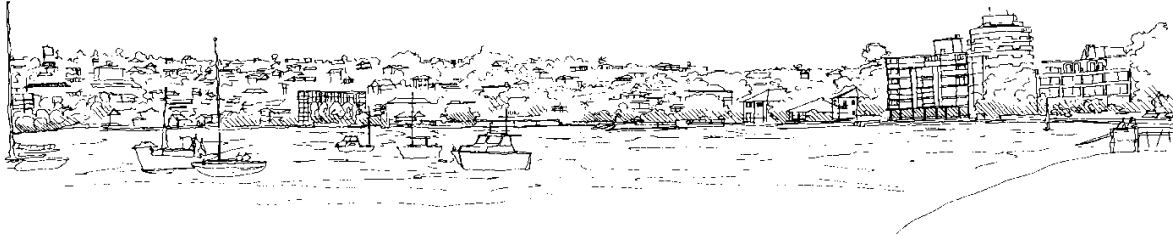
Rose Bay is a unique local centre which enjoys a privileged position adjacent Sydney Harbour at the foot of the South Head peninsula. The historical development of Rose Bay has focused the centre on New South Head Road. The consistent scale of buildings and the distinctive landscape quality evoke an appealing urban village character which is warmly valued by local residents and users of the centre.

### D6.1.1 Land where this chapter applies

This chapter applies to the Rose Bay Centre, as identified in Figure 1.

**FIGURE 1** Location plan



**FIGURE 2** View of Rose Bay from the harbour

### D6.1.2 Development to which this chapter applies

---

This chapter applies to development that requires development consent.

Generally this will be mixed use retail, business, office and /or residential development, but may also include permitted uses such as child care centres, community facilities, and other uses as permitted by Woollahra LEP 2014.

Development within the Rose Bay Centre should retain and enhance the village character of the centre.

### D6.1.3 Objectives

---

The Rose Bay Centre should develop into a high quality medium density urban village with a balanced mix of retail, commercial, residential and leisure uses, which cater primarily for the needs of the local community.

The intention of this chapter is to strengthen and enrich the existing urban structure of the Rose Bay Centre as follows:

- O1 To retain and enhance the village atmosphere of the Rose Bay Centre.
  - a) To encourage contiguous ground floor retail frontage to ensure liveliness of the centre;
  - b) To limit the width of street frontage of individual shops to preserve the ‘small shop’ character of the centre;
  - c) To promote a coherent building scale and high quality development;
  - d) To retain and improve the pedestrian environment by encouraging through block pedestrian connections at nominated locations, and requiring continuous awnings in nominated areas;
  - e) To enhance the way development contributes to a sense of place;
  - f) To improve vehicle parking and servicing in the centre and reduce vehicular and pedestrian conflicts;
  - g) To enhance the public domain of Rose Bay Centre by considering the Public Domain Improvement Plan and Streetscape Design Manual 1999; and

- 
- h) To encourage the provision of community services and facilities as part of site redevelopments.
- 02 To improve the connections between the Rose Bay Centre and the harbour foreshore.
    - a) To encourage the creation of a public square between New South Head Road and Collins Avenue, opposite Percival Park;
    - b) To encourage the construction of pedestrian arcades as part of developments in nominated locations, to improve public access through to the foreshore; and
    - c) To maximise views to the water from the public domain.
  - 03 To create a memorable image for Rose Bay.
    - a) To create defined entrances to the centre;
    - b) To provide a stronger public domain focus to the centre; and
    - c) To provide direction and certainty of outcome in relation to build form to ensure:
      - a coherent street scale;
      - that new development meets the desired future character;
      - a variety of building types; and
      - a high level of amenity.
  - 04 To improve the Rose Bay Centre’s public domain.
    - a) Improve the public domain of Rose Bay by using the Public Domain Improvement Program and the Streetscape Design Manual to inform changes;
    - b) Identify the location of and building envelopes surrounding a new public square in the centre, which support the use of bonus height and FSR controls in the Woollahra Local Environmental Plan 2014 (Woollahra LEP 2014);
    - c) To improve pedestrian amenity throughout the centre; and
    - d) To retain the important role that public transport plays in the Rose Bay Centre.
  - 05 To foster the diverse mix of uses in the Rose Bay Centre.
    - a) To retain and enhance the combination of retail, commercial, public and residential uses that characterise Rose Bay; and
    - b) To encourage a range of flexible accommodation to support the diverse mix of uses in the centre.
  - 06 To conserve and enhance the visual and environmental amenity of all buildings and places of significance in the centre.
    - a) To identify character buildings within the Rose Bay Centre; and
    - b) To ensure that alterations and additions to character buildings and heritage items are compatible in scale, form and material with these buildings and items, and adjoining developments.
  - 07 To improve traffic and parking management in the centre and reduce vehicle and pedestrian conflicts.
-

- 
- a) To identify parking and servicing arrangements for the centre.
- 08 To introduce stormwater management measures to control localised flooding, stormwater quality and quantity, and improve the visual and environmental impact of stormwater drainage, particularly at the harbour foreshore.
- a) To facilitate the creation of the Rose Bay Square between New South Head Road and the drainage reserve off Collins Avenue to mitigate against local flooding of the centre;
  - b) To improve the visual and environmental impact of existing stormwater outlets into Rose Bay; and
  - c) To coordinate overland flow management with public domain improvements.
- 09 To enhance the diverse character of streets in the Rose Bay Centre.
- a) To carry out public domain improvements to preserve and enhance the unique character of the individual streets in the centre; and
  - b) To provide specific design criteria for both public and private domain to allow for, and enhance the character of, individual streets.

#### D6.1.4 Relationship to other parts of the DCP

---

This chapter is to be read in conjunction with the other parts of the DCP that are relevant to the development proposal, including:

- ▶ Part E: General Controls for All Development - this part contains chapters on Parking and Access, Stormwater and Flood Risk Management, Tree Management, Contaminated Land, Waste Management, Sustainability, Signage and Adaptable Housing.
- ▶ Part F: Land Use Specific Controls - this part contains chapters on Child Care Centres, Educational Establishments, Licensed Premises and Telecommunications.

#### D6.1.5 How to use this chapter

---

This chapter is applicable to all development and redevelopment work on private land in the Rose Bay Centre.

The Rose Bay Public Domain Improvements Plan (1999) should also be used as a guide to works in the public domain, and includes details of street tree planting, footpaths, street furniture, and vehicular and pedestrian crossings.

This chapter of the DCP is structured as follows:

##### D6.1 Introduction

General information about this chapter, including why the chapter was prepared, its aims, and its relationship to other planning documents.

---



---

## D6.2 Understanding the context

Provides a summary description of the existing urban context. For a more detailed analysis refer to the Rose Bay Centre Urban Design Study, upon which this chapter was based.

## D6.3 Urban structure

Provides an understanding of the current urban structure of the centre, and identifies whether the site is located in the Core Area or a Transition Area. Objectives for the future character, form and function of the Rose Bay Centre are described here.

## D6.4 Street character

Specifies the desired future character of the street(s) in which the site is located.

### Using the built form controls

The development controls are derived from the Rose Bay Centre Urban Design Study. They respond to the objectives set out in Section 6.1.3 and the desired future character described in Section D6.4. Controls have been designed for each individual site in the Rose Bay Centre to optimise development, whilst taking into consideration the potential of adjoining properties and public spaces. This Urban Form Methodology provides a greater certainty of outcome for Council, community and site owners.

Built form controls in the Rose Bay Centre are expressed in:

- ▶ graphic form as *building envelopes* on the *control drawings*; and
- ▶ written and illustrated form as *development controls*.

These controls must be used in conjunction.

## D6.5 Built form envelopes: Control drawings

The controls are in the form of building envelopes, which set the position of development on each site.

There are two control drawings for every site in the Rose Bay Centre showing:

- ▶ the ground floor level controls; and
- ▶ the upper floor level controls.

The control drawings are accompanied by a descriptive legend, and further explanation is provided in Section D6.6.

## D6.6 Development objectives and controls

These explain in written and illustrated form the following four areas of building development:

1. **Use:** Refers to building use such as retail, commercial and residential.
  2. **Urban character:** Includes building envelopes, setbacks, heritage, architectural resolution, roof design, awnings, public art, privacy, signage and advertising, and outdoor eating.
-

3. **Open space:** Includes landscaped area, above ground open space such as balconies and roof terraces, and front fences.
4. **Solar access:** Deals with provision of sunlight to the public and private domain.

Three dimensional images assist in the interpretation of the development guidelines and controls.

A special section deals with the application of bonuses as incentives to the provision of specific public benefits. Applicants seeking bonuses should also refer to the Rose Bay Public Domain Improvements Plan.

All applications will be determined on their individual merits. Applications which depart from any controls or seek concessions for provision of public services or facilities should address:

- ▶ why the specific guidelines or controls should be relaxed for the subject site;
- ▶ how the village atmosphere of the Rose Bay Centre will be maintained; and
- ▶ the urban design and economic benefits to the centre that will result from the proposal.

---

## D6.2 Understanding the context

### D6.2.1 Siting

---

The Rose Bay Centre is strategically located at the neck of the Eastern Suburbs peninsula, one block from the harbour, just north of the large park system and recreational area which occupies the lowest part of the Rose Bay basin.

Important distinguishing characteristics of the centre are its consistent low to medium scale buildings, exceptional landscape quality, and diverse mix of local services, residential apartments and commercial uses, which combine to produce a distinctive village character.

The centre straddles New South Head Road, around its intersections with Dover Road and Newcastle Street. These two streets play an important role as urban connectors, linking New South Head and Old South Head Roads.

### D6.2.2 Historical development

---

The building stock in and around the centre represents a cross section of 20th century architecture of varying quality. Originally part of a series of large private land grants, Rose Bay's early urban development intensified with the extension of the tramline along New South Head Road after 1898.

Due to its key location at two intersections, the centre was able to develop along Newcastle Street and Dover Road. The estates were subdivided and resubdivided between 1900 and 1930 producing the small lots which characterise the centre today. Larger sites generally occur at the fringe of the commercial centre, the result of recent amalgamations.

St Mary Magdalene Church and tower, the Rose Bay Hotel on the corner of Dover Road, the former post office, the Royal Sydney Golf Course and five Norfolk Island pines in Vickery Avenue are the listed heritage items in the immediate vicinity. These buildings and trees contribute prominently to the area's character and help form the established image of Rose Bay. Character buildings that are of architectural merit and are important within the urban form and streetscape of the centre are identified in this chapter of the DCP.

### D6.2.3 Built form

---

There are a surprising number of single storey and two storey buildings in the centre, given the statutory LEP maximum building height (14.1m). With few exceptions the four storey buildings are relatively new. There are two residential towers, developed in the 1960s and 1970s, of six and eight storeys between New South Head Road and the Harbour. The only other tall building element is the tower of St Mary Magdalene Church on New South Head Road.

---

### D6.2.4 Public parks and facilities

---

There are two pocket parks, Pannerong Reserve and Percival Park, within the centre and two others, Tingira Reserve and Caledonian Road, on its periphery. All of these parks, with the exception of Pannerong Reserve, enjoy harbour frontage, but are underutilised due to their poor amenity and visibility from the centre. Opportunities exist for the improvement of existing pocket parks and creation of new squares, to provide accessible outdoor spaces in the centre where people can rest while shopping or to eat lunch.

There are numerous leisure facilities in the vicinity; however no community buildings exist in the centre.

### D6.2.5 Access and circulation

---

There is a strong pedestrian ambience in the centre due to the relatively continuous street activity, compact layout and low to medium building scale. Improved footpaths and crossings would increase pedestrian amenity, and reduce the potential for pedestrian/traffic conflict which exists in some areas. Better pedestrian access to the harbour foreshore would benefit the centre.

The Parking Strategy contained within the Public Domain Improvements Plan should be used as a guide to improve parking management.

### D6.3 Urban structure

Urban structure comprises the inter-relationship of topography and orientation, street layout, pattern of buildings, location of parks and public facilities, and any special natural or human made features, of a given area. The Rose Bay Centre is located in a valley close to the harbour foreshore, surrounded by gracious residential areas to the north and east, and an extensive system of recreational facilities to the south-west, encompassing parks, golf courses, tennis courts, and a sailing club.

The Rose Bay Centre has a strong urban village character, due in a large part to its neighbourhood scale, variety of retail and local service establishments, and friendly pedestrian ambience. Despite these attributes, the built form generally lacks cohesion due to the broad palette of materials used in buildings of different eras, and the varying architectural quality. A more distinctive building fabric has the potential to further consolidate the centre’s presence.

The centre is contained within a few blocks, but currently lacks a focus. Some of the most exceptional features of the area, such as the proximity of the harbour and numerous pocket parks, have little presence in the centre. There is the potential to improve access between the existing foreshore parks and the beach, allowing continuous waterfront access from Lyne Park in the west to Dumaresq Reserve in the east. There is also tremendous opportunity to visually connect Pannerong Reserve in the centre and Percival Park on the foreshore, by creating a square at the end of Newcastle Street, to make a unique and memorable focus for Rose Bay.

This chapter identifies the Core Area, Transition Area and Entrances (see Figure 3 Urban structure) within the Rose Bay Centre. This classification reinforces the existing urban structure, and enhances its complexity, providing opportunities for different buildings types and uses, in various parts of the centre.

**FIGURE 3** Urban structure



The Core lies between the intersections of New South Head Road with Dover Road and Newcastle Street, and reflects this historically significant route to Watsons Bay. It is the focus of retail activity, defined by buildings which abut the footpath and awnings above, which distinguish it from the surrounding leafy areas. Development in the Core should reinforce its more intense urban quality.

The Transition Areas lie outside the Core in the vicinity of the recreational areas and residential zones, and are an important buffer to these areas. They do not contain the same level of retail activity as the Core but provide residential and commercial uses. They are generally characterised by less continuous building frontage and a stronger landscape presence. The Transition Areas should provide a gradation in development intensity from the Core to the residential and recreational areas.

Entrances are the primary entry points to the centre along New South Head Road, Newcastle Street and Dover Road. Entrances should be more clearly defined to strengthen the centre's containment, enriching the contrast between this busy pedestrian area and its quieter environs.

---

## D6.4 Street character

The street is the primary organising element of urban structure. The street edge is the place where the public and private domains meet. By defining a particular vision for each street, public domain improvements and private development can be coordinated to produce a desired outcome.

This section of the chapter describes the desired future character of each street in the Rose Bay Centre, based on a synthesis of the public domain objectives set out in Section 6.1.3. The Rose Bay Centre Public Domain Improvements Plan should be used as a guide to works in the public domain, such as street tree planting, footpath design, street furniture and traffic devices. Applicants should also seek advice from Council's Technical Services Division.

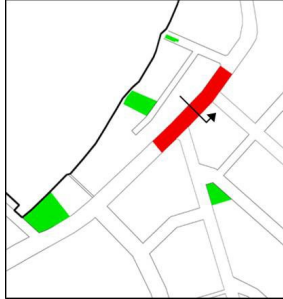
The following is provided for each street in the centre:

- ▶ street strategies, which briefly outline the urban design criteria for each street; and
- ▶ annotated street sections, which indicate the existing development context and illustrate the desired future character.

This information sets the context for development controls described in Section D6.5 and D6.6, and streetscape changes in the Public Domain Improvements Plan.

## D6.4.1 New South Head Road

### Core area

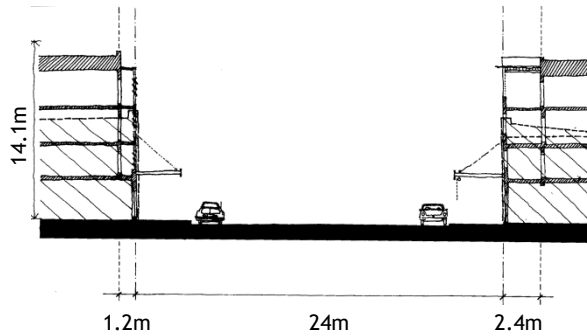


#### Strategy

- ▶ Identify and reinforce the core of the Rose Bay Centre, by encouraging retail activity, and enhancing its built edge urban quality.

#### North-western side

- Parapets encouraged
- Incorporate sound attenuation devices such as wintergardens
- Continuous awnings
- Build to the street alignment with glazed retail frontage at street level and commercial / residential above
- No vehicular crossings - vehicular access permitted at the rear

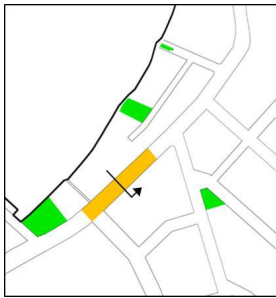


#### South-eastern side

- Build to the street alignment with masonry walls and loggias above street level
- Commercial/residential uses above street level
- Typical profile of existing buildings
- Glazed retail frontage at street level

### Transition area



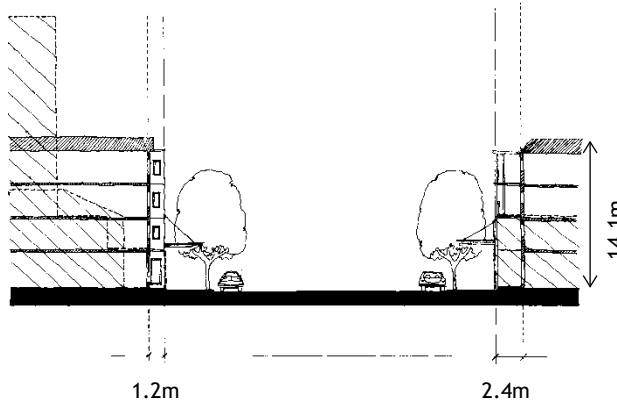


**Strategy**

- ▶ Create a transition between the Rose Bay Centre core and the recreational/landscape area towards Lyne Park, with a portion of street defined by street trees and a discontinuous wall of buildings on the harbour side.

**North-western side**

- Incorporate sound attenuation devices
- Typical profile of existing buildings (dashed outline)
- Minimise vehicular crossings

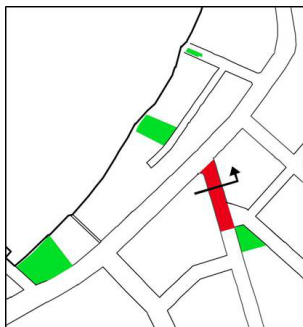


**South-eastern side**

- A variety of roof forms is encouraged
- Discontinuous awnings accommodate street tree planting and highlight building entries

**D6.4.2 Newcastle Street**

**Core area**

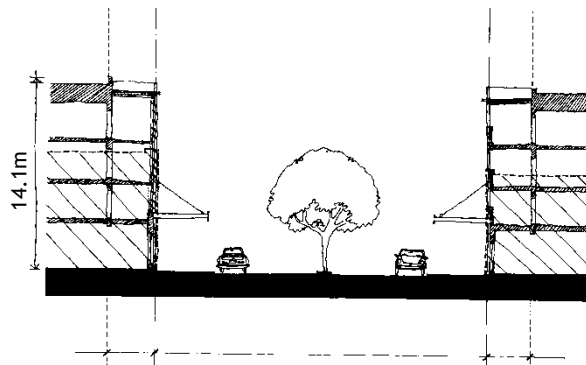


**Strategy**

- ▶ Reinforce the built street frontage and establish a connection between Pannerong Reserve and the harbour by improving the landscape quality in Newcastle Street.

**Western side**

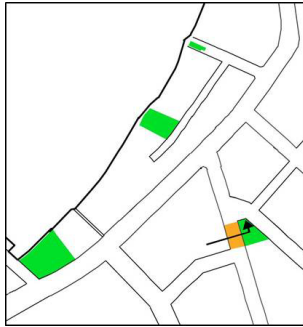
- Parapets encouraged
- Street trees in the median create an intimate scale of street
- Build to the street alignment with glazed retail frontage at street level



**Eastern side**

- Build to the street alignment with masonry walls and loggias above street level
- Continuous awnings
- Typical profile of existing buildings (dashed outline)
- No vehicular crossings - vehicular access permitted at the rear

**Transition area**

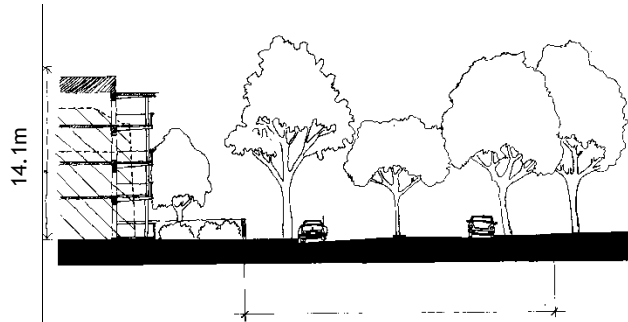


**Strategy**

- Create a transition opposite Pannerong Reserve to denote the residential area from the centre.

**Western side**

- A variety of roof forms is encouraged
- Typical profile of existing buildings
- Commercial/residential uses above street level
- Entry canopies allowed
- Commercial uses at street level
- Build to the existing building alignment with front gardens/courtyards at street level
- Minimise vehicular crossings



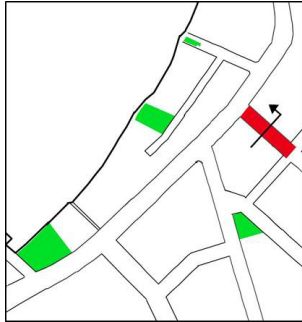
**Eastern side**

- Buildings encouraged to overlook the Pannerong Reserve
- Street trees in the median create an intimate scale of street

**FIGURE 4** View down Newcastle Street to New South Head Road



### D6.4.3 Dover Road



#### Strategy

- ▶ Create a distinctive framed urban shopping street, defined by retail frontage at street level, with buildings above set back on terraces above, to improve visibility to the Rose Bay Hotel.

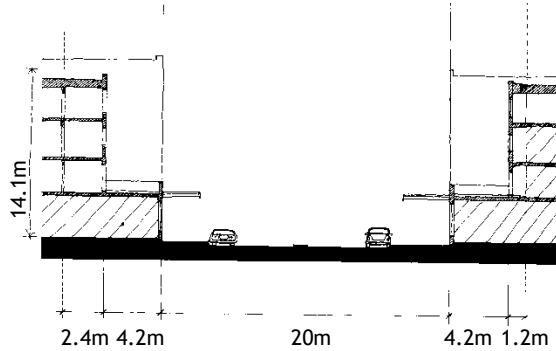
#### South-western side

Profile of the Rose Bay Hotel

Parapets encouraged

Build behind roof terraces above street level with masonry walls and loggias to enhance the amenity of development and increase the visibility of the Rose Bay Hotel

Continuous awnings



#### North-eastern side

Build to the street alignment with masonry walls and loggias above street level on the corner site only, to highlight the entrance to New South Head Road

Commercial/residential uses above street level

Build to the street alignment with glazed retail frontage at street level

No vehicular crossings – vehicular access permitted at the rear

### D6.4.4 Wilberforce car park edge

---

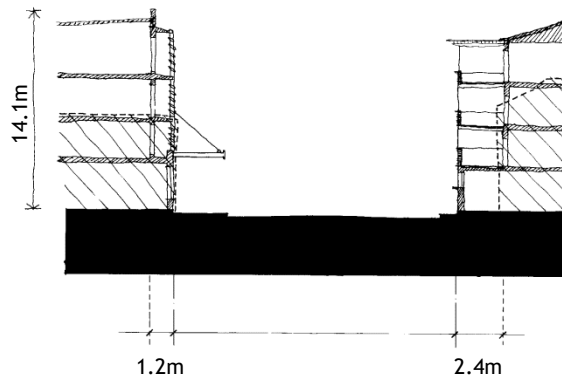


#### Strategy

- Define the southern edge of the centre and provide pedestrian access through the existing car park site.

#### North-western side

Encourage parapets  
Build to the street alignment with masonry walls and loggias above ground level  
Build to the boundary alignment with glazed retail frontage at ground level  
Typical profile of existing buildings

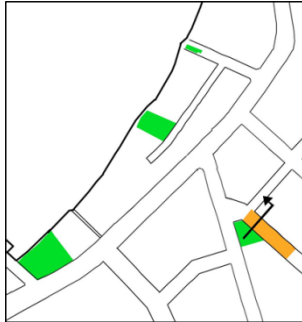


#### South-eastern side

A variety of roof forms is encouraged  
Commercial/residential uses above ground level  
Build to the street alignment with walls, loggias and balconies which overlook the street  
Commercial uses at ground level

### D6.4.5 Wilberforce Avenue

---



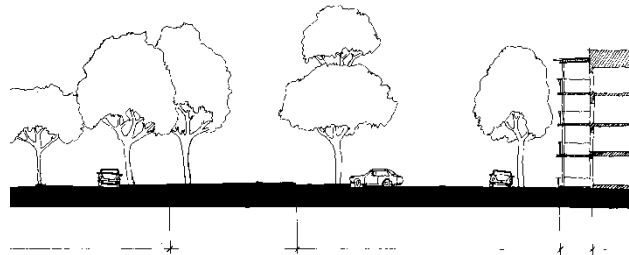
#### Strategy

- ▶ Reconfigure the street alignment to provide a memorable termination to Wilberforce Avenue maintaining the public open space.

#### South-western side

Supplement the existing tree planting

Angled parking along Pannerong Reserve



#### North-eastern side

For residential zoned land refer to Part B of this DCP

Buildings encouraged to overlook Pannerong Reserve

Build to the street alignment in the commercial zone

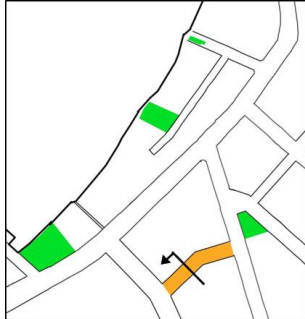
A variety of roof forms is encouraged

Commercial/residential uses above street level

Commercial uses at street level

Minimise vehicular crossings

### D6.4.6 Richmond Road



#### Strategy

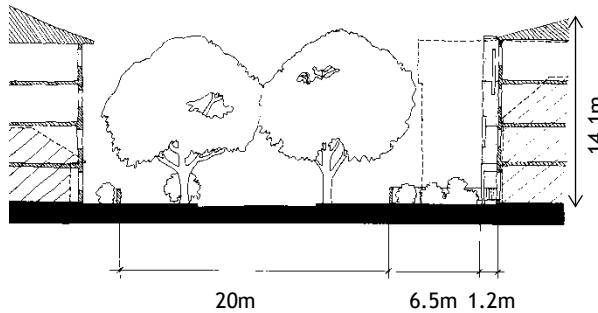
- ▶ Retain the unique character of this predominantly residential street on the periphery of the centre, defined by mature street trees and a discontinuous wall of buildings.

#### South-eastern side

Maintain the existing street trees

Typical profile of existing buildings

For residential zoned land refer to Part B of this DCP



#### North-western side

A variety of roof forms is encouraged

Encourage office and other non-retail commercial uses on the ground floor to provide a transition to nearby residential development.

Build walls with windows, loggias and balconies which overlook the street

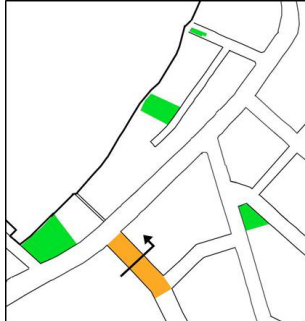
Build to the existing building line with front gardens/courtyards at street level

Minimise vehicular crossings

Build to the street alignment at the intersection with Newcastle Street to reinforce the corner

### D6.4.7 Norwich Road

---

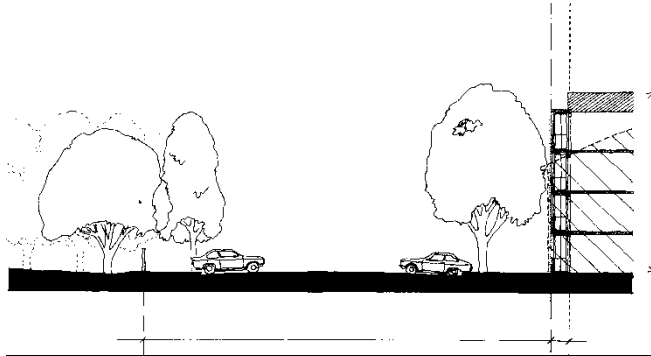


#### Strategy

- Create a defined edge, in terms of both landscape and built form definition, between the centre and the recreational/landscape area in the vicinity of Lyne Park and the Royal Sydney Golf Course.

#### South-western side

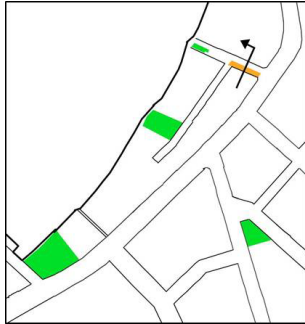
- Maintain the existing street trees
- Supplement the existing street tree planting
- New footpath



#### North-eastern side

- Build to the street alignment with windows, loggias and balconies which overlook the street
- Commercial/residential uses above street level
- Commercial uses at street level
- Typical profile of existing buildings
- Minimise vehicular crossings

### D6.4.8 Caledonian Road



#### Strategy

- ▶ Retain the unique character of this landscaped residential street to the harbour.

#### South side

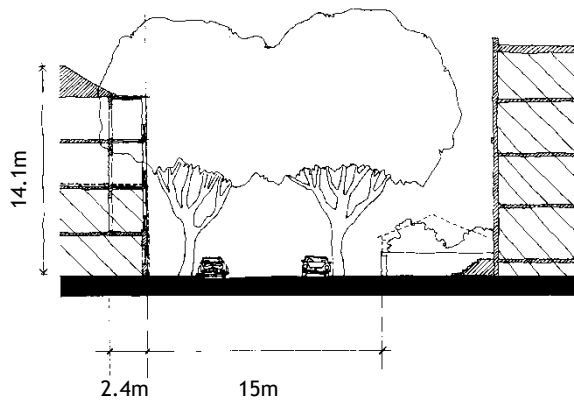
Maintain the existing street trees

Build to the street alignment with windows, loggias and balconies which overlook the street

Commercial/residential uses above street level

Access to street level retail frontage is not permitted

Minimise vehicular crossings

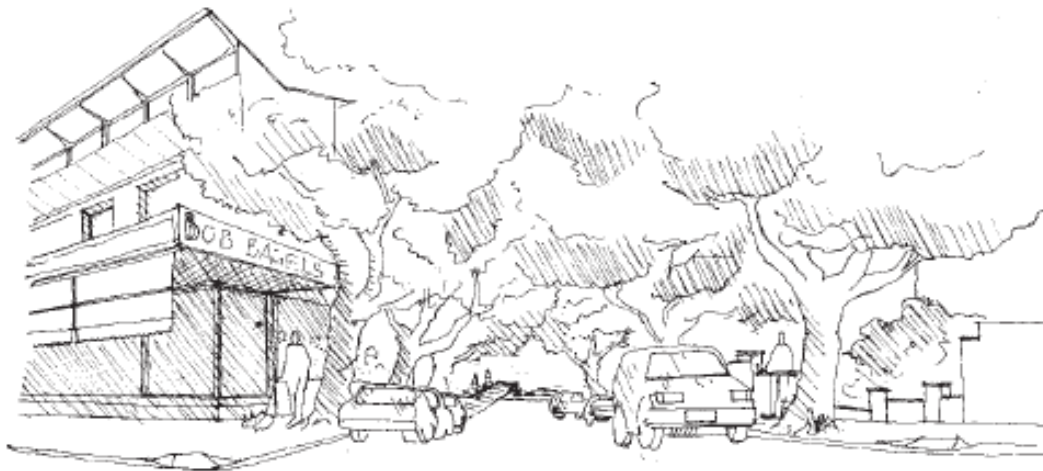


#### North side

Typical profile of existing buildings

For residential zoned land refer to Part B of this DCP

**FIGURE 5** View down Caledonian Road looking towards the harbour





### D6.4.9 Collins Avenue



#### Strategy

- ▶ Create a small urban street defined by private tree plantings, strong garden walls, and clearly defined entries on the harbour side, and a continuous and articulated wall of buildings on the south side.

#### South-eastern side

A variety of roof forms is encouraged

Build to the street alignment with walls, windows, loggias, balconies and terraces above street level

Protect privacy of residential neighbours opposite

Protect privacy of residential neighbours opposite

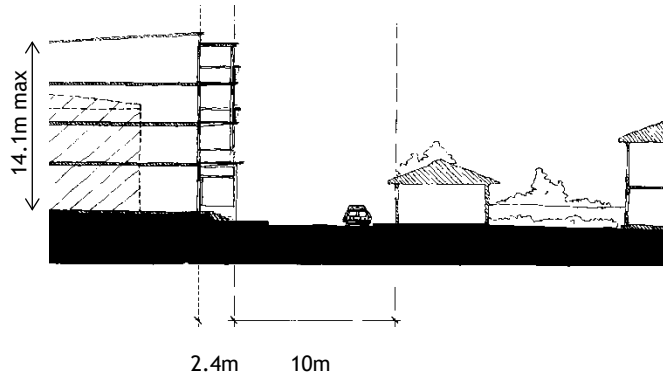
Typical profile of existing buildings

Commercial/residential uses above street level

Build to the street alignment with glazed retail frontage at street level

Widen existing footpath

Minimise vehicular crossings



#### North-western side

For residential zoned land refer to Part B of this DCP

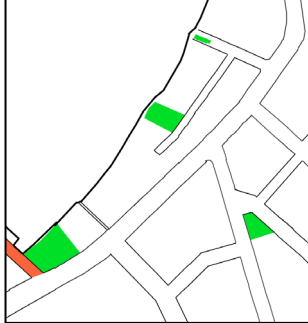
**FIGURE 6** View down Collins Avenue from Caledonian Road



---

## D6.4.10 Vickery Avenue

---



### Strategy

- ▶ Strengthen the landscape quality of the street as an entry to Lyne Park with a strong visual connection to the harbour, and link to Tingira Reserve.

---

## D6.5 Built form envelopes: control drawings

### D6.5.1 Urban form methodology

---

This section contains control drawings which show building envelopes for every site in the Rose Bay Centre. The envelopes have been tailored to each site, taking into consideration its particular characteristics.

These include:

- ▶ its relationship to the public domain- whether it is located in the Core or a Transition Area, or adjacent to a public park or square;
- ▶ the desired future character of the street in which the site is situated;
- ▶ its size and orientation;
- ▶ the significance of existing buildings and landscape;
- ▶ its optimum development potential; and
- ▶ the potential of adjoining private properties.




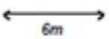



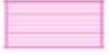





This Urban Form Methodology defines a physical outcome for the centre, whilst encouraging innovative architectural design within the building envelopes given. It provides a greater certainty of outcome for Council, community and site owners.

Controls for the ground floor and upper floor levels differ. At street level the integration of retail and commercial uses, gardens areas, vehicular access and street awnings, are the primary needs to be considered. Upper floor level envelopes are designed to facilitate quality residential and commercial development. For this reason there are two control drawings for each urban block in the Rose Bay Centre, illustrating the ground floor and upper floor level envelopes for every site.

The control drawings in this section should be read in conjunction with Section D6.6 which provides further explanation of the envelopes, and introduces other relevant guidelines and controls.

## D6.5.2 Explanatory legend

The control drawings incorporate the following graphic symbols:

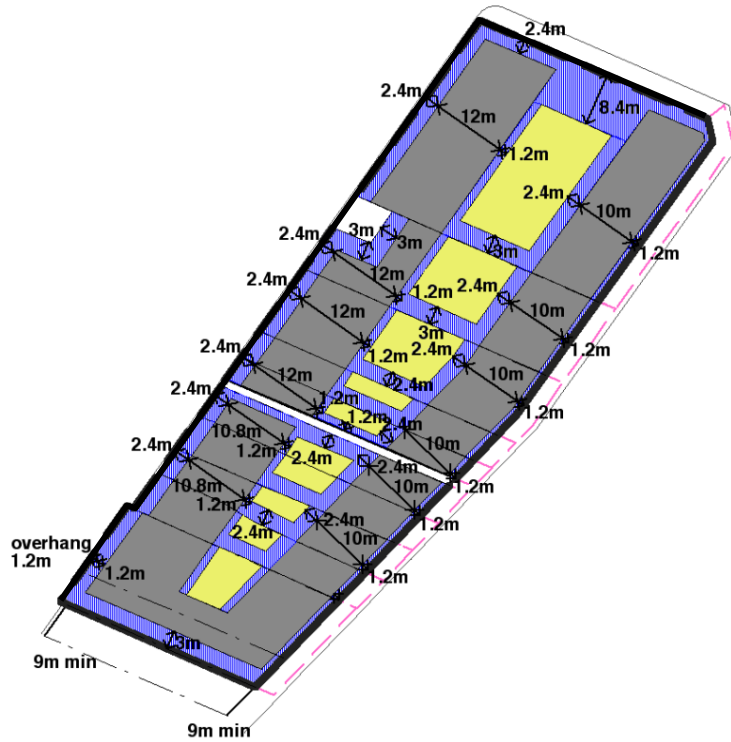
<b>BUILDING ENVELOPE</b>	
	100% of this area per floor may be built on
	50% of this area per floor may be built on
	PREFERRED BUILDING LINE
	Maximum building zone depths or setbacks Where side setbacks are indicated assume 1m unless otherwise stated
<b>AREA FOR ARTICULATION</b>	
	
<b>ROOF TERRACE</b>	
	
<b>AWNINGS</b>	
	Continuous
	Discontinuous
	Awning to ground floor level below
	PREFERRED VEHICULAR ACCESS FRONTAGE
	PREFERRED PEDESTRIAN ACCESS FRONTAGE
<b>DEEP SOIL LANDSCAPED AREA</b>	
	Minimum percentage of deep soil landscaped area
<b>COLONNADE ZONE</b>	
	

### D6.5.3 Rose Bay Centre urban form

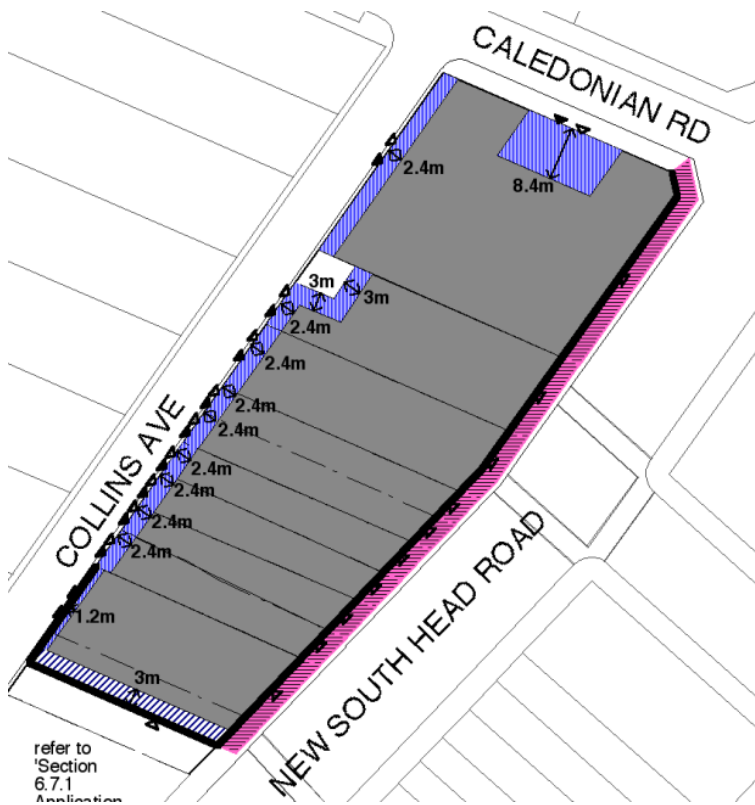


### D6.5.4 Control drawing 1

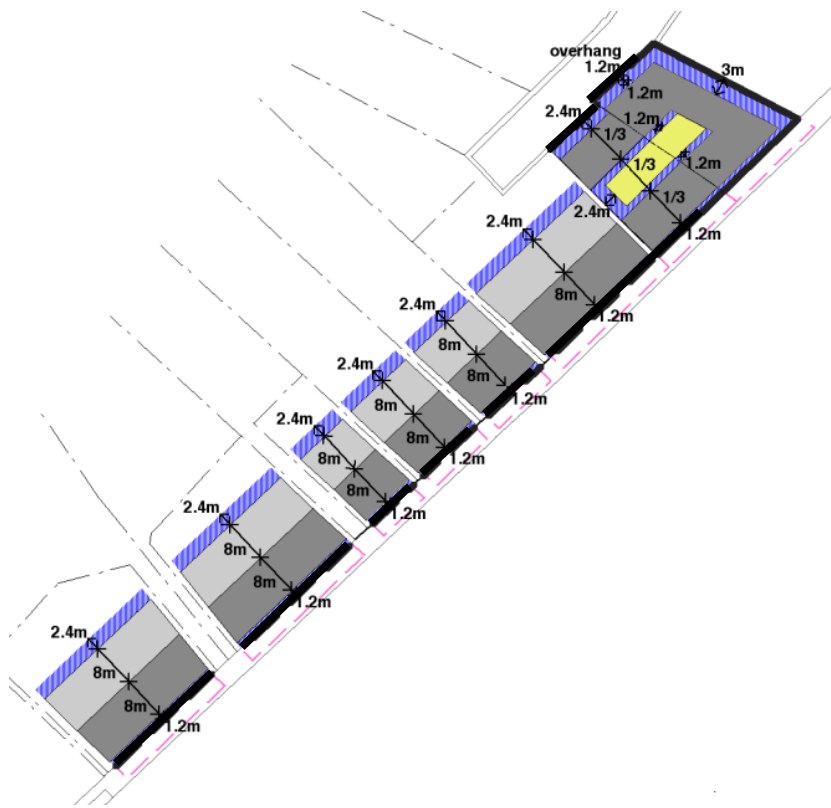
#### Upper floor level controls New South Head Road (north) / Collins Avenue



#### Ground floor level controls



### D6.5.5 Control drawing 2



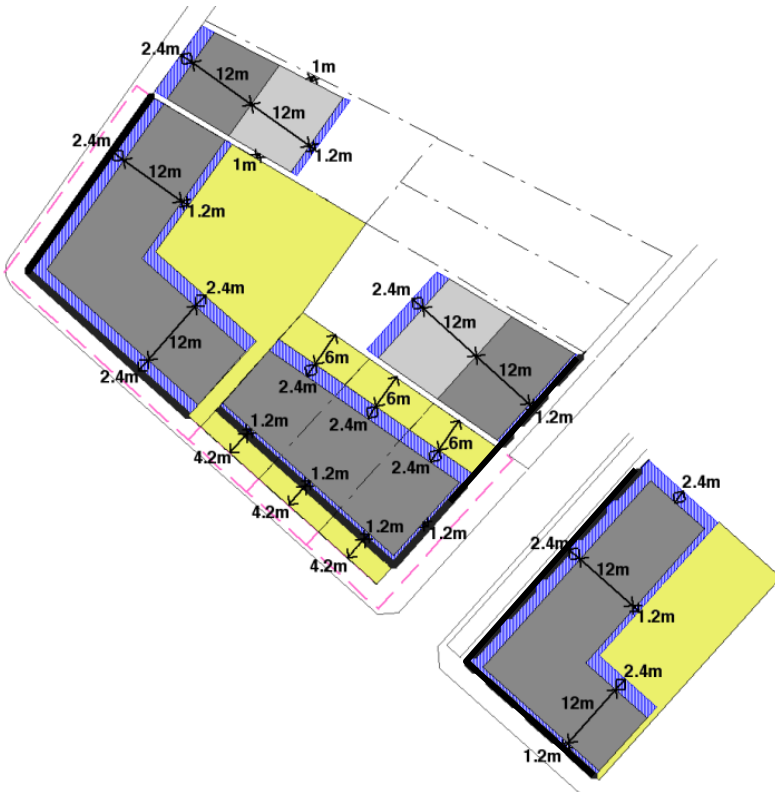
**Upper floor level controls**  
New South Head Road  
(south) between Norwich  
Road and Newcastle Street



**Ground floor level controls**

### D6.5.6 Control drawing 3

**Upper floor level controls**  
New South Head Road /  
Dover Road / Ian Street

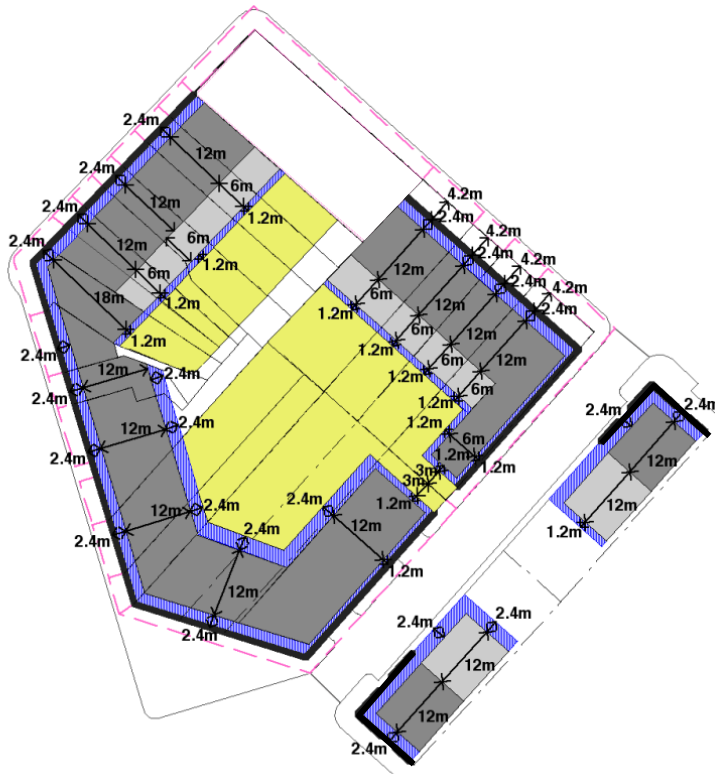


**Ground floor level controls**





### D6.5.7 Control drawing 4



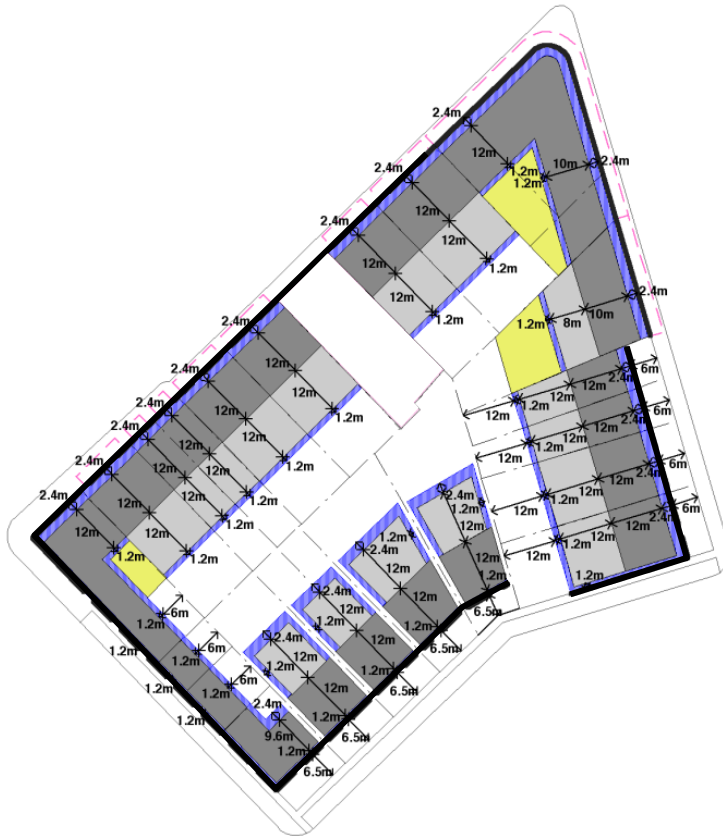
**Upper floor level controls**  
New South Head Road  
(south) / Dover Road /  
Newcastle Street  
Wilberforce car park edge



**Ground floor level controls**

### D6.5.8 Control drawing 5

**Upper floor level controls**  
New South Head Road (south) / Dover Road / Newcastle Street



**Ground floor level controls**



---

## D6.6 Built form: Development objectives and controls

### D6.6.1 General format

---

This section contains the development controls for identified building and site elements in the Rose Bay Centre which constitute its built form. It provides further explanation of the control drawings contained in Section D6.5 and introduces new controls not described in those drawings.

The following format is used:

#### Introduction

For most policies there is an introduction which explains the need and importance of including that particular element.

#### Objectives

The objectives define Council's intention. They relate to the aims and objectives in Section D6.3 Urban structure, and the desired future character outlined in Section D6.4 Street character.

#### Controls

The controls establish the means of achieving the objectives. The controls in this chapter are site specific. This means they have been tailored to each site taking into consideration both the private built form and public spaces, to define a desired future outcome.

This section of the DCP must be read in conjunction with the control drawings which illustrate the site-specific controls. Diagrams are incorporated to assist interpretation.

Not all objectives and controls will be relevant to every development. The applicant must nominate any guidelines and controls which they considered irrelevant, and justify that opinion.

---

## D6.6.2 Use

---

The distinctive mix of small scale shops, restaurants and local services in the Rose Bay Centre creates a friendly street environment, and caters well for the daily needs of the centre's users. Continuous ground level retail frontage offers the benefits of safety, commercial activity and street life. The provision of commercial uses and housing on upper levels makes a significant contribution to the village character, providing street surveillance and activity in the centre outside business hours.

### Objectives

- O1 Enhance the village character of the Rose Bay Centre by encouraging mixed use commercial and residential development.
- O2 Create active street frontages in the Rose Bay Centre by locating retail, commercial and community uses at street level.
- O3 Discourage large scale retail establishments, by limiting the frontage width of individual retail tenancies.

### Controls

- C1 Design for a mix of uses within buildings.
- C2 Design adaptable and durable buildings, spaces and places.
- C3 Design for retail, commercial and community uses at ground floor.
- C4 Access to residential uses should not occupy more than 20% of a site's frontage.
- C5 The maximum retail frontage for individual tenancies is 15m.

### FIGURE 7 Building use

Retain the range and intensity of existing retail uses in Rose Bay by limiting the width of retail frontages



---

## D6.6.3 Urban character

---

### 6.6.3.1 Building envelopes

The building envelope sets the position of the building on the site, and is described on the control drawings. Buildings in the Rose Bay Core are generally row buildings, with development concentrated to the street frontage. They have no side setbacks at the street frontage so clearly define the edges of the street. Buildings are massed away from the centre of blocks, encouraging solar access, natural ventilation and privacy.

Buildings in the Transition Areas are also concentrated towards the street and are built on or close to the street alignment, accommodating private gardens at the rear in many places. Contiguous front gardens in some areas such as Richmond Road make a significant contribution to the streetscape quality.

The building envelopes in Sections 6.5.2-6.5.8 have been designed to work in conjunction with the height and floor space ratio (FSR) controls in Woollahra LEP 2014.

Note: The maximum FSR for the centre is generally 2:1. The maximum height of buildings is generally 14.1m (4 storeys). Bonus height and FSR applies to 682-696 New South Head Road, subject to the provision of the Rose Bay Public Square (see Section 6.6.10.1).

### Objectives

- O1 Enhance the urban village character of the Rose Bay centre by encouraging a coherent street character with consistent building types built to, or parallel to the street alignment.
- O2 Take advantage of the centre's unique assets by orientating buildings to address parks and the harbour where possible.
- O3 Retain and promote the pattern of perimeter block development to ensure a high level of amenity to all new development.
- O4 Create exterior garden and courtyard spaces.
- O5 Accommodate commercial uses by allowing deep building footprints at the ground floor level only.

### Controls

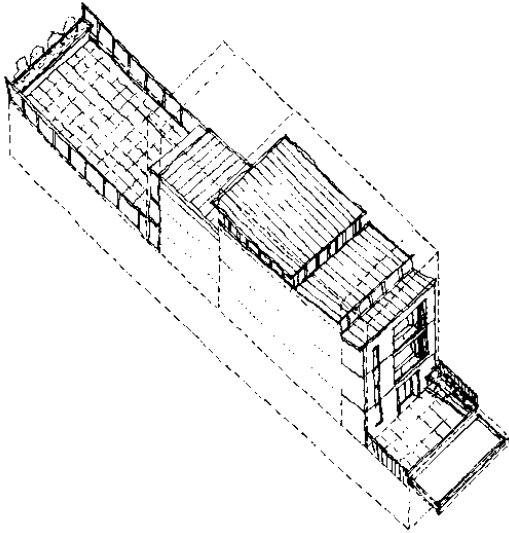
- C1 Development may only occur within the building envelopes shown on the control drawings (see Sections 6.5.2-6.5.8).
  - C2 Well-designed buildings which achieve the maximum height are encouraged, to enhance the definition of the street edge.
  - C3 The maximum permissible building depth above ground level is 12m.
  - C4 A minimum floor to ceiling height of 2.7m for habitable spaces applies in the centre to provide quality internal environments and facilitate future adaptability of uses.
-

C5 The minimum floor to floor heights for the Rose Bay Centre comply with the table below.

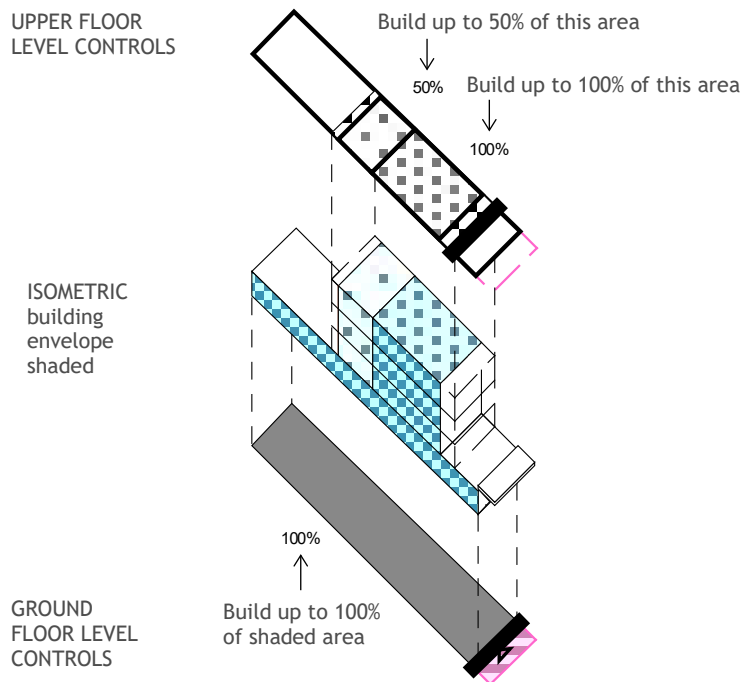
Level	Use	Height
Ground floor	Retail <sup>1</sup>	4m
Levels 2	Commercial office or residential	3.4m
Levels 3-5	Residential	3.1m

<sup>1</sup> Applicants may choose to vary storey height using 3.7m height for ground floor and Level 2 to create double storey spaces with a combined floor to floor height of 7.4m.

**FIGURE 8** Building envelope – Potential architectural resolution within a building envelope



**FIGURE 9** Three dimensional controls – Highlighting the building envelope



### 6.6.3.2 Setbacks

The dominant building type in the Core is the party wall building with zero front and side setbacks.

In Transition Areas the architectural typology is more varied and includes free-standing buildings with relatively small side setbacks. The prevalent building alignment is generally close to the street, accommodating small front gardens and entry porches in some places.

Corner buildings throughout the centre are built to both street alignments, providing strong corner definition.

### Objectives

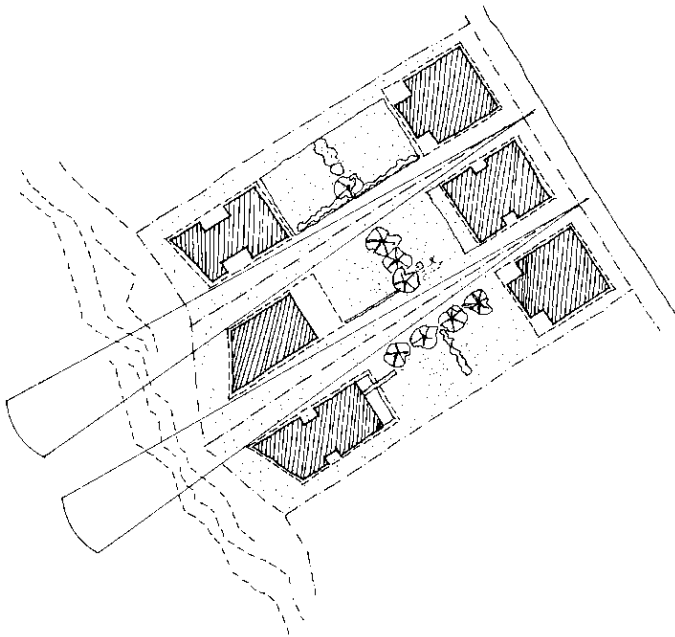
- O1 Retain and enhance the predominant pattern of row buildings only in the Rose Bay Core, and row and free-standing buildings in the Transition Areas.

### Controls

- C1 Building alignment should comply with the building lines shown on the control drawings (see Sections 6.5.2-6.5.8)
- C2 Primary door and window openings in living areas should be located towards the street and/or rear garden to protect privacy and encourage integrated private open spaces. Living areas with primary openings facing the side boundary should be avoided.

- 
- C3 The design of corner buildings should be considered in relation to street geometry, topography, sight lines and the design of skyline elements.
- C4 Front setbacks are identified as building lines on the control drawings (see Sections 6.5.2-6.5.8). Front setbacks should:
- define a coherent alignment to the public domain;
  - accentuate significant street corners; and
  - accommodate contiguous front gardens in identified areas.
- C5 Side setbacks should:
- protect privacy to adjoining buildings;
  - protect access to natural light and ventilation;
  - provide pedestrian access to the rear of buildings;
  - facilitate views from the public domain to the harbour where possible; and
  - allow stormwater to flow towards the harbour.
- C6 Rear setbacks should:
- provide consolidated landscaped areas at the centre of blocks adjoining residential areas;
  - facilitate natural infiltration of stormwater;
  - protect privacy to adjoining buildings and gardens; and
  - facilitate solar access.

**FIGURE 10** Side setbacks – Facilitate views from the public domain to the harbour





### 6.6.3.3 Building articulation

Building articulation refers to the three dimensional modelling of a building. The control drawings indicate the area for building articulation on a site by site basis (see Sections 6.5.2-6.5.8).

The Street Façade Articulation Zone (SFAZ) establishes the relationship between a building and the street, through the use of entry porches, loggias, balconies, bay windows and the like. Building facades can be articulated to create a strong street address, and enrich the character of the street. The Dover Road frontage of the Rose Bay Hotel in particular, is an excellent example of a well-articulated facade.

Building articulation should respond to environmental conditions such as orientation, noise, breezes, privacy and views, through the use of appropriate sun shading devices, noise barriers, privacy screens, and the careful location of balconies, terraces and loggias. At the rear of a building, articulation should enhance the relationship between the interior and the garden.

The building line determines the position of the facade wall. In certain areas of Rose Bay the building line has been setback from the street alignment. Compliance with this control is required to ensure that the façade aligns with the neighbours at the side boundary. The SFAZ is positioned behind this building line.

The SFAZ is occupied by two types of space:

- External:
  - open balconies;
  - void not occupied by built form; and
  - recessed balconies counted in proportion to the amount of the façade they are open to.
- Internal:
  - habitable rooms;
  - bay windows;
  - enclosed balconies; and
  - wintergardens.

### Objectives

- 01 Promote buildings of articulated design and massing, with building facades that contribute to the character of the street, and provide usable private external spaces.
- 02 Encourage buildings to respond to environmental conditions, and promote energy efficient design principles.
- 03 Utilise building articulation elements of appropriate scale to their use and context.
- 04 Reinforce the development pattern of buildings on the street alignment in the Core.
- 05 Reinforce the more open streetscape quality in the Transition Areas.

## Controls

- C1 To achieve high quality architectural resolution on frontages that address a street, the following percentages of internal and external space should be incorporated with the composition of the building for all floors above ground level.

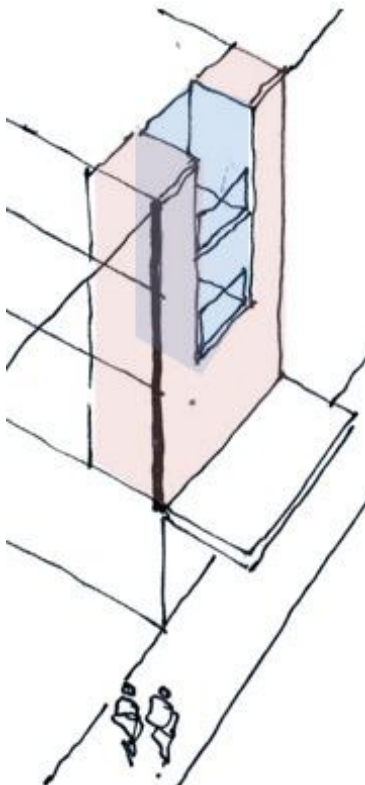
Note: The use of a palette of articulation elements is recommended to achieve high quality architectural resolution.

### Arrangement ONE - Street Façade Articulation of buildings in the Core area:

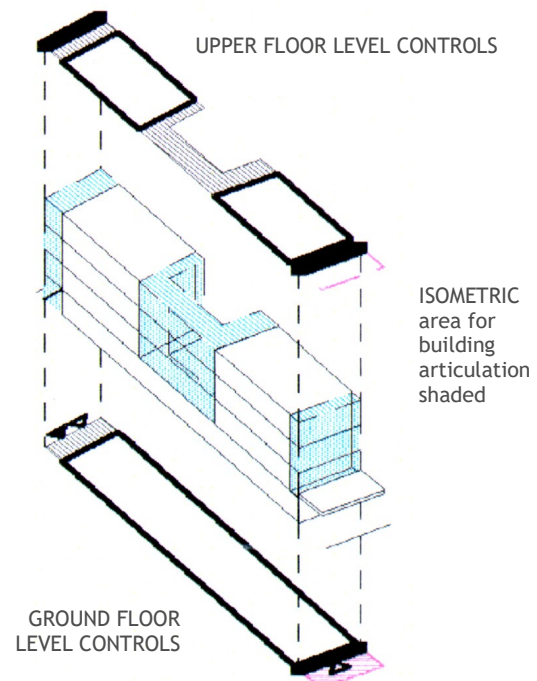
- Buildings in the core area must provide 80% internal space and 20% external space in the SFAZ.
- Where the control diagrams indicate that articulation on parts of the building envelope that are not in the SFAZ, the mix of internal and external space is discretionary.

Note: This variation requires that the majority of the SFAZ is expressed as solid producing a more building suited to the activity associated with the business core.

**FIGURE 11** Street façade articulation in the Core Area – refer to Articulation Arrangement ONE



**FIGURE 12** Three dimensional controls – Highlighting the area for building articulation in the Core

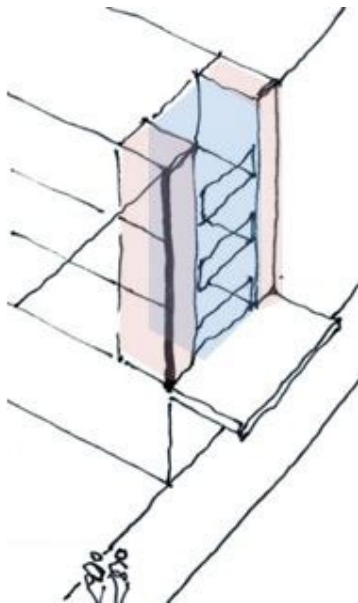


**Arrangement TWO - Street Façade Articulation of buildings in the Transition Area:**

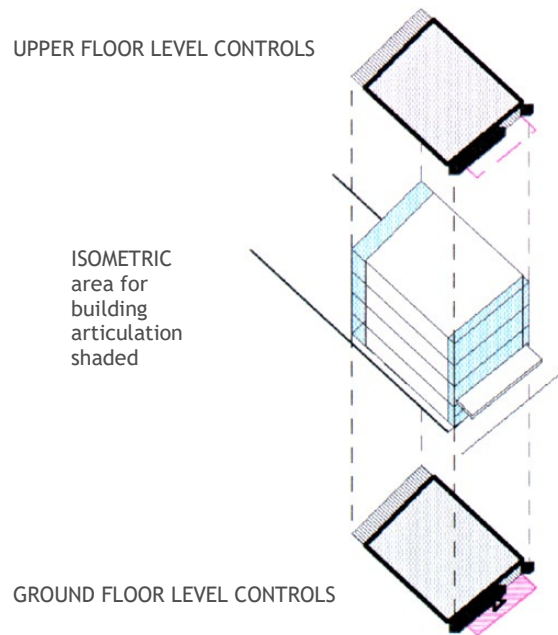
- a) Buildings in the Transition Area must provide 30% internal space and 70% external space in the SFAZ.
- b) Buildings on New South Head Road should be designed to reduce amenity impacts from traffic noise. Bedrooms should be located away from noise sources.
- c) Private open space elements such as balconies, should be predominantly north, east and west facing, and should be designed to ensure visual and acoustic privacy of occupants and neighbours.
- d) Where the control diagrams indicate that articulation on parts of the building envelope that are not in the SFAZ, the mix of internal and external space is discretionary.

Note: This variation requires a far more open façade compared to the core with greater potential for larger residential balconies.

**FIGURE 13** Street façade articulation in the Transition Area – refer to Articulation Arrangement TWO



**FIGURE 14** Three dimensional controls – Highlighting the area for building articulation in the Transition Area



### 6.6.3.4 Heritage and conservation

Council supports the conservation of the rich mixture of buildings, parks and places of special significance within the Municipality. Woollahra LEP 2014 contains various controls on the conservation of items and areas of environmental and heritage significance. The LEP also contains incentives for developments which include the conservation of heritage items.

The Rose Bay Hotel, the former Rose Bay Post Office and two pines in Vickery Avenue are the only listed heritage items in the Rose Bay Centre. The Rose Bay Centre Urban Design Study 1998 identified an additional five character buildings which are shown in Figure 16. These buildings have high streetscape value because of their strong architectural character and the way in which they address the street. There are no heritage conservation areas in the Rose Bay Centre.

The grove of paperbarks adjoining the west side of Norwich Road is heritage listed and included on the significant tree register. The paperbarks contribute to the streetscape of Norwich Road by providing a soft edge and afternoon shade. Other tree groves which make a contribution to the streetscape are the bushbox on Richmond Road and figs on Caledonian Road. These two groves are on both sides of the road and form a united canopy shading the road and footpaths.

#### Objectives

- O1 Protect and enhance items of environmental and heritage significance and character buildings (see Figure 16 Character buildings).
- O2 All new developments and works to existing developments are to be designed to be compatible with the heritage significance of listed heritage items and nominated character buildings.

#### Controls

- C1 Development proposals on sites containing heritage items must retain heritage significance.
- C2 Development proposals on sites containing character buildings or heritage items must demonstrate that the architectural and streetscape value of the building would be retained or enhanced by the proposal.
- C3 Development to a character building or heritage item is to respect the building and complement and enhance the key characteristics of the building including:
  - a) street edge definition;
  - b) its material, detailing and character;
  - c) its holistic building character related to articulation, massing, and patterns and distribution of wall opening.

Note: Where a development involves a heritage item, a statement of heritage impact must be lodged with a development application. That statement must set out the heritage significance of the place and the effect the proposed works will have on the significance of the heritage item.

FIGURE 15 Rose Bay Hotel



FIGURE 16 Character buildings



---

### 6.6.3.5 Architectural resolution

Buildings in the Rose Bay Centre represent a cross section of 20th century architecture, with no period predominating, and are of varied quality. High quality architectural resolution can help to define a local identity.

#### Objectives

- 01 Promote high quality architectural design throughout the Rose Bay Centre to create a desirable living and working environment.
- 02 Encourage a more coherent streetscape.
- 03 Minimise the negative impacts of glare and reflectivity on adjoining public and private properties.
- 04 To ensure that development enhances the visual quality and identity of the centre through well considered design, high quality materials and facade colours that do not dominate the street.

#### Controls

- C1 A clear street address to each building should be provided. Pedestrian entries should be well defined.
  - C2 Vehicular entries should be discrete and minimise conflicts with pedestrians.
  - C3 Materials which are compatible with the existing development context, such as red face brick and rendered masonry, should be encouraged in street facade design.
  - C4 The colour of the building facade is not intrusive or unreasonably dominant within the streetscape, and is compatible with the character of the centre. Exterior colours should be appropriate to the context, and should not draw undue attention to the building. The external painting of a building in bright colours, corporate colours or fluorescent colours should be avoided. Any individual business branding and identity in external painting and colour schemes is to be subordinate to the main colour schemes in the street. (Also refer to Part E of this DCP, Chapter E7 Signage, When external painting of a building constitutes a wall sign).
  - C5 New buildings and facades do not result in glare that causes discomfort or threatens safety of pedestrians or drivers.  
  
Note: A reflectivity report that analyses the potential glare from the proposed new development on pedestrians or motorists may be required.
  - C6 Extensive areas of unprotected glazing are not permitted.
  - C7 Predominantly glazed shopfronts are to be provided to ground floor retail areas.
  - C8 Street corners are to be strengthened by massing and building articulation.
  - C9 Roller shutters to shopfronts are not permitted.
-

- C10 The design of window and balcony openings should take into account the streetscape, heritage items, privacy, orientation and outlook.
- C11 Blank party walls are to be avoided.
- C12 Facades are to be richly articulated and should express the different levels of the building and/or its functions.
- C13 Commercial space should be designed to permit maximum flexibility for future uses.
- C14 All rooms above ground floor level, including kitchens and bathrooms, are to have windows/skylights wherever possible.
- C15 The residential component of buildings must contain a variety of apartment sizes and layouts.

**FIGURE 17** Facades – Richly articulated with deep modelling and shadows



#### **6.6.3.6 Roof design**

The Rose Bay Centre Core is characterised by a predominance of buildings with articulated parapets, which contribute to its urban quality.

Roof forms vary with building type and architectural style in the Transition Areas, and include hips, gables, flat roofs and parapets.

#### **Objectives**

- O1 Promote design that contributes to the definition of the Core.
- O2 Encourage roof design to create a distinctive silhouette to buildings.

## Controls

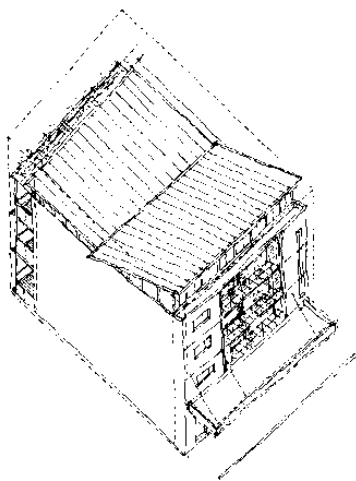
- C1 The use of parapets is encouraged in the Core.
- C2 The profile and silhouette of parapets, eaves and roof top elements must be considered in roof design.
- C3 Where pitched roofs are proposed, the angle of the pitch should be compatible with the existing development context.
- C4 Roof design should minimise building bulk and overshadowing.
- C5 Roof terraces are encouraged (see detailed provisions in Section 6.6.5.2 Above ground open space).
- C6 Air conditioning plant and equipment must be concealed from the exterior and be within the building. When roof plant is proposed it must be integrated with the design of the roof and the composition of the building and not be readily visible from the public domain.

**FIGURE 18** Roof design – Pitched roofs integrated with broken parapet lines in the Core



**FIGURE 19** Roof design – Roof forms must be contained within the building envelope.

Varying roof forms including hips, gables, flat roofs and parapets are encouraged in the Transition Areas





### 6.6.3.7 Awnings

Relatively continuous awnings provide wet weather protection and shade to shoppers in the busy Core. Awnings in the Transition Areas are more varied and less continuous, and are often used to highlight building entrances.

#### Objectives

##### Core

- O1 Retain and supplement the existing awnings to provide continuous and coherent awning cover along footpaths.

##### Transition Areas

- O2 Retain and supplement the existing awnings to provide discontinuous awning cover along footpaths to accommodate new street tree planting.

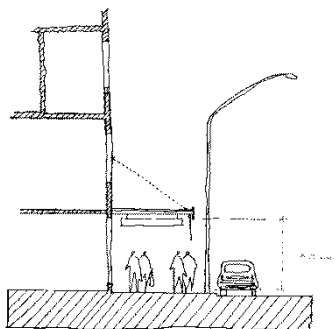
#### Controls

##### Core

- C1 Development must provide continuous awnings to street frontages as indicated on the control drawings. Awning design should be suspended steel box section type with a minimum soffit height of 3.2m. Awning height should provide continuity with adjoining properties.
- C2 Canvas blinds along the outer edge of awnings may be used to provide sun shading to the east and west facades. These blinds must not carry signage or advertising.

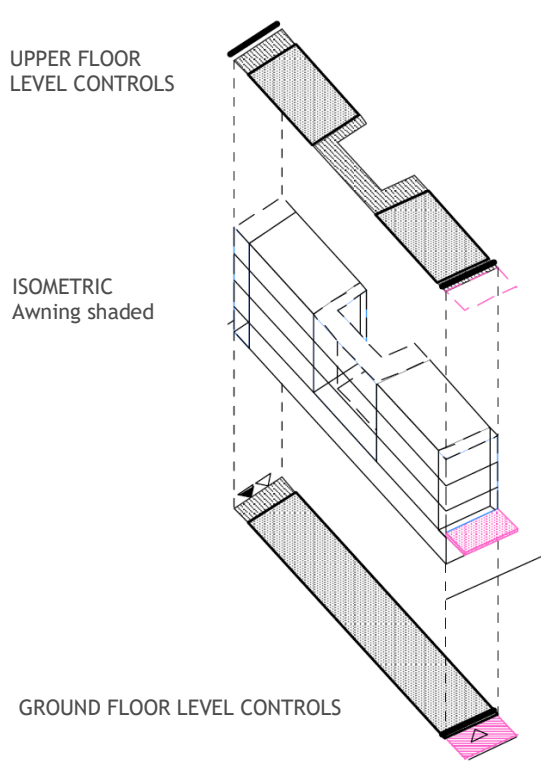
##### Transition Areas

- C3 Development must provide discontinuous awnings where indicated on the control drawings. These awnings should provide cover to building entrances.
- C4 The provision of under awning lighting is encouraged. Under awning lighting may be recessed into the soffit of the awning or wall mounted on the building.



**FIGURE 20** Awning design

Suspended steel box section type with a minimum soffit height of 3.2m

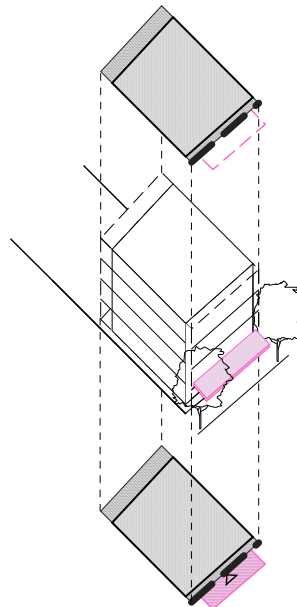


**FIGURE 21** Three dimensional controls – Core area  
Highlighting the continuous awnings

UPPER FLOOR LEVEL CONTROLS

ISOMETRIC  
Awning shaded

GROUND FLOOR LEVEL CONTROLS



**FIGURE 22** Three dimensional controls –  
Transition area

Highlighting the discontinuous awning zone which accommodates street tree planting.

### 6.6.3.8 Public art

Public art in developments can enhance the experience of the occupants and contribute to a sense of place.

#### Objectives

- O1 To require the provision of public art in significant or large-scale developments.
- O2 To integrate the public art so it is a cohesive part of the building design, interior or landscaping of the development.
- O3 To design and locate the public art so that the aesthetics and amenity of the art can be appreciated by people within and outside the development.
- O4 To enhance the experience of the occupants of the development and their relationship with the development through public art.
- O5 To use public art to facilitate a connectedness between the development and the public domain.

#### Controls

- C1 Development with a capital investment value of \$15M or more includes public art.
- C2 The public art is installed on the development site or in the immediate vicinity of the site.
- C3 The public art is located so that it is not unreasonably inaccessible or obscured by a building element which makes it impossible to see in full by the building occupants and the general public.
- C4 The public art is prepared and undertaken in accordance with the Woollahra Public Art Guidelines for Developers.

## D6.6.4 Visual and acoustic privacy

---

Privacy is an important consideration in relation to the residential component of the Rose Bay Centre and neighbours adjacent to the centre, as it is a major determinant of environmental amenity.

#### Objectives

- O1 Ensure adequate visual and acoustic privacy to residential apartments in the centre and private open spaces.
- O2 Protect the privacy of adjacent residential neighbours.

## Controls

### Visual privacy

- C1 Visual privacy is to be protected by providing adequate distance between opposite windows of neighbouring dwellings where direct view is not restricted by screening or planting (see Figure 23 Visual and acoustic privacy).
- C2 Main living spaces are to be oriented to the street or rear garden to avoid overlooking between neighbouring properties. Living areas with primary openings facing the side boundary should be avoided.

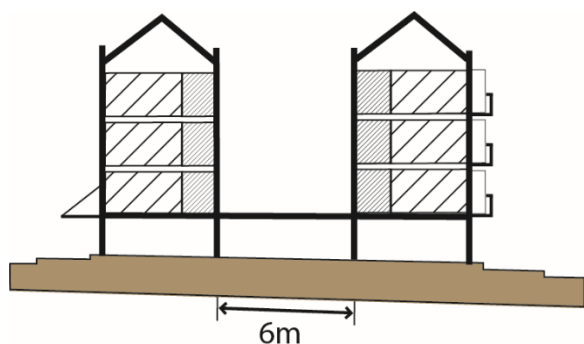
### Acoustic privacy

- C3 Buildings are to be sited to minimise the transmission of external noise to other buildings on the site and on adjacent land.
- C4 The internal layout of rooms, courtyards, terraces and balconies, the use of openings, screens and blade walls, and choice of materials, should be designed to minimise the transmission of noise externally.
- C5 Bedroom areas are separated by way of barriers or distance, from on-site noise sources such as active recreation areas, car parks, vehicle accessways and service equipment areas.
- C6 Restaurants and cafes should be designed to minimise the impact of noise associated with late night operation, on nearby residents.
- C7 Rear courtyards would only be permitted for restaurant use if Council is satisfied that the hours of operation would not have an unreasonable impact on residential amenity
- C8 Noise impact associated with goods delivery and garbage collection, particularly early morning, should be minimised.

Note: Council may require a Noise Impact Assessment Report to accompany a Development Application.

## FIGURE 23 Visual and acoustic privacy

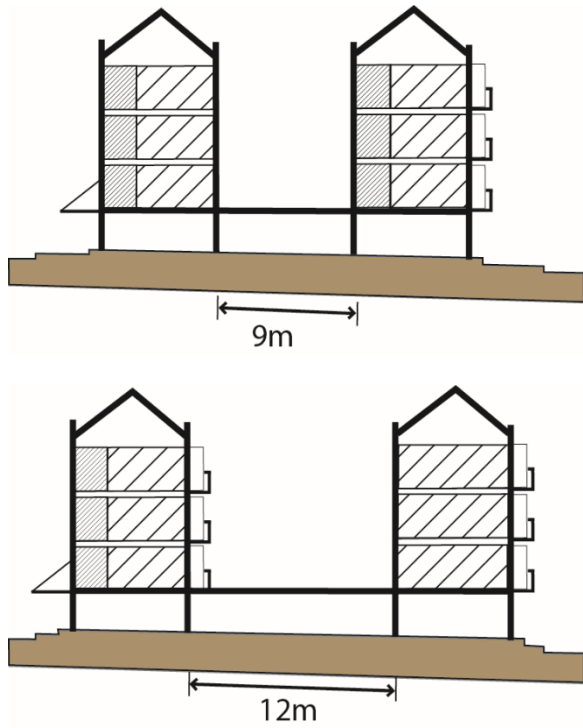
### Minimum distances for visual and acoustic privacy



#### Habitable room

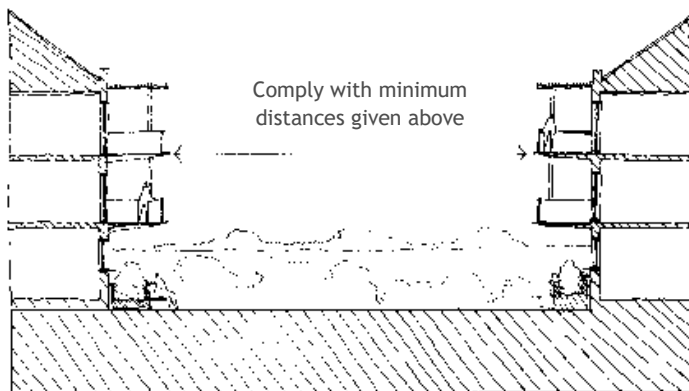
A room used for normal domestic activities that includes: a bedroom, living room, lounge room, music room, television room, dining room, sewing room, study, playroom, sunroom and kitchen.

#### Non-habitable room

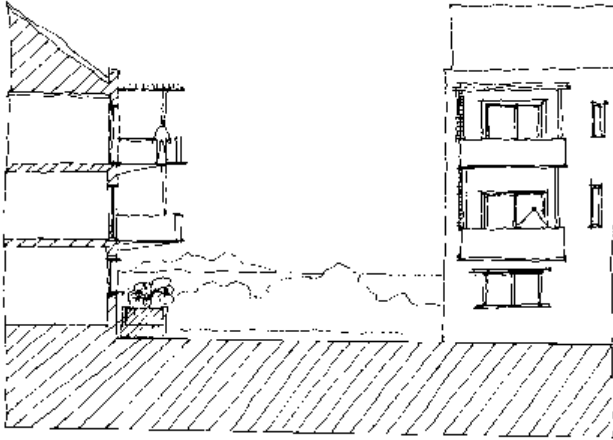


A room of a specialised service nature occupied neither frequently nor for extended periods, including a bathroom, laundry, water closet, food storage pantry, walk in wardrobe, corridor, hallway, lobby or clothes drying room.

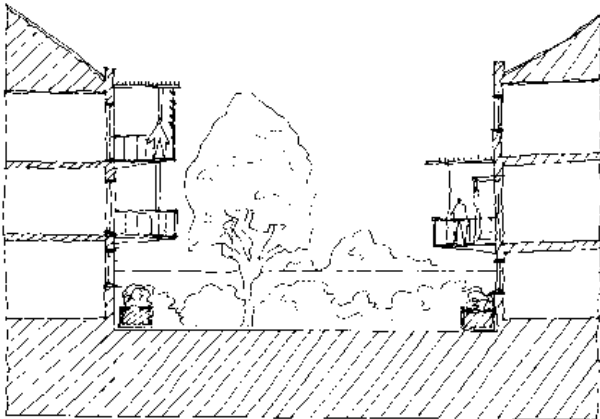
**FIGURE 24** Ensure adequate separation between unscreened balconies  
Privacy at ground floor level provided by suitable sill heights and planting



**FIGURE 25** Careful location of balconies can increase privacy and reduce their separation



**FIGURE 26** Vegetation and balcony screening can increase separation to ensure privacy.



## D6.6.5 Private open space

Private open space includes landscaped area (such as permeable garden areas), and above ground open space such as roof gardens over car parking, terraces, loggias, balconies or decks. The accessibility of comfortable private and communal outdoor living areas is a major determinant of the ability of occupants to enjoy living and working in the centre. Open space plays an important role in the identity of the Rose Bay Centre, and assists stormwater management.

### 6.6.5.1 Landscaped area

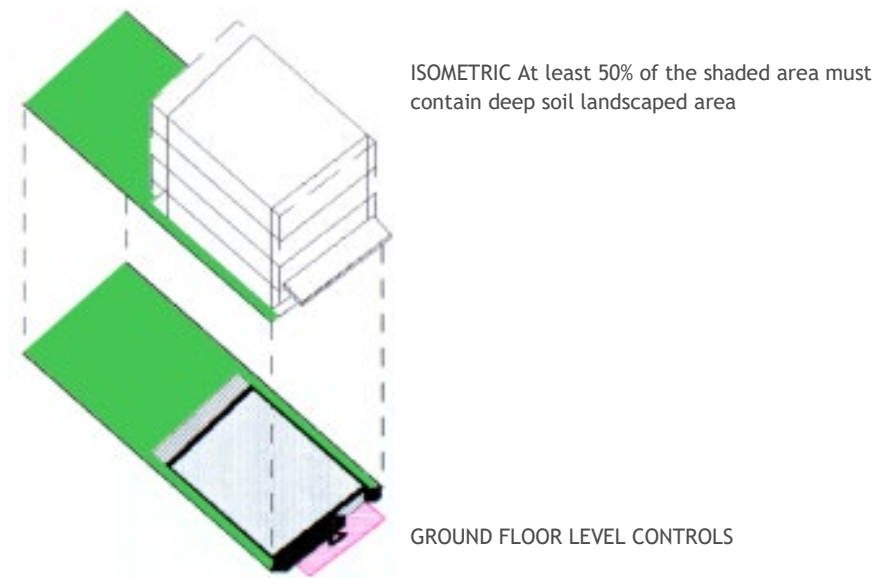
Landscaped area is an important contributing factor to the identity of the Rose Bay Centre.

Whilst the provision of deep soil landscaped area in the Core is limited due to the deep plan requirements of shops on the ground floor, the existing leafy character of the Transition Areas is formed in a large part by private gardens, which collectively create larger scale landscape spaces.

Deep soil landscaped areas play an important role in stormwater management. Contiguous garden areas assist site drainage and reducing runoff.

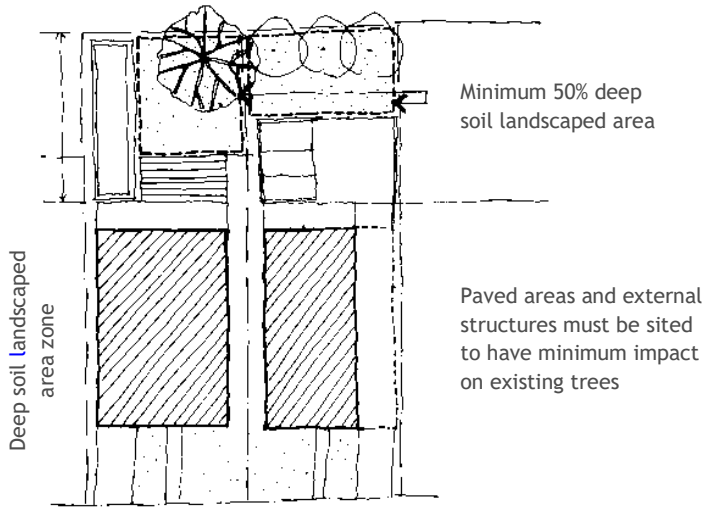
There is no deep soil landscaped area requirement for sites located in the Core.

**FIGURE 27** Three dimensional controls – Highlighting the area for deep soil landscaped area



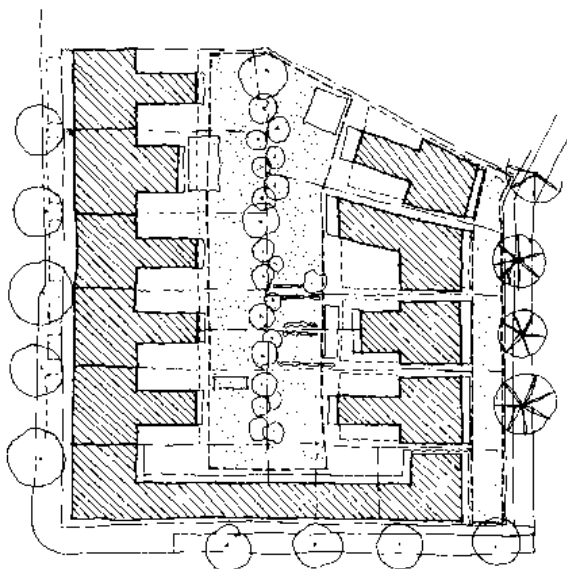
**FIGURE 28** Rear gardens

At least 50% of the area nominated in the control drawing should contain deep soil landscaped area



**FIGURE 29** Contiguous gardens

Create contiguous garden areas to form large scale landscape space





## Objectives

- O1 Maintain and enhance landscape quality on private land.
- O2 Encourage contiguous rear garden areas in the middle of blocks to enable retention of existing significant trees and to allow new planting of tall trees.
- O3 Encourage contiguous front garden areas to strengthen the street character and allow street surveillance.
- O4 Assist in stormwater control by maximising on-site infiltration through the use of permeable surfaces, and providing stormwater detention in the consolidated landscape areas.
- O5 Encourage the use of planting to assist in energy conservation in buildings and comfort of outdoor living areas, and to protect privacy through screening.

## Controls

### *General*

- C1 The area of deep soil landscaped area should be at least 50% of the area outside the building envelope.
- C2 Planting of larger trees is encouraged to maintain Rose Bay's existing leafy quality. Where views are an issue, plant high branching native trees, or deciduous trees. In smaller courtyard spaces deciduous tree planting is preferred.
- C3 Provide trees and pergolas to shade external areas and control sunlight into buildings.
- C4 Paved areas and external structures must be sited to have minimum impact on existing significant trees.
- C5 A landscape plan is submitted as part of any development application that includes a component of multi dwelling housing.

### *Front gardens*

- C6 Design front gardens to provide a positive setting for the building.
- C7 Design front gardens for security by providing adequate lighting to entrances. Avoid planting which may obscure the entry.
- C8 Garden structures such as gazebos, clothes lines, play equipment, swimming pools, spa baths and ponds, are not permitted in front gardens.
- C9 Garages and parking structures are not permitted forward of the building alignment.
- C10 Minimise the impact of driveways in front gardens by design, materials selection and appropriate screen planting.
- C11 Driveways, kerb crossings, parking, paved areas and external structures must be sited to have minimum impact on the root zone of existing street trees.

### 6.6.5.2 Above ground open space

The provision of deep soil landscaped areas, particularly in the Core is limited due to the deep plan requirements of shops on the ground floor, and underground parking. In these areas open space must be provided above ground, as roof gardens over car parking, roof terraces, loggias, balconies, and verandahs (refer to control drawings in Sections 6.5.2-6.5.8).

#### Objectives

- O1 Ensure every dwelling in the Rose Bay Centre has access to private open space by providing usable above ground open space on sites where there is no requirement for deep soil landscaped area. Refer to control drawings.
- O2 Encourage occupied roof areas with roof gardens behind parapets where private open space at ground level is not available.

#### Controls

- C1 Where direct access to ground level private open space is not available, provide at least one balcony, terrace, verandah, loggia, roof terrace or deck for each dwelling, within the area nominated for building articulation. The minimum area of this element is determined by the dwelling size (see table). The minimum permissible depth is 1.8m and the preferred depth is 2.4m. This element should be accessible from a principal living space.

Dwelling size	Minimum required area of above ground open space
<b>Small dwelling:</b> Up to 60m <sup>2</sup>	8m <sup>2</sup>
<b>Medium dwelling:</b> 60m <sup>2</sup> - 90m <sup>2</sup>	12m <sup>2</sup>
<b>Large dwelling:</b> More than 90m <sup>2</sup>	16m <sup>2</sup>

- C2 Roof terraces and balconies must be designed to protect the privacy of neighbours.
- C3 The profile and silhouette of parapets, eaves and roof top elements must be considered in roof terrace design to provide an attractive building finish when viewed from the public and private domain.
- C4 Lightweight pergolas, sun screens, privacy screens and planters are permitted on the roof, provided they do not increase the bulk of the building, and do not significantly affect the views enjoyed by adjoining properties, or those in the vicinity or on the nearby ridges.
- C5 Plantings over underground structures should have sufficient soil depth to allow sustainable planting.

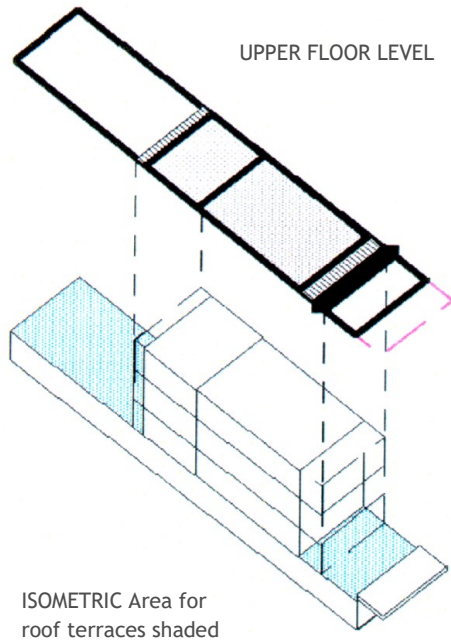
Note: A site specific landscape specification is to be prepared for landscaping above underground structures. The specification should include considerations such as plant species, soil depth and drainage.

**FIGURE 30** Above ground open space

Lightweight pergolas, sun screens and planters can enhance the quality of roof spaces, and provide privacy



**FIGURE 31** Three dimensional controls – Highlighting the area for roof terraces



---

### 6.6.5.3 Front fences

Front fences occur only in the Transition Areas in the Rose Bay Centre where buildings are set back from the street alignment. They are generally integrated with the architecture of the building, enhancing its character, and contributing to the visual appeal of the street.

#### Objectives

- O1 Encourage the design of front fences which enrich the streetscape in Transition Areas.
- O2 Ensure street surveillance is possible to assist safety.

#### Controls

- C1 The maximum height of front fences is 1.2m.
- C2 Fences should be integrated with the building and landscape design through the use of materials and detailing.
- C3 Fences should highlight building entrances, and allow for outlook and street surveillance.

## D6.6.6 Solar access and natural ventilation

---

### 6.6.6.1 Solar access

Solar access is a major determinant of environmental comfort. Good passive solar design offers financial benefits by reducing the need for artificial heating and cooling.

#### Objectives

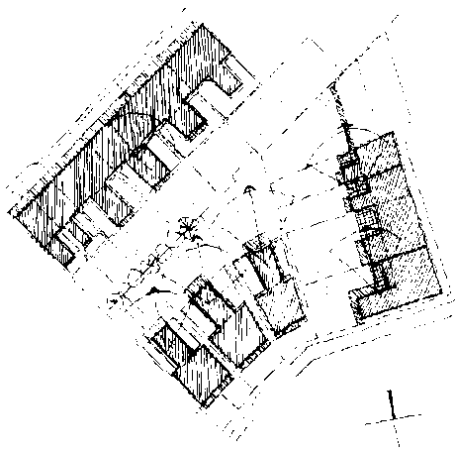
- O1 Minimise overshadowing of adjoining properties or publicly accessible spaces.
- O2 Building form, spacing, and layout should facilitate good solar access to both the internal and external living spaces, to maximise natural heating and cooling and minimise the use of artificial systems.

#### Controls

- C1 Development should comply with the control drawings in Section D6.5 to ensure adequate solar access is provided to neighbouring properties.
- C2 Development which does not comply with the control diagrams must maintain existing solar access to existing development for at least three hours between 9am and 3pm on 21 June

to north facing windows of habitable rooms, and at least two hours to at least 50% of the private open space.

- C3 Access to sunlight should be achieved for a minimum period of three hours between 9am and 3pm on 21 June to windows of habitable rooms and two hours to private open space of new development.
- C4 The overshadowing effect of new buildings on public domain areas are to be considered for the hours of 10am to 2pm on 21 March, 21 June and 24 September.
- C5 Locate main living spaces including lounge, dining, kitchen and family rooms towards the north where possible. Consideration should also be given to slope, views, existing vegetation, overshadowing and streetscape.
- C6 Skylights which provide the sole source of daylight and ventilation to habitable rooms are not permitted in residential or commercial areas.



**FIGURE 32** Solar access

Building form modulated within envelope to maximise good solar access to internal and external living spaces

### 6.6.6.2 Natural ventilation

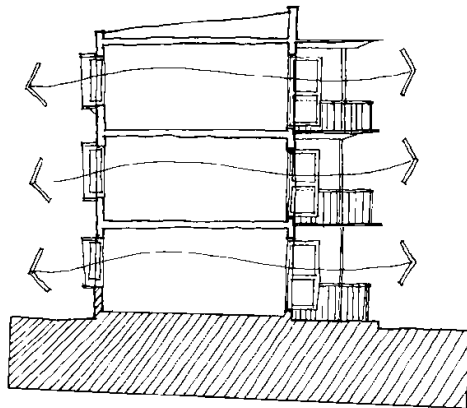
Building envelopes in this chapter encourage building depths on floors above street level that allow good natural ventilation and light. The location of the Rose Bay Centre in proximity to the harbour provides access to cooling summer breezes.

#### Objectives

- O1 All buildings should be designed for good natural ventilation.

#### Controls

- C1 Provide windows to all rooms above ground floor level, including kitchens and bathrooms, to facilitate natural light and ventilation. Minimise the reliance on mechanical ventilation or air conditioning above ground level.
- C2 Facilitate cross ventilation by locating windows opposite each other where possible. The placement of small low windows on the windward side of a building, and larger higher windows on the leeward side, will encourage cross ventilation.



**FIGURE 33** Cross ventilation

Thin cross-section design achieves good cross ventilation and avoids need for internal rooms

## D6.6.7 Parking and servicing

### 6.6.7.1 On-site parking

On-site parking includes surface parking areas, car parking structures, semi-basement and underground parking areas.

The opportunity for on-site parking is restricted in many areas of the Rose Bay Centre. The narrow width of some lots makes it impossible to accommodate more than two spaces onsite, and site excavation for underground parking is made difficult by the level of the existing water table in the centre.

This chapter aims to satisfy the parking demand likely to be generated by future development, whilst facilitating the redevelopment of narrow sites and discouraging over-reliance on cars.

#### Objectives

- 01 Facilitate the redevelopment or incremental development of narrow sites by implementing a parking contributions scheme to provide public car parking.
- 02 Ensure the impact of car parking on the site and streetscape is handled discretely.
- 03 Ensure the design of on-site car parking is safe and efficient, and integrated with the overall site and building design.
- 04 Maximise natural light and ventilation to parking areas where possible.

#### Controls

##### General

- C1 Car parking provision must comply with Part E of this DCP, the Chapter E1 Parking and Access.

- C2 Car parking should be incorporated within the building, behind the building alignment.
- C3 Consolidated parking areas should be provided below ground or screened from the street and concentrated under building footprints, to maximise the area for landscaped area.
- C4 Basement parking should be naturally lit and ventilated, where practical.

Note: Where the parking involves excavation, Council will normally require geotechnical and hydrological reports prepared in accordance with the Council’s ‘Guide for preparing Geotechnical and Hydrogeological Reports’ to demonstrate that there are no adverse geotechnical or hydrogeological impacts on any surrounding property and infrastructure as a consequence of the carrying out of development.

*Retail component*

- C5 Retail development is required to provide a minimum of 80% of the required parking as an off-site contribution with the balance of the spaces provided on-site as private parking. The provisions for the off-site contribution are detailed in the Woollahra Section 94 Contributions Plan.

*Commercial component*

- C6 Commercial development is required to provide a minimum of 80% of the required parking on-site as private parking with the balance of the required spaces provided as an off-site contribution.
- C7 The provisions for the off-site contribution are detailed in the Woollahra Section 94 Contributions Plan.

**6.6.7.2 Vehicular access**

Vehicular access frontage, as indicated on the control drawings, is the preferred location for vehicular access to private sites (see Sections 6.5.2-6.5.8).

The continuity of retail frontages contributes to the liveliness of the Rose Bay Centre and its village character. Vehicular crossings interrupt street activity, diminish the amenity of the place, and reduce the area for public on-street parking.

**Objectives**

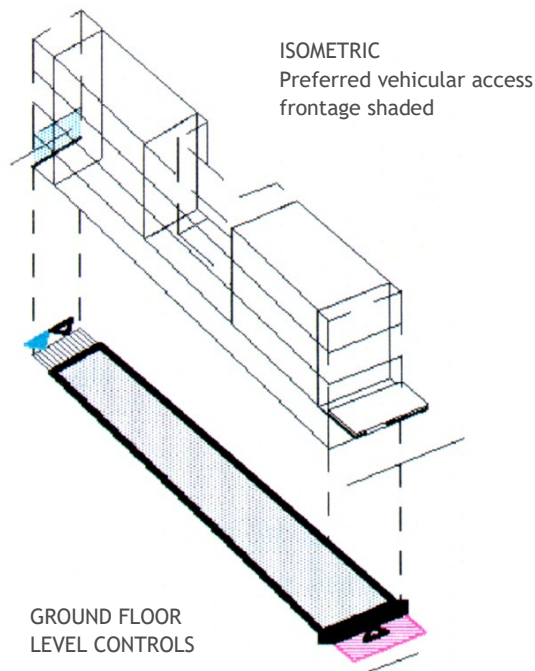
- O1 Encourage discrete access to car parking and servicing.
- O2 Maximise retail frontage in nominated streets.
- O3 Maximise pedestrian safety and amenity by minimising conflict with vehicles.

**Controls**

- C1 In the Core vehicular access is only permitted via a rear lane, rear right of way, or side street.

- C2 In the Transition Areas vehicular access must be via a rear lane, rear right of way, or side street where such access is available.
- C3 Driveway widths should be minimised.
- C4 Allow up to one two-way driveway per development. Two single driveways may only be provided where the distance between crossings exceeds 30m.
- C5 Driveways to underground car parks should be designed with minimal visual impact on the street, and maximum pedestrian safety. Pedestrian access to the development should be separate and clearly defined. Garage doors should be set back. Access ways to underground car parking should not be located in direct proximity to doors or windows to habitable rooms.
- C6 Driveways and kerb crossings must be sited to have minimum impact on the root zone of existing street trees (refer to the Public Domain Improvements Plan and Streetscape Design Manual advice from Council's Technical Services Division).
- C7 Driveways must be located in alignment with the garage. They must occupy a minimum proportion of any front garden area.

**FIGURE 34** Three dimensional controls – Highlighting the preferred vehicular access frontage





**FIGURE 35** Vehicular access

Driveways and garages designed with minimal impact on the street.  
Garages set back with pedestrian access separate and clearly defined.



### D6.6.8 Geotechnology and hydrogeology

Council will normally require geotechnical and hydrogeological reports for development applications which include below ground structures.

Any proposed development with below ground structures must consider the sub-surface conditions and the effects of construction on adjacent properties. In addition, those which are likely to extend below the level of seasonal fluctuations in the groundwater table, must also consider the effect of any changes induced in the sub-surface water levels and the groundwater flow patterns on adjacent properties. Unless site specific information exists to the contrary, excavations deeper than 1m must be assumed to have this potential to intersect the groundwater level.

Council’s principal objective is to ensure there are no adverse geotechnical and hydrogeological impacts on any surrounding property and infrastructure as a result of development, during and after construction. Typically, adverse geotechnical impacts may include vibration induced settlements from construction methods and equipment and inadequate support of adjacent land during and after construction. Typically adverse hydrogeological impacts may include settlement induced by changes in the groundwater level and seepage problems.

#### Objectives

Buildings must be designed and constructed with appropriate support and retention systems to ensure that:

- O1 There will be no ground settlement or movement, during and after construction, sufficient to cause an adverse impact on adjoining properties and infrastructure.

- 
- O2 There will be no change to the ground water level, during and after construction, sufficient to cause an adverse impact on surrounding properties and infrastructure.
  - O3 Vibration during construction is minimised or eliminated to ensure no adverse impact on surrounding properties and infrastructure.
  - O4 The risk of damage to adjacent existing property and infrastructure by the new development will be reduced to a level no greater than that from an event with an “unlikely” likelihood of occurrence and “minor” consequence.

In this control “adverse impact” means any damage caused to the improvements on adjoining properties by the demolition, excavation or construction on the development site.

### Controls

- C1 Excavation below 1m is accompanied by a geotechnical report and a structural report to demonstrate that the works will not have any adverse effect on the neighbouring structures.

Note: Council may identify other circumstances where these reports are required. All reports must be prepared in accordance with Council’s guidelines. Council may also require the preparation and submission of a pre-commencement dilapidation report for properties neighbouring the development. Development applications include a design statement and supporting drawings (if necessary) that show the proposed design measures minimise risk and ensure that no adverse impacts will occur.

## D6.6.9 Site facilities

---

Site facilities include loading areas, garbage areas, fire safety systems, mail boxes, external stores, laundries and clothes drying areas. Development should provide appropriate site facilities for retail, commercial and residential uses, and minimise impact on the streetscape.

### Objectives

- O1 Ensure adequate provision of site facilities.
- O2 Ensure site facilities are accessible, functional and unobtrusive.

### Controls

- C1 Loading facilities must be provided via a rear lane or side street where such access is available.

Any development which includes a residential component must provide laundry facilities, and at least one external clothes drying area. The public visibility of this area should be minimised.

C2 Hydraulic fire services such as fire hydrants and booster installations are concealed. These services are to be:

- a) enclosed with doors if located in the building façade, or
- b) housed in a cabinet or enclosure if located external to the building.

The location, design, colour and material of the doors, cabinet or enclosure are visually unobtrusive and suitably integrated with the development, including any fencing and landscaping.

C3 Lockable mail boxes should be provided close to the street, and integrated with front fences or building entries.

C4 Buildings are designed to accommodate venting from ground floor uses, to avoid potential impacts from exhaust and odour, such as cooking smells.

C5 Air conditioning units should not be visible from the public domain.

C6 An electricity substation is to be suitably located, screened and/or concealed so it is not visible from the street, or any other adjoining public place. Council's preference is for a chamber substation. Any screening or enclosure to conceal the substation is to be visually unobtrusive and suitably integrated with the development, including the fencing and landscape design.

C7 The design and location of all other aboveground utility infrastructure (such as electrical pillars etc.) should minimise visual clutter within the streetscape and provide for a continuous accessible path of travel, where practical to ensure safe and equitable pedestrian circulation for people of all abilities. (Where this provision and Ausgrid's requirements cannot both be satisfied, the applicant is to develop in consultation with Council and Ausgrid a solution that meets the acceptance of both consent authorities.)

Notes:

- At the DA stage the applicant should demonstrate that they have engaged with Ausgrid and have a network capacity assessment undertaken for the proposed development.
- Where a substation is required, the substation should be identified on the DA plans and addressed in the *SEPP 65 Design Verification Statement* (also see Apartment Design Guide Objective 3C-2 Amenity of the public domain is retained and enhanced).
- The DCP requirements for substations apply in addition to the Ausgrid Network Standards, such as *NS113 Site selection and construction design requirements for chamber substations*. Separate Ausgrid approval for the substation will be required.
- A dedicated access way/easement through the site to the substation will also need to be provided in accordance with the requirements of Ausgrid and Council.

## D6.6.10 Application of bonuses

---

The Rose Bay Urban Design Study explored the urban potential of the centre, and sought feedback from the community reference group to identify a variety of public domain improvements including:

- ▶ a public square on New South Head Road linking the centre to the harbour foreshore;
- ▶ through block connections, such as arcades, shareways, and through shop links;
- ▶ a shop front community service facility; and
- ▶ public conveniences.

Council supports the construction of the facility and conveniences as part of private developments in the centre. Bonus FSR and height is available in Woollahra LEP 2014 for the provision of a public square.

It should be noted that provision of such facilities does not automatically mean that bonuses will be awarded. Each application will be dealt with on its merits.

### Objectives

- O1 The aim of a bonus system is to encourage the provision of public benefits as part of the redevelopment of privately owned sites. In return Council will offer certain bonuses or concessions with regard to development standards and controls.

### Controls

- C1 In determining the extent of bonuses granted, Council will examine the development against three general criteria:
- a) the need for the bonus facility, based on the recommendations of the Rose Bay Urban Design Study;
  - b) the design and usefulness of the bonus facility provided on site or within the building to the general community; and
  - c) the effect the inclusion of a bonus facility or facilities has on the building's bulk and form and the building's relationship with the character of adjoining development. This chapter identifies specific public facilities which Council wishes to encourage.

#### 6.6.10.1 Rose Bay Centre Square

The Rose Bay Urban Design Study identified the need for a Rose Bay Village Centre. It proposed a 'square' on New South Head Road, linking the centre and the harbour foreshore, to create a focus for the centre and to take advantage of its unique setting. Figures 36 and 37 indicate the location of the proposed square and provide concept designs as a guide. Council will consider other designs on their merit.

To facilitate the square, Woollahra LEP 2014 permits a maximum building height of 17.2m (5 storeys) and FSR of 2.25:1, subject to the development being compatible with the desired future character of the centre. The desired future character is articulated by the controls below.

These maximum height and FSR controls proposed will only be granted to the properties identified in clause 4.4C of Woollahra LEP 2014, and only if the properties are the subject of a single development application.

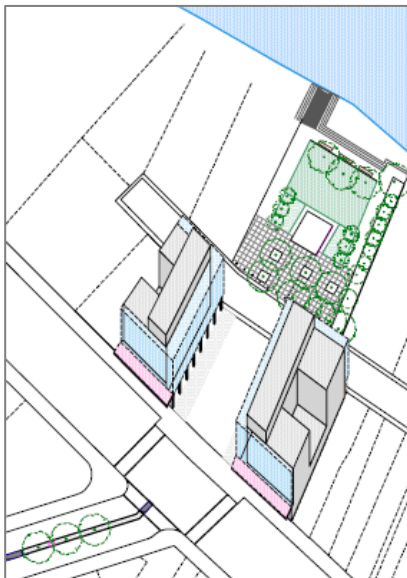
**FIGURE 36** Area designated for the Rose Bay Centre Square



**FIGURE 37** Rose Bay Centre Square design concept

Generous square creating a strong link at the end of Newcastle Street between the centre and the harbour foreshore

Colonnades provide protected edges to the square



---

## Objectives

- O1 Improve the visual and physical connection between the centre and the harbour foreshore.
- O2 Provide a memorable focus for the Rose Bay Centre.

## Controls

To be considered for bonus provisions the square must comply with the following controls:

- C1 The square must be located in the area designated for the construction of the 'Rose Bay Centre Square' (see Figure 36 Area designated for the Rose Bay Centre Square) which corresponds to clause 4.4C in Woollahra LEP 2014.
- C2 The square must be a consolidated outdoor space open to the sky with a minimum area of 350m<sup>2</sup>, excluding areas under colonnades.
- C3 The minimum aggregate width of the square along both the New South Head Road and Collins Avenue frontages is 9m. For example, a square with two open access points with a width of 4.5m each may be considered.
- C4 In mid-winter allow solar access to a minimum 30% of the area of the square at 12 noon and 70% of the area of the square at 3pm.
- C5 The maximum building coverage, including colonnades and building articulation, is 70% of the consolidated site area.
- C6 Provide a minimum 1.2m wide area for building articulation above street level to New South Head Road and the southern side of the square.
- C7 Provide a minimum 2.4m wide area for building articulation above street level to Collins Avenue and the northern side of the square.
- C8 A maximum internal plan depth of 12m above ground level applies (see Section 6.6.3.1 Building envelopes).
- C9 The inclusion of colonnades is encouraged to provide pedestrian amenity, encourage visual openness to the harbour, and as a distinctive and memorable characteristic of the square.
- C10 Any proposed colonnade must have a minimum soffit height of 3.2m. Colonnade design must be visually integrated with the development.
- C11 The levels and paving material within the colonnade should be contiguous with the surface of the square.
- C12 A wind study and shadow diagram must be submitted with the development application.

Note: Council will consider relaxation of one or a number of development standards and controls in its assessment of applications which include a public square as described above. However, it should be noted that such bonuses are not automatic and each application will be assessed on its merits.

A fifth storey is permissible as in Figure 37 above, subject to the following controls:

- C13 The area of the fifth storey must not exceed 40% of the consolidated site area.
- C14 The fifth storey must be set back the depth of the area for building articulation to minimise visibility from the public domain. For example, the minimum set back of the bonus storey from the new square is 2.4m.
- C15 The fifth storey should be designed to protect the privacy of adjacent dwellings, in particular those in Collins Avenue.

### Development incentives

If the Rose Bay Centre Square is proposed the following incentives will be considered:

- I1 Allow up to 40% of the area of the square to be set aside for private lease for open air cafes and the like, to the benefit of the owners, if the area of the square is less than 600m<sup>2</sup>.
- I2 Allow up to 60% of the area of the square to be set aside for private lease for open air cafes and the like, to the benefit of the owners, if the area of the square is greater than 600m<sup>2</sup>.
- I3 Reduced on-site parking requirements.
- I4 Discounted Section 94 Contributions.

#### 6.6.10.2 Through block connections

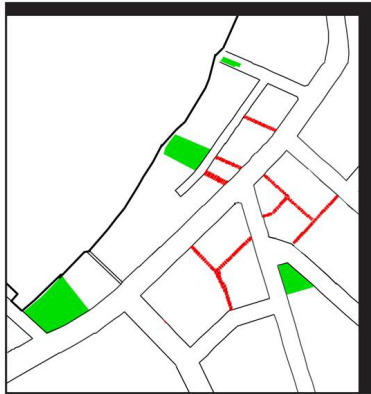
The Rose Bay Urban Design Study identified the need for better pedestrian and vehicular circulation within the centre. Council wishes to encourage the inclusion of ‘through block connections’, in specific areas, in private developments. These may include arcades, through shop links, shareways, laneways and rights of way.

Improved pedestrian access to and within public car parking areas is desirable to facilitate convenient use of the centre. There is potential to take better advantage of the centre’s unique location close to the harbour by providing better pedestrian access to Collins Avenue and Percival Park.

Servicing of shops and other commercial uses from the main street frontage, particularly along New South Head Road, Dover Road and Newcastle Street, disrupts the pedestrian amenity and on street parking spaces. In addition it creates conflict with the high volumes of traffic carried by these streets, particularly New South Head Road. In line with the stated design principle in Section 6.6.7.2 Vehicular access, Council is keen to encourage the creation of rear lane access to commercial properties in the centre.

Council may consider the relaxation of one or a number of standards and controls depending on the quality of public area provided and the merits of the particular application.

Council will not relax any standards or controls unless it can be demonstrated that a proposal satisfies the underlying objectives of the DCP and that compliance with relevant development standards would be unnecessary or unreasonable in the circumstances of the case.

**FIGURE 38** Areas designated for through block connections

### Objectives

- O1 Improve the pedestrian circulation in the centre by providing arcades, through shop links, and shareways in key locations, as identified in Figure 38 Areas designated for through block connections and Figure 39 Detailed location plan.
- O2 Maximise views to the harbour from the public domain.
- O3 Facilitate rear site access for car parking and servicing to avoid vehicular crossings on principal streets by providing new laneways and rights of way as identified in Figure 38 Areas designated for through block connections and Figure 39 Detailed location plan.

### Controls

- C1 Through block connections are encouraged by Council on the following basis:
  - a) Through block connections must be located in the areas shown in Figure 38 Areas designated for through block connections and Figure 39 Detailed location plan).
  - b) Through block connections must to the extent possible provide a clear sightline from one end to the other, for surveillance and accessibility, in any of the locations identified in Figure 38 Areas designated for through block connections and Figure 39 Detailed location plan.
  - c) Public use of through block connections should be available at least between the hours of 6am and 10pm daily.
- C2 Pedestrian safety and the security of adjacent businesses should be considered in the design of through block connections. Specific consideration must be given to street level lighting at night.
- C3 Through block connections must have a minimum width of 3m and be, clear of any obstruction, except for connections through shops.
- C4 Paving must be coordinated with public footpaths (refer to the Rose Bay Centre Public Domain Improvements Plan and seek advice from Technical Services).



The following controls apply to arcades:

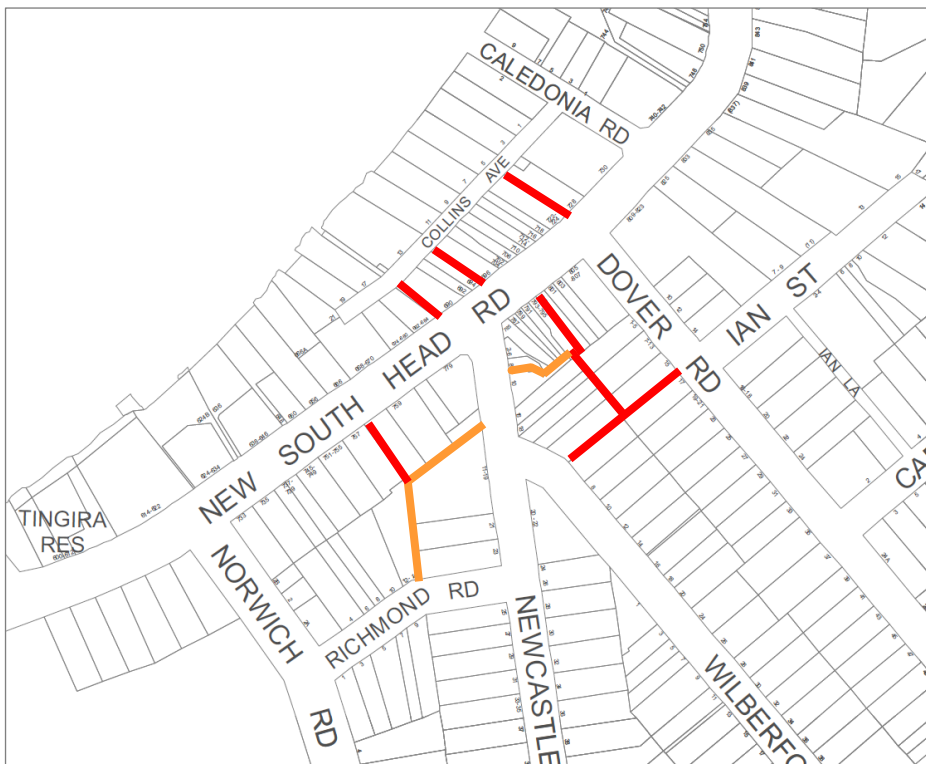
- C5 Retail frontages are to be maximised along arcades.
- C6 Arcades must have substantial natural lighting and ventilation.

The following controls apply to new lanes:

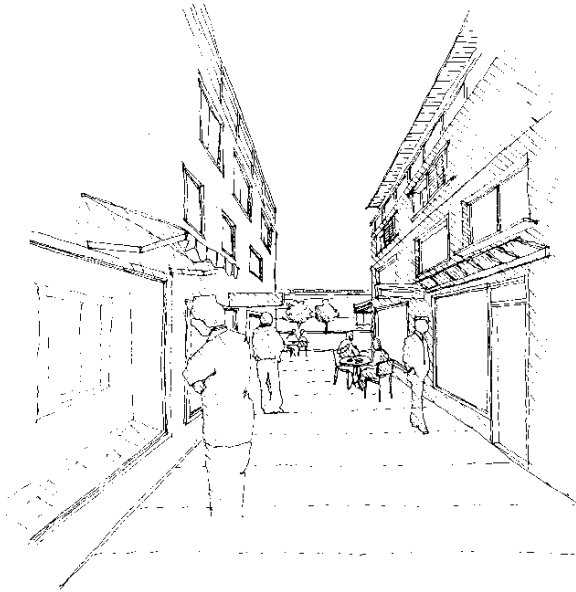
- C7 Lanes must have a minimum width of 3m if one way, and 5m if two way.
- C8 Carriageways and drainage should be coordinated between developments that collectively create new lanes.
- C9 Lanes must provide rear service access to properties fronting New South Head Road, Dover Road or Newcastle Street to sites which currently have only one vehicular frontage.
- C10 Buildings should address new lanes to provide passive surveillance.
- C11 Applicants must demonstrate that the proposed service lane will be of benefit to the traffic circulation system in the Rose Bay Centre as a whole.

**FIGURE 39** Detailed location plan

**Red** – Pedestrian link  
**Orange** – Vehicular/pedestrian link



**FIGURE 40** Arcades can improve circulation and provide additional retail frontage.

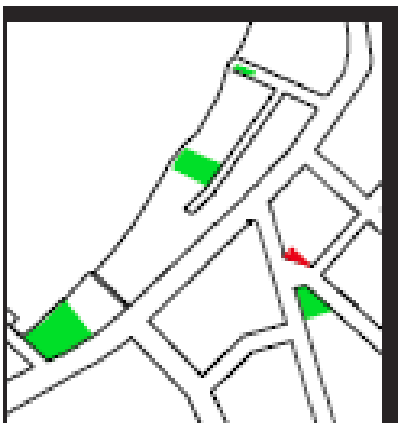


#### **6.6.10.3 Community facility and public conveniences**

The Rose Bay Urban Design Study identified the need for a community services facility and public conveniences in the Rose Bay Centre. Council may consider varying of one or a number of standards and controls depending on the suitability and merits of the facilities proposed.

Council will not relax any standards or controls unless it can be demonstrated that a proposal satisfies the underlying objectives of the DCP and that compliance with relevant development standards would be unnecessary or unreasonable in the circumstances of the case.

**FIGURE 41** Area designated for the construction of a community facility (highlighted in red)



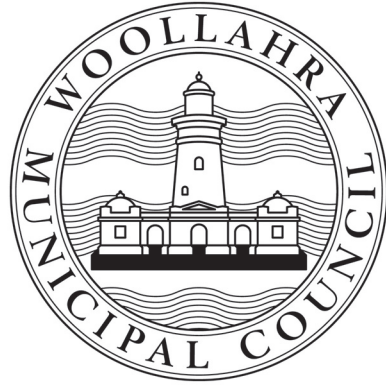
### Objectives

- O1 Provide a conveniently located meeting place for the community, where Council and other public organisations can advertise available community services.
- O2 Provide accessible, safe and durable public conveniences which cater for the broad needs of the community.

### Controls

Community facilities and public conveniences are encouraged by Council on the following basis:

- C1 The community facility should be located as identified in Figure 41 Area designated for the construction of a community facility.
- C2 The community facility must provide a community display area, public seating and public conveniences.
- C3 The minimum area of the community facility is 100m<sup>2</sup>, including conveniences.
- C4 The community facility may incorporate a privately operated cafe.
- C5 The community facility should clearly address the public domain.
- C6 Public conveniences should be incorporated in building developments generally, and should cater for the needs of people with mobility disabilities such as the elderly, and the needs of parents with infants.
- C7 The provision of natural light and ventilation to public conveniences is highly desirable.



## Part E ► General Controls for All Development

WOOLLAHRA DEVELOPMENT CONTROL PLAN 2015



# Chapter E1 Parking and Access

Part E ► General Controls for All Development

CHAPTER E1 APPROVED ON 12 DECEMBER 2016  
AND COMMENCED ON 21 DECEMBER 2016

Last amended on 31 May 2024



# Chapter E1 ► Parking and Access

## Contents

<b>E1.1</b>	<b>INTRODUCTION</b> .....	<b>1</b>
	E1.1.1 Land where this chapter applies .....	1
	E1.1.2 Development to which this chapter applies .....	1
	E1.1.3 Objectives .....	1
	E1.1.4 Relationship to other parts of the DCP .....	2
	E1.1.5 Relationship to other documents .....	2
<b>E1.2</b>	<b>PREPARING YOUR DEVELOPMENT APPLICATION</b> .....	<b>3</b>
	E1.2.1 Development applications and required information .....	3
	E1.2.2 Matters the consent authority will consider .....	4
	E1.2.3 Compliance with the parking controls .....	5
	E1.2.4 Monetary contributions instead of required parking spaces .....	5
<b>E1.3</b>	<b>HOW TO DETERMINE THE CAR PARKING RATE</b> .....	<b>6</b>
<b>E1.4</b>	<b>RESIDENTIAL PARKING</b> .....	<b>7</b>
	E1.4.1 Calculating required parking for residential uses .....	7
	E1.4.2 Residential parking generation rates .....	7
<b>E1.5</b>	<b>NON-RESIDENTIAL PARKING</b> .....	<b>10</b>
	E1.5.1 Calculating required parking for non-residential uses .....	10
	E1.5.2 Non-residential parking generation rates .....	10
	E1.5.3 Parking multipliers .....	13
<b>E1.6</b>	<b>BICYCLE PARKING AND END-OF-TRIP FACILITIES</b> .....	<b>15</b>
	E1.6.1 Calculating required bicycle parking .....	15
	E1.6.2 Bicycle parking rates .....	16
<b>E1.7</b>	<b>MOTORCYCLE PARKING RATES</b> .....	<b>18</b>
	E1.7.1 Calculating required motorcycle parking .....	18
<b>E1.8</b>	<b>VARIATIONS TO THE PARKING GENERATION RATES</b> .....	<b>19</b>
	E1.8.1 Application of variations .....	19
	E1.8.2 Items of the environmental heritage .....	19
	E1.8.3 Mixed use developments .....	19
	E1.8.4 Certain land in Paddington zoned MU1 Mixed Use .....	19
	E1.8.5 Business zoned land in Double Bay .....	20
	E1.8.6 Health care professional uses in Edgecliff Road, Adelaide Street and Vernon Street, Woollahra .....	20
<b>E1.9</b>	<b>SPECIAL PROVISIONS</b> .....	<b>21</b>
	E1.9.1 Car parks with 20 or more spaces .....	21
	E1.9.2 Car share .....	21
	E1.9.3 Tandem parking .....	22
	E1.9.4 Health consulting rooms .....	22
	E1.9.5 Parking spaces for people with a disability .....	22
	E1.9.6 Small car parking spaces .....	22



---

E1.9.7 Resident Parking Scheme (RPS) Areas .....	23
<b>E1.10 PARKING AND ACCESS DESIGN STANDARDS .....</b>	<b>23</b>
E1.10.1 Design and use of parking areas.....	23
E1.10.2 Australian Standards .....	23
E1.10.3 Car parking space and bay size.....	23
E1.10.4 Ramps and primary aisles .....	24
E1.10.5 Turning paths.....	24
E1.10.6 Driveways and access points.....	25
E1.10.7 Signposting.....	26
E1.10.8 Landscape plan.....	26
E1.10.9 Drainage of car parking areas .....	26
<b>E1.11 ELECTRIC VEHICLE CHARGING POINTS .....</b>	<b>27</b>
<b>E1.12 GREEN TRAVEL PLANS .....</b>	<b>29</b>
E1.12.1 Green travel plan thresholds .....	30
<b>E1.13 OPERATIONAL TRAFFIC MANAGEMENT PLAN .....</b>	<b>31</b>
E1.13.1 Operational traffic management plan for non-residential developments .....	31
E1.13.2 Details an operational traffic management plan.....	31
<b>E1.14 OFF-STREET LOADING AND SERVICING FACILITIES .....</b>	<b>32</b>
E1.14.1 Number of loading bays required .....	32
E1.14.2 Location and design of loading bays.....	32
<b>E1.15 MECHANICAL PARKING INSTALLATIONS AND PAID PARKING STATIONS .....</b>	<b>33</b>
E1.15.1 Locations and land use.....	33
E1.15.2 Compliance with the Australian Standards.....	33
E1.15.3 Waiting bays .....	33
E1.15.4 Car parks with more than 25 vehicles.....	34
E1.15.5 Residential visitor parking .....	34
E1.15.6 Access.....	34
E1.15.7 Development application information .....	34

---

## E1.1 Introduction

Parking areas, garages and driveways must be carefully designed so that they do not detract from the appearance of the development and the surrounding streetscape. They should also be designed to limit the amount of impervious surfaces over a site and excavation required.

The chapter establishes the car parking and vehicle access requirements for development.

The parking generation rates for residential development are maximum rates, whereas the parking generation rates for non-residential development are minimum rates.

### E1.1.1 Land where this chapter applies

---

This chapter applies to all land within the Woollahra Municipality.

### E1.1.2 Development to which this chapter applies

---

This chapter applies to development that requires consent and may generate demand for parking, loading or other associated facilities.

This chapter adopts the land use definitions and terms of the Woollahra Local Environmental Plan 2014 (Woollahra LEP 2014). In doing so, it sometimes uses group terms and sub-terms. Where a land use fits into a group term but is also separately defined as a sub-term, the parking generation rate for the sub-term should be applied.

For example, the group term “food and drink premises” includes the sub-terms “restaurants”, “take away food premises” and “pubs”. This chapter contains a parking generation rate for both “food and drink premises” and “pubs”. If the development application is for a pub, the rate for a “pub” should be applied instead of the rate for the group term “food and drink premises”.

### E1.1.3 Objectives

---

The objectives of this chapter are:

- 01 To minimise the amount and impact of vehicular traffic generated due to proposed development.
- 02 To ensure that development generating vehicular traffic makes adequate provision off street for the car parking and servicing needs of its occupants and users, including residents, employees, visitors and deliveries.
- 03 To ensure the safe and efficient movement of vehicles within, entering and leaving properties.

- 
- 04 To minimise the environmental effects, particularly visual impact, of parked vehicles on the amenity of the municipality.
- 05 To ensure that access points to car parking areas are situated to minimise disruption of vehicle movement on the public road system.

### E1.1.4 Relationship to other parts of the DCP

---

This chapter is to be read in conjunction with the other parts of the DCP that are relevant to the development proposal, including:

- ▶ Part B: General Residential.
- ▶ Part C: Heritage Conservation Areas.
- ▶ Part D: Business Centres.
- ▶ Part E: General Controls for All Development - this part contains chapters on Parking and Access, Stormwater and Flood Risk Management, Tree Management, Contaminated Land, Waste Management, Sustainability, Signage and Adaptable Housing.
- ▶ Part F: Land Use Specific Controls - this part contains chapters on Child Care Centres, Educational Establishments, Licensed Premises and Telecommunications.

Note, depending on the location of the proposed development, Part B: General Residential, Part C: Heritage Conservation Areas or Part D: Business Centres, must be considered with the parking generation rates in this chapter.

Parts B, C and D contain streetscape and other design controls relating to parking and driveways.

In some residential locations the maximum number of on-site parking spaces may not be able to be achieved because the parking would detrimentally impact on the character of the streetscape. The precinct controls in Parts B and C prevail over the residential parking generation rates in this chapter.

### E1.1.5 Relationship to other documents

---

In implementing this DCP the following Australian Standards apply for the design of parking and loading facilities, unless otherwise specified:

- ▶ AS/NZS 2890.1 Part 1: Off-street car parking;
- ▶ AS 2890.2 Part 2: Off-street commercial vehicle facilities;
- ▶ AS 2890.3 Part 3: Bicycle parking;
- ▶ AS 2890.5 Part 5: On-street parking; and
- ▶ AS/NZS 2890.6 Part 6: Off-Street parking for people with disabilities.

## E1.2 Preparing your development application

### E1.2.1 Development applications and required information

Development applications are to be accompanied by dimensioned plans, drawn to scale, showing proposed locations and arrangements for:

- ▶ off-street parking;
- ▶ loading and unloading areas (where applicable);
- ▶ circulation of traffic within, into and out of the property;
- ▶ position and gradients of access aisles, entrances and exits;
- ▶ location of electric vehicle charging points and circuitry (where required); and
- ▶ landscaping.

#### Additional information

A traffic and parking report, prepared by a suitably qualified person, may be required by Council for certain developments, including:

- ▶ all traffic generating developments listed in Schedule 3 of the *State Environmental Planning Policy (Infrastructure) 2007*;
- ▶ supermarkets;
- ▶ shopping centres;
- ▶ child care centres;
- ▶ mixed use developments;
- ▶ residential flat buildings, manor houses, multi dwelling housing and multi dwelling housing (terraces);
- ▶ health services facilities (e.g. medical consulting rooms, medical centres and hospitals);
- ▶ community facilities;
- ▶ entertainment facilities (e.g. cinemas and theatres);
- ▶ recreation facility (indoor, major and outdoor facilities);
- ▶ function centres;
- ▶ tourist facilities;
- ▶ tourist and visitor accommodation (e.g. hotel or motel accommodation, serviced apartments);
- ▶ educational establishments;
- ▶ public car parks;
- ▶ places of public worship;
- ▶ premises licensed under the *Liquor Act 2007* of the *Registered Club Act 1976*;
- ▶ drive-in take-away food outlets; and
- ▶ service stations.

Applicants should also refer to requirements for information and referrals under the provisions of *State Environmental Planning Policy (Infrastructure) 2007* (Infrastructure SEPP). Refer to Council's Development Application Guide (DA Guide) for further information.

---

## E1.2.2 Matters the consent authority will consider

---

Where premises are proposed to be used for more than one purpose, the parking provisions should satisfy the requirements of this chapter in relation to each use. Council may approve, or require, the reservation of a proportion of the total number of required spaces on-site for the use of specific occupants or visitors to a development.

In determining car parking provision for any development, including a change of use, Council will take into account the following matters:

- ▶ the scale and nature of the development;
- ▶ existing traffic generation associated with the site;
- ▶ traffic generation associated with the proposed development;
- ▶ traffic volumes on the road network in the area of the development and the capacity of the road network;
- ▶ impacts on traffic and pedestrian safety;
- ▶ impacts on residential amenity;
- ▶ for commercial development—the type of activities on the site, including allocation floor area for different uses associated with the commercial development e.g., area dedicated to back-of-house uses such as storage areas;
- ▶ for residential development—a proposal to accommodate a car share scheme parking space on the site or directly adjoining the site;
- ▶ methodologies to ameliorate traffic generation impacts (e.g. traffic calming);
- ▶ the availability of public parking (on-street and off-street) near the development;
- ▶ the availability of public transport to serve the development;
- ▶ the probable mode of transport of users to and from the development;
- ▶ the suitability of street lighting in the area;
- ▶ whether the development warrants special consideration because it is proposed for, or relates to, a heritage item;
- ▶ the characteristics of the streetscape and the site, particularly the subdivision pattern, topography, street design and width, street tree planting, on-street parking or loading spaces and any existing access arrangements; and
- ▶ construction method.

---

### E1.2.3 Compliance with the parking controls

---

This chapter contains minimum parking generation rates for non-residential development and maximum rates for residential development.

However, to achieve environmentally acceptable solutions, every individual case needs to be considered on merit having regard to the circumstances of the proposal.

#### Non-compliance with the parking controls

Council may allow non-compliance with the requirements of this chapter in exceptional circumstances. The applicant will be required to demonstrate, to the satisfaction of Council, the exceptional circumstances relating to a particular development application which would warrant non-compliance with the requirements of this chapter.

In its consideration of any non-compliance, Council will have regard to the objectives of this chapter, as well as other relevant chapters, and the specific nature of the exceptional circumstances as they relate to the parking requirement.

Council must be satisfied that the development seeks to minimise and manage the impact of traffic generation, and does not unreasonably increase demand for on-street parking, having regard to the existing context and capacity. A traffic and parking report, prepared by a suitably qualified person, may need to be submitted with the development application to demonstrate this. The requirements of the report are specified in the DA Guide.

---

### E1.2.4 Monetary contributions instead of required parking spaces

---

A monetary contribution may be required, or may be accepted, for a shortfall in car parking spaces for development in certain commercial centres. The Woollahra Section 94 Contributions Plan identifies the commercial centres where contributions apply and sets down the contribution rates.

When determining whether a monetary contribution is required, Council will consider the following matters:

- ▶ whether in terms of relevant design and operational standards it is physically possible to provide the total required number of car parking spaces, manoeuvring areas and access areas on-site;
- ▶ whether long-stay car parking demand will be provided for on-site;
- ▶ whether opportunities exist, or could be made available, for shared parking arrangements;
- ▶ whether it is appropriate to establish additional ingress and egress points;
- ▶ whether car parking on a particular site would be restricted or excluded altogether for reasons of pedestrian safety and comfort, or in order to minimise and avoid vehicle conflicts;
- ▶ whether an otherwise environmentally acceptable development may be refused consent on the grounds of inability to satisfy the parking space requirements; and
- ▶ the findings and recommendations of any traffic and parking study.

## E1.3 How to determine the car parking rate

The number of car parking spaces to be provided on a site is determined by addressing the following parts of this DCP:

	Residential development	Non-residential development
<b>Step 1</b>	<p>Go to <b>Section E1.4 Residential parking</b>: Identify the parking rate for your development type.</p>	<p>Go to <b>Section 1.5.2 Non-residential parking generation rates</b>: Identify the base generation parking rate applying to the land use that reflects your development.</p>
<b>Step 2</b>	<p>Go to the residential precinct controls in <b>Part B of this DCP</b>: Read the desired future character, streetscape and location of the garages controls that apply to your residential precinct. The provision of on-site car parking and garaging should not compromise the streetscape amenity.</p>	<p>Go to <b>Section 1.5.3 Parking multipliers</b> Identify if a multiplier applies to the centre where your development is proposed. If yes, multiply the base parking generation rate by the multiplier. Round up to the nearest whole number for the required parking rate.</p>
<b>Step 3</b>	<p>Go to <b>Section E1.6 Bicycle parking rates and Section E1.7 Motorcycle parking rates</b>: Identify the bicycle and motorcycle parking rates for your development type.</p>	<p>Go to <b>Section E1.6 Bicycle parking rates and Section E1.7 Motorcycle parking rates</b>: Identify the bicycle and motorcycle parking rates for your development type.</p>
<b>Step 4</b>	<p>Go to <b>Section E1.8 Variations to the parking generation rates</b>: Determine if a variation to the parking rate applies. For example, the property may be a heritage item.</p>	<p>Go to <b>Section E1.8 Variations to the parking generation rates</b>: Determine if a variation to the parking rate applies. For example, the proposal may be a change of use and located in Oxford Street, Paddington.</p>

Note: The steps above help determine the number of on-site parking spaces to be provided. You must consider these parking generation requirements in conjunction with the other controls and design requirements in this chapter.

## E1.4 Residential parking

This section contains parking generation rates and design controls for parking in residential developments, including the residential component of mixed use development.

### E1.4.1 Calculating required parking for residential uses

#### Residential parking generation rates

Table 1 set outs the parking generation rates for residential land uses. The rates identify the maximum number of parking spaces based on the type of residential development, and in some cases, the number of bedrooms in the development.

#### Variations to parking rates

In calculating the requirements for car parking provision, reference should also be made to the special provisions in Section E1.8 which identify circumstances where the requirements may vary in regards to:

- items of environmental heritage; and
- mixed use development.

### E1.4.2 Residential parking generation rates

The parking generation rates in Table 1 below set the maximum number of parking spaces to be provided for residential development.

**TABLE 1** Residential uses parking generation rates

Land use	Maximum parking generation rates
<b>Low density residential</b>	
Dwelling house	2 spaces <sup>1</sup>
Semi-detached dwelling	2 spaces per dwelling <sup>1</sup>
Dual occupancy	2 spaces per dwelling <sup>1</sup>
<b>Attached dwellings</b>	
Attached dwelling located in a heritage conservation area	2 spaces per dwelling <sup>1,2</sup>

<sup>1</sup> The second space may be a tandem space subject to precinct and streetscape character considerations.

<sup>2</sup> Onsite parking areas, parking structures and servicing areas such as loading facilities are not a mandatory requirement in heritage conservation areas. On-site car parking may only be permitted or required when the



Land use	Maximum parking generation rates
Attached dwelling not in a heritage conservation area	Same rates as for residential flat buildings and multi dwelling housing stated below <sup>1</sup>
<b>Residential flat buildings, manor houses, multi dwelling housing and multi dwelling housing (terraces)</b>	
<i>Spaces based on number of bedrooms per dwelling<sup>3</sup></i>	
Studio apartment <sup>4</sup>	0.5 space
1 bedroom	1 space
2 bedrooms	1.5 spaces
3 or more bedrooms	2 spaces
Visitors	0.25 spaces
<b>Mixed use development (residential component)</b>	
<i>Spaces based on number of bedrooms per dwelling<sup>3</sup></i>	
1 bedroom or studio apartment <sup>5</sup>	0.5 space
2 bedrooms	1 space
3 or more bedrooms	1.5 space
Visitors	0.2 spaces

### Providing fewer spaces than the number calculated using the parking generation rates

The rates in Table 1 are maximum parking rates. The maximum number of parking spaces may not be achieved on a site depending on the site and its context.

In particular, the desired future character, streetscape and garages controls in the residential chapters of this DCP (Part B) take precedence over the numeric parking rates in this chapter.

For example, a dwelling on a small or narrow lot may not achieve the maximum number of on-site parking spaces if the arrangement of the spaces cannot meet the character, streetscape and location of garage requirements for the precinct. This is particularly relevant in the R2 Low Density Residential zoned areas.

However, in other instances where the maximum number of parking spaces is not achieved, the parking provided should not be substantially below the maximum rates. Where less than the

---

specified controls in chapters Part C, chapters C1 (Paddington HCA) C2 (Woollahra HCA) and C3 (Watsons Bay HCA) are satisfactorily met.

<sup>3</sup> Round up to nearest whole number with halves (i.e. 0.5).

<sup>4</sup> A studio apartment is an apartment that does not have a wall separating the sleeping area from the main kitchen and living area, and is generally smaller in size than a 1 bedroom apartment.

<sup>5</sup> The number of parking spaces for 1 bedroom and studio apartments in the Double Bay Centre should be multiplied by the parking multiplier for non-residential uses in the Double Bay E1 zone.

maximum parking rate is proposed, justification must cover matters such as, but not limited to the matters listed in Section 1.2.2 (Matters the consent authority will consider).

Council will generally only support such proposals where the applicant can demonstrate that the development is unlikely to create significant additional demand for on-street parking in surrounding streets.

#### **Providing more spaces than the number calculated using parking generation rates**

Where an application proposes to provide more than the number of spaces specified in Table 1, justification must be provided and address such matters as, but not limited to:

- ▶ an explanation for additional residential parking demand based on lack of alternative transport options. For example, the proximity and frequency of public transport, availability of car share schemes, and topography;
- ▶ the impact of any increased building bulk on the streetscape;
- ▶ compliance with landscape area requirements;
- ▶ impact of any increased building bulk on the amenity of adjoining properties in terms of:
  - overshadowing
  - loss of views
  - overbearing appearance; and
- ▶ the amount of additional excavation and its impact on:
  - land form
  - structural integrity of structures and buildings on adjoining land
  - stability of land on the site and on adjoining sites
  - impact on water permeable ground surfaces arising from an increased building footprint and hard surface driveways.

## E1.5 Non-residential parking

### E1.5.1 Calculating required parking for non-residential uses

---

#### Non-residential parking generation rates

The parking generation rates in Table 2 set the minimum number of parking spaces to be provided for non-residential development. The parking rates are then modified by a multiplier if the development is located in a particular centre. The multipliers are set out in Table 3.

#### Variations to parking rates

In calculating the requirements for car parking for non-residential uses reference should also be made to the special provisions in Section E1.8, which identify circumstances where the requirements may vary in regards to:

- ▶ items of environmental heritage;
- ▶ mixed use developments;
- ▶ certain business zoned land in Paddington;
- ▶ business zoned land in Double Bay; and
- ▶ development for a health care professional in certain parts of Woollahra.

#### Change of use

Where there is an intensification of parking based on the parking rates of this chapter, the amount of parking required will equal the difference between the parking generated by the proposed development and the parking generated by the current use as calculated by the rates in this chapter.

#### Alterations and additions

For proposals involving additional floor space, required parking shall be calculated using the rate specified in this chapter.

#### New development

Where a building is to be totally demolished and replaced, parking will be provided at the rate specified in this chapter. No parking credits will be allowed for the current building and its use.

### E1.5.2 Non-residential parking generation rates

---

The base parking generation rates set out in Table 2 are calculated per unit of gross floor area of a development.

In addition to the controls in this part of the DCP, the parking provision must be consistent with the desired future character for the centre or precinct where the development is proposed. (Refer to the Part D of this DCP on the business centres for any streetscape requirements and considerations.)

**TABLE 2** Non-residential parking generation rates

Land use	Minimum parking generation rate
<b>Commercial land uses</b>	
Business premises	2.5 spaces per 100m <sup>2</sup>
Retail premises	3.3 spaces per 100m <sup>2</sup>
Entertainment facility	Parking rate to be determined on a site specific basis. A traffic and parking report must be submitted with applications for this use.
Food and drink premises <sup>6</sup>	7 spaces per 100m <sup>2</sup> Note: variations to these parking rates apply to restaurants or cafes in the Double Bay Centre and to certain business zoned land in Paddington (see Section E1.8).
Pub	Parking rate to be determined on a site specific basis. A traffic and parking report must be submitted with applications for this use.
Supermarkets	3.5 spaces per 100m <sup>2</sup>
Registered club	Parking rate to be determined on a site specific basis. A traffic and parking report must be submitted with applications for this use.
Bowling club	Parking rate to be determined on a site specific basis. A traffic and parking report must be submitted with applications for this use.
Office premises	2.5 spaces per 100m <sup>2</sup>
Hardware and building supplies Landscape and garden supplies Vehicle sales and hire premises <sup>7</sup> Veterinary hospital	3.3 spaces per 100m <sup>2</sup>
Tourist and visitor accommodation	3 spaces per 100m <sup>2</sup>
Bed and breakfast accommodation	One on-site parking space for the bed and breakfast accommodation. This is additional to the required car parking for the dwelling house, and subject to compliance with the precinct criteria for the location of garages.
Serviced apartment	See rates for residential flat buildings (Table 1)

<sup>6</sup> For restaurants or cafes, the calculation of ‘gross floor area’ includes any outdoor seating areas, court yards and any other locations where patrons will be served, but excludes footpath dining areas provided the proposal complies with Council’s policy for footway restaurants.

<sup>7</sup> Calculation of ‘gross floor area’ includes any outdoor display area.

Land use	Minimum parking generation rate
<b>Industrial land uses</b>	
General industry	2.7 spaces per 100m <sup>2</sup>
Light industry	3 spaces per 100m <sup>2</sup>
Vehicle body repair workshop	6.75 spaces per 100m <sup>2</sup>
Boat repair facility	6.75 spaces per 100m <sup>2</sup>
<b>Community land uses</b>	
Child care centre	
Staff parking <sup>8</sup>	0.5 spaces per 100m <sup>2</sup>
Community facility	2 spaces per 100m <sup>2</sup>
Educational establishment	1 space per 100m <sup>2</sup> On-site parking for disabled persons is to be provided at a minimum rate of 1 car space per 50 car spaces or part thereof.
Tertiary establishment	In addition to the above, on-site parking is provided for students at a rate of one car space per 10 students.
Emergency services facility	3 spaces per 100m <sup>2</sup>
Health services facility	2 spaces per 100m <sup>2</sup>
Health consulting rooms	4.5 spaces per 100m <sup>2</sup> Note: Variations to these parking rates apply to zoned land in the area bounded by Syd Einfield Drive, Edgecliff Road, Adelaide Street and Vernon Street, Woollahra (see Section E1.8.6).
Medical centre	5 spaces per 100m <sup>2</sup>
Place of public worship	Parking rate to be determined on a site specific basis. A traffic and parking report must be submitted with applications for this use.
Public administration building	2.5 spaces per 100m <sup>2</sup>

<sup>8</sup> This rate applies only to staff parking. Separate requirements for an on-site pick-up and drop-off area are set out in Part F of this DCP, Chapter F1 Child Care Centres.

Land use	Minimum parking generation rate
<b>Recreational land uses</b>	
Recreational facility (indoor)	2 spaces per 100m <sup>2</sup>
Marina <sup>9</sup>	0.6 spaces per wet berth 0.2 spaces per dry storage and swing mooring 0.5 spaces per marina employee

### E1.5.3 Parking multipliers

In some centres the base parking generation rate for non-residential uses is discounted to respond to the particular circumstances of areas in the municipality. These multipliers are set out in Table 3.

The multipliers take account of the availability of public transport or public parking facilities in an area, as well as reflect the planning strategies or policies which Council is pursuing for each centre or locality. The multipliers have been determined from an assessment of the car parking conditions in the area, and may be varied as car parking conditions and planning policies are reviewed.

The total number of parking spaces required following calculation of the multiplier should be rounded up to the nearest whole number.

Note: If the subject site is not located within a centre identified in Table 3, a multiplier does not apply.

<sup>9</sup> Where variation to required parking is sought, a traffic and parking report is to be submitted with the development application. The requirements of the report are specified in the DA Guide.

**TABLE 3** Parking multipliers for non-residential uses

Centre	Parking multiplier <sup>10</sup>
Watsons Bay E1 Zone	0.6
Vaucluse Village E1 Zone	0.7
Rose Bay Centre E1 Zone	0.7
Rose Bay South MU1 Zone	0.6
Rose Bay North MU1 Zone	0.7
Bellevue Hill at Bellevue Rd and Victoria Rd E1 Zone	0.7
Double Bay Centre E1 Zone	0.6
Edgecliff Rd, Woollahra E1 Zone	0.6
Queen Street precinct MU1 and R2 Zone, between Ocean St and Oxford St and Moncur St, between Rush and James St	0.7
Oxford Street MU1 Zone including adjoining MU1 zoned properties, but excluding 12-94 and 3 63 William Street	0.7
Five Ways, Paddington E1 Zone	0.7
Edgecliff Commercial Core E1 Zone and New South Head Road Edgecliff commercial corridor MU1 Zone	0.6

<sup>10</sup> The multiplier does not apply to the on-site pick-up area for a child care centre

## E1.6 Bicycle parking and end-of-trip facilities

This section lists the minimum bicycle parking rates required for residential, commercial or industrial land uses.

### E1.6.1 Calculating required bicycle parking

#### Change of use

Where there is an intensification of parking based on the parking rates of this chapter, the amount of parking required will equal the difference between the parking generated by the proposed development and the parking generated by the current use as calculated by the rates in this chapter.

#### Alterations and additions

For proposals involving additional floor space, required parking shall be calculated using the rate specified in this chapter.

#### New development

Where a building is to be totally demolished and replaced, parking will be provided at the rate specified in this chapter. No parking credits will be allowed for the current building and its use.

Objectives		Controls	
O1	To provide adequate and sufficient bicycle parking facilities for the purposes of encouraging active transport.	C1	Bicycle parking provision for all developments must adhere to minimum bicycle parking rates in Table 4.
		C2	Bicycle parking must comply with the provisions and intent of <i>AS 2890.3 Bicycle Parking Facilities</i> in terms of security, accessibility and design specifications.
		Note: To assist with the design and installation of bicycle parking and end-of-trip facilities applicants and consultants should refer to the Austroads publication AP-R527-16 <i>Bicycle Parking Facilities: Guidelines for Design and Installation</i> .	
O2	To provide sufficient end-of-trip facilities for non-residential land uses.	C3	One secure locker is provided for each bicycle parking space.
		C4	One shower and change cubicle is provided for between 5 and up to 10 bicycle parking spaces, two showers and change cubicles for 11-20 bicycle parking spaces and one



Objectives		Controls	
			additional shower and cubicle for each additional 10 bicycle parking spaces.
O3	To provide parking facilities for electric bicycles.	C5	A charging point is provided for every five bicycle parking spaces.

## E1.6.2 Bicycle parking rates

Table 4 below lists the on-site bicycle parking rates required for various land uses.

**TABLE 4** Bicycle parking rates

Land use	Minimum bicycle parking rates <sup>11</sup>	
	Residents/Employees	Customers/Visitors
<b>Residential</b>		
Residential accommodation <sup>12</sup>	1 per dwelling	1 per 10 dwellings
<b>Tourist and Visitor Accommodation</b>		
Serviced apartments, hotel or motel accommodation	1 per 4 staff	1 per 20 rooms
Backpackers' accommodation	1 per 4 staff	1 per 10 beds
<b>Commercial</b>		
Office / business premises	1 per 150m <sup>2</sup> GFA	1 per 400m <sup>2</sup> GFA
Bulky goods premises	1 per 600m <sup>2</sup> GFA	1 per 1,000m <sup>2</sup> GFA
Shop, restaurant or cafe	1 per 250m <sup>2</sup> GFA	2 + 1 per 100m <sup>2</sup> over 100m <sup>2</sup> GFA
Shopping centre	1 per 200m <sup>2</sup> GFA	1 per 1,000m <sup>2</sup> GFA
Pub	1 per 100m <sup>2</sup> GFA	1 per 100m <sup>2</sup> GFA
Entertainment facility	-	Greater of 1 per 15 seats or 1 per 40m <sup>2</sup> GFA

<sup>11</sup> Round up to nearest whole number with halves (i.e. 0.5).

<sup>12</sup> Residential uses with individual garages or secure storage spaces for each dwelling that can accommodate a Class 1 bike locker under AS2890.3 Part 3: *Bicycle parking* will not require additional space for bicycle parking.

Land use	Minimum bicycle parking rates <sup>11</sup>	
	Residents/Employees	Customers/Visitors
Place of public worship	-	Greater of 1 per 15 seats or 1 per 40m <sup>2</sup> GFA
<b>Industry</b>		
Industry, warehouse or distribution centre	1 per 10 staff	-
<b>Community</b>		
Child care centre	1 per 10 staff	2 per centre
Health care facilities and hospitals	1 per 15 staff	1 per 200m <sup>2</sup>
Medical centre, health consulting rooms	1 per 5 practitioners	1 per 200m <sup>2</sup> GFA
Educational establishments	1 per 10 staff	1 per 20 students
Tertiary educational institution	1 per 10 staff	1 per 10 students
Recreation facilities (indoor) and Recreation facilities (outdoor)	1 space per 15 staff	1 per 15
Swimming pool	1 per 10 staff	1 per 40m <sup>2</sup> of recreation area
Community facility	1 per 10 staff	2 + 1 per 200m <sup>2</sup> of GFA

In addition:

- Where a proposed use is not included in the table above, an applicant is to provide bicycle facilities according to Council requirements.

## E1.7 Motorcycle parking rates

Motorcycles are defined as any powered two-wheel vehicle, including motorbikes, scooters and mopeds.

### E1.7.1 Calculating required motorcycle parking

#### Change of use

Where there is an intensification of parking based on the parking rates of this chapter, the amount of parking required will equal the difference between the parking generated by the proposed development and the parking generated by the current use as calculated by the rates in this chapter.

#### Alterations and additions

For proposals involving additional floor space, required parking shall be calculated using the rate specified in this chapter.

#### New development

Where a building is to be totally demolished and replaced, parking will be provided at the rate specified in this chapter. No parking credits will be allowed for the current building and its use.

Objectives		Controls	
O1	To provide adequate and sufficient motorcycle parking	C1	Developers shall provide a minimum of 1 motorcycle parking space per 10 car spaces for all types of development. <sup>13</sup>
		C2	Motorcycle parking spaces must have a minimum dimension of 1.2m x 2.5m.
		C3	Motorcycle parking areas shall be located close to the pedestrian access of the development.

<sup>13</sup> Round up to nearest whole number with halves (i.e. 0.5).

---

## E1.8 Variations to the parking generation rates

### E1.8.1 Application of variations

---

The variations to parking generation rates in section E1.8 apply to car parking, bicycle parking and motorcycle parking.

### E1.8.2 Items of the environmental heritage

---

In considering a development application involving a heritage item listed in Schedule 5 of Woollahra LEP 2014, Council may vary the parking requirements of this chapter, but only if conservation of the heritage values relies on the variation.

Under clause 5.10 (4) of Woollahra LEP 2014, the consent authority must, before granting consent in respect of a heritage item or heritage conservation area, consider the effect of the proposed development on the heritage significance of the item or area concerned.

### E1.8.3 Mixed use developments

---

For mixed use developments, Council may support a reduction in the total required number of non-residential parking spaces where the applicant can demonstrate to the satisfaction of Council that:

- ▶ overlapping parking demand will occur for different uses; or
- ▶ complementary use of spaces will occur for uses with different peak parking demand times.

### E1.8.4 Certain land in Paddington zoned MU1 Mixed Use

---

This section applies to land zoned MU1 Mixed Use in the Paddington business precinct in Oxford Street and the streets adjoining and in the vicinity of Oxford Street, excluding land at 12-94 and 3-63 William Street, 83 and 85 Underwood Street and 2 Hopetoun Avenue.

#### Change of use to a shop

Council will not require additional off-street parking for a change of use from a shop to another shop, or from a commercial premise to a shop, provided the proposal is within an existing building.

The area of a premises used for ancillary purposes such as storage, staff amenities, offices, fitting rooms and workrooms, will not be included as floor area for the purposes of car parking calculations.

---

### Change of use to a restaurant or cafe

Council will not require additional off-street parking for proposals within an existing building and its site (such as an external courtyard) involving a change of use from a shop or commercial premises to a restaurant or café.

## E1.8.5 Business zoned land in Double Bay

---

This section applies to land within the Double Bay Centre as identified in Chapter D5 Double Bay Centre of this DCP.

### Change of use

Council will not require additional off-street car parking or require a contribution under Council's Section 94 Contributions Plan for a change of use, provided the proposal does not result in a net increase in gross floor area.

### Change of use: restaurants or cafes

Council will not require additional off-street parking for proposals within an existing building and its site (such as an external courtyard) involving a change of use from a shop or commercial premises to a restaurant or café.

### Footpath dining

Council will not require additional off-street car parking or require a contribution under Council's Section 94 Contributions Plan for proposed outdoor eating areas on public footpaths, provided the proposal complies with Council's policy for footway restaurants.

### Studio and one bedroom apartments

The calculation of on-site parking for studio and one bedroom apartments is to include the parking multiplier for non-residential development as specified in Section E1.5.3.

## E1.8.6 Health care professional uses in Edgecliff Road, Adelaide Street and Vernon Street, Woollahra

---

For residential zoned land in the area bounded by Syd Einfield Drive, Edgecliff Road (southern side), Adelaide Street (western side) and Vernon Street (both sides) the rate in Table 2 does not apply. Instead the maximum number of spaces to be provided is:

- ▶ 1 space for 1 health care professional; and
- ▶ 2 spaces for 2 or 3 health care professionals.

## E1.9 Special provisions

### E1.9.1 Car parks with 20 or more spaces

Where more than 20 car parking spaces are provided on-site, the parking is to be accommodated undercover or in a basement area. This requirement applies to both residential and non-residential development.

(Refer to Part E of the DCP, Chapter E2 Stormwater and Flood Risk Management for flood planning levels associated with below ground parking.)

### E1.9.2 Car share

Car sharing services allow a large number of people to utilise the same vehicle at different periods, reducing the number of vehicles and parking spaces required while still providing the benefits of car ownership.

Objectives		Controls	
O1	To reduce the reliance on private vehicles and the corresponding traffic impact on the road network	C1	On-site car share may be permitted on a site-by-site basis at the discretion of Council. Each car share parking space has the potential to replace a maximum of 4 regular car parking spaces.
O2	To facilitate public use of car share vehicles	C2	Where a commercial car share space is proposed, the applicant is to include a letter from a commercial car share operator confirming their intention to place a car share vehicle within the development.
O3	To increase uptake and awareness of car share vehicles		
		C3	Nominated commercial car share spaces must be placed in publicly accessible locations within the development.

---

### E1.9.3 Tandem parking

---

Tandem parking is generally not preferred by Council but will be considered it in exceptional circumstances.

In residential development, tandem parking will only be permitted if the two spaces in tandem are allocated to a single dwelling.

In non-residential developments, the use of tandem parking to satisfy long stay parking demand requirements may be permitted where it is not physically possible to provide parking spaces in a side-by-side configuration. However, the tandem spaces must be for employee use only.

Tandem spaces must satisfy the parking and access design standards in Section E1.10.

---

### E1.9.4 Health consulting rooms

---

The following requirements apply to medical consulting rooms:

- ▶ Parking areas should be provided at the rear of properties. These areas may be covered only if they meet all relevant heritage conservation area controls, residential precinct controls and general development controls.
- ▶ Parking areas, either covered or uncovered, may be provided at the front of properties but only if they meet all relevant heritage conservation area controls, residential precinct controls and general development controls.
- ▶ Parking areas are not to be enclosed by gates, doors or roller shutters during business hours. Requirements may be imposed by Council in relation to boundary fencing to facilitate vehicular access to parking spaces.
- ▶ Parking areas to serve medical consulting rooms are to be landscaped in accordance with a landscape plan. Applicants should contact Council's Open Space and Trees section to determine appropriate plant species for landscaping purposes.

---

### E1.9.5 Parking spaces for people with a disability

---

- ▶ Accessible parking spaces must be provided at a rate in accordance with Part D3.5 of the Building Code of Australia.
- ▶ Council may require additional parking spaces for people with disabilities above the rates stated in Part D3.5 of the Building Code of Australia as a condition of consent.

---

### E1.9.6 Small car parking spaces

---

- ▶ Small car parking spaces are permitted in public car parks but must constitute less than 5% of the overall number of parking spaces.
  - ▶ Dimensions for small car parking spaces must be in accordance with Australian Standard AS/NZS 2890.1 Off-street car parking.
-

---

### E1.9.7 Resident Parking Scheme (RPS) Areas

---

Resident Parking Schemes (RPS) provide preferential access to on-street parking for residents who do not have sufficient off-street parking. Where a development increases dwelling density, extending the RPS to new residents may lead to an under-supply of on-street car parking. To avoid this, occupants of the additional dwellings are not eligible for on-street parking permits.

- ▶ Where a development increases dwelling density, occupants of the additional dwelling(s) are not permitted access to resident parking schemes.

## E1.10 Parking and access design standards

### E1.10.1 Design and use of parking areas

---

Parking areas are to be designed to function solely for the purpose of parking vehicles. Space for waste receptacles and storage should be located so that it does not reduce the amount and effective operation of parking.

### E1.10.2 Australian Standards

---

The following minimum requirements are based on the Standards Association of Australia, and Council's experience with development in the Municipality.

In implementing this DCP the following Australian Standards<sup>14</sup> apply for the design of parking and loading facilities, unless otherwise specified:

- ▶ AS/NZS 2890.1 Part 1: Off-street car parking;
- ▶ AS 2890.2 Part 2: Off-street commercial vehicle facilities;
- ▶ AS 2890.3 Part 3: Bicycle parking;
- ▶ AS 2890.5 Part 5: On-street parking; and
- ▶ AS/NZS 2890.6 Part 6: Off-Street parking for people with disabilities.

The size of parking bays, the width of the aisles and the location of columns, poles, walls or other physical barriers are to be based on providing adequate manoeuvring area for access to parking bays and adequate clearance for opening vehicle doors once the vehicle is parked.

### E1.10.3 Car parking space and bay size

---

Minimum bay width and length dimensions are to comply with AS/NZS 2890.1 and AS 2890.2.

---

<sup>14</sup> The most recent version of Australian Standards should be used.

---



---

### E1.10.4 Ramps and primary aisles

---

The minimum dimensions for the design of ramps and primary aisles which do not have direct access to or from parking bays are shown in AS/NZS 2890.1 - Section 2.5 Design of Circulation Roadways and Ramps.

The ramp grading is to be designed to ensure that the breakover angle coming onto, or off, a ramp is not so severe as to cause scraping of a vehicle undercarriage. Design of ramps and gradients will be consistent with AS/NZS 2890.1.

### E1.10.5 Turning paths

---

The design of turning paths for manoeuvring, parking space access and aisle designs are set out in AS/NZS 2890.1 Appendix B Section B3 Swept Paths for cars (for the B85 vehicle) and AS 2890.2 Part 2: Off-section street commercial vehicle facilities.

Some laneways or narrow streets do not have sufficient turning space for B85 vehicles. The removal of on-street parking to establish a turning space into private property should be avoided and will only be considered in the following circumstances:

- ▶ no more than a maximum of 5.4m of on-street parking, measured at the kerb line, is removed to provide for a turning space;
- ▶ the use and quantity of the remaining on-street parking spaces is not adversely affected; and
- ▶ 5.4m is a maximum. If Council can demonstrate that a B85 vehicle can access and egress the site with the removal of less than 5.4m of on-street parking, then this lesser amount is all that will be approved.

Consideration will be given to the approval of proposed off-street car parking spaces (as set out in AS/NZS 2890.1) that are unable to be accessed by a B85 vehicle in private car parks in relation to the above points only if:

- ▶ the site is in the Paddington or Woollahra Heritage Conservation Area see Part C, Chapters C1 and C2), and
- ▶ the site has rear lane access, and
- ▶ no on-street parking is lost (i.e. the zero net loss argument cannot be applied), and
- ▶ all applicable controls in Part C Chapters C1, and C2 are met to the Council's satisfaction.

Note: On-site parking in the Paddington and Woollahra Heritage Conservation Areas is not mandatory. On-site parking may only be permitted or required when specified controls set out in Part C Chapters C1 (Paddington HCA) and C2 (Woollahra HCA) are satisfactorily met.

### E1.10.6 Driveways and access points

---

The following requirements apply to the siting and design of driveways:

- ▶ The design of driveways and access points, except for dwelling houses, is to be such that vehicle entry and exit from a site, onto a public road, is made by driving in a forward direction, unless otherwise required by Council.
- ▶ All driveways, except for dwelling houses, are signposted indicating 'IN/ENTRANCE', 'OUT/EXIT' and 'KEEP LEFT' as appropriate.
- ▶ Driveways are situated so that any vehicle turning from, or into, the street can be readily seen by the driver of an approaching motor vehicle or pedestrian.
- ▶ Access driveway locations comply with Figure 3.1 in Section 3.2.3 of AS/NZS 2890.1.
- ▶ Driveway splays shall be provided in accordance with Figure 3.3 in Section 3.2.4 of AS/NZS 2890.1. Exceptions to this may be accepted in the following circumstances:
  - for dwelling house, dual occupancies and attached dwellings in residential zones in low pedestrian activity locations<sup>15</sup> a fence to a maximum height of 0.9m is permitted in the splay area.
  - where an object in the adjoining property creates an obstruction to visibility within the splay area.

Note: Driveway construction on Council's roads will require the submission of a Section 138 of the *Roads Act 1993* application. The form is available on the Council website. A copy of Council's standard drawing for driveways is available with the application.

- ▶ The width of internal access driveways are to comply with Section 3.2 of AS/NZS 2890.1 regarding driveway access requirements. Wider internal driveway widths may be acceptable depending on the site conditions. A passing bay is to be provided where the driveway length exceeds 40m.
- ▶ Vehicular access to an ancillary dwelling is provided from the same vehicular crossing for the principal residence.
- ▶ Where possible, all car parking and garage structures are located at the rear, with access from the rear lane or side driveway.
- ▶ Car parking and driveway areas are located and designed to:
  - enable the efficient use of car spaces and accessways, including safe manoeuvrability for vehicles between the site and street;
  - fit in with any adopted street hierarchy and objectives of the hierarchy and with any related local traffic management plans;
  - preserve significant trees and vegetation; and
  - complement the desired future character for the locality as described in the residential chapters of this DCP.
- ▶ Vehicle crossings are constructed at an angle of 90° to the carriageway of the road. Vehicle crossings must take the shortest route across the footpath, between the kerb and boundary.

---

<sup>15</sup> Low pedestrian activity locations are areas away from schools, commercial centres or other locations that generate pedestrian activity.

- 
- ▶ The width of vehicle crossings is minimised so as to retain on-street parking. Footpath crossings will not be permitted where:
    - One off-street parking space will result in the loss of two on-street parking spaces. For example, where the street is narrow with parking on both sides.
    - The provision of off-street parking will result in the loss of a significant tree.
  - ▶ Vehicle crossings are located to minimise the loss of useable on-street parking. That is, they are located immediately adjacent to the adjoining property's vehicle crossing (0m) or a minimum distance of one on-street car parking space (5.4m) from any existing driveway crossing.

### E1.10.7 Signposting

---

Parking areas, including visitor parking spaces, should be well signposted to indicate the availability of off-street parking, with entry and exit points clearly visible from both the street and the site.

Pavement bay delineation, arrows and other pavement markings are to be marked using white paint. Details of all proposed signposting and linemarking of parking areas are to be submitted with the development application.

### E1.10.8 Landscape plan

---

A landscape plan should be submitted with the development application showing the dimensions, levels, existing vegetation and position, type and characteristics of all proposed landscaping and plant material.

In particular, the plan should address the following:

- ▶ Screening: Uncovered car parking areas should be adequately and appropriately screened and landscaped by the planting of shrubs and shade trees.
- ▶ Water runoff: An open texture surface material should be used to reduce water run-off from parking areas.

### E1.10.9 Drainage of car parking areas

---

Drainage of car parking areas must be consistent with Council's provisions in Part E of the DCP, Chapter E2 Stormwater and Flood Risk Management.

## E1.11 Electric vehicle charging points

The controls for electric vehicle charging points encourage and support the increased use of electric vehicles by ensuring the installation of appropriate electric circuitry and dedicated electric vehicle charging points.

Two types of electric vehicle charging levels have been considered:

- ‘Level 1’ charging consisting of a regular, single phase power point.
- ‘Level 2’ charging consisting of a single or three-phase power point with a power range of 7kW-22kW, as defined by the NSW Electric and Hybrid Vehicle Plan, Future Transport 2056 (21 January 2019). ‘Level 2’ electric vehicle charging provides a superior, faster and more stable charging option.

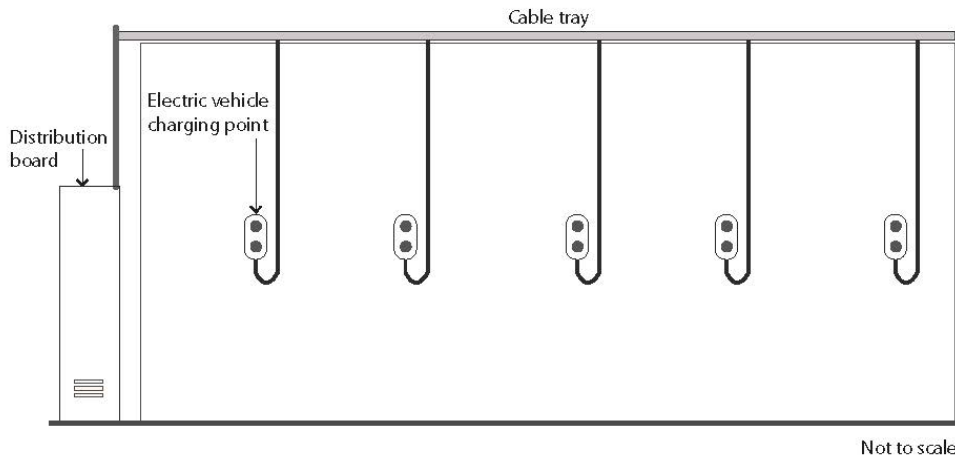
The controls will require all types of residential and non-residential development to be designed and constructed with appropriate electrical infrastructure to facilitate the future installation of electric vehicle charging points.

For certain types of residential and non-residential development a minimum number of ‘Level 2’ electric vehicle charging points must be installed.

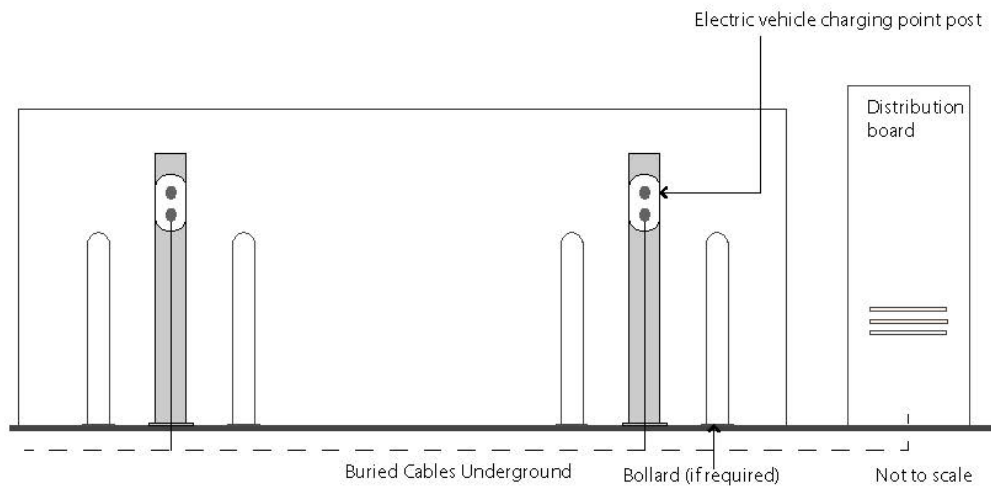
Objectives	Controls
<p>O1 To encourage and support increased usage of electric vehicles.</p>	<p>C1 Electric circuitry to accommodate ‘Level 2’ electric vehicle charging points must be integrated into all off-street car parking of new residential and non-residential development to ensure that 100% of car spaces can install electric vehicle charging points in the future. This must include:</p> <ul style="list-style-type: none"> <li>a) Ensuring adequate electrical capacity and infrastructure (cable size, distribution board size etc.) for the electric vehicle charging point system; and</li> <li>b) Providing either buried cables underground or cable trays sufficient to accommodate electric circuitry to each car space (see Figure 1 and Figure 2).</li> </ul> <p>C2 Minimum electric circuitry for a ‘Level 2’ electric vehicle charging point is required to be:</p> <ul style="list-style-type: none"> <li>a) Privately available spaces: ‘Level 2’ slow - single phase with 7kW power; and</li> </ul>

Objectives	Controls
	<p>b) Publicly available spaces: ‘Level 2’ fast - three-phase with 11-22kW power.</p> <p>C3 The installation of a ‘Level 2’ electric vehicle charging point is encouraged for new dwelling houses, semi-detached dwellings or dual occupancies.</p> <p>C4 All new residential and non-residential development (other than for dwelling houses, semi-detached dwellings or dual occupancies) must provide 1 car parking space or 10% of all car parking spaces - whichever is greater - to have a ‘Level 2’ electric vehicle charging point installed.</p>

**Figure 1:** Electric vehicle charging points and electric circuitry provision in development with multiple car spaces using cable tray system.



**Figure 2:** Electric vehicle charging points and electric circuitry provision in development with multiple car spaces using buried underground cable system.



## E1.12 Green Travel Plans

A green travel plan provides information to users of the development on how to reach the site via active and public transport. Usually only developments of significant size require a green travel plan. However, any developer may elect to provide a green travel plan to reduce vehicle use.

Objectives		Controls	
O1	To ensure green travel plans are provided with certain developments.	C1	Developments which exceed the threshold values listed in Section E1.12.1 will require a green travel plan.
O2	To ensure the targets set out by the green travel plan are reasonable and practical.	C2	Council will review the targets laid out by the green travel plan before implementation.
O3	To ensure responsibility for implementing the green travel plan is held by a representative within the organisation or company.	C3	The address and contact details of a contact person shall be provided. The contact person will be responsible for implementing and enforcing the green travel plan.
O4	To monitor and review the effectiveness of the green travel plan.	C4	After implementation of the green travel plan, annual reports will be required to provide information on the number of people trips, travel modes by time of day, journey purpose and

---

Objectives	Controls
	origin/destination of trips for a minimum of 5 years post occupation.

### E1.12.1 Green travel plan thresholds

---

A green travel plan is required for development listed below:

- ▶ Educational establishments allowing an additional 100 students.
- ▶ Non-residential developments with a gross floor area of 2,000m<sup>2</sup> or more.
- ▶ Residential developments which provide 50 or more additional dwellings.

---

## E1.13 Operational traffic management plan

Operational traffic management plans are required for certain major developments that are likely to impose a significant impact on the surrounding road network.

### E1.13.1 Operational traffic management plan for non-residential developments

---

An operational traffic management plan (OTMP) is required for developments under clause 104 and Schedule 3 of *State Environmental Planning Policy (Infrastructure) 2007* or classified as designated developments under s.77A of the EP&A 1979.

Otherwise, Council may require an OTMP for the following developments:

- ▶ Child care centres.
- ▶ Drive-in take-away food outlets.
- ▶ Education facilities.
- ▶ Entertainment facilities.
- ▶ Health care facilities.
- ▶ Hotel and motel accommodation.
- ▶ Industrial premises.
- ▶ Public car parks.
- ▶ Places of public worship.
- ▶ Pubs.
- ▶ Recreation and tourist facilities.
- ▶ Registered clubs.
- ▶ Retail premises comprising supermarkets and or shopping centres.
- ▶ Service stations.
- ▶ Other developments. (Generally if there is significant expansion or modification).

### E1.13.2 Details an operational traffic management plan

---

The minimum details for an operational management plan are:

- ▶ Existing and proposed traffic generation.
- ▶ Information on the existing and proposed road network, routes and access locations.
- ▶ Details of site operations including peak hours, speed zones and forecast traffic flows.
- ▶ On-street/off-street parking.
- ▶ Details on public and active transport.



- ▶ Traffic control plans (if required).

## E1.14 Off-street loading and servicing facilities

Off-street loading and servicing arrangements may need to be provided for businesses, commercial, industrial, office, retail and storage uses, and any other use where regular deliveries of goods are made to or from the site.

### E1.14.1 Number of loading bays required

The following developments will generally be required to provide a minimum of one loading bay:

- ▶ retail premises (such as a supermarket) that require delivery of large items or pallets of goods;
- ▶ hotel, motel or serviced apartment accommodation;
- ▶ registered clubs or bowling clubs;
- ▶ hardware, building, landscape and garden supplies;
- ▶ warehouse or distribution centre;
- ▶ food and drink premises or pubs with a seating capacity of 50 persons;
- ▶ bulky goods premises;
- ▶ educational establishments;
- ▶ emergency services or health services facilities; and
- ▶ marinas or boat repair facilities.

Council may require additional or less loading bays depending on the scale and type of use, having particular regard to the anticipated volume and frequency of deliveries associated with the proposed development, and the availability and suitability of any existing on street 'loading zone' located directly in front of, or at the side of, the premises.

### E1.14.2 Location and design of loading bays

- ▶ Loading bays and service areas should operate independently of other parking areas and should be situated to ensure that all service vehicles stand entirely on the site of the premises during loading and unloading operations.
- ▶ Vehicles will generally be required to enter and exit the site in a forwards direction.
- ▶ Service areas and loading docks should be designed to cater for the vehicles and servicing operations anticipated to occur in a particular development. Loading facilities and service areas should be visually unobtrusive and preferably:
  - located via a rear lane or side street, where such access is available;
  - located within the building envelope; and
  - designed to be perpendicular to lane frontage.

- ▶ Designs should comply with AS 2890.2 Part 2: Off-street commercial vehicle facilities and should accommodate the largest design vehicle to service the site.

## E1.15 Mechanical parking installations and paid parking stations

### E1.15.1 Locations and land use

Mechanical parking installations such as car lifts and car stackers are generally not desirable, and will only be considered in exceptional circumstances.

Mechanical parking installations may be permitted for residential and non-residential development where one or more of the following applies:

- ▶ The topography or lot size does not reasonably allow a simpler, more conventional parking arrangement.
- ▶ An existing building is being refurbished and there is no land available for additional parking. Refurbishment does not include extension of the building so as to increase site coverage or any other works to increase site coverage, all of which have the effect of reducing site area which could be used for conventional parking arrangements.
- ▶ In the case of non-residential development, the installations are for long-stay parking.
- ▶ In the case of residential development, the installations are for resident rather than visitor parking.

### E1.15.2 Compliance with the Australian Standards

Vehicle access to the mechanical parking installation must be made in accordance with AS/NZS 2890.1 (2004).

Where there is one car lift proposed, this must be capable of accommodating a B99 vehicle.

Where multiple car lifts are proposed, one car lift must be capable of accommodating a B99 vehicle and the remaining lifts must be capable of accommodating a B85 vehicle.

### E1.15.3 Waiting bays

- ▶ The design must include sufficient size to ensure that vehicles queuing to enter the mechanical parking installation or paid parking station does not extend beyond the property boundary. Vehicles must not wait on the footpath or roadway.
- ▶ The waiting bay(s) must be adequately sized to enable vehicle(s) to wait, while another vehicle exits the site. It is not acceptable for waiting vehicle(s) to reverse onto the footpath to enable another vehicle to manoeuvre off the site.
- ▶ The minimum length of each waiting bay is 6m.
- ▶ Waiting bays must not exceed a maximum grade of 1 in 20 (5%).
- ▶ Waiting bays must not obstruct the driveway.

---

### E1.15.4 Car parks with more than 25 vehicles

---

If a car lift is providing access to a car parking area with more than 25 parking spaces, then two separate car lifts must be provided.

### E1.15.5 Residential visitor parking

---

Residential visitor parking must be provided external to the mechanical parking installation.

### E1.15.6 Access

---

Where a development is required to provide parking for people with a disability, a mechanical parking installation must allow people with a disability to exit in the event of breakdown or failure.

### E1.15.7 Development application information

---

A report from a suitably qualified traffic consultant is required for any development application that proposes a mechanical parking installation or paid parking station relating to the parking of three or more cars.

As a minimum, the report should provide a queuing analysis, taking into account:

- ▶ the proposed peak hour vehicle volumes;
- ▶ the service rate (in seconds) associated with the proposed parking equipment; and
- ▶ the number of on-site waiting bays required to accommodate the 98th percentile queue at peak traffic levels.

The development application should also include the following information:

- ▶ details of required servicing and ongoing maintenance;
- ▶ internal and external dimensions of the device;
- ▶ details of the noise output of the device; and
- ▶ manufacturer's documentation, including information on service rates.

# Chapter E2

## Stormwater and Flood Risk Management

Part E ► General Controls for All Development

CHAPTER E2 APPROVED ON 27 APRIL 2015  
AND COMMENCED ON 23 MAY 2015

Last amended on 6 December 2021



# Chapter E2 ► Stormwater and Flood Risk Management

## Contents

<b>E2.1</b>	<b>INTRODUCTION .....</b>	<b>1</b>
	E2.1.1 Land and development to which this chapter applies .....	1
	E2.1.2 Development types to which this chapter applies .....	1
	E2.1.3 Objectives .....	1
	E2.1.4 Definitions .....	2
<b>E2.2</b>	<b>STORMWATER DRAINAGE MANAGEMENT CONTROLS.....</b>	<b>3</b>
	E2.2.1 Introduction .....	3
	E2.2.2 Water sensitive urban design .....	4
	E2.2.3 Stormwater treatment .....	6
	E2.2.4 On site detention (OSD) of stormwater .....	8
	E2.2.5 Connection to Council’s drainage systems.....	11
	E2.2.6 Diversion of Council’s drainage .....	14
	E2.2.7 Structures over or near drainage lines and easements.....	15
	E2.2.8 Connection to Council’s parks, reserves, bushland and natural waterways; Sydney Harbour; and Sydney Water channels.....	16
	E2.2.9 Low level properties and easements .....	17
	E2.2.10 Groundwater (hydrogeology) .....	19
	E2.2.11 Absorption systems .....	24
	E2.2.12 Pump and sump systems.....	25
	E2.2.13 Charged or siphonic systems.....	27
	E2.2.14 Activities on a public road .....	27
<b>E2.3</b>	<b>FLOOD RISK MANAGEMENT CONTROLS .....</b>	<b>28</b>
	E2.3.1 Introduction .....	28
	E2.3.2 Information available from Council.....	28
	E2.3.3 Flood planning levels .....	29
	E2.3.4 Flood controls.....	32
	<b>APPENDIX 1 - DEFINITIONS .....</b>	<b>38</b>
	<b>APPENDIX 2 - DESIGN RAINFALL INTENSITIES.....</b>	<b>43</b>



## E2.1 Introduction

This chapter outlines provisions related to two key interrelated components:

- ▶ the management of stormwater drainage collected on and discharged from new developments; and
- ▶ the minimisation of flood related risks to person and property associated with the development and use of land.

In preparing an application for a development, both components must be considered.

### E2.1.1 Land and development to which this chapter applies

---

#### Stormwater drainage

This chapter applies to all land within the Woollahra Municipality.

#### Flood risk management

The flood risk management component of this chapter applies to all land within the Woollahra Municipality that is within a “flood risk precinct”.

### E2.1.2 Development types to which this chapter applies

---

This chapter applies to all development that requires consent.

This includes complying development under the NSW General Housing Code, and complying development for secondary dwellings under the *State Environmental Planning Policy (Affordable Rental Housing) 2009*.

### E2.1.3 Objectives

---

The objectives of this chapter are:

- 01 To encourage ecologically sustainable stormwater management and the use of water sensitive urban design.
- 02 To maintain existing natural drainage patterns.
- 03 To ensure that adequate provision has been made for the disposal of stormwater from land proposed to be developed.
- 04 To ensure the controlled release of stormwater to public stormwater systems without adversely impacting on adjoining or downstream properties.
- 05 To protect Sydney Harbour and its waterways from stormwater pollution.



- 06 To minimise flood risk and damage to people and property by setting appropriate development controls.
- 07 To ensure that flood levels are not increased by development.

### E2.1.4 Definitions

---

The definitions in Appendix 1 of this chapter define words and expressions for the purpose of this chapter.

These definitions apply in addition to the definitions in Part A Chapter A3 of the DCP, and any other terms referred to in Australian Rainfall and Runoff (Institution of Engineers, Australia, 1987), the Floodplain Management Manual (New South Wales Government, January 2011), the *Environmental Planning and Assessment Act 1979* (EP&&Act) or the Woollahra Local Environmental Plan 2014 (LEP).

## E2.2 Stormwater drainage management controls

### E2.2.1 Introduction

In assessing development applications for stormwater drainage management, Council will consider each of the matters listed below and each matter must be addressed by the applicant. The response to these matters, plus any other relevant statutory and policy matters, will be considered by Council when assessing the acceptability of the development.

For each matter, specific objectives are given together with the controls to achieve those objectives. Alternative ways to achieve the stated objectives will be considered when, in the opinion of Council, the outcome is better in terms of the impact on the public domain or adjacent properties than strict compliance with the stated controls.

High quality submissions greatly aid the assessment process and it is recommended that information regarding the matters below be prepared by a suitably qualified practitioner.

Stormwater drainage management is generally achieved through the provision of a stormwater drainage concept plan, which should address the following management measures (where applicable):

- ▶ water sensitive urban design;
- ▶ stormwater treatment;
- ▶ on site detention (OSD) of stormwater;
- ▶ connection to Council's drainage systems;
- ▶ diversion of Council's drainage;
- ▶ structures over or near drainage lines and easements;
- ▶ connection to Council's parks, reserves, bushland and natural waterways; connection to Sydney Harbour; and connection to Sydney Water channels;
- ▶ low level properties and easements;
- ▶ groundwater (or hydrogeology);
- ▶ absorption systems;
- ▶ pump and sump systems;
- ▶ charged or siphonic systems; and
- ▶ activities on a public road.

Information regarding these matters does not necessarily have to be of a standard and level of detail that is construction ready. In most cases a concept plan only is required at DA stage, with the detailed stormwater drainage design and specifications required prior to the issue of a Construction Certificate. The exception to this is stormwater works impacting on easements, where detailed stormwater drainage design and specifications are required at the DA stage.

---

## E2.2.2 Water sensitive urban design

---

### Objectives

- O1 To ensure development is designed, constructed and maintained so as to minimise impacts on the natural water cycle.
- O2 To reduce peak stormwater flows and total stormwater runoff volume.
- O3 To utilise water resources more efficiently.
- O4 To reduce the flood risk in urban areas.
- O5 To reduce erosion of waterways, slopes and banks.
- O6 To control stormwater pollution and improve water quality in Sydney Harbour, waterways and drainage systems.

### Controls

#### *Pervious surfaces*

- C1 In areas with suitable ground conditions, the use of pervious surfaces is encouraged.

#### *Rainwater tanks*

- C2 The use of rainwater tanks for non-potable water uses is encouraged.
- C3 Rainwater tanks only collect roof water.
- C4 Rainwater tanks are connected to all external non-potable water uses including landscaping. Tanks may be connected to internal non-potable water uses including toilet flushing and washing machines.
- C5 Where OSD is required onsite (see Section E2.2.4), overflow from rainwater tanks is directed to the OSD system.
- C6 Where OSD is not required onsite, overflow from rainwater tanks is directed to Council's drainage network.
- C7 Rainwater tanks are located to minimise their visual impact. Above-ground rainwater tanks are located behind the building line and suitably screened. Slimline rainwater tanks at the side of buildings or under hardstand areas such as driveways are preferred.

#### Note:

- ▶ Rainwater tanks must be installed by a licenced plumber in accordance with AS3500 National Plumbing and Drainage Code, HB230 Rainwater Tank Design and Installation Handbook, other relevant codes and the manufacturer's specifications
- ▶ A positive covenant will be required for maintenance of rainwater tanks.

***Greywater reuse***

C8 The reuse of domestic greywater for non-potable water uses is encouraged (e.g. water discharged from washing machines).

**Notes:**

- ▶ A report on the appropriate treatment to allow for the safe reuse of domestic greywater must be prepared by a suitably qualified practitioner and the design must be in accordance with appropriate industry standards.
- ▶ Industry standards include HB 326 Urban Greywater Installation Handbook and the guidelines prepared by the NSW Department of Primary Industries (Office of Water), the NSW Department of Health and the Federal Department of Sustainability, Environment, Water, Population and Communities.
- ▶ A positive covenant will be required for maintenance of systems to reuse domestic greywater.

***Green roofs***

C9 The use of green roofs is encouraged.

**Note:**

- ▶ Green roofs must be designed by a suitably qualified practitioner and in accordance with appropriate industry standards.
- ▶ Industry standards include the Building Code of Australia and the City of Sydney Council Green Roof Resource Manual guidelines.
- ▶ A positive covenant will be required for maintenance of green roofs.

---

### E2.2.3 Stormwater treatment

---

#### Objectives

- O1 To minimise the discharge of pollutants (litter, sediment, suspended solids, nutrients, oil, grease and toxants) from paved and other impermeable surfaces into Sydney Harbour, waterways and drainage systems.

#### Controls

##### *Stormwater treatment*

- C1 Stormwater treatment is required for:
- all properties with connections to Sydney Harbour, waterways and open watercourses;
  - all new commercial developments and residential flat buildings; and
  - all major alterations and additions to commercial developments and residential flat buildings.
- C2 The stormwater treatment system, such as a gross pollutant trap (GPT), meets the specifications outlined in the water quality targets below (see control C7 below).
- C3 All stormwater treatment systems are located wholly on private property.

Note: A positive covenant will be required for maintenance of the stormwater treatment system.

##### *Rain gardens*

- C4 Rain gardens are required for:
- new developments where the total site area is more than 500m<sup>2</sup>;
  - developments involving alterations and additions where the additional gross impervious area is greater than 40m<sup>2</sup> and the total site area is more than 500m<sup>2</sup>; and
  - developments where the car park has four or more above ground parking spaces.
- C5 Rain gardens are sized as follows:
- 10m<sup>2</sup> per 1000m<sup>2</sup> of site area for sites between 500m<sup>2</sup> and 2,000m<sup>2</sup>; and
  - for sites greater than 2,000m<sup>2</sup>, the size of the required rain garden is to be determined by a study completed by a suitably qualified practitioner.
- C6 Council may consider a reduction in the size of the required rain garden if the applicant provides a detailed study by a suitably qualified practitioner. The study is to demonstrate that an integrated approach to water sensitive urban design has been undertaken and that the development meets Council's water quality targets. As a consequence, Council may require the OSD minimum site storage requirements to be increased to 25m<sup>3</sup> per 1,000m<sup>2</sup>. See Section 2.2.4 below for OSD requirements.

**Notes:**

- ▶ Rain gardens are to be designed by a suitably qualified practitioner and must be designed in accordance with appropriate industry standards.
- ▶ Industry standards include the Monash University's Facility for Advancing Water Biofiltration Adoption Guidelines and the NSW Government's Catchment Management Authority Water Sensitive Urban Design Program.
- ▶ A positive covenant will be required for maintenance of the rain garden.

***Water quality targets***

C7 Water quality measures are installed that meet the following environmental targets for stormwater runoff leaving the site:

- a) 90% removal of gross pollutants (> 5mm);
- b) 85% removal of total suspended solids;
- c) 65% removal of total phosphorous; and
- d) 45% removal of total nitrogen.

C8 For developments creating high levels of pollutants, pollution modelling may be required.

**Note:**

- ▶ Pollution modelling may be undertaken with programs such as MUSIC - the Model for Urban Stormwater Improvement Conceptualisation.
- ▶ Discharge from car wash down bays, fire sprinkler test waters, trade wastes and wastes from air conditioning cooling towers are to be treated to Sydney Water's requirements and discharged to the sewer.

## E2.2.4 On site detention (OSD) of stormwater

### Objectives

- O1 To reduce and mitigate the peak stormwater flow from a developed site and allow the controlled release of stormwater to the public stormwater system.
- O2 To reduce flood risk in urban areas.

### Controls

#### *Where this applies*

- C1 OSD is required for:
  - a) new developments where the total site area is more than 500m<sup>2</sup>; and
  - b) developments involving alterations and additions where the additional gross impervious area is greater than 40m<sup>5</sup> and the total site area is more than 500m<sup>2</sup>.
- C2 Properties, regardless of the development type, located within Council's OSD exemption area are not required to install OSD.

Note: The map of Council's OSD exemption area is available on Council's website.

#### *Requirements*

- C3 OSD storage is designed in accordance with the storage/discharge relationships as shown in the table below.

OSD requirements per 1,000m <sup>2</sup> of the total site area		
Permissible site discharge (l/s)	Minimum site storage requirements (m <sup>3</sup> )	ARI (year)
24	4	1 in 2
34	20	1 in 100

Note: The above OSD requirements are based on a simplified design approach which has been prepared using preliminary permissible site discharge and site storage requirement values. This simplified design approach will provide benefits to developers by reducing the cost of detailed engineering calculations, remove ambiguity in design approaches and assumptions, provide a simple geometric approach and allow Council to easily review designs with the intent of reducing development assessment times.

- C4 Council may consider independent assessment for on-site detention requirements. The applicant is to submit to Council an OSD assessment report including all modelling and design calculations. Any alternative methodology must be prepared by a suitably qualified practitioner.
- C5 Where possible, the drainage system is designed to direct runoff from the entire site to the OSD system.

- C6 Where OSD is required for alterations and additions, OSD is provided for the entire site, not only the area of new works.
- C7 All OSD systems drain by gravity to Council’s drainage system.
- C8 An overland flow path, to convey water to the street in the event of a blockage or failure of the OSD outlet, is provided and is clearly identified in the design.
- C9 All OSD systems have a discharge limiter which is an appropriately sized short length of reduced diameter pipe or a non-removable orifice plate. The discharge limiter is enclosed by a rustproof screen or wire cage to protect against blockage.

***OSD location***

- C10 OSD storage is located as close as possible to the lowest point of the site and if possible at the property frontage so that any surcharge will overflow to the street.
- C11 Separate OSD is provided for each Torrens title dwelling.
- C12 For strata and subdivided properties, the OSD requirements outlined in controls C1 and C3 above apply to the property as a whole. OSD is generally located in common areas for strata title or community title subdivision.
- C13 The OSD structure is not established across property boundaries.

***Above ground storage***

- C14 The OSD system is visually unobtrusive and sympathetic with the development. It must not cause hazard or inconvenience to pedestrian or vehicle access.
- C15 A minimum 20% of the OSD storage requirement is incorporated as below ground storage.
- C16 OSD storage in landscaped areas requires an extra 20% volume to compensate for vegetation growth.
- C17 Pedestrian access paths are maintained above the 1 in 100 ARI operating level for any non-enclosed storage. Poned water depths do not exceed 200mm in parking/ driveway areas, and 300mm in courtyards/grass/landscape areas.
- C18 Adequate subsoil drainage is provided in the above ground OSD storage to retain the amenity of the area after a rainfall event.

***Below ground storage***

- C19 The structural design of the OSD storage is certified by a suitably qualified practitioner including the following design issues:
  - a) all structures in the zone of influence of the excavation are checked for structural adequacy;
  - b) buoyancy of the OSD storage is taken into consideration; and
  - c) the OSD structure is designed to all relevant Australian Standards and industry standards; and



d) A minimum slope of 1% is provided on the floor of the OSD storage.

Note: Industry standards include AS 2865 Safe Working in a Confined Space and any Work Cover requirements.

### ***Maintenance***

C20 The OSD system provides for easy access for inspection and maintenance. Generally, grated access points are preferred.

C21 A silt/ litter arrestor pit is located before the OSD storage and fitted with screens that can be easily removed for routine maintenance. The screen is of expanded steel mesh (e.g. Maximesh or similar). To assist in shedding debris, the screen is positioned no less than 45° to the horizontal. Pits are a minimum size of 0.6m x 0.6m.

Note: A positive covenant will be required for the maintenance of the OSD system.

### ***Alternatives to OSD requirements***

C22 A rainwater tank may be installed as an alternative to all or part of the OSD requirements for any development type. The capacity of the rainwater tank is 1.5 times the OSD volume requirements. See Section E2.2.2 for rainwater tank requirements.

C23 A green roof may be installed as an alternative to part of the OSD requirements for any development type. The OSD requirements may be reduced by 50% if a roof garden is provided on-site. The roof garden covers at least 50% of the development's total roof area. See Section E2.2.2 for green roof requirements.

Note: Where there are discrepancies between the volume of OSD storage required in this chapter and the volume of OSD storage required in BASIX, the total storage requirements is the higher of the two volumes.

---

## E2.2.5 Connection to Council's drainage systems

---

### Objectives

- O1 To maintain existing natural drainage patterns and to not move water from one catchment to another.
- O2 To minimise erosion and allow for sediment control.
- O3 To avoid the flooding of properties.
- O4 To protect existing Council drainage assets.
- O5 To discharge stormwater at the lowest point feasible within the same catchment.

### Controls

#### General

- C1 Concept plans for the on-site stormwater system showing the location of major elements of the proposed system are provided.
- C2 Full details of the proposed connection to Council's drainage system are provided.
- C3 Where an overland flow system is not available, the drainage system is designed to cater to a minimum 1 in 100 ARI event.
- C4 Where an overland flow system is available, the drainage system is designed to cater to a minimum 1 in 20 ARI event; and the drainage system, in combination with the overland flow system, is designed to cater to a minimum 1 in 100 ARI event.
- C5 All stormwater discharge to Council's drainage system is gravity fed (for low level properties see also Section E2.2.9).
- C6 Stormwater discharge to the sewer is not permitted.
- C7 The potential for failure of components of the stormwater drainage system (e.g. blockage or structural damage) is considered and provision made for the safe conveyance of flows should failure occur.
- C8 Private drainage is installed in accordance with the appropriate industry standards.
- C9 All works within the road reserve or Council owned property comply with Council's "Specification for Road Works, Drainage and Miscellaneous Works".
- C10 Pumps for the disposal of stormwater runoff are not be permitted except in the circumstances set out in Section E2.2.12.

#### Note:

- ▶ Where works, including stormwater works, are within a public roadway (including the footpath and nature strip areas), approval is subject to a separate application under Section 138 of the *Roads Act 1993*.

- 
- ▶ All construction costs associated with connection of the private stormwater discharge to Council's drainage system must be met by the applicant. The location of Council's drainage infrastructure is available by contacting Council's Drainage Engineer. The applicant is responsible for investigating and confirming the presence and suitability of Council's drainage system for connection. The applicant is responsible for investigating and confirming the presence of services and utilities within the road reserve (e.g. electricity, gas and water).
  - ▶ Private drainage industry standards include AS3500 National Plumbing and Drainage Code, other relevant codes and the manufacturer's specifications.

### ***Connection to Council's below ground drainage***

#### *Where this applies*

- C11 In general, the stormwater drainage discharge from development sites is connected to Council's below ground drainage system.
- C12 Where there is no Council drainage system located adjacent to the site, the applicant must extend Council's drainage system to the site in order to permit the below ground connection.

#### *Requirements*

- C13 The connection from the development site to Council's below ground drainage system is a direct route and is generally laid perpendicular to the line of the kerb and gutter.
- C14 Stormwater drainage lines are located under the kerb and gutter where possible.
- C15 All connection pits are constructed in accordance with the appropriate industry standards.
- C16 No portion of the connection pipe intrudes into Council's pipe.
- C17 All stormwater pipes within the road carriageway are designed and installed to meet Council's specifications.
- C18 A standard Council double grated gully pit with 1.8m kerb lintel is constructed over the new line where it intersects with the private stormwater line. A capped pipe stub is provided to enable future extension of the line upstream.

#### *Notes:*

- ▶ Connection pit industry standards include AS3500 National Plumbing and Drainage Code, other relevant codes and the manufacturer's specifications.
- ▶ A closed circuit television (CCTV) inspection of any new connection must be carried out and submitted to Council with a works-as-executed plan.
- ▶ All stormwater pipes within the road carriageway must be at a minimum Class 2, 375mm diameter and have bedding to standard HS3, in accordance with AS3725 Loads on Buried Concrete Pipes. Rubber ring joints are required.

### *Exemptions*

- C19 An exemption from the requirement to discharge directly into Council's below ground drainage system may be considered where the required extension of Council's system is excessive. This exemption will be considered on a merit based assessment and factors to be considered include the magnitude of the development, extent of required works and the suitability of an alternative option.

### *Connection to Council's kerb and gutter*

#### *Where this applies*

- C20 Only dwelling houses and developments involving alterations and additions, where the additional gross impervious area is less than 40m<sup>2</sup>, may discharge stormwater to the kerb and gutter.

#### *Requirements*

- C21 The connection from the development site to Council's kerb and gutter is a direct route.
- C22 A maximum discharge rate of 20 l/s is permitted.
- C23 A maximum of one stormwater outlet per property is permitted.
- C24 Drainage conduits, across footpath areas that are discharging to the kerb, are designed and installed to meet Council's specifications.
- C25 Where the existing kerb is sandstone, the drainage discharge point is cored. The kerb is reinstated to match the existing form (e.g. bullnose, brick and sandstone).

Note: Drainage conduits, across footpath areas that are discharging to the kerb, must be 125mm x 75mm galvanised box or 65mm to 100mm sewer grade PVC pipes.  
A kerb adaptor must be provided for 80mm and 100mm PVC pipes.

### *Subsoil drainage*

- C26 All below ground structures with habitable or non-habitable floor spaces are fully tanked and do not require permanent dewatering.
- C27 All below ground structures are designed and installed in accordance with Council's Guide for preparing Geotechnical and Hydrogeological Reports.
- C28 Subsoil drainage does not discharged to Council's stormwater network, including stormwater pipes, pits and/or kerb and gutter.

## E2.2.6 Diversion of Council's drainage

---

### Objectives

- O1 There is to be no adverse impact on upstream or downstream properties.
- O2 There is to be no adverse impact on Council's drainage system.

### Controls

- C1 If an applicant proposes to divert Council's drainage the application is accompanied by a report, prepared by a suitably qualified practitioner, on the impacts of the diversion.
- C2 Where an overland flow system is not available, the diverted drainage system is designed to cater to a minimum 1 in 100 ARI event.
- C3 Where an overland flow system is available, the diverted drainage system is designed to cater to a minimum 1 in 20 ARI event; and the drainage system, in combination with the overland flow system, is designed to cater to a minimum 1 in 100 ARI event.
- C4 If Council's existing drainage system is diverted onto private land, an easement is created in favour of Council (see Section E2.2.9).

### Notes:

- ▶ A dilapidation report including a CCTV inspection of all drainage lines being impacted or diverted must be submitted with the construction certificate application. If the existing drainage line is in poor condition the drainage line is to be renewed and/ or refurbished.
- ▶ The location of the diverted drainage system must be fully accessible for future maintenance.

### E2.2.7 Structures over or near drainage lines and easements

#### Objectives

- O1 To provide for future maintenance activities on drainage lines.
- O2 To provide and maintain adequate overland flow paths.

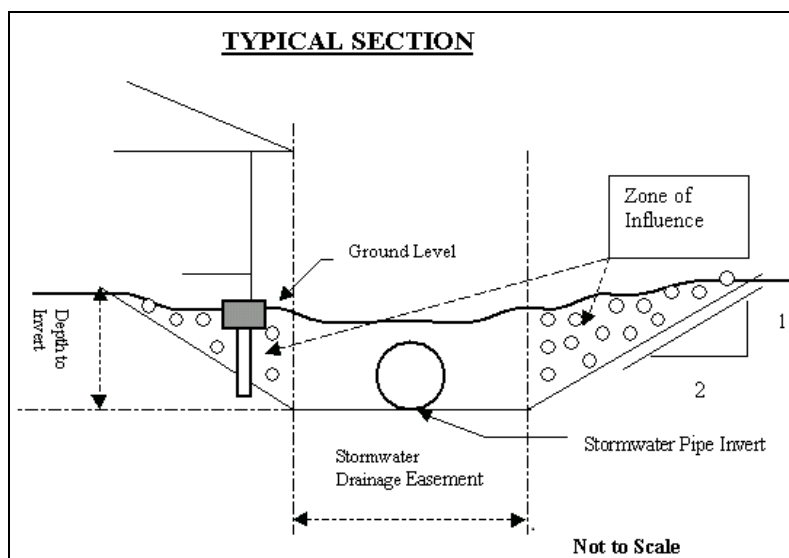
#### Controls

- C1 Generally, new buildings, structures and overhanging structures are not permitted over existing or proposed drainage lines and easements.
- C2 All structural foundations adjoining an easement or drainage line have a minimum depth lower than the invert of the adjacent drainage line. Additional depth is required for foundations adjoining natural water courses. All foundations are designed by a suitably qualified practitioner.
- C3 Overland flow paths are maintained over drainage lines and easements. Driveways and landscaped areas may be located on overland flow paths.

Note:

- Applications must include plans and details relating to structures near a Council drainage line or easement.
- A dilapidation report including a CCTV inspection of all drainage lines within 3m of any development structure must be submitted with the construction certificate application. If the existing drainage line is in poor condition the drainage line is to be renewed and/or refurbished.
- The applicant is to submit details on the proposed construction methodology to ensure that Council’s drainage system is protected and supported during any works.

**FIGURE 1** Typical section showing the zone of influence



---

## E2.2.8 Connection to Council's parks, reserves, bushland and natural waterways; Sydney Harbour; and Sydney Water channels

---

### Objectives

- O1 To manage, conserve and protect Council parks, reserves, bushland and natural waterways.
- O2 To maintain existing natural drainage patterns.
- O3 To minimise erosion of waterways, slopes and banks.
- O4 To control stormwater pollution and improve water quality in streams and groundwater.

### Controls

#### General

- C1 Stormwater discharge to a natural watercourse or Council below ground drainage line within a Council park, reserve or bushland may be permitted subject to a merits based assessment of the proposal by Council's Open Space and Trees Department.
- C2 An environmental impact assessment is submitted addressing the impact on the park, reserve or bushland during and after construction, environmental sensitivity, erosion potential and weed invasion potential.
- C3 Stormwater pipes and other structures are not visible on public land. Outlet structures are designed to blend in with the surrounds and should be constructed of natural materials, such as rock.

Note: Access through Council's park land and/ or storage of material on Council park land during construction will not be permitted unless prior written approval has been obtained from Council's Open Space and Trees Department.

#### *Discharge directly to Sydney Harbour*

- C4 Written approval from the Waterways Authority to discharge stormwater into Sydney Harbour is required.

Note: The applicant must seek this approval. The stormwater system must be designed in accordance with this DCP and any requirements of the Waterways Authority.

#### *Discharge to Sydney Water channels*

- C5 Written approval from Sydney Water to discharge stormwater from the subject property directly into Sydney Water drainage channels is required.

Note: The applicant must seek this approval. The stormwater system must be designed in accordance with this DCP and any requirements of Sydney Water.

---

## E2.2.9 Low level properties and easements

---

### Objectives

- 01 To maintain existing natural drainage patterns.
- 02 To ensure drainage discharge associated with new developments is gravity fed and does not require pumps to function.
- 03 To avoid nuisance and flooding.
- 04 To provide effective overland flow paths.
- 05 To protect existing Council drainage assets.
- 06 To discharge stormwater at the lowest point feasible within the same catchment.

### Controls

#### Requirements

- C1 Drainage discharge to Council's stormwater system is gravity fed. This may require the creation of an easement through the downstream property to discharge stormwater from the subject property.
- C2 Where an overland flow system is not available, the drainage system is designed to cater to a minimum 1 in 100 ARI event.
- C3 Where an overland flow system is available, the drainage system is designed to cater to a minimum 1 in 20 ARI event; and the drainage system, in combination with the overland flow system, is designed to cater to a minimum 1 in 100 ARI event.

#### Easements

- C4 Where easement consent is granted:
  - a) The easement is created on the certificate of title for all impacted properties.
  - b) The private drainage easement is of sufficient width to allow the required pipe to be installed and maintained.

Note: Any costs associated with investigating or establishing the easement are the responsibility of the applicant.

The applicant is responsible for negotiating with the downstream property owner to obtain a private drainage easement. It is not Council's role or within Council's jurisdiction to adjudicate on amounts of compensation. It is recommended that independent legal advice be sought.



Possible options available to acquire a private drainage easement include:

- ▶ by direct negotiation
- ▶ Section 88K of the *Conveyancing Act 1919*
- ▶ Section 40 of the *Land and Environment Court Act 1979*

The applicant must make a reasonable attempt to provide a gravity feed system to drain the site. The applicant must make formal approaches to all possible downstream property owners.

The applicant must attach a copy of the formal consent from the owner(s) of the intervening downstream property(s) with the development application.

The applicants must also engage a registered surveyor to prepare a plan of survey and the application for the easement must be lodged with the Land Titles Office with any necessary fees. Woollahra Council must be annotated as the Prescribed Authority on the Section 88K Instrument. A copy of the lodgement details must be provided to Council prior to operation of any development consent or activity application.

The requirement to obtain an easement may be waived if:

- ▶ written documentary evidence of refusal to permit an easement by the downstream owner has been provided to Council; and
- ▶ written documentary evidence of all reasonable attempts undertaken by the applicant to obtain an easement through the downstream property; and/or
- ▶ evidence is provided of any physical constraint that precludes a route for a downstream system.

For larger developments or developments in areas with known drainage problems, Council may require the applicant to pursue the acquisition of a downstream easement through the Land and Environment Court.

If an easement is not obtainable, it may be possible to connect to Council's below ground stormwater system if the Council system is extended to the site. See Section 2.2.5 above for requirements.

### ***Easement alternatives***

- C5 Easement alternatives will be considered only where the development involves alterations and additions to a dwelling house; and where the development increases the impervious area of the site by less than 40m<sup>2</sup>.
- C6 The following easement alternatives may be considered in the following circumstances:
- a) Where all roof drainage is drained to a rain tank designed to hold a volume of water and the tank only overflows once a year, on average. The minimum acceptable tank size is 60m<sup>2</sup> per 1,000m<sup>2</sup> of site area.  
Note: The applicant must submit full water balance calculations prepared by a suitably qualified practitioner.
  - b) Where an absorption dispersal system downstream of the rain tank and any paved areas is provided, and the absorption system is designed for a 20 year ARI storm. The rain tank is to be assumed to be full. See Section E2.2.11 for absorption system requirements.
  - c) Where the area is unsuitable for an absorption system, 20% extra storage volume is provided in the rain tank and a pump system may be installed. See Section E2.2.12 for pump system requirements.

Note: Council may reduce the storage requirements in heritage conservation areas if space is limited. This will be assessed on the merits of the application.

### ***Relationship to other properties***

- C7 Where surface runoff from adjoining properties currently flows onto the subject site, such flows are catered for within the development. Obstructions that cause damming and backwater effects on upstream properties will not be permitted.
- C8 Surface runoff from the subject site is not concentrated onto downstream properties.

### ***Existing Council stormwater***

- C9 Council will require the creation of an easement to its benefit over existing Council stormwater pipes, boxes or channels on private land.

## **E2.2.10 Groundwater (hydrogeology)**

---

### **Introduction**

Council will require geotechnical and hydrogeological reports for development applications which include below ground structures.

Any proposed development with below ground structures must consider the sub-surface conditions and the effects of construction on surrounding properties. In addition, those which are likely to extend below the level of seasonal fluctuations in the groundwater table, must also consider the effect of any changes induced in the sub-surface water levels and the groundwater flow patterns on surrounding properties. Unless site specific information exists to the contrary,

excavations deeper than 1m must be assumed to have this potential to intersect the groundwater level and shall be considered as below ground structures.

Council's principal objective is to ensure that earthworks and associated groundwater dewatering, during and after construction, will not have any adverse impacts on:

- ▶ Environmental functions and processes
- ▶ Neighbouring uses
- ▶ Cultural and heritage items
- ▶ Any features of the surrounding land and infrastructure that could be impacted by geotechnical and hydrogeological changes.

Typically, adverse geotechnical impacts may include vibration induces settlements from construction methods and equipment and inadequate support of adjacent land during and after construction. Typically, adverse hydrogeological impacts may include settlement induced by changes in the groundwater level and seepage problems.

## Objectives

- O1 To ensure that earthworks and associated ground water dewatering, during and after construction, will not have any adverse impacts on:
- Environmental functions and processes
  - Neighbouring uses
  - Cultural and heritage items
  - Any features of the surrounding land and infrastructure that could be impacted by geotechnical and hydrogeological changes.
- O2 To maintain the existing groundwater level, both during and after construction.
- O3 To minimise changes in groundwater level to protect surrounding property and infrastructure from damage.
- O4 Buildings must be designed and constructed with appropriate support and retention systems to ensure that:
- a) There will be no ground settlement or movement, during and after construction, sufficient to cause an adverse impact on surrounding properties and infrastructure.
  - b) Vibration during construction is minimised or eliminated to ensure no adverse impact on surrounding properties and infrastructure.
  - c) The risk of damage to adjacent existing property and infrastructure by the new development will be reduced to a level no greater than that from an event with an “unlikely” likelihood of occurrence and “minor” consequence.

Note: “adverse impact” means any damage caused to the improvements on adjoining properties by the demolition, excavation or construction on the development site.

## Controls

### ***General controls that apply to the entire LGA.***

- C1 Unless site specific information exists to the contrary, excavations deeper than 1m are assumed to have a potential impact on groundwater.

Note: Where the groundwater level is high, any proposed development with below-ground structures must consider the sub-surface conditions and the impacts of construction on surrounding properties.

Below-ground structures which are likely to extend below the level of seasonal fluctuations in the groundwater table, must also consider the impact of any changes induced in the sub-surface water levels and the groundwater flow patterns on surrounding properties.

## Requirements

- C2 All below-ground structures are fully tanked. These type of structures must not collect and dispose of subsoil/seepage to kerb and gutter.
- C3 Groundwater does not discharged to Council’s stormwater network, including stormwater pipes, pits and/or kerb and gutter.

**Notes:**

All below-ground works must also comply with the requirements of the NSW Department of Primary Industries Office of Water.

The design statement must confirm that the design of the below-ground structure has been undertaken in accordance with the relevant Australian Standards where applicable.

C4 Development applications which include below ground structures must include the following documents:

- a) Structural report
- b) Geotechnical and hydrogeological reports
- c) Design statement and supporting drawings that show the design measures proposed to minimise risks and to ensure that no adverse impacts will occur.

Note: Council may identify other circumstances where these reports are required. All reports must be prepared in accordance with Council's guidelines. Council may also require the preparation and submission of a pre-commencement dilapidation report for properties neighbouring the development.

C5 A qualified and experienced geotechnical and/or hydrogeological engineer must prepare the reports.

The reports must include a site-specific risk assessment matrix with appropriate definitions for qualitative measures of likelihood and consequences for assessing the risk of damage to existing developments by the new development.

C6 Where groundwater is present and dewatering is likely to occur on the site, the requirements of Council's DA Guide under the 'Investigations' section must be implemented.

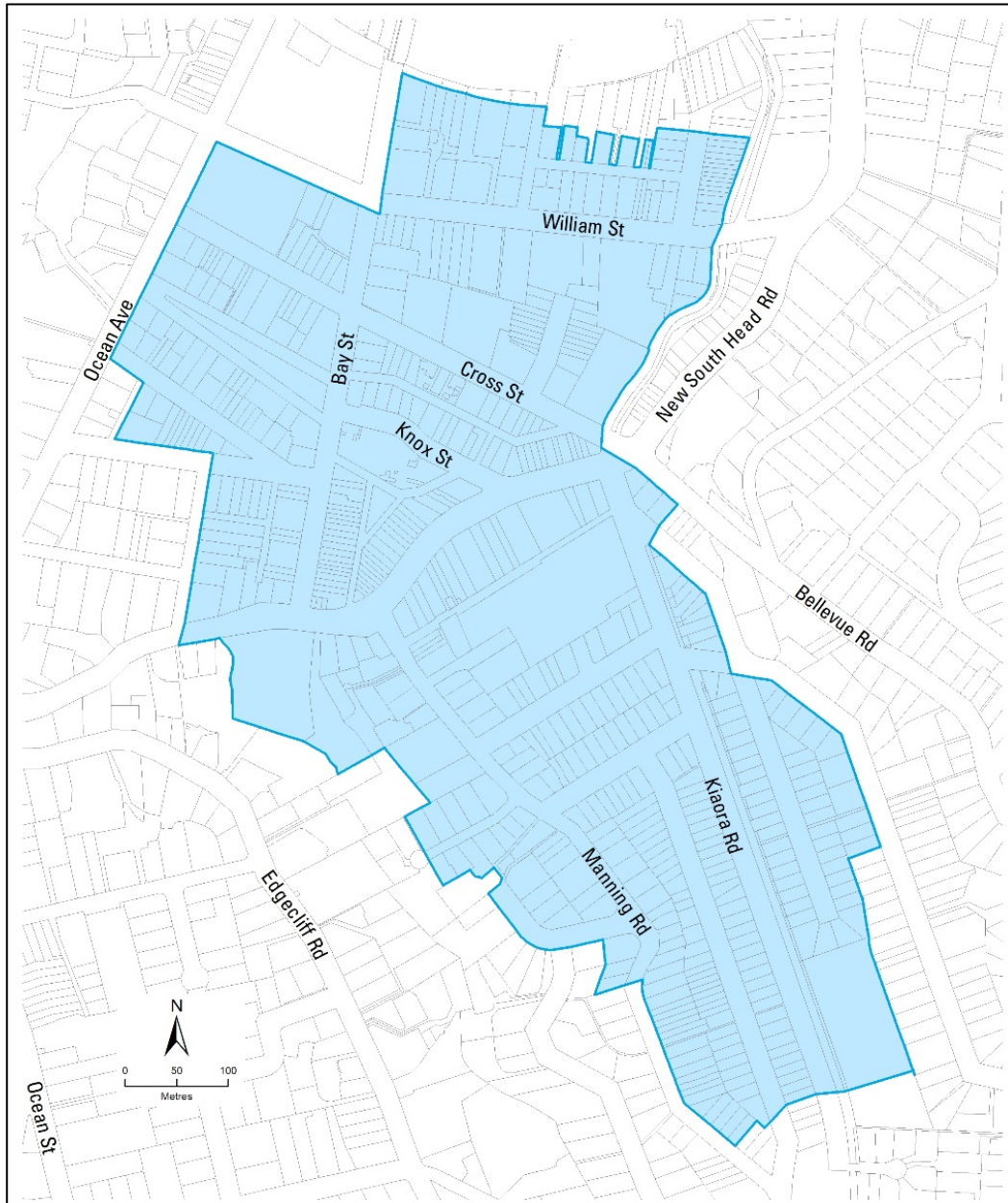
C7 Any geotechnical and hydrogeological reports must contain an Implementation Plan, including a Monitoring Program, Contingency Plan and Construction Methodology.

Note: All reports and requirements must be prepared in accordance with Council's DA Guide. Geotechnical reports must be prepared by an appropriately qualified Geotechnical Engineer who is NER registered with a minimum of 10 years practice in the geotechnical field in the last 15 years.

**Land in the Double Bay settlement area**

In addition to the general controls in this section, the following applies to the land in the Double Bay settlement area, as shown below.

**FIGURE 1 Double Bay settlement area**



- C8 Temporary changes to the groundwater level, due to construction, must not exceed 0.2 m from the average monitored pre-construction groundwater level unless calculations using the results of specific field testing, support a greater change and demonstrate that the change will not induce settlement greater than the characteristic surface movement of a Class S site as defined in Table 2.3 of Australian Standard AS2870-2011.

---

## E2.2.11 Absorption systems

---

### Objectives

- O1 To ensure development is designed, constructed and maintained so as to minimise impacts on the natural water cycle.
- O2 To reduce peak stormwater flows and total stormwater runoff volume.
- O3 To reduce the flood risk in urban areas.
- O4 To minimise stormwater impacts on downstream properties.

### Controls

#### *Where this applies*

- C1 Absorption systems may only be utilised where it is not possible to discharge drainage to Council's stormwater system by gravity.
- C2 Absorption systems will not be considered if easements, inter-allotment drains or drainage reserves are available to provide gravity feed access to Council's stormwater system.

#### *Requirements*

- C3 Absorption systems are designed to adequately contain the difference between inflow and outflow rates, depending on the permeability of the soil.
- C4 Generally the minimum soil depth to rock is 1.5m. However, in harbourside locations, a lesser value may be accepted. This will be assessed on the merits of the application.
- C5 Properties seeking to install an absorption system also install a rainwater tank in accordance with Section 2.2.2. The rainwater tank is at least 6m<sup>3</sup> per 100m<sup>2</sup> of impervious area across the site. The purpose of the rainwater tank is to reduce the quantity of water going to the absorption system.
- C6 The design addresses the impact of increased subsoil flow on properties downstream of the absorption trench, and details of the impact of the absorption pit on the downstream catchment are submitted.
- C7 Approval will not be provided where the nominal absorption rate is less than 0.1 litres/m<sup>2</sup>/s strata of impermeable or low permeability material are present, or where the water table is less than 2m from the base of the pit.

Notes: Applications for an absorption system must be accompanied by a concept plan showing the location, dimensions and levels of the proposed system. Applications for absorption systems must be prepared by a suitably qualified practitioner and comply with Council's Guide for preparing Geotechnical and Hydrogeological Reports.

Applications for an absorption system must be accompanied by a Geotechnical Report to accurately determine the following soil characteristics: the soil type/s to a depth of at least 2m, the nominal absorption rate, the depth to an identification of any strata through the soil and the depth of the water table. The soil characteristics must be determined using appropriate field tests.

---

## E2.2.12 Pump and sump systems

---

### Objectives

- O1 To mitigate the impacts of pumping water to areas that would normally not receive discharge.
- O2 To avoid the flooding of properties.
- O3 To protect existing Council drainage assets.

### Controls

#### *Where this applies*

- C1 Pump and sump systems will only be considered where the development involves alterations and additions to a dwelling house, and where the development increases the impervious area of the site by less than 40m<sup>2</sup>.
- C2 The pump and sump system may only be utilised for the development additions. That is, a pump and sump system may not be retrofitted to the component or sections of the building which are existing.

#### *Requirements*

- C3 The collection system for the pump and sump arrangement is designed in accordance with the design criteria for gravity drainage in this chapter.
- C4 The pump and sump system are designed by a suitably qualified practitioner and designed and installed in accordance with the appropriate industry standards.
- C5 Properties seeking to install a pump and sump system also install a rainwater tank in accordance with Section E2.2.2. The rainwater tank is at least 6m<sup>3</sup> per 100m<sup>2</sup> of impervious area across the site. The purpose of the rainwater tank is to reduce the quantity of water going to the pump and sump system.
- C6 The tank has an automatic pump which meets the following requirements:
  - a) The pump may only commence pumping a minimum of 1 hour after rain has ceased.
  - b) The pump may only operate when the rainwater tank is over 50% full.
  - c) The pump may only pump out the top 50% of the rainwater tank (the remaining water is to be available for reuse).
  - d) At a minimum, the pump out system must consist of dual alternating pumps and be connected to an uninterrupted power supply.
- C7 Discharge from the site does not exceed the permissible site discharge as outlined in Section 2.2.4 control C3.
- C8 In the event of the failure of both pumps, an overland flow path and/or surcharge and pondage area is identified and provided.



- C9 Discharge from the system passes through a stilling pit, located within the site boundary. Discharge to Council's underground stormwater system is via a concrete pipe with a minimum diameter of 375mm and a new stormwater junction pit located in the public road.
- C10 The pump and sump system is protected from backflow from Council's drainage system.
- C11 All electrical fittings and supply are 500mm above the maximum water level and/or any overland flow paths.

***Location***

- C12 Pressured pipes are only permitted on the applicant's property. Council will not approve the use of pressurised pipe systems within the road reserve or Council owned property.

Note: Industry standards include AS3500 National Plumbing and Drainage Code, other relevant codes and the manufacturer's specifications.

A positive covenant will be required for the maintenance of the pump and sump system.

---

### E2.2.13 Charged or siphonic systems

---

#### Objectives

- O1 To protect existing Council drainage assets.

#### Controls

##### *Where this applies*

- C1 Non-mechanical pressurised (charged or siphonic) systems will only be considered where it is not possible to discharge drainage to Council's stormwater system by gravity.

#### Requirements

- C2 The charged or siphonic system is designed by a suitably qualified practitioner and designed and installed in accordance with the appropriate industry standards.
- C3 In general, the discharge from charged or siphonic systems are connected to Council's below ground drainage system.
- C4 Only dwelling houses and developments involving alterations and additions, where the additional gross impervious area is less than 40<sup>m<sup>2</sup></sup>, may discharge from the charged or siphonic systems to the kerb and gutter.
- C5 Discharge from the system passes through a stilling pit, located within the site boundary.
- C6 The system is protected from backflow from Council's drainage system.  
Note: Industry standards include AS3500 National Plumbing and Drainage Code, other relevant codes and the manufacturer's specifications.

---

### E2.2.14 Activities on a public road

---

#### Objective

- O1 To protect Council's road assets.
- O2 To ensure works carried out on Council's road and stormwater assets meet Council's required standard.

#### Controls

- C1 All works, including stormwater works, within a public roadway are in accordance with Council's "Specification for Road Works, Drainage and Miscellaneous Works".
- Note: Where works, including stormwater works, are within a public roadway (including the footpath and nature strip areas), approval is subject to a separate application under Section 138 of the *Roads Act 1993*. The nominated principal certifying authority cannot legally give approval for works under Section 138 of the *Roads Act*. Approval must be granted by Council.

---

## E2.3 Flood risk management controls

### E2.3.1 Introduction

---

In assessing development applications for flood risk management within “flood risk precincts”, Council will consider each of the matters listed below and each matter must be addressed by the applicant. The response to these matters, plus any other relevant statutory and policy matters, will be considered by Council when assessing the acceptability of the development.

For each matter, specific objectives are given together with the controls to achieve those objectives. Alternative ways to achieve the stated objectives, will be considered when, in the opinion of Council, the outcome is better in terms of the impact on the public domain or adjacent properties than strict compliance with the stated controls.

The flood risk planning controls reflect the recommendations of the Woollahra Coastal Zone Management Plan, and the Floodplain Risk Management Plans for Double Bay, Rose Bay and Rushcutters Bay and the Updated Flood Study for Watsons Bay, prepared in accordance with the State Government Flood Prone Lands Policy and the Floodplain Development Manual.

### E2.3.2 Information available from Council

---

Council will make available information on flooding, coastal inundation and the Council drainage system, where it is available, on the express understanding that Council is not liable for the accuracy of the information or the consequences of it being used.

There are four main floodplains within the Woollahra Municipality:

- ▶ Rushcutters Bay
- ▶ Double Bay
- ▶ Rose Bay
- ▶ Watsons Bay.

Each of the floodplains can be classified based on different levels of potential flood risk. Flood information, including flood levels as derived from significant historical flood events, is available on each of these floodplain areas. This information may be found on Council’s website.

A Woollahra Coastal Zone Management Plan Stage 1 report has been prepared for the Woollahra Municipality. Estuary Planning Levels have been developed for those properties subject to coastal inundation.

The applicant must confirm the accuracy of information by inspection, survey and/or study. Where existing flood or coastal inundation information is not available but flooding and/or coastal inundation is considered by Council to be a potential issue, a site specific study may be required.

---

### E2.3.3 Flood planning levels

---

Flood planning levels (FPLs) set the floor level height for development in areas which are subject to flooding. The FPLs vary depending on the relative flood risk and the proposed development type.

FPLs consist of the following:

- ▶ a flood level which has been determined from a flood study (see Section E2.3.2); plus
- ▶ a freeboard that compensates for uncertainties in the estimation of flood levels across the floodplain.

#### Foreshore developments subject to coastal inundation

Foreshore developments subject to coastal inundation must give consideration to two factors:

- ▶ flood planning levels (FPLs); and
- ▶ estuary planning levels (EPLs).

EPLs consist of the following:

- ▶ a still water level which has been determined from a coastal inundation study (see Section E2.3.2); plus
- ▶ a local wind and wave setup height which has been determined from a coastal inundation study (see Section E2.3.2); plus
- ▶ a wave run-up/overtopping height which has been determined from a coastal inundation study (see Section E2.3.2); plus
- ▶ a sea level rise factor; plus
- ▶ a freeboard that compensates for uncertainties in the estimation of coastal inundation levels across the coastal zone.

Note: The NSW Chief Scientist has advised that the sea level rise benchmarks (measured as an increase above 1990 mean sea levels) of 40cm by 2050 and 90cm by 2100 are adequate in light of evolving understanding of the complex issues surrounding future sea levels.

All EPLs should be based on the 2100 benchmark.

#### Objectives

- O1 To minimise risk to people and property.
- O2 To reduce the long term risks associated with coastal inundation, elevated sea levels and/or waves overtopping foreshore defences.
- O3 To maintain Council's streetscape objectives in existing commercial and heritage areas.

## Controls

- C1 All new developments and major alterations and additions have their floor levels set at the required FPL and EPL as stipulated in the following table:

Development type	Flood (and estuary) planning level
Habitable floor areas	100 Year ARI flood level plus 0.5m freeboard
Non-habitable floor areas	100 Year ARI flood level plus 0.3m freeboard
Habitable floor areas for foreshore developments subject to coastal inundation	The highest RL, calculated from the following: <ul style="list-style-type: none"> <li>▶ 100 Year ARI flood level plus 0.5m freeboard; or</li> <li>▶ still water level plus 100 Year ARI wave run-up plus 0.3m freeboard</li> </ul>
Ground level, open car parking spaces	20 Year ARI flood level plus 0.3m freeboard
Enclosed car parking spaces, three or fewer vehicles	20 Year ARI flood level plus 0.3m freeboard
Enclosed car parking spaces, more than three vehicles	100 Year ARI flood level plus 0.3m freeboard

- C2 For alterations and/or additions (only) developments, where it is not practical to meet the above habitable, non-habitable and car parking floor levels due to compatibility with the height of adjacent buildings, or compatibility with the floor level of existing buildings, a lower floor level may be considered, based on the individual merits.

A lower floor level will only be permitted where the habitable floor area increases by 40m<sup>2</sup> or less. In these circumstances, the floor level is to be as high as practical, and no lower than the existing floor level. This concession will be made no more than once for any given property. Subsequent development applications will be required to meet the FPLs and EPLs as outlined in C1.

- C3 To achieve the required FPL and/or EPL for car parking, Council may allow the use of mechanical barriers such as flood gates. Where a mechanical barrier is permitted:
- a) a 0.5m freeboard is provided
  - b) the mechanical barrier is located wholly on private property
  - c) the mechanical barrier may require the provision of an on-site queuing area (see Chapter E1 Parking and Access for further details)
  - d) the mechanical barrier is designed such that, by default, it is in the “closed” position. That is, it opens only to allow vehicles to enter and exit the site.

Note: The mechanical barrier must be designed and installed by a suitably qualified practitioner. A positive covenant will be required for maintenance of the mechanical barrier.

- 
- C4 Filling of the site, where acceptable to Council, may change the flood and/or coastal inundation risk for the subject land. The FPL and/or EPL controls is based on the new flood and/or coastal inundation risk as determined by the new site levels.

#### Special consideration

- C5 All FPLs and EPLs represent the minimum standard required for the development type. An applicant may seek to lower the minimum FPL and/or EPL. Such requests will be assessed on their merits. A Flood Risk Management Report and/or a Coastal Inundation Assessment, prepared by a suitably qualified practitioner, will be required.

Note:

A Flood Risk Management Report and/or Coastal Inundation Assessment must be prepared by a suitably qualified practitioner and at a minimum it should include the following:

- ▶ acknowledgement that the proposed development seeks to lower the minimum standard FPL and/or EPL required by Council's Stormwater Drainage and Flood Risk Management Development Control Plan;
- ▶ proposed risk management measures to minimise the impact of flooding and/or coastal inundation;
- ▶ demonstration that the risk management measures will not adversely affect other properties;
- ▶ an Emergency Management Plan that includes an evacuation strategy.

- C6 For ground level shop fronts in commercial and mixed-use developments, a lower the FPL and/or EPL may be considered to allow the development to match into existing longitudinal street levels, to optimise retail potential and/or to provide acceptable access for persons with disabilities. Such requests will be assessed on their merits. Driveway and footpath gradients must comply with Council's specifications.
- C7 For heritage conservation properties, a lower FPL and/or EPL may be considered, for the heritage component of the building only, to remain sympathetic with the heritage values of the property. In general, any alterations and additions will be required to meet the FPL and/or EPL as outlined in conditions C1, C2, C3 and C4. Such requests will be assessed on their merits.

---

## E2.3.4 Flood controls

---

### Objectives

- O1 To minimise risk to people and property.
- O2 To ensure that development does not cause flood levels to rise or exacerbate flooding on the surrounding floodplain.
- O3 To ensure existing overland flow paths are maintained and to ensure new structures do not obstruct the free flow of floodwaters.
- O4 To increase flood hazard awareness.
- O5 To reduce the long term risks associated with tidal inundation, elevated sea levels and/or waves overtopping foreshore defences.
- O6 To maintain Council's streetscape objectives in existing commercial and heritage areas.

### Controls

#### *General controls which apply to all developments*

Note: A plan must accompany the application and provide information on any earthworks or filling of land (with suitable contour intervals) and the location of existing and proposed fences, retaining walls and/or any other barriers.

#### *General*

- C1 All structures have flood compatible building components below the 100 Year ARI level plus 0.5m freeboard.
- C2 All electrical equipment (e.g. air conditioners and pool pumps) is located or protected to above the 100 Year ARI level plus 0.5m freeboard.
- C3 All storage areas such as shelving are above the 100 Year ARI level plus 0.5m freeboard.
- C4 The structure is built to withstand the forces of floodwater, debris and buoyancy up to and including the 100 Year ARI level plus 0.5m freeboard.
- C5 Reliable evacuation access for pedestrians is provided from the lowest habitable floor area to a refuge area above the PMF level and designed to withstand PMF water forces.
- C6 Suitable flood protection (e.g. a crest up before descent on an access driveway) is provided within the subject site. Council will not generally allow alteration to existing levels on the public road or its property to achieve flood protection.

Note: The Building Code of Australia 2013 has requirements relating to minimum construction standards for specified building classifications in flood hazard areas. Reference should be made to the Code for further information.

### *Fencing*

- C7 Fencing is constructed in a manner which does not change the nature or level of flood waters in the area. Fencing is of a permeable/open type design, however, existing solid fences may be replaced by new solid fences.
- C8 Fencing is adequately constructed so as to withstand the forces of floodwaters.
- C9 The flood impact of the development is considered to ensure that the development will not increase flood effects elsewhere. Where a significant change in use of the site is proposed, a flood impact assessment is required.

### *Overland flow paths*

- C10 All overland flow paths are free of structures which prevent the free passage of overland flow.
- C11 All overland flow paths are designed to convey the 1 in 100 ARI event.
- C12 All existing overland flow paths are maintained and the hydraulic capacity of the openings between buildings is maintained.
- C13 Overland flow paths are provided on all properties that have upstream contributing catchments of 1,000m<sup>2</sup> or greater.
- C14 All overland flow paths are designed to a low hazard classification if possible.
- C15 Overland flow paths are designed such that they do not increase velocity or concentrate water on any adjacent property.
- C16 In overland flow paths, fencing is generally not be permissible. However, in low and medium flood risk precincts permeable/open type fences may be approved where it can be demonstrated that there will be no adverse impact on flooding to the subject land or surrounding properties.
- C17 Any structure located in an overland flow path is designed to be structurally sound in all flood events. A flood study may be required. Structures are designed by a suitably qualified practitioner.
- C18 If an overland flow path is not achievable, a 1 in100 ARI drainage system may be accepted as an alternative.
- C19 Overland flow paths are grass turfed.
- C20 In (sandy) areas with high risk erosion potential, overland flow paths are designed to limit velocity and/or protect against scour.

Note: Provisional hazard classifications are defined in Appendix L of the Floodplain Development Manual.



*Time limit consents*

C21 Where an applicant cannot increase EPLs to take into account the sea level rise planning benchmarks, Council may consider imposing time-limited consent to provide the potential to remove, replace or adapt development in the future. The consent will require the development to cease and all structures to be demolished and removed and the site to be reinstated to a sustainable landscaped form unless a further consent is obtained allowing for the continuation of the development in its originally approved or modified form. Council will consider the appropriateness of such developments on the merits of individual applications.

Note: It is likely that Council would impose a condition which identifies an appropriate and specific trigger which would require the removal of the development. For example, if the sea level were to reach a specified height or the erosion of an escarpment receding to a specified distance from the property boundary.

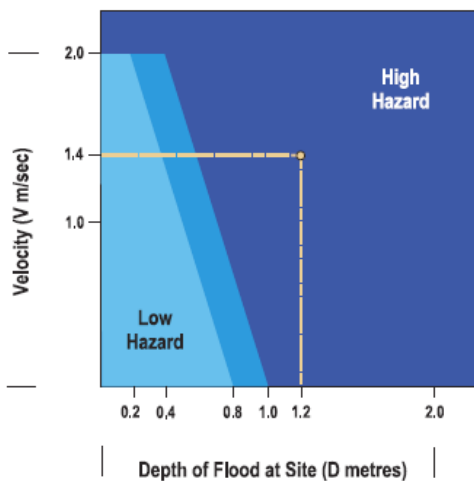
**High flood risk precincts**

Note: The high flood risk precinct is where high flood damages, potential risk to life and/or evacuation problems would be anticipated or where development would significantly or adversely alter flood behaviour. Development in this precinct requires detailed risk management strategies and careful design to reduce the risk to life and property to an acceptable level.

The High FRP would generally be reflected by the following criteria:

- all areas where high hazard conditions occur during a 100 year ARI flood (using the provisional hazard categories published in Appendix L of the Floodplain Development Manual);
- all locations where safe evacuation routes cannot be provided by the natural topography, necessitating the need for refuge areas to be provided; and
- all floodways.

**FIGURE 2** Provisional hydraulic hazard categories  
Source: Floodplain Development Manual



**Notes:**

The degree of hazard may be either:

- Reduced by establishment of an effective flood evacuation procedure;
- Increased if evacuation difficulties exist.

In the transition zone highlight by the median colour, the degree of hazard is dependant on site conditions and the nature of the proposed development.

**Example:**

If the depth of flood water is **1.2m** and the velocity of floodwater is **1.4m/sec** then the provisional hazard is **high**.

C22 Properties within a high flood risk precinct are unsuitable for all development (except alterations and additions (only) developments) unless a Flood Risk Management Report has been prepared, by a suitably qualified practitioner, outlining appropriate risk management measures.

C23 Buildings or structures constructed in high flood risk precincts are designed to withstand the PMF event.

C24 No new fencing of any type is permitted in high flood risk precincts unless it can be demonstrated, by a suitably qualified practitioner, that there will be no adverse impact on flooding to the subject land or surrounding properties.

***Medium flood risk precincts***

Note: The medium risk precinct includes all land that is inundated by the 100 year ARI flood that is not classified as high risk. Areas on the edge of the identified 100 year ARI floodplain where the topography provides low hazard rated excavation routes (using the provisional hazard criteria published in Appendix L of the Floodplain Development Manual) would generally be classified as medium risk.

- C25 Properties within a medium flood risk precinct are generally unsuitable for critical and sensitive use development. Such developments will be considered on their merits, taking into account any proposed risk management measures.
- C26 In medium flood risk precincts, impervious and continuous fencing is not permissible unless it can be demonstrated that there will be no adverse impact on flooding to the subject land or surrounding land.

***Low flood risk precincts***

Note: In the low flood risk precinct the likelihood of damages, occurring from flooding, is low. This area can be identified as land within the floodplain that is above the 100 year ARI flood but below the extent of the PMF.

- C27 For critical and sensitive developments in low flood risk precincts, all habitable and non-habitable floor levels are no lower than the PMF flood level.
- C28 For critical and sensitive developments in low flood risk precincts, all structures have flood compatible building components below the PMF flood level.
- C29 For critical and sensitive developments in low flood risk precincts, the applicant is to demonstrate that any structure can withstand the forces of floodwater, debris and buoyancy up to and including the PMF flood level.

---

***Other flood prone properties***

Note: There are four main floodplains within the Woollahra Municipality: Rushcutters Bay, Double Bay, Rose Bay and Watsons Bay. A property may be flood prone if it is outside of the identified four floodplains, but subject to overland flows due to one of the following characteristics:

- ▶ the property is on the low side of the road and/ or the boundary levels are below the level of Council's kerb;
- ▶ the property is lower than surrounding properties;
- ▶ the property is in a natural low point, gully or depression; or
- ▶ the property is adjacent to or contains a flow path, open channel, watercourse or drainage line.

A property may also be flood prone if it is outside of the identified four floodplains, but subject to one of the following characteristics:

- ▶ the property fronts Sydney Harbour with any part of the land below RL 3.35m AHD;
- ▶ the development includes underground habitable areas; or
- ▶ the development includes a low level driveway or an underground car park.

C30 Where a property is outside of the four flood plains, but identified as flood prone, a site specific assessment is required. A flood analysis may be requested to determine the level of flood risk and to allow the setting of FPLs.

Note: A Flood Risk Management Report prepared, by a suitably qualified practitioner, outlining appropriate risk management measures may be required.

## Appendix 1 – Definitions

The definitions in this appendix define words and expressions for the purpose of this chapter.

Other terms may be defined in other parts of the DCP, the Woollahra LEP 2014, and other publications including the NSW Government’s Floodplain Management Manual: The Management of Flood Liable Land.

<b>absorption system</b>	an excavation that has been filled with material or prefabricated void units that are conducive to the drainage of stormwater and which are designed to drain vertically or side-ways, into adjacent sub-surface in-situ void or fill material.
<b>alterations and additions (only) developments</b>	<p>applies to the following developments:</p> <ul style="list-style-type: none"> <li>▶ residential development where the proposed development is an addition and/or alteration to an existing dwelling of not more than 40m<sup>2</sup> or 10% (whichever is the lesser) of the habitable floor area which existed at the date of commencement of this DCP;</li> <li>▶ development other than residential where the proposed development is an addition to existing buildings of not more than additional 100m<sup>2</sup> or 10% (whichever is the lesser) of the floor area which existed at the date of commencement of this DCP (whichever is the lesser).</li> </ul>
<b>charged or siphonic systems</b>	use the height of the building to create a pressurised stormwater system. This allows the system to draw water out of the gutters at higher velocities and flow rates. The drainage line permanently holds water.
<b>coastal inundation</b>	is the storm-related flooding of coastal lands by ocean waters due to elevated still water levels (storm surge) and wave run-up.
<b>commercial and mixed-use development</b>	applies to all properties zoned Neighbourhood Centre, Local Centre, Mixed Use in Woollahra LEP 2014.

**critical and sensitive developments**

applies to the following types of developments: Emergency services facilities; public administration building that may provide an important contribution to the notification or evacuation of the community during flood events (e.g. SES Headquarters and Police Stations); hospitals; community facility; telecommunications facility; institutions; educational establishments; child care facilities; liquid fuel depot; public utility undertaking (including electricity generating works; sewerage treatment plant; sewerage system; telecommunications facility; utility installations and water treatment facility) which are essential to evacuation during periods of flood or if affected would unreasonably affect the ability of the community to return to normal activities after flood events; residential care facility; school and seniors housing.

**developments creating high levels of pollutants**

may include, but is not limited to the following: service stations; motor repair shops; panel beaters; miscellaneous automotive; marinas; boatsheds; marine repairs; shipbuilders; commercial slipways; miscellaneous retailers and manufacturers involving chemicals, solvents, hazardous waste and containers; miscellaneous retailers and manufacturers involving garden and building materials; vehicle depots; and car parks.

**enclosed car parking**

car parking which is potentially subject to rapid inundation, which consequently increases danger to human life and property damage (such as basement of bunded car parking areas). The following criteria apply for the purposes of determining what is enclosed car parking:

- flooding of surrounding areas may raise water levels above the perimeter which encloses the car park (normally the entrance), resulting in rapid inundation of the car park to depths greater than 0.8m, and
- drainage of accumulated water in the car park has an outflow discharge capacity significantly less than the potential inflow capacity.

**Epoch**

for determining design flood levels refers to a year in the future for which flood level probabilities are calculated. For example, the notation 100 Year ARI 2050 refers to the 100 year ARI flood level (or 1% AEP flood level) at the Year 2050 Epoch. This is a prediction made now (based on the best available information) of the flood level which has a 1% probability of occurring or being exceeded in 2050. Similarly, the Year 2100 Epoch refers to the flood level which has a 1% probability of occurring or being exceeded in 2100.

**flood evacuation strategy**

the proposed strategy for the evacuation of flood prone areas.

---

<b>flood risk precincts (FRPs)</b>	are a categorisation of a site's flood risk for land-use planning purposes. All property within a floodplain falls into one of three classifications: low, medium or high.
<b>foreshore developments</b>	includes all properties with any part of their land below RL 3.35m AHD.
<b>foreshore inundation</b>	the inundation of land occurring when water from Sydney Harbour overflows the natural or human-made foreshore boundary. All properties with any part of their land below RL 3.35m AHD may be impacted by foreshore inundation.
<b>freeboard</b>	a factor of safety typically used in relation to the setting of flood planning levels. It compensates for uncertainties in the estimation of flood levels across the floodplain, such as wave action, localised hydraulic behaviour and impacts that are specific event related, such as levee and embankment settlement, and other effects such as sea level rise.
<b>green roofs</b>	a roof system, with a dual function. It designed to promote the growth of various forms of vegetation on the top of buildings. It is also designed to support various forms of renewable energy and water collection technology to assist in supplying power and water to the occupants of the building.
<b>habitable floor area</b>	as defined in the Floodplain Development Manual: The Management of Flood Liable Land.
<b>local overland flooding</b>	as defined in the Floodplain Development Manual: The Management of Flood Liable Land.  Note: All properties containing a Council owned pipe and/ or a drainage easement are subject to local overland flooding. All properties with low level driveways, footpaths or where their boundary levels are below the level of Council's kerb are subject to local overland flooding.
<b>low level property</b>	any property where the property falls away from the road reserve. That is, the grade or level of the land generally falls from the front to rear boundary. Stormwater from the property generally falls towards a neighbour's property at the side or rear (rather than to Council's road).

---

<b>mainstream flooding</b>	<p>as defined in the Floodplain Development Manual: The Management of Flood Liable Land.</p> <p>Note: Properties that are situated adjacent to an open or covered channel or watercourse may be impacted by mainstream flooding.</p>
<b>major alterations and additions</b>	<p>applies to the following developments:</p> <ul style="list-style-type: none"> <li>► residential development where the proposed development is an addition and/or alteration to an existing dwelling of more than an additional 40m<sup>2</sup> or 10% (whichever is the lesser) of the habitable floor area which existed at the date of commencement of this DCP;</li> <li>► development other than residential where the proposed development is an addition to existing buildings of more than an additional 100m<sup>2</sup> or 10% (whichever is the lesser) of the floor area which existed at the date of commencement of this DCP (whichever is the lesser).</li> </ul>
<b>on-site detention systems</b>	<p>holding ponds that temporarily store stormwater to control and reduce downstream flow rates. They are designed to retard stormwater during intense rainfall and to empty once the peak of the storm has passed.</p>
<b>overland flow paths</b>	<p>above ground drainage paths that form a critical part of the drainage system. They convey stormwater when the stormwater volume is greater than the designed pipe systems capacity.</p>
<b>pervious surface</b>	<p>a paving system that allows water to infiltrate through pores in the pavement and is stored in voids until it can percolate through the natural ground. Pervious surfaces include, but are not limited to, porous asphalt, porous concrete and modular pavers.</p>
<b>pump and sump systems</b>	<p>a pump that is used to remove water that has accumulated in a sump basin, often in underground areas such as car parks. The sump pump is used to send water away from the house.</p>
<b>rain garden</b>	<p>a planted depression that captures rainwater runoff from impervious urban areas such as car parks. The rain garden serves two main purposes. It reduces stormwater runoff through absorption into the ground and transpiration. Secondly, the plants grown within the rain gardens capture pollutants and reduce the amount of pollution which is then released to Council’s stormwater system.</p>
<b>refuge area</b>	<p>an area of land located above the PMF that provides reasonable shelter for the likely occupants of the development commensurate with the period of time that refuge is likely to be required in floods up to the PMF.</p>



<b>residential development</b>	applies to all properties zoned Low Density Residential and Medium Density Residential in Woollahra LEP 2014.
<b>site emergency response flood plan</b>	a management plan that demonstrates the ability to safely evacuate persons and includes a strategy to move goods above the flood level within the available warning time. This Plan must be consistent with any relevant flood evacuation strategy, flood plan or similar plan.
<b>stormwater</b>	untreated rain water that runs off the land onto which it falls.
<b>suitably qualified practitioner</b>	a professional with the appropriate qualifications, experience and skills to undertake the task. All suitably qualified practitioners should have appropriate professional indemnity insurance.
<b>wave run-up and overtopping</b>	the process where a wave reaches the foreshore, and an “uprush” of water onto the foreshore will occur. The height of wave run-up is affected by the nature of the foreshore. In some instances a wave may propagate over the foreshore edge and further landward, which is called wave overtopping. Wave run-up cannot occur up a vertical seawall and in these cases the hazard is related exclusively to wave overtopping.

## Appendix 2 – Design rainfall intensities

The following design rainfall intensities are to be used throughout the municipality.

### Woollahra Council design rainfall intensities

Duration		Average recurrence interval						
		1 in 1	1 in 2	1 in 5	1 in 10	1 in 20	1 in 50	1 in 100
Minutes	Hours	Rainfall intensities in mm/hour						
5	0.083	104	133	167	187	213	246	271
6	0.100	98	125	157	175	199	231	254
7	0.117	92	118	148	166	189	219	241
8	0.133	88	112	141	158	180	209	231
9	0.150	84	107	135	151	173	201	222
10	0.167	80	102	130	146	166	193	214
11	0.183	77	99	125	140	161	187	207
12	0.200	74	95	121	136	156	181	201
13	0.217	72	92	117	132	151	176	195
14	0.233	69	89	114	128	147	171	190
15	0.250	67	86	111	124	143	167	185
16	0.267	65	84	108	121	139	162	180
17	0.283	64	82	105	118	136	159	176
18	0.300	62	80	102	115	133	155	172
19	0.317	60	78	100	113	130	152	168
20	0.333	59	76	98	110	127	148	165
21	0.350	57	74	95	108	124	145	162
22	0.367	56	72	93	106	122	143	159
23	0.383	55	71	91	104	119	140	156
24	0.400	54	69	90	101	117	137	153
25	0.417	53	68	88	100	115	135	150
26	0.433	52	67	86	98	113	132	147
27	0.450	51	65	85	96	111	130	145
28	0.467	50	64	83	94	109	128	143
29	0.483	49	63	82	93	107	126	140
30	0.500	48	62	80	91	105	124	138
31	0.517	47	61	79	90	104	122	136
32	0.533	46	60	78	88	102	120	134

Duration		Average recurrence interval						
		1 in 1	1 in 2	1 in 5	1 in 10	1 in 20	1 in 50	1 in 100
Minutes	Hours	Rainfall intensities in mm/hour						
33	0.550	46	59	77	87	101	118	132
34	0.567	45	58	75	86	99	117	130
35	0.583	44	57	74	84	98	115	128
36	0.600	43	56	73	83	96	113	126
37	0.617	43	55	72	82	95	112	125
38	0.633	42	55	71	81	94	110	123
39	0.650	42	54	70	80	92	109	121
40	0.667	41	53	69	79	91	107	120
41	0.683	40	52	68	78	90	106	118
42	0.700	40	52	67	77	89	105	117
43	0.717	39	51	67	76	88	103	115
44	0.733	39	50	66	75	87	102	114
45	0.750	38	50	65	74	86	101	113
46	0.767	38	49	64	73	85	100	111
47	0.783	37	48	63	72	84	99	110
48	0.800	37	48	63	71	83	97	109
49	0.817	37	47	62	70	82	96	108
50	0.833	36	47	61	70	81	95	106
51	0.850	36	46	60	69	80	94	105
52	0.867	35	46	60	68	79	93	104
53	0.883	35	45	59	67	78	92	103
54	0.900	35	45	59	67	77	91	102
55	0.917	34	44	58	66	77	90	101
56	0.933	34	44	57	65	76	89	100
57	0.950	33	43	57	65	75	89	99
58	0.967	33	43	56	64	74	88	98
59	0.983	33	42	56	63	74	87	97
60	1	32	42	55	63	73	86	96
90	1.5	25	33	43	49	57	67	75
120	2	21	27	36	41	47	56	63
180	3	16	21	27	31	36	43	48
240	4	13	17	22	26	30	35	39
300	5	11	15	19	22	26	30	34

Duration		Average recurrence interval						
Minutes	Hours	1 in 1	1 in 2	1 in 5	1 in 10	1 in 20	1 in 50	1 in 100
		Rainfall intensities in mm/hour						
360	6	10	13	17	19	23	27	30
720	12	6	8	11	12	14	17	19
1440	24	4	5	7	8	9	11	12
2880	48	3	3	4	5	6	7	8
4320	72	2	3	3	4	4	5	6

**Probable maximum precipitation depth in mm**

Duration		Catchment area		
Minutes	Hours	1km <sup>2</sup>	2km <sup>2</sup>	3km <sup>2</sup>
15	0.25	170	160	160
30	0.5	250	240	230
60	1	360	350	340
90	1.5	460	450	440
120	2	540	530	520
180	3	660	640	630
360	6	870	850	830

# Chapter E3 Tree Management

Part E ► General Controls for All Development

CHAPTER E3 APPROVED ON 27 APRIL 2015  
AND COMMENCED ON 23 MAY 2015

Last amended on 14 July 2023



# Chapter E3 ► Tree Management

## Contents

<b>E3.1</b>	<b>INTRODUCTION .....</b>	<b>1</b>
	E3.1.1 Land where this chapter applies .....	1
	E3.1.2 Development to which this chapter applies .....	1
	E3.1.3 Objectives .....	2
	E3.1.4 Relationship to other parts of the DCP .....	2
	E3.1.5 Relationship to other documents.....	2
<b>E3.2</b>	<b>TREES AND WORKS THAT REQUIRE APPROVAL .....</b>	<b>5</b>
	E3.2.1 Prescribed trees .....	5
	E3.2.2 Works that requires a development application.....	5
	E3.2.3 Works that requires a tree permit .....	6
<b>E3.3</b>	<b>ASSESSING A DEVELOPMENT APPLICATION OR A TREE PERMIT .....</b>	<b>7</b>
	E3.3.1 Matters to be considered—all applications .....	7
	E3.3.2 Additional matters to be considered—works requiring a DA.....	8
	E3.3.3 Matters that do not justify tree removal or pruning.....	8
<b>E3.4</b>	<b>EXEMPT TREES AND WORKS.....</b>	<b>9</b>
	E3.4.1 Exempt species .....	9
	E3.4.2 Exempt works .....	10





---

## E3.1 Introduction

The Woollahra Municipality is well known for its leafy character. This character is valued and identified by the extensive tree canopies that exist throughout the area, and many people are attracted to live in Woollahra as a result of these trees and landscapes.

Trees and vegetation play important roles in the preservation of wildlife habitat, the establishment of community identity and in the quality of streetscapes. Landscaped open space areas and vegetated deep soil contribute to the amenity of individual dwellings and are important in stormwater management and the energy efficiency of developments.

Our community recognises and values trees for their range of contributions including aesthetic environmental, ecological, social, psychological and economic wealth. Council's approach to tree management and this DCP reflects these values.

Development should seek to retain existing trees and vegetation, where possible.

This chapter has been prepared in accordance with Chapter 2 (Vegetation in Non-Rural Areas), of the State Environmental Planning Policy (Biodiversity and Conservation) 2021 (Biodiversity and Conservation SEPP) which outlines additional provisions relating to the protection and preservation of trees and vegetation.

Part 2.3 of the Biodiversity and Conservation SEPP identifies that Council, through a DCP, can require a permit or development consent for tree works (i.e. to prune or remove a tree) where the species, size, location or other criteria are prescribed in a DCP.

This chapter of the DCP establishes the list of prescribed trees, and works to those trees that require Council's approval. This chapter also identifies trees and works that do not require approval.

### E3.1.1 Land where this chapter applies

---

This chapter applies to all land within the Woollahra Municipality.

### E3.1.2 Development to which this chapter applies

---

This chapter applies to tree works proposed to be carried out on or near a prescribed tree. Tree works include pruning any tree part, removing, injuring or willfully destroying a tree, and the like.

If a tree is not identified in this chapter as a prescribed tree, approval for the tree works is not required. Section E3.4 of this chapter also identifies types of trees and works that do not require approval.

---

### E3.1.3 Objectives

---

The objectives of this chapter are:

- O1 To identify trees which are prescribed for the purpose of Part 2.3 of the Biodiversity and Conservation SEPP.
- O2 To define the different circumstances under which a development consent or permit application is required for works to a prescribed tree.
- O3 To promote, maintain and conserve the leafy character of the Woollahra Municipality.
- O4 To conserve significant trees of historic, cultural, commemorative, scientific, visual or aesthetic importance.
- O5 To sustain and enhance Woollahra's tree canopy cover whilst providing opportunities for development on private land.

### E3.1.4 Relationship to other parts of the DCP

---

This chapter is to be read in conjunction with the other parts of the DCP that are relevant to the development proposal, including:

- ▶ If located in a residential area—the controls in Part B: General Residential, or Part C: Heritage Conservation Areas that apply to the land.
- ▶ If located in a business centre—the controls in Part D: Business Centres that apply to the land.
- ▶ Part E: General Controls for All Development - this part contains chapters on Parking and Access, Stormwater and Flood Risk Management, Tree Management, Contaminated Land, Waste Management, Sustainability, Signage and Adaptable Housing.
- ▶ Part F: Land Use Specific Controls - this part contains chapters on Child Care Centres, Educational Establishments, Licensed Premises and Telecommunications.

### E3.1.5 Relationship to other documents

---

#### State Environmental Planning Policy (Exempt and Complying Development Codes) 2008

Under the Exempt and Complying Development Codes SEPP, a complying development certificate can be issued for the removal or pruning of a tree or other vegetation under the General Housing Code (Part 3) and the Commercial and Industrial (New Buildings and Additions) Code (Part 5A), subject to compliance with the specified development standards. Refer to the Codes SEPP for details.

#### Biodiversity Conservation Act 2016

The Biodiversity Conservation Act 2016 (Biodiversity Act) sets out the NSW Government's framework for biodiversity assessment and management in conjunction with the Local Land Services Act 2013 (as amended by the Local Land Services Amendment Act 2016 (LLSA)).

---

The Biodiversity and Conservation SEPP and Biodiversity Act require that clearing of native vegetation that:

- a) does not form part of a development assessment and
- b) that is above the Biodiversity Offset Scheme (BOS) threshold;

requires assessment and approval from the Native Vegetation Panel. The Native Vegetation Panel is constituted under the LLSA.

For clearing that is below the BOS threshold, the Biodiversity and Conservation SEPP enables councils to regulate clearing of vegetation as set out in the DCP.

Note: Due to the nature of the thresholds, it is unlikely that the BOS threshold will be exceeded in our LGA.

### **Register of Significant Trees (1991)**

The register establishes a list of trees located on private property and public land that are identified as significant to the surrounding area. The register is available on the Council website.

### **Tree Management Policy (2011)**

The Woollahra Tree Management Policy (TMP) covers public and private trees in the Municipality. The policy defines the key principles and processes Council uses for maintaining public and private tree collections in a safe, healthy and environmentally sensitive way.

The policy aims to improve the safety and wellbeing of the public, and of staff and contractors working on trees. It is also used as a reference by staff, Councillors, residents and tree workers who need to make or understand decisions about managing and maintaining public and private trees. The TMP also outlines the management principles and guidelines for matters such as road and pedestrian path clearances and view pruning. The TMP is available on the Council website.

### **Woollahra Street Tree Master Plan (2014)**

The Woollahra Street Tree Master Plan is a guide to aid in the maintenance and provision of street trees across the municipality. The objective of the Master Plan is to provide a sustainable and strategic framework that is used for the management of Woollahra's street tree canopy.

The Master Plan contributes to the collective urban forest for the benefit of all through good planning, maintenance, enhancement and reinforcing Council's ongoing commitment to the protection of trees. The Master Plan is available on the Council website.

### **Australian Standard AS 4373 Pruning of Amenity Trees**

This standard is used as a guide when assessing applications and defines uniform tree pruning procedures and practices in order to minimize the adverse or negative impact of pruning on trees.

### **Australian Standard 4970 Protection of trees on development sites**

This standard is used to provide guidance for the protection of trees in the planning and development processes.

---

### **Development Application (DA) Guide**

The DA Guide explains how to prepare a development application. In particular, it includes several detailed specifications on how to present arboricultural information.

The guide provides a step-by-step guide to all the things needed before submitting an application, and should be used as a checklist for completing plans and other supporting documentation. The DA Guide is available on the Council website.

## E3.2 Trees and works that require approval

A person must not undertake works to a prescribed tree without development consent or a permit granted by Council.

This section identifies what trees are “prescribed”, and sets out the approval mechanism that applies.

### E3.2.1 Prescribed trees

For the purpose of Part 2.3 of the Biodiversity and Conservation SEPP, the following vegetation is declared to be vegetation to which the Biodiversity and Conservation SEPP applies:

1. Any vegetation, whether of indigenous, endemic, exotic or introduced species with a diameter spread of branches greater than 3m or with a height greater than 5m, irrespective of the spread of branches, and that is not identified in this chapter as exempt.<sup>1</sup>
2. Any vegetation, whether of indigenous, endemic, exotic or introduced species with roots greater than 50mm diameter, but only if root pruning is proposed.
3. Any tree or palm identified in Council's Significant Tree Register.
4. Any tree or palm identified in Schedule 5 Environmental Heritage of Woollahra LEP, or located on land identified in Schedule 5 including:
  - c) a tree listed as a heritage item;
  - d) a tree located on land identified as containing a heritage item; or
  - e) a tree on land within a heritage conservation area.
5. Any bushland as defined in *State Environmental Planning Policy 19 - Bushland in Urban Areas*.

### E3.2.2 Works that requires a development application

A development application (DA) is required for the tree works if the tree is a type prescribed in Section 3.2.1 above, and any of the following apply:

1. the proposed works to the tree are part of an application for other building work or development that requires a DA;
2. the tree is identified in Council's Significant Tree Register and the tree works involve the removal of the tree; or
3. the tree is identified in Schedule 5 Environmental Heritage of Woollahra LEP 2014, or located on land identified in Schedule 5, and the tree works are not minor (i.e. may have an impact on heritage significance and amenity).

---

<sup>1</sup> Certain types of tree or works are exempt, for example, noxious weeds. Refer to Section E3.4 below for the list of exempt trees and works.

---

### E3.2.3 Works that requires a tree permit

---

A permit application is required for the tree works to a prescribed tree whenever development consent does not apply, as required in Section 3.2.2 above.

For example, a permit is required if:

1. the tree is identified on Council's Significant Tree Register and the proposed work is to prune the tree; or
2. the tree is located on land identified as a heritage item in Schedule 5 of Woollahra LEP 2014 and the proposed works are minor (e.g. will not have an impact on heritage significance or amenity).

### E3.3 Assessing a development application or a tree permit

This section identifies the matters that Council will consider when determining an application for works in or near prescribed trees.

These matters are to be addressed by the applicant when describing the proposed works.

Council may request additional information in the form of an Arboricultural Assessment (refer to the DA Guide) to assist in the determination. However, providing this assessment report does not guarantee that the work will be approved.

Note, Council does not undertake a comprehensive assessment of the tree as part of the application process, and staff are unable to provide advice on the health or structural condition of trees on private land.

#### *Arboricultural assessment requirements*

The arboricultural assessment report will only be accepted when prepared by an arborist with a minimum qualification of Level 5 under the Australian Qualification Framework.

The company preparing the report must not be financially affiliated or have a business relationship with a tree removal/pruning company.

(Refer to the DA Guide for more information).

#### E3.3.1 Matters to be considered—all applications

The following matters will be considered when assessing development applications and permit applications:

1. The species, health, structural condition, age, growing environment and landscape significance.
2. Where view pruning is proposed, the view pruning guidelines in the Woollahra Tree Management Policy 2011 will apply.
3. Where pruning for solar access is proposed, this will be considered making allowances for the tree's health, growth habit, structural stability and growing environment.
4. Where tree removal is proposed, the following matters will also be considered:
  - a) the surrounding canopy cover;
  - b) amenity issues; and
  - c) the opportunity for replacement planting.

---

### E3.3.2 Additional matters to be considered—works requiring a DA

---

The following additional matters will be considered when assessing development applications:

1. The impact of the proposed works, as assessed against the guidelines in *Australian Standard 4970 Protection of Trees on Development Sites*.  
Note: Where removal of the tree is approved, suitable replacement planting will form part of the conditions of development consent.
2. The contribution the tree provides to the canopy cover, amenity, environment and landscape of the immediate and surrounding area.
3. The visual prominence of the tree and its proximity to ridgelines, prominent places, the harbour and public open space.
4. For a tree on the Significant Tree Register—the impact of the proposed works on the amenity and landscape setting of the surrounding area.
5. For a heritage listed tree or a tree located in the grounds of a heritage listed property—the impact of the proposed works on the heritage significance of the item and its curtilage, and the amenity and landscape setting of the surrounding area. A heritage impact assessment may be required.
6. For a tree in heritage conservation areas—the impact of the proposed works on the heritage significance of the conservation area and the amenity and landscape setting of the surrounding area. A heritage impact assessment may be required.
7. Whether the proposal is to be sympathetic to the cultural and historical garden setting. The original garden layout and design should be retained where possible, particularly where the tree is located in an historic grand estate.
8. If the tree is proposed for removal, what replacement tree or trees will be provided? Well established gardens and trees should generally be retained. Replacement trees should be positioned and be of a species that reflect the original garden as much as possible.

### E3.3.3 Matters that do not justify tree removal or pruning

---

Generally approval will not be given where the proposed work is for the following:

1. Removal or pruning a tree for leaf, fruit or bark drop.
2. Removal of a tree for minor shading.
3. Removal of a tree for minor damage to infrastructure, such as retaining walls and pipes, where the damage can be repaired or the infrastructure restored with the retention of the tree.

Note: Limited space in the urban environment means tree roots can come into conflict with buildings. Tree removal will only be considered after alternative options that reduce conflict and accommodate tree growth have been explored. Removal is warranted where a tree is causing damage to a building or major damage to a retaining wall that forms a common boundary between two properties, which cannot be ameliorated through other means such as root pruning.



## E3.4 Exempt trees and works

Section 3.2.1 identifies that “any tree or palm, whether of indigenous, endemic, exotic or introduced species with a diameter spread of branches greater than 3m or with a height greater than 5m, irrespective of the spread of branches” is a prescribed tree for the purpose of Part 2.3 of the Biodiversity and Conservation SEPP.

Despite this, a permit or development application is not required for work to certain types of trees or works. These exemptions are identified below.

### E3.4.1 Exempt species

The following species of trees can be removed without a permit or development consent:

1. **Biosecurity species:** Removal of a species declared under the *Biosecurity Act 2015* as prescribed for the Woollahra Municipality; and
2. **Exempt species:** Tree removal or pruning of a species identified in Groups A and B, only where the prescribed tree:
  - a) is not identified in the Significant Tree Register;
  - b) is not identified as a heritage item in Schedule 5 of Woollahra LEP 2014; and
  - c) is not located on land identified as containing a heritage item in Schedule 5 of Woollahra LEP 2014, where the description of the heritage item includes the ‘grounds and garden’ or the like, and
  - d) is replaced with a tree (minimum pot size 100 litre at time of planting) suitable to the site and which has the potential to reach similar mature dimensions to the tree removed by provision of this clause.

**Group A:** Trees in this group can be removed irrespective of height

Botanical name	Common name	Botanical name	Common name
<i>Ailanthus altissima</i>	Tree of Heaven	<i>Nerium oleander</i>	Oleander
<i>Cupressocyparis leylandii</i>	Leyland Cypress	<i>Olea europea var. africana</i>	African Olive
<i>Erythrina spp</i>	Coral Trees	<i>Salix spp</i>	Willow
<i>Ficus elastica</i>	Rubber Tree	<i>Rhizomatous (running) bamboo</i>	Bamboo
<i>Gleditsia triacanthos</i>	Honey Locust	<i>Schefflera actinophylla</i>	Umbrella Tree
<i>Lagunana patersonii</i>	Norfolk Hibiscus	<i>Strelitzia nicolai</i>	Giant Bird of Paradise
<i>Musa cavendishii</i>	Banana	<i>Syagrus romanzoffianum</i>	Cocos Palm
<i>Ligustrum spp.</i>	Privet		

**Group B:** Trees in this group can be removed if less than 10m in height

Botanical name	Common name
<i>Cinnamomum camphora</i>	Camphor Laurel
<i>Celtis spp.</i>	Hackberry
<i>Populus spp</i>	Poplar

Note: Although approval to remove the tree is not required, notice of the work is required. The owner of the land where the tree is located must give Council written notice of the work at least seven days prior to the work commencing.

### E3.4.2 Exempt works

The following works can be undertaken without a permit or development consent:

1. **Dead trees:** Removal of dead trees or dead branches of a tree.  
Note: Ensure the tree is not leafless because it is a deciduous tree.
2. **Building clearance:** Pruning to remove branches no larger than 50mm in diameter at the nearest branch collar or junction to provide a maximum of 2m clearance to:
  - a) a roof;
  - b) an external face of a building; or
  - c) powerlines as set out under section 48 of the *Electricity Supply Act 1995*.
3. **Parasitic plants:** Removal of parasitic plants from a tree.
4. **Dangerous trees:** Removal or pruning where the tree poses an imminent danger to property or life. Documentary evidence demonstrating that the works are necessary to eliminate an immediate hazard is to be provided to Council by an arborist who holds a minimum Level 5 qualification under the Australian Qualification Framework.
5. **Council works:** Tree removal, pruning, maintenance and replacement by Council or its duly authorised servants or agents, on land owned by, or under the care, control and management of Council.

Work must be undertaken in accordance with the WorkCover NSW Code of Practice for the Amenity Tree Industry and the guidelines in Australian Standard AS 4373 Pruning of Amenity Trees.

# Chapter E4 Contaminated Land

Part E ► General Controls for All Development

CHAPTER E4 APPROVED ON 27 APRIL 2015  
AND COMMENCED ON 23 MAY 2015



# Chapter E4 ► Contaminated Land

## Contents

<b>E4.1</b>	<b>INTRODUCTION .....</b>	<b>1</b>
	E4.1.1 Land where this chapter applies .....	1
	E4.1.2 Development to which this chapter applies .....	1
	E4.1.3 Objectives .....	1
	E4.1.4 Relationship to other parts of the DCP .....	2
	E4.1.5 Relationship to other documents .....	2
<b>E4.2</b>	<b>MATTERS TO CONSIDER WHEN LODGING A DEVELOPMENT APPLICATION .....</b>	<b>3</b>
	E4.2.1 Initial evaluation .....	3
<b>E4.3</b>	<b>SITE INVESTIGATION PROCESS REQUIRED IF THE LAND MAY BE CONTAMINATED .....</b>	<b>5</b>
	E4.3.1 Stage 1 - Preliminary investigation .....	5
	E4.3.2 Stage 2 - Detailed investigation .....	6
	E4.3.3 Stage 3 - Remedial action plan .....	6
	E4.3.4 Stage 4 - Validation and monitoring .....	7
	E4.3.5 Notification .....	7
	E4.3.6 Site audit statements .....	7
<b>E4.4</b>	<b>MATTERS TO CONSIDER WHEN PREPARING A PLANNING PROPOSAL .....</b>	<b>8</b>
	<b>APPENDIX 1: SOME ACTIVITIES THAT MAY CAUSE CONTAMINATION .....</b>	<b>9</b>
	<b>APPENDIX 2: POTENTIAL SOURCES OF SITE HISTORY INFORMATION .....</b>	<b>10</b>
	<b>APPENDIX 3: POLICY ON ACCESS TO INFORMATION.....</b>	<b>11</b>



## E4.1 Introduction

Over time, the land within Woollahra has had many different uses including agricultural, commercial, industrial and residential. Areas have also been used to accommodate landfill. Some of these uses may cause land to become contaminated due to the generation of waste products and the use of chemicals, oils and fuels.

If land is contaminated, it can have serious effects on human health and the environment. These effects can have an immediate impact or become a problem in years to come. It is therefore important the land is free from contamination to ensure that the environment is protected for future generations.

When carrying out planning functions, Council is required by legislation to consider whether a previous land use has caused contamination of a site (this includes the potential risk of any future contamination). For example, when assessing development applications or preparing planning proposals, Council is to consider the possibility of land contamination and the implications it has for any proposed or permissible future uses of land.

This chapter identifies requirements for applicants when proposing development and is consistent with the State Government's planning requirements for managing contaminated land under *State Environmental Planning Policy No 55—Remediation of Land* (SEPP 55).

### E4.1.1 Land where this chapter applies

---

This chapter applies to all land within the Woollahra Municipality.

### E4.1.2 Development to which this chapter applies

---

This chapter applies to development that requires development consent.

This chapter also sets out Council's policy for considering contamination when preparing planning proposals, such as those involving a rezoning, and includes a statement on Council's policy on access to information regarding contamination.

### E4.1.3 Objectives

---

The objectives of this chapter are:

- 01 To establish a policy and procedural framework for integrating contaminated land management into the planning and development process consistent with SEPP 55 and the Guidelines.
- 02 To ensure that changes of land use will not increase the risk to health or the environment.
- 03 To avoid inappropriate restrictions on land use.
- 04 To provide information to support decision making and inform the community.

---

#### E4.1.4 Relationship to other parts of the DCP

---

All applications, regardless of whether relating to a residential, commercial, community or other land use, must undertake an initial evaluation for contamination as set out in Section 4.2.1 below.

This chapter is to be read in conjunction with the other parts of the DCP that are relevant to the development proposal, including:

- ▶ If located in a residential area—the controls in Part B: General residential, or Part C: Heritage Conservation Areas that apply to the land.
- ▶ If located in a business centre—the controls in Part D: Business Centres that apply to the land.
- ▶ Part F: Land Use Specific Controls - this part contains chapters on Child Care Centres, Educational Establishments, Licensed Premises and Telecommunications.

#### E4.1.5 Relationship to other documents

---

The New South Wales Government recognises that the management of contaminated land is a major issue for public agencies, industry and the community. It has established a statutory framework and supporting guidelines to provide a comprehensive, consistent, whole of government approach to contamination and remediation.

Some of the primary documents are identified below, and are to be read in conjunction with this chapter:

- ▶ *Contaminated Land Management Act 1997 (CLM Act)*;
- ▶ *State Environmental Planning Policy No. 55 Remediation of Land (SEPP 55)*; and
- ▶ *Managing Land Contamination: Planning Guidelines (SEPP 55 Guidelines)*.

Note: In this chapter certain terms have the meaning defined in the CLM Act, or SEPP 55.



## E4.2 Matters to consider when lodging a development application

When assessing development applications, section 79C(1) of the Act requires Council to consider “...the suitability of the site for the development”. The risk to health and the environment from contamination is included in the assessment.

Council must also consider clause 7(1) of SEPP 55, which states:

*(1) A consent authority must not consent to the carrying out of any development on land unless:*

- (a) it has considered whether the land is contaminated, and*
- (b) if the land is contaminated, it is satisfied that the land is suitable in its contaminated state (or will be suitable, after remediation) for the purpose for which the development is proposed to be carried out, and*
- (c) if the land requires remediation to be made suitable for the purpose for which the development is proposed to be carried out, it is satisfied that the land will be remediated before the land is used for that purpose.*

Section 4.2.1 below sets out the initial evaluation procedures for considering the likelihood that land the subject of a development application may be contaminated.

Restrictions may then be imposed to reduce the risk of exposure to contaminated materials to acceptable levels. These restrictions may be imposed, or resolved, at different stages of the planning and development process. For instance:

- ▶ If the contamination status of land is unknown, no change in use which may increase the risk of harm should occur until the land has been investigated.
- ▶ If contamination causes an unacceptable risk of harm the use of the land will be restricted to reduce the risk to acceptable levels.
- ▶ If remediation has reduced the risk to acceptable levels no restriction on land use is necessary.

### E4.2.1 Initial evaluation

#### Initial evaluation required for every development application

An initial evaluation must accompany every development application, except applications required to be accompanied by a preliminary investigation (see Section 4.3.1 below).

The initial evaluation is essential to determine whether contamination is an issue, and whether sufficient information is available to carry out a planning function.

The purpose of this initial evaluation is to determine whether land contamination is relevant to the decision being made and whether further information is required from the proponent. Land contamination may be an issue either because of the history of the subject land or the history of neighbouring land.

The initial evaluation should be based on available factual information, including current zoning and permissible uses, records from previous rezonings, development applications, building applications, construction certificates and property files.

A list of potential sources of site history information is provided in Appendix 2 of this chapter. In particular, the initial evaluation should provide details of:

- ▶ present use of the site;
- ▶ date the present use commenced;
- ▶ previous uses of the site (if known);
- ▶ present and previous uses of the adjoining land (if known);
- ▶ whether the present or previous uses of the site, and adjoining lands, were potentially contaminating uses as listed in Appendix 1; and
- ▶ whether there has been any testing or assessment of the site for land contamination.

The SEPP 55 Guidelines include a checklist of what should be considered when preparing the initial evaluation.

The initial evaluation should provide sufficient information to allow Council to proceed with an assessment of a development application.

The applicant is responsible for making the necessary enquiries to obtain the information required to be included in the initial evaluation. The initial evaluation must identify the source of the information on which the evaluation is based. For example, information may be sourced from Council's property files, local history library and oral history.

If the initial evaluation does not provide sufficient information, Council may require further information.

#### **Initial evaluation indicates the land may be affected by contamination**

If the initial evaluation indicates that there is, or may be, contamination on the land, or that contamination may affect the land, the applicant must investigate the site and provide Council with the further information. These further investigations are generally in the form of a site investigation process, consistent with the SEPP 55 Guidelines.

### E4.3 Site investigation process required if the land may be contaminated

The site investigation process involves more detail on gathering and interpreting information for making planning decisions.

The four stages of the site investigation process are:

- ▶ Stage 1 - Preliminary investigation
- ▶ Stage 2 - Detailed investigation
- ▶ Stage 3 - Remedial action plan
- ▶ Stage 4 - Validation and monitoring

The appropriate level of evaluation and investigation will depend upon the circumstances of each site.

The applicant is responsible for engaging someone to undertake the site investigation process. The investigations, plans, validation and monitoring must be prepared by a suitably qualified and experienced person, and carried out in accordance with the SEPP 55 Guidelines and any other guidelines by the Department of Environment and Heritage (OEH).

A summary of these stages is provided below. More detailed information is contained in the SEPP 55 Guidelines. Council will have regard to the relevant heads of consideration in Section 3.5 of the Guidelines when assessing any investigations, plans, validations and monitoring submitted.

#### E4.3.1 Stage 1 – Preliminary investigation

The main objectives of a preliminary investigation are to identify any past or present potentially contaminating activities, provide a preliminary assessment of any site contamination and, if required, provide a basis for a more detailed investigation.

Council will require a preliminary investigation to be submitted with a development application in accordance with clause 7(4) of SEPP 55 where:

7(4) *The land concerned is:*

- (a) *land that is within an investigation area,*
- (b) *land on which development for a purpose referred to in Table 1 of the contaminated land planning guidelines is being, or is known to have been, carried out,*
- (c) *to the extent to which it is proposed to carry out development on it for residential, educational, recreational or child care purposes, or for the purposes of a hospital—land:*
  - (i) *in relation to which there is no knowledge (or incomplete knowledge) as to whether development for a purpose referred to in Table 1 to the contaminated land planning guidelines has been carried out, and*
  - (ii) *on which it would have been lawful to carry out such development during any period in respect of which there is no knowledge (or incomplete knowledge).*

---

In accordance with the SEPP 55 Guidelines, Council may also require a preliminary investigation to be submitted when:

- ▶ The subject site or land in the vicinity is, or may be, associated with potentially contamination activities listed in Appendix 1 of this chapter but it is not known whether contamination exists.
- ▶ The land was, or is, regulated by a regulatory authority in relation to land contamination, and there is insufficient information available about the nature and extent of contamination.
- ▶ The land has been investigated or remediated but there is insufficient information available about the nature and extent of contamination, or the circumstances have changed.
- ▶ There are restrictions on, or conditions attached to, the use of the site by regulatory or planning authorities that are, or may be, related to contamination, but there is insufficient information available about the nature and extent of contamination.
- ▶ Council records have demonstrated that the land is associated with complaints about pollution or illegal dumping of wastes but it is not known whether contamination exists.
- ▶ A sensitive use including, but not necessarily limited to, residential, educational, recreational, hospital or childcare is proposed on the land and records on the site history are unclear about whether the land has been used in the past for a purpose listed in Appendix 1 of this chapter.

### **E4.3.2 Stage 2 – Detailed investigation**

---

The objectives of a detailed investigation are to:

- ▶ define the nature, extent and degree of contamination;
- ▶ assess potential risk posed by contaminants to health and the environment; and
- ▶ obtain sufficient information to develop a remedial action plan, if required.

A detailed investigation is necessary when a preliminary investigation indicates that the land is contaminated or that it is, or was formerly, used for an activity listed in Appendix 1 and a land use change is proposed that has the potential to increase the risk of exposure to contamination.

Refer to the SEPP 55 Guidelines for more information on what is to be included in a detailed investigation.

### **E4.3.3 Stage 3 – Remedial action plan**

---

If investigations find that contamination makes the land unsuitable for the proposed use and remediation is required, a remedial action plan must be prepared and submitted prior to Council making a determination.

Under SEPP 55, clause 9(e)(ii), remediation work in a heritage conservation area is Category 1 remediation work and therefore requires consent.

Refer to the SEPP 55 Guidelines for more information on what is to be included in a detailed investigation. Council reserves the right to require a site audit of the remedial action plan.

---

---

### E4.3.4 Stage 4 – Validation and monitoring

---

The objective of validation and monitoring is to demonstrate whether the objectives stated in the remedial action plan and any conditions of development consent have been achieved.

SEPP 55 requires a notice of completion for all remediation work.

### E4.3.5 Notification

---

Where Council or the applicant (including their consultant or site auditor) considers that the contamination at the subject site is significant and warrants regulation under the CLM Act, the OEH may need to be notified.

There is a legal duty on owners of land as well as persons whose activities have contaminated land to notify the OEH as soon as practicable after becoming aware that contamination poses a significant risk of harm to human health or the environment (see Section 60, CLM Act).

### E4.3.6 Site audit statements

---

A site audit is an independent review of any or all stages of the site investigation process, conducted in accordance with the CLM Act and the SEPP 55 Guidelines.

A site audit may review a preliminary investigation, a detailed investigation, a remedial action plan or a validation report. Council may require a site audit at any stage in the decision making process.

Under Section 3.6.1 of the SEPP 55 Guidelines, a site audit will be required if Council:

- ▶ believes on reasonable grounds that the information provided by the proponent is incorrect or incomplete;
- ▶ wishes to verify the information provided by the proponent adheres to appropriate standards, procedures and guidelines; and/or
- ▶ does not have the internal resources to conduct its own technical review.

A site audit will also be requested if legislation requires one.

The applicant is responsible for engaging a suitably qualified and experienced consultant to undertake a site audit statement in accordance with these guidelines.

A site audit will lead to the provision of a certificate called a site audit statement, stating the purpose for which the land is suitable. Only site auditors accredited by the OEH can issue site audit statements.

The NSW EPA has prepared guidelines (second edition draft) for the NSW Site Auditor Scheme June 2002, which provides guidelines on:

- ▶ the NSW Site Auditor Scheme;
  - ▶ process of appointing site auditors;
  - ▶ legal, administrative and technical directions; and
  - ▶ site auditors and the preparation of site audit statements.
-

---

#### **E4.4 Matters to consider when preparing a planning proposal**

In preparing planning proposals for rezoning land, consideration should be given to the possibility of the land being affected by contamination. The procedure for determining the risk of contamination is the same as the procedure for development applications in Section 4.2 above.

However, for planning proposals the procedure only applies if the proposed zone would permit a change of use on the land, and one of the following criteria is met:

- ▶ the land is significantly contaminated land (declared under the CLM Act);
- ▶ development for a purpose referred to in Appendix 1 of this chapter is being, or is known to have been carried out on the land; or
- ▶ it is proposed to carry out development on the land for residential, educational, recreational, child care purposes or a hospital, and there is an incomplete historical knowledge of the land, or it may have been previously lawful to carry out on the land a use identified in Appendix 1 of this chapter.

For all planning proposals, the onus will be on the applicant to demonstrate to Council that the site is suitable for the proposed rezoning. If Council is preparing a rezoning, it will ensure the requirements of SEPP 55 are met.

All planning proposals will be submitted to the Minister for Planning and Infrastructure for review. The Minister will determine whether or not the planning proposal should proceed.

## Appendix 1: Some activities that may cause contamination

The following activities may cause land contamination:

- ▶ acid/alkali plant and formulation;
- ▶ agricultural/horticultural activities;
- ▶ airports;
- ▶ asbestos production and disposal;
- ▶ chemicals manufacture and formulation;
- ▶ defence works;
- ▶ drum re-conditioning works;
- ▶ dry cleaning establishments;
- ▶ electrical manufacturing (transformers);
- ▶ electroplating and heat treatment premises;
- ▶ engine works;
- ▶ explosives industry;
- ▶ gas works;
- ▶ iron and steel works;
- ▶ landfill sites;
- ▶ metal treatment;
- ▶ mining and extractive industries;
- ▶ oil production and storage;
- ▶ paint formulation and manufacture;
- ▶ pesticide manufacture and formulation;
- ▶ power stations;
- ▶ railway yards;
- ▶ scrap yards;
- ▶ service stations;
- ▶ sheep and cattle dips;
- ▶ smelting and refining;
- ▶ tanning and associated trades;
- ▶ waste storage and treatment; and
- ▶ wood preservation.

Note: This appendix is a guide only. It is not sufficient to rely solely on the contents of this appendix to determine whether a site is likely to be contaminated or not.

A conclusive status can only be determined after a review of the site history and, if necessary, sampling and analysis. Due to the possibility of leaching and/or transmission of airborne contaminants, sites adjacent to those with an above listed use may also be at risk of contamination and warrant further investigation.

---

## Appendix 2: Potential sources of site history information

Potential sources of information about past and current activities that may indicate land contamination:

- ▶ NSW Department of Environment and Heritage;
- ▶ Sydney Water;
- ▶ WorkCover Authority of New South Wales;
- ▶ Energy Australia; and
- ▶ Local history libraries including the Woollahra Library Information Service.

Information on land contamination may be contained in a range of documents within Council's records. Access to these documents and information may be obtained in accordance with Council's policy on access to information. For example, Council records can also be searched for:

- ▶ historical development applications, building approvals and other approvals; and
- ▶ current and historical land use zoning.

Local history searches of a particular site (and adjoining sites) may indicate previous activities as listed in Appendix 1, could involve the following:

- ▶ Sand's Sydney and New South Wales Directory 1858 to 1932/3;
- ▶ local history publications;
- ▶ past and present telephone books;
- ▶ long term residents;
- ▶ current and past site workers;
- ▶ aerial photographs;
- ▶ historical development applications, building approvals and other approvals; and
- ▶ current and historical land use zoning.



## Appendix 3: Policy on access to information

Council has an important role in supplying information regarding land use history, land contamination and remediation. Council also has a statutory responsibility under section 59 of the CLM Act to include information about land contamination provided to Council by either the OEH or accredited auditors on planning certificates issued under section 149 (2) of the Act.

Knowledge about contamination and the relevance of contamination as an issue will change over time as land is investigated, remediated for particular uses, or as standards for remediation change to accommodate changing values.

### Section 149 planning certificate

Section 149(2) planning certificates issued by Council will contain certain information as prescribed by the CLM Act, section 59(2) to notify people that the land is significantly contaminated, or is the subject of a management order, approved voluntary management proposal, ongoing maintenance order, or site audit statement.

The section 149(2) planning certificate does not itself restrict the use of land. It is simply the mechanism for recording the fact that a Council policy applies which may restrict the use of land.

An application for a planning certificate under section 149(2) of the Act may be made for an individual property. That certificate will include responses to specific questions on land contamination.

In addition to the prescribed matters under the CLM Act, the Regulation requires Council to indicate on a section 149(2) planning certificate whether land is affected by an adopted policy that restricts development of land due to contamination.

This chapter is Council's policy on contaminated lands and may have the effect of restricting development on certain lands and will be referred to in the section 149(2) planning certificate. Accordingly, the following statement will be included on all section 149(2) planning certificates.

*Council has adopted by resolution a policy on contaminated land which may restrict the development of the land. This policy is implemented when zoning or land use changes are proposed on lands which have previously been used for certain purposes. Consideration of council's policy and the application of provisions under relevant State legislation is warranted.*

# Chapter E5 Waste Management

Part E ► General Controls for All Development

CHAPTER E5 APPROVED ON 27 APRIL 2015  
AND COMMENCED ON 23 MAY 2015

Last amended on 7 December 2020



# Chapter E5 ▶ Waste Management

## Contents

<b>E5.1 INTRODUCTION .....</b>	<b>1</b>
E5.1.1 Background .....	1
E5.1.2 Land to which this chapter applies .....	1
E5.1.3 Development types that this chapter applies to.....	1
E5.1.4 Objectives .....	1
E5.1.5 Relationship to other parts of the DCP .....	2
E5.1.6 Preparing your development application .....	2
<b>E5.2 DEMOLITION AND CONSTRUCTION PHASE.....</b>	<b>4</b>
<b>E5.3 ON-SITE WASTE AND RECYCLING CONTROLS FOR ALL DEVELOPMENT .....</b>	<b>5</b>
<b>E5.4 DWELLING HOUSES, SEMI-DETACHED DWELLINGS AND DUAL OCCUPANCIES.....</b>	<b>8</b>
<b>E5.5 RESIDENTIAL FLAT BUILDINGS, MANOR HOUSES, MULTI DWELLING HOUSING AND .....</b>	<b>.....</b>
<b>    MULTI DWELLING HOUSING (TERRACES) .....</b>	<b>9</b>
<b>E5.6 COMMERCIAL AND NON-RESIDENTIAL DEVELOPMENTS.....</b>	<b>12</b>
<b>E5.7 MIXED USE DEVELOPMENTS .....</b>	<b>14</b>



---

## E5.1 Introduction

### E5.1.1 Background

---

Waste and resource consumption is a major environmental issue and a priority for all levels of government within Australia. This is particularly the case as landfill sites become scarce and the environmental and economic costs of waste generation and disposal rise. Government and society alike are exposed to the issue of managing the increasingly large volumes of waste generated by society.

The building and construction industry in particular is a major contributor to waste, much of which is still deposited to landfill. Implementing effective waste minimisation strategies has the potential to significantly reduce these volumes as well as reduce costs. Well designed buildings that facilitate waste separation, recycling and composting support ongoing sustainability and recycling objectives.

This chapter identifies the on-site waste and recycling facilities that are to be included in the design of the development for its demolition, construction and ongoing use. It also identifies that a Site Waste Minimisation and Management Plan (SWMMP) is to be submitted with a development application (DA).

### E5.1.2 Land to which this chapter applies

---

This chapter applies to all land within the Woollahra Municipality.

### E5.1.3 Development types that this chapter applies to

---

This chapter applies to development that requires development consent, including development involving demolition and construction.

### E5.1.4 Objectives

---

The objectives of this chapter are:

- 01 To assist applicants in planning for sustainable waste management, through the preparation of a site waste minimisation and management plan.
- 02 To identify on-site requirements for waste and recycling storage and management, having regard to access and amenity.
- 03 To ensure waste management systems are compatible with collection services.
- 04 To minimise noise and nuisance arising from waste and recycling collection having regard to the need to balance operational needs and functions of businesses with the amenity of nearby residential uses, particularly between 10pm and 7am.

---

### E5.1.5 Relationship to other parts of the DCP

---

This chapter is to be read in conjunction with the other parts of the DCP that are relevant to the development proposal, including:

- ▶ If located in a residential area—the controls in Part B: General Residential, or Part C: Heritage Conservation Areas that apply to the land.
- ▶ If located in a business centre—the controls in Part D: Business centres that apply to the land.
- ▶ Part F: Land Use Specific Controls - this part contains chapters on Child Care Centres, Educational Establishments, Licensed Premises and Telecommunications.

### E5.1.6 Preparing your development application

---

#### On-site waste and recycling facilities

All DAs are to address the provisions in Section 5.2 and 5.3 of this chapter.

In addition, the following sections also apply to certain types of development:

- ▶ For dwelling houses, semi-detached dwellings and dual occupancies—refer to Section 5.4;
- ▶ For residential flat buildings, manor houses, multi dwelling housing and multi dwelling housing (terraces) —refer to Section 5.5;
- ▶ For commercial and non-residential development—refer to Section 5.6; and
- ▶ For mixed use development—refer to Section 5.7.

#### Site Waste Minimisation and Management Plan

The SWMMP outlines measures to minimise and manage waste generated during the demolition, construction, and ongoing use of the site.

The SWMMP identifies:

- ▶ volume and type of waste and recyclables to be generated;
- ▶ storage and treatment of waste and recyclables on site;
- ▶ disposal of residual waste and recyclables;
- ▶ operational procedures for ongoing waste management once the development is complete; and
- ▶ information to be shown on the DA plans.

Council's DA Guide contains a template for preparing the SWMMP. All information in the template is to be addressed.

Maximum waste minimisation and management benefits are achieved when the SWMMP is considered from the earliest stages of the development. It is for this reason that the SWMMP is generally required with the DA.

Council may allow an exception where both a DA and a construction certificate (CC) are required for a development. In such cases, a preliminary SWMMP may be required with the DA and the

final SWMMP details relating to the demolition and construction phases must be submitted to Council for approval prior to the CC being issued.



## E5.2 Demolition and construction phase

In the initial stages of development, attention to the design, estimating of materials and waste sensitive construction techniques and management practices, can achieve significant rewards in managing waste.

Demolition and construction activity should maximise resource recovery and minimise residual waste through waste avoidance, source separation and recycling. For example, applicants are encouraged to consider possible adaptive reuse of existing buildings, structures, and materials.

Objectives		Controls	
O1	To ensure that sustainable waste and recycling management is considered at the demolition and construction stages of development.	C1	A SWMMP is submitted with development application.  The SWMMP includes the following: a) the estimated volume of waste generated; to be separately identified for the demolition, construction and ongoing operation phases of development; b) the estimated volume of waste to be reused, recycled or disposed of; to be separately identified for the demolition, construction and ongoing operation phases of development; c) how waste and recyclables will be stored and collected during the demolition and construction phases; and d) measures for waste avoidance that have been incorporated into the design, material purchasing and construction techniques for the proposed development.
O2	To minimise waste during the demolition of buildings or structures.	C2	Development reuses or recycles salvaged materials onsite, where possible.
		C3	Development reuses or recycles excess construction materials, where possible.
O3	To encourage building design and construction techniques that minimise waste generation.	C4	Prefabricated components and recycled materials are used in the building, where possible.
		C5	Site disturbance and excavation is minimised.

### E5.3 On-site waste and recycling controls for all development

Waste and recycling facilities should be well designed and accessible to occupants and service providers, as the design affects use, amenity, and the movement and handling of waste for the life of the development.

Objectives		Controls	
O1	To ensure that development provides waste and recycling storage areas that meet the waste and recycling needs of tenants.	C1	<p>A SWMMP is submitted with the development application.</p> <p>The SWMMP identifies the waste and recycling storage areas, by showing on the plans, the location and size of:</p> <ul style="list-style-type: none"> <li>a) temporary indoor waste and recycling storage space for each dwelling or tenancy;</li> <li>b) onsite waste and recycling storage areas;</li> <li>c) individual and/or communal composting;</li> <li>d) waste collection points;</li> <li>e) garbage chutes and interim storage facilities for recyclable materials;</li> <li>f) any service rooms (for accessing a garbage chute) on each floor of the building;</li> <li>g) waste compaction equipment;</li> <li>h) waste collection point for the collecting and emptying waste, recycling and garden waste bins; and</li> <li>i) the path of travel for moving bins from the storage area to the collection point, where the collection is in a different location to the storage area. The width, height, grade and accessibility of the path of travel is to be identified.</li> </ul>
O2	To encourage source separation of waste, reuse, and recycling materials.	C2	Waste and recycling storage areas are designed so recyclable materials are separated from general waste.

Objectives		Controls	
O3	To ensure that waste and recycle areas are suitably designed and located and do not cause nuisance or negative impacts.	C3	Waste and recycling storage areas are located behind the building line or within non-habitable areas of the building.
		C4	Waste and recycling storage areas are integrated with the design of the overall development and do not detract from the streetscape. For example, external materials and finishes are a similar style and quality to the rest of the development.
		C5	Waste and recycling storage areas and composting areas are located so that the facility: <ul style="list-style-type: none"> <li>a) is convenient and safely located for occupants to access;</li> <li>b) has an unobstructed access to the waste and recycling collection point, free of steps and kerbs and does not have a grade more than 1:8;</li> <li>c) is secure and designed to minimise opportunities for vandalism; and</li> <li>d) does not reduce amenity for occupants of the site and adjoining properties, by way of visual, noise or olfactory impacts.</li> </ul>
		C6	Bulk bins, where permitted, are designed to be manually manoeuvred by one person in order to be serviced.

Objectives	Controls
<p>O4 To ensure that waste and recycling collection points are suitably located in regards to safety and amenity.</p>	<p>C7 Waste and recycling collection points do not impact on traffic and pedestrian safety.</p> <p>C8 Bins may be collected from a kerb side location where site characteristics, number of bins and length of street frontage do not compromise safety.</p> <p>C9 Where kerb side bin collection is not appropriate, bins are collected on site.</p> <p>C10 Where a collection vehicle is required to enter a property, access driveways and internal roads are designed in accordance with Australian Standard 2890.2 Parking Facilities - Off-Street Commercial Vehicle Facilities - 2002.</p> <p>C11 Waste and recycling collection points are located to allow collection vehicles to move in a continuous forward movement. Reversing should be avoided as it creates noise (from reverse beeping/alarms) and can also be less safe. If reversing is required the SWMMP accompanying the DA must justify why a continuous forward movement for collection cannot reasonably be accommodated.</p>

## E5.4 Dwelling houses, semi-detached dwellings and dual occupancies

Dwelling houses, semi-detached dwellings and dual occupancies are to be designed with suitably sized and located waste areas, and must provide opportunities for recycling and composting.

Note: The size of residential waste and recycling storage areas required in the heritage conservation areas of Paddington and the West Woollahra precinct, respond to the smaller lots typical in those areas.

Objectives	Controls
<p>O1 To promote reuse and recycling in dwelling houses, semi-detached dwellings and dual occupancies.</p>	<p>C1 Each dwelling has an indoor waste and recycling storage space of sufficient size to accommodate at least one day's waste and recycling generation.</p> <p>C2 Each dwelling has an onsite waste and recycling storage area either located externally behind the building line, or within a non-habitable area of the dwelling.</p> <p>C3 For a dwelling located in an area other than Paddington or West Woollahra, the size of the waste and recycling area accommodates:</p> <ul style="list-style-type: none"> <li>a) 1 x 120L general waste bin;</li> <li>b) 1 x 240L green waste bin; and</li> <li>c) 1 x 120L or 240L recycling bin.</li> </ul> <p>C4 For a dwelling located in Paddington or West Woollahra—the size of the waste and recycling area accommodates:</p> <ul style="list-style-type: none"> <li>a) 1 x 120L general waste bin or 1 x 55L bin;</li> <li>b) 1 x 120L or 55L green waste bin; and</li> <li>c) 2 x 55L recycling crates or 1 x 120L recycling bin.</li> </ul> <p>C5 Each dwelling has an area suitable to accommodate on-site composting.</p>

## E5.5 Residential flat buildings, manor houses, multi dwelling housing and multi dwelling housing (terraces)

The design of waste and recycling storage areas within residential flat buildings, manor houses, multi dwelling housing and multi dwelling housing (terraces) needs to address specific challenges with regard to waste volumes, ease of access and operation of waste sorting and removal systems.

Resources such as the *Better Practice Guide for Waste Management in Multi-Unit Dwellings* can also be used to inform design of medium density developments.

Objectives	Controls
<p>O1 To promote reuse and recycling in residential flat buildings, manor houses, multi dwelling housing and multi dwelling housing (terraces)</p>	<p>C1 Each dwelling is provided with an indoor waste and recycling cupboard (or other appropriate storage space) for the interim storage of a minimum one day’s garbage and recycling generation.</p> <p>C2 For residential flat buildings and manor houses, a communal waste and recycling storage area for housing bins is provided.</p> <p>C3 For multi dwelling housing and multi dwelling housing (terraces), a waste and recycling storage area is provided in the form of an area for each dwelling, or as communal waste and recycling storage area.</p> <p>C4 The size and design of the waste and recycling area or areas accommodate:</p> <ul style="list-style-type: none"> <li>a) 120L of residual waste per residential dwelling;</li> <li>b) 55L of recyclables per residential dwelling stored in colour coded, shared use, 120L and/or 240L mobile garbage bins;</li> <li>c) 240L shared use mobile garbage bins for food and garden organics.</li> </ul> <p>C5 An area or areas suitable to accommodate on-site composting is provided. This may be for a communal facility or an area for each dwelling.</p> <p>C6 Development containing 20 or more residential dwellings provides a garbage compaction unit.</p>

Objectives	Controls
	<p>C7 Bulk waste bins are not encouraged and should only be considered for developments containing 12 or more dwellings.</p>
<p>O2 To ensure that waste and recycling collection points are suitably located.</p>	<p>C8 Communal waste and recycling storage rooms should generally be located in a basement location within the main building envelope. Where the storage room is in a separate standalone structure, the room and access to it is designed consistent with Crime Prevention Through Environmental Design (CPTED) principles.</p> <p>C9 Development containing four or more storeys provides a suitable system for the transportation of waste and recyclables from each storey to waste storage and collection areas, such as a garbage chute. This is in addition to the central waste storage area.</p> <p>C10 Development containing 10 or more dwellings provides a dedicated room or caged area for the temporary storage of discarded bulky items which are awaiting removal. This storage area is readily accessible to all residents and located close to the main waste storage area.</p> <p>C11 The travel distance between the waste and recycling storage area to the collection point is not more than 75 metres. For development assessed using <i>State Environmental Planning Policy (Housing for Seniors or People with a Disability) 2004</i>, the maximum distance is 50m.</p> <p>C12 Collection and storage facilities are designed to provide an unobstructed and continuous accessible path of travel (as set out in the Australian Standard 1428 Design for Access and Mobility 2001) from the facility to:</p> <p>a) the entry of any adaptable housing;</p>

Objectives	Controls
	<ul style="list-style-type: none"><li>b) the principal entrance to each residential flat building and manor house; and</li><li>c) the point at which bins are emptied and collected.</li></ul>



## E5.6 Commercial and non-residential developments

Developments containing a range of different non-residential uses present unique waste minimisation opportunities and management requirements. Flexibility in size and layout is often required to cater for the different needs of multiple tenants as well as future changes in use.

Noise from waste management activities needs to be managed where commercial uses are located near residential and other noise sensitive uses, particularly between 10pm and 7am. For example, noise when bins are emptied into collection vehicles, especially glass, and the reversing alarms of collection vehicles, can be particularly disturbing when these occur at noise sensitive times, such as late at night or in the early hours of the morning when most people are sleeping.

Objectives		Controls	
O1	To promote reuse and recycling in mixed use development.	C1	A waste and recycling cupboard is provided for each individual kitchen area in the development, including kitchen areas in hotel rooms, motel rooms and staff food preparation areas.
O2	To ensure waste management systems are suitably located and readily accessible to occupants and service providers.	C2	Each waste and recycling cupboard is designed to hold a minimum of one day's waste and keep general waste separated from recyclable materials.
O3	To minimise nuisance and noise impacts on adjoining or nearby residential uses, from waste management associated with a pub, registered club, or other type of licensed premises with a capacity of 100 or more patrons.	C3	A goods lift may be included in multiple storey buildings.
		C4	The size of the waste and recycling storage area or areas is designed to accommodate the rates of waste generation and recyclable material generation identified in Table 1 below.
		C5	Bulk waste bins are not encouraged and should only be considered for developments containing 12 or more tenancies.
		C6	Waste and recycling containers should be collected from a rear lane access point, where possible.
		C7	The SWMMP submitted with the development application must include: <ul style="list-style-type: none"> <li>a) the location of glass and recycling collection and sorting areas, which are to be shown on the DA plans. Note the installation of a glass crushing machine is encouraged to minimise noise from glass sorting.</li> </ul>

Objectives	Controls
	b) the waste management operating procedures, including the collection times. These must minimise noise and disturbances to residential amenity, especially between 10pm and 7am.

**TABLE 1** Waste and recycling generation rates

Premises type	Waste generation	Recyclable material generation
Backpackers hotel	40L/occupant space/week	20L/occupant space/week
Boarding house, guest house	60L/occupant space/week	20L/occupant space/week
Food premises		
Butcher	80L/100m <sup>2</sup> of floor area/day	Variable
Delicatessen	80L/100m <sup>2</sup> of floor area/day	Variable
Fish shop	80L/100m <sup>2</sup> of floor area/day	Variable
Greengrocer	240L/100m <sup>2</sup> of floor area/day	80L/100m <sup>2</sup> of floor area/day
Restaurant/café	10L/1.5m <sup>2</sup> of floor area/day	2L/1.5m <sup>2</sup> of floor area/day
Supermarket	240L/100m <sup>2</sup> of floor area/day	240L/100m <sup>2</sup> of floor area/day
Takeaway food shop	80L/100m <sup>2</sup> of floor area/day	Variable
Hairdresser, beauty salon	60L/occupant space/week	Variable
Hotel, licensed club, motel	5L/bed space/day 50L/100m <sup>2</sup> of bar area/day 10L/1.5m <sup>2</sup> of dining area/day	1L/bed space/day 50L/100m <sup>2</sup> of bar area/day 50L/100m <sup>2</sup> of dining area/day
Offices	10L/100m <sup>2</sup> of floor area/day	10L/100m <sup>2</sup> of floor area/day
Shop up to 100m <sup>2</sup> floor area	50L/100m <sup>2</sup> of floor area/day	25L/100m <sup>2</sup> of floor area/day
Shop greater than 100m <sup>2</sup> floor area	50L/100m <sup>2</sup> of floor area/day	50L/100m <sup>2</sup> of floor area/day
Showroom	40L/100m <sup>2</sup> of floor area/day	10L/100m <sup>2</sup> of floor area/day

Source: Model Waste Chapter 2008 - Department of Environment and Climate Change

## E5.7 Mixed use developments

In mixed use development where residential and commercial land uses occur within the one building or development site, waste management needs to address the different demands and preserve residential amenity.

Objectives		Controls	
O1	To promote reuse and recycling in mixed use developments.	C1	The waste and recycling storage area for the residential component is separate to the waste storage area provided for the commercial component.
		C2	The controls in Section 5.5 (Residential flat buildings, manor houses, multi dwelling housing and multi dwelling housing (terraces)) apply to the residential component of mixed use development.
		C3	The controls in Section 5.6 (Commercial and non-residential developments) apply to the non-residential component of mixed use development.

# Chapter E6 Sustainability

Part E ► General Controls for All Development

CHAPTER E6 APPROVED ON 27 APRIL 2015  
AND COMMENCED ON 23 MAY 2015

Last amended on 22 December 2023



---

# Chapter E6 ▶ Sustainability

## Contents

<b>E6.1</b>	<b>INTRODUCTION .....</b>	<b>1</b>
	E6.1.1 Background .....	1
	E6.1.2 Land where this chapter applies .....	1
	E6.1.3 Development types to which this chapter applies .....	1
	E6.1.4 Objectives .....	1
	E6.1.5 Relationship to other parts of the DCP .....	2
	E6.1.6 Relationship to other documents.....	2
<b>E6.2</b>	<b>COMMERCIAL AND NON-RESIDENTIAL BUILDINGS.....</b>	<b>3</b>
<b>E6.3</b>	<b>SOLAR ENERGY SYSTEMS (INCLUDING SOLAR PANELS, SOLAR HOT WATER SYSTEMS AND SOLAR HEATING SYSTEMS) .....</b>	<b>7</b>



## E6.1 Introduction

### E6.1.1 Background

---

Ecologically sustainable development (ESD) seeks to integrate environmental, economic and social considerations in decision making. Building sustainability is an important consideration in the design, construction and ongoing use of buildings. Applying ESD principles to development helps minimise greenhouse gas emissions and reduce energy and water costs for households and businesses.

### E6.1.2 Land where this chapter applies

---

This chapter applies to all land within the Woollahra Municipality.

### E6.1.3 Development types to which this chapter applies

---

This chapter applies to the following development:

- ▶ commercial development that requires consent;
- ▶ non-residential development that requires consent;
- ▶ solar energy systems that do not meet the provisions in the *State Environmental Planning Policy (Transport and Infrastructure) 2021* (Transport and Infrastructure SEPP); and
- ▶ solar energy systems that meet the criteria in the Transport and Infrastructure SEPP but form part of other works that require consent.

#### Applying best practice to other development

Council encourages applicants to apply sustainability principles to all development. In particular, the design principles in the BASIX planning tool may be considered for alterations and additions to residential buildings that are less than \$50,000.

### E6.1.4 Objectives

---

The objectives of this chapter are:

- 01 To promote ESD in the design, construction and use of non-residential buildings.
- 02 To encourage the use of environmentally sustainable building materials.
- 03 To maximise the benefits of passive solar design.
- 04 To promote the use of renewable energy sources while minimising visual impacts, particularly when located in heritage conservation areas.



---

### E6.1.5 Relationship to other parts of the DCP

---

This chapter is to be read in conjunction with the other parts of the DCP that are relevant to the development proposal, including:

- ▶ If located in a residential area—the controls in Part B: General Residential, or Part C: Heritage Conservation Areas that apply to the land.
- ▶ If located in a business centre—the controls in Part D: Business Centres that apply to the land.
- ▶ Part F: Land Use Specific Controls - this part contains chapters on Child Care Centres, Educational Establishments, Licensed Premises and Telecommunications.

### E6.1.6 Relationship to other documents

---

#### State environmental planning policies

The State Government also requires sustainability to be considered in the design, construction and ongoing use of buildings. These requirements are set out in the following State environmental planning policies (SEPPs):

- ▶ *State Environmental Planning Policy (Sustainable Buildings) 2022* (Sustainable Buildings SEPP) —applies to residential and non-residential development and establishes sustainability requirements relating to water, energy and minimum performance levels for thermal comfort.
- ▶ Transport and Infrastructure SEPP—includes exempt and complying development provisions for the installation of the following types of solar energy systems: photovoltaic electricity generating systems, solar hot water systems, solar air heating systems.
- ▶ *Exempt and Complying Development 2008* (Codes SEPP)—includes exempt and complying development provisions for certain low impact developments including the installation of hot water systems, rainwater tanks, shade structures, skylights, roof windows and ventilators.

#### National Construction Code

National Construction Code (NCC), Section J, includes mandatory minimum energy performance requirements for Class 3 and Class 5 to 9 buildings. The objective is to reduce building greenhouse gas emissions by improving operational efficiency of buildings by addressing matters such as building fabric, thermal performance and glazing.

## E6.2 Commercial and non-residential buildings

This section seeks to promote ESD in commercial and non-residential development by minimising water use, fuel use and greenhouse gas emissions in the design, construction and use of buildings.

Development should seek to achieve a NABERS (National Australian Built Environment Ratings System) rating of at least 4 stars, or equivalent under other rating systems.

A 4 star rating represents “good performance” under the NABERS Energy and Water tool, which measures performance on a rating scale from 1 to 6 stars. A 4 star rating can be generally achieved through compliance with the National Construction Code and thoughtful building design and addressing such matters as identified in the table below.

Note: In addition to the building design matters identified in this chapter, applicants should have regard to the choice of internal fittings, as the energy performance of a building can be greatly improved by selecting water conservation devices (such as 4 star taps and 4 star dual flush toilets), energy efficient space heating and cooling systems, energy efficient lighting, and gas or electric boosted solar hot water systems.

Objectives	Controls
<p>O1 To promote sustainable buildings, design and construction.</p>	<p>C1 Office development with a gross floor area of at least 1,000m<sup>2</sup> achieves a minimum 4 star NABERS rating.</p> <p>Notes:</p> <ul style="list-style-type: none"> <li>i) C1 above applies to new development and work involving significant alterations and additions to existing development.</li> <li>ii) For the purpose of the above control, the calculation of gross floor area does not include parking, loading or vehicular access, to these areas.</li> <li>iii) To demonstrate that this rating will be achieved, the applicant is to submit with the DA:                             <ul style="list-style-type: none"> <li>a) an ESD Statement prepared by an accredited professional providing design evidence that a NABERS 4 star rating can be achieved; or</li> <li>b) evidence of a Commitment Agreement. A Commitment Agreement is a contract between the NABERS National Administrator, the Office of Environment and Heritage NSW (OEH) and the building proponent to design,</li> </ul> </li> </ul>

Objectives	Controls
	<p>build and commission the premises to achieve a NABERS Energy star rating of 4 or more.</p>
<p>O2 To design buildings to reduce the need for artificial heating and cooling, and artificial lighting during daylight hours.</p>	<p>C2 Building articulation, courtyards and light wells allow daylight into internal areas.</p> <p>C3 Windows for buildings are oriented towards the north for maximum solar access.</p> <p>C4 Building elements such as eaves, awnings, operable louvres, projecting sun shades, screens, blinds and balconies maximise solar access in winter and sun shading in summer.</p>
<p>O3 To ensure that window placement maximises opportunities for cross ventilation.</p>	<p>C5 Subject to privacy impacts to adjoining properties, buildings contain external windows to provide direct light and natural ventilation.</p> <p>C6 Subject to privacy impacts to adjoining properties, window openings are located in opposite walls and in line with each other to provide for natural cross ventilation.</p> <p>C7 Buildings are designed to facilitate convective currents. This may be by:</p> <ul style="list-style-type: none"> <li>a) locating small windows on the windward side and larger windows on the leeward side; and</li> <li>b) designing buildings to draw cool air in at lower levels and allowing warm air to escape at higher levels.</li> </ul>

Objectives	Controls
<p>O4 To ensure that the use of glazing maximises solar penetration during winter months.</p>	<p>C8 Main windows facing between 110° east and 110° west of north are designed to be energy efficient (i.e. low emissivity or double glazed).</p> <p>C9 Development provides appropriate sun protection during summer for glazed areas. Extensive areas of glazing are protected from sun during summer using shading devices. Unprotected tinted windows are not an acceptable solution.</p>
<p>O5 To reduce water consumption and encourage on-site water retention and re-use.</p>	<p>C10 For landscaped garden areas in commercial developments, building design incorporates the following measures to minimise mains water demand and consumption:</p> <ul style="list-style-type: none"> <li>a) rainwater tanks to supply water for plant watering, toilet flushing, outdoor cleaning and cooling systems for the building;</li> <li>b) where suitable, roof gardens to reduce stormwater run-off and provide insulation;</li> <li>c) an irrigation system to minimise waste water; and</li> <li>d) water retention within gardens to direct run-off from impervious uses and water tanks to deep soil areas.</li> </ul> <p>C11 Desalination plants are avoided. Desalination plants are not an appropriate water management option because they are an energy intensive and inefficient method for providing fresh water.</p>

---

Objectives	Controls
O6 To encourage tree selection that reduces the need for artificial heating and cooling of buildings.	C12 Subject to view impacts to adjoining properties, wide canopied deciduous trees are planted to the north of buildings to provide shade during warmer months and allow sunlight penetration during cooler months.  C13 Subject to view impacts to adjoining properties, evergreen trees are planted to the west and east of buildings to prevent glare and heat during warmer months.

### E6.3 Solar energy systems (including solar panels, solar hot water systems and solar heating systems)

A solar energy system includes a photovoltaic electricity generating system, solar hot water system, or solar air heating system.

These solar energy systems are often exempt or complying development under the *State Environmental Planning Policy (Transport and Infrastructure) 2021*.

However, a development application is required to be lodged for a solar energy system when the system does not meet the standards for exempt or complying development in the Transport and Infrastructure SEPP.

The controls also provide guidelines for the design and location of solar energy systems that form part of other works that require the development consent. For example, a development application for a dwelling house may include solar energy systems. In these cases, the solar energy system is assessed as part of the development proposal for the new building.

Note: **primary road** in this clause refers to the road to which the front of a dwelling house, or a main building, on a lot faces or is proposed to face.

Objectives	Controls
<p>O1 To minimise the amenity impacts of solar energy systems particularly in regard to streetscape impacts, scenic quality, visual impact and view loss.</p>	<p>C1 Solar energy system:</p> <ul style="list-style-type: none"> <li>a) should not have an unreasonable visual impact on:                             <ul style="list-style-type: none"> <li>i) the streetscape and scenic quality of the area;</li> <li>ii) the visual quality of the area when viewed from the harbour or a public recreation area;</li> <li>iii) the amenity of adjoining and adjacent properties;</li> <li>iv) existing harbour and city views obtained from private properties and</li> </ul> </li> <li>b) must not involve mirrors or lenses to reflect or concentrate sunlight.</li> </ul> <p>C2 For buildings in a heritage conservation area and buildings which are local or State heritage items, the solar energy system must meet the following location requirements:</p> <ul style="list-style-type: none"> <li>a) Does not protrude more than 500mm from the building (as measured from the point of attachment).</li> <li>b) Is not placed facing the primary road.</li> </ul>

Objectives	Controls
	<ul style="list-style-type: none"> <li>c) Is arranged neatly on the roof plane.</li> <li>d) Does not have a negative impact on the heritage significance of the item or heritage conservation area.</li> </ul> <p>C3 Where not located in a heritage conservation area or on a heritage item, the solar energy system must meet the following location requirements:</p> <ul style="list-style-type: none"> <li>a) For property in land zoned R2 Low Density Residential or R3 Medium Density Residential: <ul style="list-style-type: none"> <li>i) the system must not protrude more than 1m from the building (as measured from the point of attachment) or</li> <li>ii) where attached to a wall or roof facing a primary road, must not protrude more than 500mm from the building (as measured from the point of attachment).</li> </ul> </li> <li>b) For property not in land zoned R2 Low Density Residential or R3 Medium Density Residential: <ul style="list-style-type: none"> <li>i) the system must not protrude more than 1.5m from any building or structure to which it is attached (as measured from the point of attachment).</li> </ul> </li> </ul> <p>Note: A view analysis and/or heritage impact assessment may be required as a part of the DA to detail the extent of potential impacts.</p>

# Chapter E7 Signage

Part E ► General Controls for All Development

CHAPTER E7 APPROVED ON 27 APRIL 2015  
AND COMMENCED ON 23 MAY 2015

Last amended on 31 May 2024





---

# Chapter E7 ▶ Signage

## Contents

<b>E7.1</b>	<b>INTRODUCTION .....</b>	<b>1</b>
	E7.1.1 Land where this chapter applies .....	1
	E7.1.2 Development types that this chapter applies to.....	1
	E7.1.3 Objectives .....	2
	E7.1.4 Relationship to other parts of the DCP.....	2
	E7.1.5 Relationship to other documents.....	2
<b>E7.2</b>	<b>GENERAL SIGNAGE CONTROLS—ALL AREAS.....</b>	<b>3</b>
	E7.2.1 Building identification signs and business identification signs .....	4
	E7.2.2 When external painting of a building constitutes a wall sign .....	10
<b>E7.3</b>	<b>HERITAGE CONSERVATION AREAS AND ON HERITAGE ITEMS .....</b>	<b>11</b>
	E7.3.1 Signage in heritage conservation areas and on heritage items .....	12



## E7.1 Introduction

Signage includes an advertising structure, a building identification sign and a business identification sign. Under Woollahra Local Environmental Plan 2014 (Woollahra LEP), building identification signs and business identification signs are the only signs permitted in the Woollahra Municipality.

In Woollahra LEP these signs are defined as:

- ▶ “building identification sign” means a sign that identifies or names a building and that may include the name of a building, the street name and number of a building, and a logo or other symbol but does not include general advertising of products, goods or services.
- ▶ “business identification sign” means a sign:
  - a) that indicates:
    - (i) the name of the person or business, and
    - (ii) the nature of the business carried on by the person at the premises or place at which the sign is displayed; and
  - b) that may include the address of the premises or place and a logo or other symbol that identifies the business, but that does not contain any advertising relating to a person who does not carry on business at the premises or place.

This chapter identifies Council’s requirements for signage, addressing matters such as the type of sign, content, size, location and colour to ensure that signage communicates effectively and makes a positive contribution to the public domain.

### E7.1.1 Land where this chapter applies

---

This chapter applies to all land within the Woollahra Municipality.

### E7.1.2 Development types that this chapter applies to

---

Woollahra LEP 2014 only permits building identification signs and business identification signs; general advertising signs are prohibited.

This chapter applies to building identification signs and business identification signs that require consent, or that form part of other works that require consent.

This chapter does not apply to small scale and low impact signage identified as exempt development in Woollahra LEP 2014, Schedule 2 or *State Environmental Planning Policy (Exempt and Complying Development Codes) 2008*. However, if the requirements and development standards in the Codes SEPP or Woollahra LEP 2014 cannot be met, development consent is required and the provisions of this DCP chapter apply.

---

### E7.1.3 Objectives

---

The objectives of this chapter are:

- O1 To control the erection of building signs and business identification signs.
- O2 To ensure that signage conveys messages reasonable and relevant for the purpose of identifying buildings and individual businesses.
- O3 To ensure that signage in the centres is unobtrusive, informative and compatible with an attractive shopping environment.
- O4 To ensure that the location, size, colour and content of signs does not cause unreasonable visual clutter, or detract from the character of the building to which it is attached or the streetscape in which it is located.
- O5 To identify when external painting of a building constitutes a wall sign.

---

### E7.1.4 Relationship to other parts of the DCP

---

This chapter is to be read in conjunction with the other parts of the DCP that are relevant to the development proposal, including:

- ▶ If located in a residential area or heritage conservation area—the controls in Part B: General Residential, or Part C: Heritage Conservation Areas that apply to the land. Additional signage controls apply in some heritage conservation areas (HCA), such as William Street in Paddington. If there is an inconsistency between the controls in this chapter and the controls in Part C, the controls in Part C for the HCAs prevail.
- ▶ If located in a business centre—the controls in Part D: Business Centres that apply to the land.
- ▶ Part F: Land Use Specific Controls - this part contains chapters on Child Care Centres, Educational Establishments, Licensed Premises and Telecommunications.

---

### E7.1.5 Relationship to other documents

---

#### *State Environmental Planning Policy (Exempt and Complying Development Codes) 2008 (Codes SEPP)*

The Codes SEPP contains Division 2 Advertising and Signage Exempt Development Code. Under the code, common types of building and business identification signs and other signs, such as community notices and real estate signs, are exempt development if the standards are met.

#### **Woollahra LEP 2014**

Under Woollahra LEP 2014, Schedule 2, small scale and low impact building identification and wall signs may be undertaken as exempt development in heritage conservation areas or on heritage items if the criteria and standards are met.

## E7.2 General signage controls—all areas

Signage is essential to commercial premises, and suitable signage can add interest, character and vitality to the built environment. However poorly designed or placed signs, or too many signs in one location, can affect streetscape amenity.

It is important that commercial operators thinking about signage for their premises remember that acceptability of an impact depends not only on the extent of the impact but also on reasonableness of, and necessity for, the development that causes it. In other words, how many signs are reasonably required to convey the message that the premises is operating from the site?

Signage should never dominate and overwhelm the character of the street. It is important for signage to be well designed, appropriate in scale, and of a quality that enhances the character of the area and helps define a local identity.

The signage should be integrated with the building design. The design, size and colour of signs must not dominate or obscure the architectural character and detail of the building or adjoining buildings. Generally signage should occur below the awning level as signage above the awning level impacts on the visual cohesion of the streetscape.

The objectives and controls in this section apply to signs in the centres and residential areas; additional controls for signage in heritage conservation areas (HCA) also apply, and are set out in Section 7.3 of this chapter. If there is an inconsistency between these general controls and the controls for the HCAs, the controls for the HCAs prevail.



**FIGURE 1** Types of signs

- 1 Building identification sign – located on the parapet
- 2 Building identification sign – located on the façade bay
- 3 Fascia sign
- 4 Under awning sign
- 5 Top hamper sign
- 6 Window sign

Buildings in Woollahra’s business zones are predominantly mixed use, with active retail uses at street level and residential or office uses above. Typically an awning separates the retail frontage from the upper levels. The façade of the upper levels should not be used to advertise the business at street level.



**FIGURE 2**  
Example of signage on awning, top hamper and windows

### E7.2.1 Building identification signs and business identification signs

Objectives	Controls
<p>O1 To limit the types of signs on buildings to those signs that are less likely to contribute to visual clutter or be otherwise visually intrusive.</p>	<p>C1 The signage is:</p> <ul style="list-style-type: none"> <li>a) a building identification sign;</li> <li>b) a business identification sign that is:                             <ul style="list-style-type: none"> <li>i) wall sign (may be a flush wall or painted wall sign);</li> <li>ii) fascia sign, including a sun-blind attached to the outer edge of the fascia;</li> <li>iii) under awning sign;</li> <li>iv) top hamper sign;</li> <li>v) window sign.</li> </ul> </li> </ul> <p>Refer to Figure 1 above.</p>
<p>O2 To preserve the existing and future roofscapes and protect views.</p>	<p>C2 The signage is not one of the following types:</p> <ul style="list-style-type: none"> <li>a) roof or sky sign;</li> <li>b) vertical or horizontal projecting wall sign, other than a projecting wall sign in William Street as permitted in Part C of the DCP, Chapter C1 Paddington HCA;</li> </ul>

Objectives	Controls
	<ul style="list-style-type: none"> <li>c) pylon or pole sign;</li> <li>d) sky sign; or</li> <li>e) fin sign.</li> </ul>
<p>O3 To ensure that signage conveys relevant messages and images and provides effective communication in suitable locations.</p>	<p>C3 The signage is fixed to a building that has been lawfully constructed.</p> <p>C4 The signage relates to uses that have been lawfully established.</p>
<p>O4 To ensure that signage does not contribute to visual clutter or environmental degradation because of its content.</p>	<p>C5 The signage assists in way finding and pedestrian useability.</p> <p>C6 Signage relating to a particular business is attached to that section of the building occupied by that business.</p> <p>C7 The signage does not contain advertising that:           <ul style="list-style-type: none"> <li>a) promotes products or services not related to the business being conducted on the site; or</li> <li>b) is for a single product, unless that product is the only merchandise being sold by the business.</li> </ul> </p> <p>C8 For a building identification sign, the content is limited to:           <ul style="list-style-type: none"> <li>a) street number;</li> <li>b) name of the building; and</li> <li>c) one logo or graphic.</li> </ul> </p> <p>C9 For a business identification sign, the content is limited to:           <ul style="list-style-type: none"> <li>a) street number;</li> <li>b) name and general nature of the business;</li> <li>c) name of the proprietor or business (or both); and</li> <li>d) one recognised logo or trade name (or both).</li> </ul> </p>



Objectives	Controls
	<p>C10 If a corporate logo or graphic appears as part of the signage, it is compatible with the architecture, materials, finishes and colours of the building, and does not have an adverse impact on the character of the building or streetscape.</p>
<p>O5 To ensure that signage is sympathetic to the design and architectural character of the building.</p>	<p>C11 The signage is integrated with the architectural design of the building, having regard to the building composition, fenestration, materials, finishes and colours.</p> <p>C12 The signage does not obscure or extend over any architectural, decorative or other distinguishing feature of the building.</p> <p>C13 The signage is of a high quality design and finish.</p>
<p>O6 To ensure that signs do not contribute to visual clutter or environmental degradation of the public domain because of the type, size or location.</p> <p>O7 To ensure that signage is limited to that reasonably required to convey the message that a particular business is operating from the premises.</p> <p>O8 To ensure that signs are an appropriate size and scale for the building on which they are erected.</p> <p>O9 To ensure that signage is compatible with its context.</p> <p>O10 To protect the amenity of residential development.</p> <p>O11 To ensure that window signs do not compromise active and desirable pedestrian environments.</p>	<p>C14 For signage on a building in a business zone, the total signage area does not exceed a factor of 0.5m<sup>2</sup> for each metre of the building width at its frontage to a public road.</p> <p>C15 For a building identification sign, the sign:</p> <ul style="list-style-type: none"> <li>a) is located on the main façade of the building;</li> <li>b) is designed as an integral part of the façade;</li> <li>c) may be located above awning height; and</li> <li>d) is generally composed of content that is affixed to the building.</li> </ul> <p>Note: Not all buildings will have a building identification sign.</p>

Objectives	Controls
<p>O12 To create an active interface between ground level retail or commercial properties and the street.</p>	<p>C16 For a business identification sign located in a business zone, the sign:</p> <ul style="list-style-type: none"> <li>a) is located in that part of the building occupied by the business;</li> <li>b) is primarily located on the awning fascia and under the awning height of the building. Signs, other than walls signs, above the awning height should be avoided;</li> <li>c) does not face a service lane; and</li> <li>d) is not located on a side wall abutting a residential property.</li> </ul> <p>C17 Where there are multiple occupancies or uses within a single building or site:</p> <ul style="list-style-type: none"> <li>a) a coordinated approach to the location and design of signs is taken; and</li> <li>b) a directory of tenants is provided at the ground floor level.</li> </ul> <p>C18 For an under awning sign located in a business zone, there is no more than one sign per premises and the sign:</p> <ul style="list-style-type: none"> <li>a) is a maximum height of 300mm;</li> <li>b) is a maximum length of 2.6m (or two thirds the width of the footpath, whichever is the lesser);</li> <li>c) is not lower than 2.6m from the footpath level as measured from the bottom of the sign; and</li> <li>d) is a minimum distance of 3m from adjoining under awning signs.</li> </ul> <p>C19 For a flush wall or painted wall sign located in a business zone, the sign:</p> <ul style="list-style-type: none"> <li>a) does not exceed 5m<sup>2</sup>;</li> <li>b) does not extend over or block windows or other openings in the building;</li> <li>c) does not project more than 150mm from the wall;</li> </ul>

Objectives	Controls
	<p>d) does not protrude above the parapet or eaves; and</p> <p>e) is not illuminated.</p> <p>C20 No more than one flush wall or painted wall sign on any elevation of the building.</p> <p>Note: The external painting of a building may constitute a painted wall sign where the painting uses corporate colours and can be reasonably considered as branding. Refer to Section 7.2.2 below for circumstances when painting of a building may be a painted wall sign.</p> <p>C21 For a servicing and delivery sign, the sign does not exceed an area of 0.35m<sup>2</sup>.</p> <p>C22 For a window sign, the sign:</p> <p>a) does not cover more than 40% of the surface of the window in which it is displayed; and</p> <p>b) if illuminated, is internally illuminated only.</p> <p>C23 Blanked out windows or location of shelving, fixtures, or the like, that do not provide for transparency into the premises and an attractive interface to the street are avoided.</p>
<p>O13 To ensure that signage in residential zones is discrete and does not impact on the residential character.</p> <p>O14 To ensure that the purpose of signage in residential areas is to identify the business, but does not seek to blatantly advertise the business.</p>	<p>C24 For a flush wall or painted wall sign in a residential zone that is for a business other than a home business, home industry or home occupation—the sign does not exceed an area of 2.5m<sup>2</sup>, and no more than one per building.</p> <p>C25 The signage is positioned parallel to the property boundary.</p>
<p>O15 To ensure that signage does not contribute to visual clutter or environmental degradation because of its colour.</p>	<p>C26 The colours in the signage are compatible with the architecture, materials, finishes and colours of the building.</p>

Objectives	Controls
<p>O16 To ensure that the colour of signage is compatible with the character of the streetscape and the desired future character of the area where the signage is located.</p>	<p>C27 The colours do not have an adverse impact on the character of the building or streetscape.</p> <p>C28 Corporate colours may appear as part of the sign, but are not used as the principal or dominant colour scheme.</p> <p>C29 Where there are multiple occupancies or uses within a single building, a coordinated colour scheme for signs is provided.</p>
<p>O17 To ensure that the location and size of signs do not affect public safety.</p>	<p>C30 The signage does not obscure or interfere with safety, public directional or traffic signs.</p>
<p>O18 To ensure that the illumination of signage does not have an adverse impact on the amenity of the public domain or residential uses.</p>	<p>C31 Illuminated signage is avoided in the residential zones.</p>
<p>O19 To ensure that signs do not cause unreasonable distraction.</p>	<p>C32 Illuminated signage or floodlighting of signs minimises lightspill and does not adversely affect amenity, particularly residential amenity.</p> <p>C33 If the sign is illuminated, the cabling is concealed or integrated with the sign.</p> <p>C34 In the E1 zone, illumination from a neighbourhood shop, such as a convenience store or the like does not exceed a maximum horizontal luminance of 200 lux.</p> <p>C35 Signage does not involve:                     <ul style="list-style-type: none"> <li>a) mechanical or animated flashing, pulsing or moving parts;</li> <li>b) neon tubes or fluorescent lighting (located either externally or in a shopfront window); or</li> <li>c) banners, flags or spotlights.</li> </ul> </p>

---

## E7.2.2 When external painting of a building constitutes a wall sign

---

Branding a building by painting the facade in the business corporate colours should be avoided.

Generally corporate colours involve bright or primary colours. Such colours, when painted over large areas on a building or above the awning level, can be loud and distracting and often do not provide a well-mannered and thoughtful contribution to the streetscape.

The corporate colours tend to be inconsistent with the character of the centre and the palette of colours predominantly used in the centre. Furthermore, bright and primary colours on buildings have the effect of adding to the perceived building bulk.

Individual business branding and identity in external painting and colour schemes is to be subordinate to the main colour scheme on the building.

Where it is established that a particular colour or combination of colours used to paint a building has the effect of a sign promoting a particular business, that work may be regulated through the development application process, and the provisions in this chapter of the DCP apply, specifically those controls for a painted wall sign.

### When the external painting of a building constitutes a wall sign

The external painting of a building is taken to constitute a wall sign if any of the following apply:

- a) The use of colours in patterns, symbols, messages or other devices promotes the business, a product, an event or an activity.
- b) The use of colours in patterns, symbols, messages or other devices conveys information, instructions or directions.
- c) When a business, activity or event is readily identifiable from a colour or a colour scheme and regularly uses that colour or colour scheme in its branding.

Painted and flat mounted wall signs tend to be visually prominent, particularly where the building is located on a corner site. It therefore important that the size and location of these signs on the building are controlled to ensure that the sign is not intrusive or unreasonably dominant, having regard to the streetscape and desired future character of the centre.

### Controls for a painted wall sign

The controls for a flush wall sign are in Section 7.2 above. These controls, amongst other things, limit the size of the sign to 5m<sup>2</sup>.

### E7.3 Heritage conservation areas and on heritage items

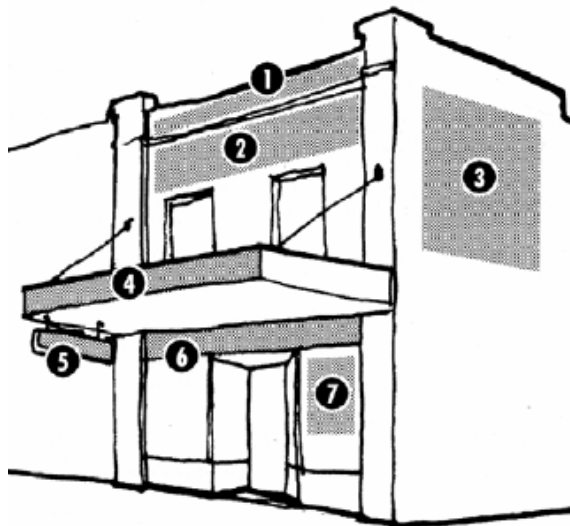
Signage within heritage conservation areas and on heritage items is to be sympathetic with heritage significance of the place or item.

Traditionally, signage to retail and other commercial buildings was painted directly on building elements. Old photographs show that signs were painted on building wall parapet panels, verandah and awning fascias or directly onto glazing. Broadly there was an integration of signage with the building. The colour of the signs and signwriting typically included light brown, rich brown, Indian red, chrome green, and in rare instances Prussian blue, black and dark tints, and slate grey, as well as gold and silver leaf.

While replication of older signage is not the aim, reference to lettering styles, traditional locations and colours should be made.

Locating signs on buildings not originally intended for retail use is more difficult, and particular attention is needed as these signs have the potential for a greater impact on heritage significance.

The objectives and controls in this section apply in addition to the general controls in Section 7.2 above. If there is an inconsistency between these controls and the general controls, the controls in this section prevail. However, if there is an inconsistency between these controls and any control in Part C of the DCP on the heritage conservation areas, the controls in Part C prevail.



**FIGURE 3** Types of signs

- 1 Parapet sign
- 2 Upper level facade sign
- 3 Flush wall and painted wall sign
- 4 Fascia sign
- 5 Under awning sign
- 6 Top hamper sign
- 7 Window sign

### E7.3.1 Signage in heritage conservation areas and on heritage items

Objectives		Controls	
O1	To conserve existing signs which have heritage significance.	C1	Existing signs with heritage significance should be retained and conserved.
O2	To minimise the number of signs.	C2	Signs should be located on the traditional areas for signs in heritage conservation areas as shown in Figure 3 above.
O3	To provide for signs in appropriate locations on buildings.	C3	The number of signs is limited to those necessary to display the name of the business and/or proprietor and the name of the building (if applicable).
O4	To minimise the impact of signs on the heritage significance of individual buildings and the heritage conservation area generally.	C4	The content of the signage has minimum reference to the particular service provided or products retailed from the premises.
O5	To ensure that the size of signs do not dominate the architectural character of the building or adjoining buildings.	C5	Where the building contains more than two tenants, a directory of tenants is provided at ground floor level on a secondary external wall.
O6	To ensure that the size of signs respond appropriately to the physical context and historical background of the streetscape and HCA as a whole.	C6	For a painted window sign, the sign does not dominate or clutter the shop front window.
		C7	A painted window sign on an upper storey window may only be considered for the identification of tenants where appropriate wall surfaces or other areas for signage are not available.
		C8	For a top hamper sign, the sign: <ul style="list-style-type: none"> <li>a) may be painted;</li> <li>b) is flush to the external face of the shopfront where practicable, but in any case does not project more than 100mm;</li> <li>c) is a maximum 600mm wide;</li> <li>d) is a maximum 6000mm long; and</li> <li>e) terminates 600mm short of each side boundary.</li> </ul>

Objectives	Controls
	<p>C9 For a flush wall or painted wall sign, the sign:</p> <ul style="list-style-type: none"> <li>a) is not constructed or installed on a heritage item;</li> <li>b) does not exceed an area of 2.5m<sup>2</sup>; and</li> <li>c) is no more than one per building.</li> </ul> <p>C10 Notwithstanding C1-C9 above, for a sign in William Street, Paddington, on a residential building used for commercial purposes, the number and type of signs are set out in Refer to Part C of the DCP, Chapter C1 Paddington HCA.</p>
<p>O6 To ensure that signs do not dominate or obscure the architectural character and detail of a building or a group of buildings.</p> <p>O7 To ensure that design, style and colours of signs complement the historic character of the streetscape but not mimic historic signage.</p>	<p>C11 The signage is not directly fixed by any means to sandstone or face brickwork, but may be fixed into mortar joints.</p> <p>C12 The signage is not painted on original face brickwork, sandstone, terracotta and glazed or tessellated tiling, or any other surface that is traditionally unpainted or unfinished by other mediums.</p> <p>C13 No demolition of any part of the structure or building on the site may occur to accommodate the signage.</p> <p>C14 Materials are restricted to those which were traditionally used for signs, including painted timber or board, engraved metal plaque such as bronze or painted masonry. With the exception of metal plaque, these materials are characterised by their non-reflectively.</p> <p>C15 Colours used in the signage are suitable for the architectural style and period of the building. The use of fluorescent paints and iridescent colours are not appropriate.</p>



Objectives	Controls
	<p>C16 The design and style of lettering in the signage is suitable for the style of the building and the historic character of the area.</p> <p>C17 Where a number of tenancies occupy the same building or row of properties, the signage is consistent in regards to shape, background colour, size, fixing methods and lighting. Consistent fonts and graphics are encouraged.</p> <p>C18 Consistency in signs between neighbouring buildings which have a common architectural style, whether traditional or contemporary is encouraged.</p>
<p>O8 To ensure lighting or illumination of signs does not impact on the heritage fabric or presentation of the place.</p>	<p>C19 Where lighting is required, the sign is painted and externally spotlit.</p> <p>C20 Internally lit signs, neon signs or signs with neon lettering are generally inappropriate and may only be considered if the sign is inside the shop window and is small and discrete.</p>

# Chapter E8

## Adaptable Housing

Part E ► General Controls for All Development

CHAPTER E8 APPROVED ON 27 APRIL 2015  
AND COMMENCED ON 23 MAY 2015

Last amended on 7 December 2020



# Chapter E8 ▶ Adaptable Housing

## Contents

<b>E8.1</b>	<b>INTRODUCTION .....</b>	<b>1</b>
	E8.1.1 Land where this chapter applies .....	1
	E8.1.2 Development to which this chapter applies .....	1
	E8.1.3 Objectives .....	2
	E8.1.4 Relationship to other parts of the DCP .....	2
	E8.1.5 Relationship to other documents.....	2
<b>E8.2</b>	<b>ADAPTABLE HOUSING .....</b>	<b>4</b>



## E8.1 Introduction

Disability discrimination happens when people with a disability are treated less fairly than people without a disability. Under the Commonwealth *Disability Discrimination Act 1992* (DDA) it is unlawful to discriminate against people with a disability in most areas of life; including for example providing access to, and the use of, premises.

The Commonwealth Government's requirements for accessibility to buildings are primarily established in:

- ▶ *Disability (Access to Premises - buildings) Standards 2010*, including the Access Code; and
- ▶ National Construction Code Series - Section D Part D3 - Access for People with a Disability.

These requirements are mandatory and set the minimum requirements for access that must be achieved. It is the responsibility of all applicants to identify and apply these mandatory provisions when designing a building.

In addition to the above requirements for accessibility to buildings, Council has requirements for the provision of adaptable housing in this chapter.

An adaptable dwelling is a dwelling that is designed so that it can be easily modified in the future to become accessible to both occupants and visitors with a disability or progressive frailties.

Applicants are required to implement these DCP provisions when designing buildings so we can achieve best practice and increase the provision of adaptable housing stock.

### E8.1.1 Land where this chapter applies

---

This chapter applies to all land within the Woollahra Municipality.

### E8.1.2 Development to which this chapter applies

---

This chapter of the DCP applies to the following types of development:

- ▶ dwelling houses;
- ▶ semi-detached dwellings;
- ▶ dual occupancies;
- ▶ attached dwellings;
- ▶ multi dwelling housing;
- ▶ multi dwelling housing (terraces);
- ▶ manor houses;
- ▶ residential flat buildings; and
- ▶ shop top housing.

---

### E8.1.3 Objectives

---

The objectives of this chapter are:

- 01 To promote the social welfare of the community through the provision of adaptable housing.
- 02 To ensure that housing options exist for people with a disability through the provision of adaptable housing.
- 03 To promote sustainable development by extending the use of buildings through the provision of adaptable housing requirements and by increasing the number of adaptable dwellings in the local government area.

### E8.1.4 Relationship to other parts of the DCP

---

This chapter contains provisions for increasing the stock of adaptable housing. It is to be read in conjunction with the others part of the DCP that are relevant to the development proposal, including:

- ▶ If located in a residential area—the controls in Part B: General residential, or Part C: Heritage Conservation Areas that apply to the land.
- ▶ If located in a business centre—the controls in Part D: Business Centres that apply to the land.

### E8.1.5 Relationship to other documents

---

#### *Disability Discrimination Act 1992*

The Commonwealth *Disability Discrimination Act 1992* (DDA) provides protection for everyone in Australia against discrimination based on disability. It encourages everyone to be involved in implementing the DDA and to share in the overall benefits to the community and the economy that flow from participation by the widest range of people.

Section 23 of the DDA covers access to premises and makes it unlawful to discriminate against a person with disability in relation to access to, or use of, premises including access to premises.

#### *Disability (Access to Premises - Buildings) Standards 2010 including the Access Code for Buildings*

The Premises Standards detail and codify the general requirements of the DDA by setting minimum requirements for the provision of access. The Premises Standards and Access Code calls up Australian Standards relating to disability access and parking including, AS 1428.1 - Design for access and mobility and AS 2890.6 - Off street parking for people with disabilities.

### **National Construction Code**

Part D3 of the National Construction Code (NCC) specifies minimum access requirements for buildings and is similar to the Access Code. The NCC applies to certain types of specified Class 1b buildings, Class 2 to Class 10 buildings excluding Class 4 buildings, and calls up the same Australian Standards as the Access Code.

### ***State Environmental Planning Policy (Housing for Seniors or People with a Disability) 2004***

Accessibility for Seniors Housing is to be provided in accordance with the requirements of the State Environmental Planning Policy (Housing for Seniors or People with a Disability) 2004.



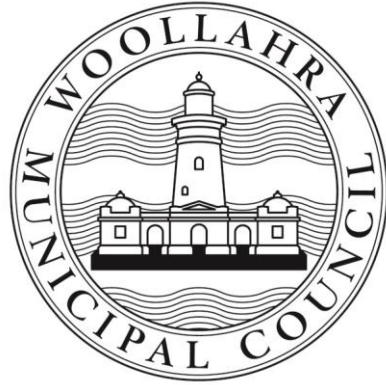
## E8.2 Adaptable housing

An adaptable dwelling is a dwelling that can be modified to be an accessible dwelling.

An accessible dwelling is a dwelling designed and built to accommodate the needs of people with a disability, and which complies with the AS 1428 - Design for access and mobility.

An applicant will need to demonstrate compliance with the adaptable housing provisions. This may include a report prepared by an appropriately qualified person submitted with the development application, specifying how the proposal has addressed the requirements in this chapter, the relevant Australian Standards and the National Construction Code.

Objectives		Controls	
O1	To increase the amount of building stock that provides for adaptable housing.	C1	Development for an attached dwelling, multi dwelling housing, multi dwelling housing (terraces), manor houses, residential flat building or shop top housing containing 10 or more dwellings, designs and constructs at least 10% of the dwellings to Class A certification under AS 4299 - Adaptable housing.
O2	To provide opportunities for dwellings to be readily converted into accessible dwellings to meet the current and future needs of the community.	C2	Development for a dwelling house or dual occupancy is encouraged to provide adaptable housing design.



## Part F ► Land Use Specific Controls

WOOLLAHRA DEVELOPMENT CONTROL PLAN 2015



# Chapter F1

## Child Care Centres

Part F ► Land Use Specific Controls

CHAPTER F1 APPROVED ON 27 APRIL 2015  
AND COMMENCED ON 23 MAY 2015



---

# Chapter F1 ► Child Care Centres

## Contents

<b>F1.1</b>	<b>INTRODUCTION .....</b>	<b>1</b>
	F1.1.1 Background .....	1
	F1.1.2 Land where this chapter applies .....	2
	F1.1.3 Development to which this chapter applies .....	2
	F1.1.4 Objectives .....	2
	F1.1.5 Relationship to other parts of the DCP .....	3
	F1.1.6 Relationship to other documents .....	3
<b>F1.2</b>	<b>PREPARING YOUR DEVELOPMENT APPLICATION .....</b>	<b>5</b>
<b>F1.3</b>	<b>PLANNING AND DESIGN OF CHILD CARE CENTRES .....</b>	<b>6</b>
	F1.3.1 Streetscape .....	6
	F1.3.2 Visual and acoustic impacts .....	7
	F1.3.3 Pick-up, drop-off and parking .....	9
	F1.3.4 Design of child care centre: internal layout and design .....	11
	F1.3.5 Design of child care centre: indoor and outdoor areas .....	14



## F1.1 Introduction

### F1.1.1 Background

#### Regulatory framework

Since 1 January 2012 most early childhood education and care services in New South Wales are regulated under a scheme known as the National Quality Framework (NQF). The NQF was agreed to by the Council of Australian Governments and established under an applied law system<sup>1</sup> comprising the *Children (Education and Care Services National Law Applications) Act 2010* and the *National Education and Care Services Regulations*. The Department of Education and Communities (DEC) is responsible for administering the NQF in NSW.

Both Council and the State Government have a role in the approvals process for a child care centre.

From Council, the applicant needs development consent. The consent is issued under the EP&A Act and specifies that the use may be permitted on a specific parcel of land.

In addition to development consent, the applicant requires a service approval (previously called a licence) from the State Government. It is an offence to operate an education and care service without a service approval.

The DEC is responsible for issuing service approvals and assessing child care service providers compliance with the Regulations. The Regulations outline the minimum requirements to operate a service, and include matters such as staff-to-children ratios and minimum areas for indoor and outdoor open space play areas.

The National Quality Standard sets a National Benchmark for the quality of education and care services. Services are later assessed and rated against the standards, including the physical environment (Quality Area 3) and how these impact on the service provided.

The DCP provisions in this chapter reflect the spirit and intent of the NQS by encouraging best practice physical environments in child care services, whilst also addressing neighbourhood and streetscape amenity issues.

#### Child care needs in Woollahra

Child care providers are encouraged to establish centres where the ratio of child care places for different age groups responds to demographic need.

Providers should have particular regard to the *Woollahra Council Child Care Needs Study (2014)* by CRED Community Planning, which identified that the main gap for child care in the Woollahra Municipality is for places for children under 2 years of age.

---

<sup>1</sup> The National Law is not a Commonwealth Law. A national applied law is a way of establishing national laws whereby a host jurisdiction (in this case Victoria) passes a law (the *Education and Care Services National Law Act 2010* (Vic)) and other jurisdictions adopt that law or pass corresponding legislation.



---

As at the 2011 census, 39% of all 0-5 year olds in the municipality were aged under 2 years. At the time of the study, there were places to service 12.5% of all children aged 0-2; this equated to 169 places for under 2 year olds, which was only 14% of all places offered. In comparison, supply of places for children under 2 years in other nearby council areas is much higher i.e. between 25-28% of all places.

### F1.1.2 Land where this chapter applies

---

This chapter applies to all land within the Woollahra Municipality.

### F1.1.3 Development to which this chapter applies

---

Development for the purpose of a child care centre requires consent. The controls in this chapter apply to centre based child care, such as:

- ▶ long day care;
- ▶ pre-school care; and
- ▶ out of school hours care.

This includes construction of new centres and expansion or alterations to existing centres.

The chapter does not apply to family day care, home-based child care for less than seven children, including no more than four who ordinarily attend school or informal child-minding services.

#### Remember:

An application to the DEC for a service approval may not be made until development consent has been obtained. However, consent from Council does not guarantee a service approval from DEC.

It is important that an applicant, when preparing the development application to Council, addresses not only the DCP provisions in this chapter, but also the requirements in the National Regulations and Standards, particularly in regards to building design and layout and the provision of amenities such as open space.

### F1.1.4 Objectives

---

The objectives of this chapter are:

- 01 To ensure child care centres are appropriately designed to a high level of safety, security, environmental health and amenity for their users, and provide an environment conducive to a high quality child care program.
- 02 To encourage child care providers to establish centres where the ratio of child care places for different age groups responds to demographic need.

- 
- O3 To ensure that child care centres minimise amenity impacts to surrounding properties in terms of privacy, traffic generation and availability of on-street parking.
- O4 To ensure adequate parking is available for the dropping off and picking up of children and to provide for the safe pedestrian transfer of children to and from the centre.

### F1.1.5 Relationship to other parts of the DCP

---

This chapter is to be read in conjunction with the other parts of the DCP that are relevant to the development proposal, including:

- ▶ If located in a residential area—the controls in Part B General Residential, or Part C Heritage Conservation Areas, that apply to the land.
- ▶ If located in a business centre—the controls in Part D Business Centres that apply to the land.
- ▶ Part E: General Controls for All Development - this part contains chapters on Parking and Access, Stormwater and Flood Risk Management, Tree Management, Contaminated Land, Waste Management, Sustainability, Signage and Adaptable Housing.

### F1.1.6 Relationship to other documents

---

#### National Law for child care services

The Education and Care Services National Law provides a jointly governed, uniform and integrated national approach to the regulation and quality assessment of education and care services across Australia.

The National Law sets out the objectives and guiding principles for the National Quality Framework.

The National Regulations provide detail on the minimum operational and physical space requirements for a child care service. In particular, Schedule 1 of the Regulation includes the National Quality Standard (NQS).

The NQS sets a national benchmark for the quality of education and care services. The NQS is used to assess education and care services to determine quality rating levels.

In NSW the Department of Education and Communities is responsible for assessing child care service providers against the National Quality Standard, and awarding a rating ranging from “Excellent”, “Exceeding National Quality Standard”, “Meeting National Quality Standard”, “Working Towards National Quality Standard” to “Significant Improvement Required”.

The design, layout and amenities provided by a child care centre are important elements contributing to service approval and rating level.

### **Building Code of Australia**

The Building Code of Australia establishes requirements for physical facilities in education and care buildings. Matters addressed include, but are not limited to: food preparation areas, the height of fences, number and size of toilet pans and hand basins, requirements relating to nappy change benches and bathing facilities, visibility of children's bathrooms, and playground surfacing.

### **Food and premises standards**

The Australian Standard 'Design, construction and fit-out of food premises' (AS 4674-2004) applies. The Standard ensures that design, construction and fit-out of food premises are maintained at high standards to facilitate the production of food, and includes requirements for food preparation and food storage areas.

Child care centres must also comply with food standards, and any licencing or notification requirements established by the NSW Food Authority.

---

## F1.2 Preparing your development application

The following matters are to be considered when preparing a development application (DA) for a child care centre:

- ▶ the National Quality Framework including the National Regulations and Quality Standards;
- ▶ provisions of this DCP;
- ▶ initial consultation with neighbours about the proposed child care facility;
- ▶ suitability of the land for use a child care centre; for example, is the land affected by acid sulfate soils, or does it contain contaminated material; and
- ▶ suitability of the building; for example, does the building contain lead-based paints or any other toxins/hazards to children.

### Site analysis to be submitted with the DA

A site analysis is to be submitted with the DA addressing the following matters:

- ▶ site orientation and solar access;
- ▶ existing vegetation;
- ▶ topography;
- ▶ retention of any special features/qualities of the site;
- ▶ views to and from the site;
- ▶ access (vehicular and pedestrian) to and from the site;
- ▶ parking and loading arrangements;
- ▶ location and uses of surrounding buildings;
- ▶ predominant built form and character;
- ▶ the provision of well proportioned windows to allow for access to natural light into rooms and views to the outdoors;
- ▶ access to natural cross ventilation;
- ▶ outdoor spaces suitable for children's play areas, including the size and topography;
- ▶ visual and acoustic privacy; and
- ▶ potential contamination.

## F1.3 Planning and design of child care centres

It is important that child care centres are designed to be compatible with the surrounding land uses. This compatibility needs to be reflected in the built form as well as the operation and management of the centre, as these all contribute to potential amenity, noise and privacy impacts.

To help identify and assess the potential impacts of a proposed child care centre on the surrounding area, a centre operation plan, acoustic study and traffic and parking management plan must be submitted with the development application. The centre operation plan should provide details about the proposed number of children (by age and total), the number of staff, hours of operation and a sample daily routine.

### F1.3.1 Streetscape

F1.3 Planning and design of child care centres ▶ 1.3.1 Streetscape			
Objectives		Controls	
O1	To ensure the child care centre integrates with the character of the existing streetscape and built form.	C1	The child care centre is designed to be consistent with the character of the streetscape. (Refer to the relevant residential or business centre controls in Part B, C or D of this DCP).
O2	To ensure that the size, scale and bulk of the child care centre is sympathetic to and consistent with the bulk and scale of surrounding development.	C2	The child care centre complies with the building envelope controls that apply to the precinct or centre where the centre is proposed. (Refer to the relevant residential or business centre controls in Part B, C or D of this DCP).
O3	To ensure that business identification signs do not detract from streetscape amenity by way of size, colour or location on the site.	C3	Refer to Part E of this DCP, Chapter E7 Signage.
O4	To ensure that business identification signs in residential areas are discrete and compatible with the residential context.		

### F1.3.2 Visual and acoustic impacts

F1.3 Planning and design of child care centres ► 1.3.2 Visual and acoustic impacts	
Objectives	Controls
<p>O1 To ensure that child care centres are designed and operated to minimise unreasonable noise impacts to adjoining properties and surrounding properties.</p> <p>O2 To ensure that noise from outdoor play areas is not continuous, or of such long duration to have an unreasonable impact on residential amenity.</p>	<p>C1 The child care centre minimises disturbance to adjacent, nearby and surrounding properties by suitable:</p> <ul style="list-style-type: none"> <li>a) design and siting of the facility (including for example, the layout of building, maximising separation between active and open outdoor play areas and the façade of any neighbouring properties, soft close gates, noise barriers, fencing and the use of noise absorbing materials); and</li> <li>b) operational management, such as the programming of noise emitting activities.</li> </ul> <p>Notes:</p> <p>A centre operation plan is to be submitted with the DA. The centre operation plan must address matters including daily program of activities, noise generating activities such as playing music and instruments, outdoor play, child drop-off and pick-up activity, mechanical plant and delivery vehicles.</p> <p>An acoustic study, prepared by a qualified practicing acoustic engineer, is to be submitted with the DA. Reference should be made to the Association of Australian Acoustical Consultants “Technical Guideline Child Care Centre Noise Assessment” for identifying how background noise is to be measured, and for the assumed sound power level of various noise sources.</p> <p>C2 Garbage and recycling bins are located and stored to minimise noise and odour impacts to adjoining properties.</p>

**F1.3 Planning and design of child care centres** ▶ 1.3.2 *Visual and acoustic impacts*

Objectives		Controls	
O3	To protect the visual privacy of the children, staff and other users of the child care centre.	C3	The child care centre complies with the visual privacy controls in this DCP. (Refer to the relevant residential or business centre controls in Part B, C or D of this DCP).
O4	To minimise adverse impacts on the visual privacy of adjoining and surrounding properties.	C4	The location and design of open spaces, playground areas and balconies, terraces or the like, accessible to the children, minimise any direct views to or from neighbouring and surrounding properties.

### F1.3.3 Pick-up, drop-off and parking

Vehicular and pedestrian access needs to provide for the safe transfer of children to and from the centre, as well as minimise detrimental impacts on traffic flow.

When considering a site for a child care centre, generally it is important to consider options available for providing parking and safe drop off and pick up arrangements. For example:

- Sites with on-site parking and drop off facilities, or within business centres, are preferred.
- Sites located on arterial roads should be avoided on safety grounds, as these roads have high traffic volumes and speeds.
- Sites that cannot provide on-site parking and drop off and pick up areas are not encouraged. Council will only consider such proposals if the child care centre is not located on an arterial road, and the applicant can demonstrate that there is adequate on-street parking vacancy rates such that the child care centre users will not unreasonably impact on the availability of on-street parking now or in the future. Council will not provide a dedicated on-street pick-up and drop-off zone for childcare centres.

A traffic management plan is to be submitted with the DA.

F1.3 Planning and design of child care centres ► 1.3.3 Traffic, parking and access	
Objectives	Controls
O1 To ensure adequate parking is provided for staff and visitors.	C1 Staff and visitor parking is provided on-site at the rate set out in Part E of this DCP, Chapter E1 Parking and Access.
O2 To ensure a safe environment for pedestrians (especially children), motorists and cyclists surrounding the child care centre.	C2 On-site vehicular movements are separated from pedestrian access and play areas by safety fencing, gates or other means.
O3 To ensure that drop-off, pick-up and parking activity does not detrimentally affect the availability of on-street parking and traffic flow in the local area.	C3 Development provides an on-site drop off and pick up area, which preferably: <ul style="list-style-type: none"> <li>a) is in the form of a one way driveway;</li> <li>b) incorporates a passing bay; and</li> <li>c) accommodates on-site the number of vehicles expected during the drop off and pick up times based on the 98th percentile queue length.</li> </ul>
O4 To ensure that vehicular access to and from the site does not detrimentally affect the traffic safety of surrounding properties.	C4 A child care centre that cannot provide the drop off and pick up area on-site will only be considered if the applicant can demonstrate that:



**F1.3 Planning and design of child care centres** ▶ *1.3.3 Traffic, parking and access*

**Objectives**

**Controls**

- a) the centre is not located on an arterial road;
- b) there is adequate on-street parking vacancy rates such that the child care centre users will not unreasonably impact on the availability of on-street parking now or in the future; and
- c) the walking catchment does not require the crossing of any arterial, sub-arterial or collector roads that do not have existing pedestrian crossing facilities within the catchment area.

Note: A traffic management plan, prepared by a suitably qualified traffic engineer, is to be submitted with the DA.

### F1.3.4 Design of child care centre: internal layout and design

The physical environment of a child care centre plays a critical role in keeping children safe; reducing the risk of unintentional injuries; contributing to their wellbeing, happiness, creativity and developing independence; and determining the quality of children’s learning and experiences.

Council’s DCP controls for internal layout and design support the requirements in the National Quality Standard regarding “Quality Area 3: Physical environment”, and can assist in providing an environment that contributes to a quality service.

F1.3 Planning and design of child care centres	
► 1.3.4 Design of child care centre: internal layout and design	
Objectives	Controls
O1 To encourage child care providers to establish centres where the ratio of child care places for different age groups responds to demographic need.	C1 Long day care centres are encouraged to include places for children under 2 years old, preferably at least 30% of the total number of places.
O2 To ensure the premises is designed to facilitate safety and supervision.	<p>C2 The design of indoor space provides opportunity for casual surveillance to entry and exit points to the site.</p> <p>C3 Areas regularly accessed by children are designed to allow clear lines of sight to facilitate supervision, particularly from:</p> <ul style="list-style-type: none"> <li>a) indoor to outdoor play areas; and</li> <li>b) indoor and outdoor play areas to children’s bathrooms and nappy changing areas.</li> </ul>
O3 To ensure exposure to natural sunlight and ventilation to reduce the spread of infection and odours.	C4 Indoor play areas have windows on external walls that allow the direct transmission of natural light.
O4 To assist in providing a comfortable environment.	C5 Play areas, cot rooms and bathrooms are naturally ventilated, such as by open windows and doors. Where natural ventilation cannot be reasonably provided, the indoor space may be ventilated through the use of an air conditioning system.

**F1.3 Planning and design of child care centres****▶ 1.3.4 Design of child care centre: internal layout and design**

Objectives	Controls
O5 To ensure that children have convenient access to bathrooms.	C6 Children's bathrooms are directly or easily accessible from indoor and outdoor play areas to facilitate supervision and encourage the independence of children.
O6 To ensure that children's bathrooms and toilet facilities are safe and designed to be developmentally and age appropriate.	C7 Children's bathrooms are designed for easy access and use by children, and include age appropriate toilets, hand basins, and bathing or showering facilities.
O7 To ensure that adequate nappy changing and related facilities are provided in services for children under 3 years.	<p>Note: To be shown on the DA plans.</p> <p>C8 Nappy change facilities are located and designed to allow visibility to and from the play area.</p> <p>C9 Nappy change facilities include:</p> <ul style="list-style-type: none"> <li>a) hand basin for adult hand washing;</li> <li>b) separate baby bath or small inset laundry tub; and</li> <li>c) bench for nappy changing.</li> </ul> <p>Note: To be shown on the DA plans.</p>
O8 To ensure sufficient space is provided for administrative functions.	<p>C10 A room or an office area, separate from the play area used by the children, is provided for administration and private consultation with parents.</p> <p>C11 A room or area, separate from the play area used by the children, is provided for staff respite.</p> <p>Note: These are to be shown on the DA plans.</p>

**F1.3 Planning and design of child care centres**

▶ 1.3.4 Design of child care centre: internal layout and design

Objectives	Controls
<p>O9 To ensure that child care centres are designed to ensure quick and safe evacuation in the event of fire or other emergencies.</p>	<p>C12 Where proposed in a multi-storey building, children’s play areas are generally located on the ground level, unless it is demonstrated that adequate emergency access and egress is available. For example, a fire isolated safe haven area may be provided that opens directly onto a dedicated fire-isolated stair.</p> <p>Note: DAs for a child care centre located more than one storey above the ground level may be referred to NSW Fire and Rescue for comment. Emergency evacuation plans should be submitted with the DA.</p> <p>C13 A child care centre located more than one level above ground has a smoke detection system installed throughout the building in accordance with the requirements of Specification E2.2a Clause 4 of the BCA.</p>

### F1.3.5 Design of child care centre: indoor and outdoor areas

Wherever possible, children need opportunities to be outdoors. This can be achieved with integrated and well designed indoor and outdoor environments that are available for use at the same time.

Council's DCP controls support the requirements in the National Quality Standard regarding "Quality Area 3: Physical environment" and may assist a service provider in getting a higher rating under national quality rating and assessment process.

#### F1.3 Planning and design of child care centres

##### ▶ 1.3.5 Design of child care centre: indoor and outdoor areas

Objectives	Controls
<p>O1 To ensure indoor spaces are designed to engage children in quality experiences that provide for learning and development.</p>	<p>C1 The indoor play area provides a minimum 3.25m<sup>2</sup>/child of unencumbered play space.</p> <p>C2 The indoor play area provides craft preparation areas include sinks. These sinks are separate from the kitchen and bathroom sinks.</p> <p>Note: To be shown on the DA plans.</p>
<p>O2 To ensure that age appropriate quiet areas are provided for rest and sleeping.</p>	<p>C3 A separate sleep room is provided for children under 2 years of age.</p> <p>Note: To be shown on the DA plans.</p>
<p>O3 To minimise noise impact to adjoining and surrounding properties.</p>	<p>C4 The active and open parts of the outdoor play area are adequately separated from the living and bedroom windows of surrounding dwellings. (Also refer to Section 1.3.2 Visual and acoustic impacts above.)</p>
<p>O4 To ensure that adequate and well designed outdoor spaces are provided to cater for the children's physical and developmental needs.</p> <p>O5 To ensure that outdoor spaces provide for safe and stimulating environments for children.</p>	<p>C5 The outdoor play area provides a minimum 7m<sup>2</sup>/child of unencumbered outdoor space. Incidental boundary clearances, such as side setbacks, less than 2.5m in depth are not calculated as part of the outdoor play areas.</p> <p>Note: This is a minimum requirement; exceeding the minimum may contribute to a better quality physical environment</p>

F1.3 Planning and design of child care centres	
► 1.3.5 Design of child care centre: indoor and outdoor areas	
Objectives	Controls
	for the children.
	<p>C6 The outdoor play area provides for both active and quiet play opportunities, and should generally include: an open area of approx. 1/3 of the playground for gross motor activities such as running; approx. 1/3 of the playground for active physical play such as climbing; and approx. 1/3 of the playground for focused play like sandpits, craft (including formal quiet areas for contained play).</p> <p>Note: To be shown on the landscape plan.</p>
	<p>C7 At least 50% of the outdoor play area is unencumbered and available for free active and physical play.</p>
	<p>C8 The outdoor play area is to include a variety of surfaces such as grass, sand, hard paving and mounding.</p> <p>Note: To be shown on the landscape plan.</p>
	<p>C9 The outdoor play area is designed to provide separate areas for different age groups that suit their needs and abilities.</p> <p>Note: To be shown on the landscape plan and addressed in the centre operation plan.</p>
	<p>C10 The outdoor play areas are:</p> <ul style="list-style-type: none"> <li>a) directly accessible from indoor play areas, preferably at grade;</li> <li>b) located to have immediate access to children’s toilets;</li> <li>c) located (where practicable) to the northern or north-eastern end of the site, and not to the south of the building, for good solar access;</li> <li>d) designed and configured to enable clear sight lines to areas of the playground to facilitate effective supervision;</li> </ul>

F1.3 Planning and design of child care centres	
▶ 1.3.5 Design of child care centre: indoor and outdoor areas	
Objectives	Controls
	<ul style="list-style-type: none"> <li>e) adequately separated from the main entrance of the child care centre, car parking area, vehicle circulation areas and garbage storage; and</li> <li>f) adequately fenced on all sides: all gates are self-closing and child proof with child proof locks; and fencing to adjoining public spaces is a minimum height of 1.8m.</li> </ul>
<p>O6 To ensure the appropriate landscaping of outdoor play areas used by children.</p>	<p>C11 Vegetation is free of toxins or safety hazards such as seeds, poisonous, spikey or potentially dangerous plants.</p> <p>C12 Landscaping provides for:</p> <ul style="list-style-type: none"> <li>a) shade protection;</li> <li>b) delineation of playing areas including small spaces and larger active areas; and</li> <li>c) children to explore and experience the natural environment through the inclusion of plants, trees, edible gardens, rocks and other elements from nature.</li> </ul>
<p>O7 To encourage sustainable water use.</p>	<p>C13 A rainwater tank of at least 2,000 litres is installed on site.</p>

# Chapter F2

## Educational Establishments

Part F ► Land Use Specific Controls

CHAPTER F2 APPROVED ON 27 APRIL 2015

AND COMMENCED ON 23 MAY 2015





# Chapter F2 ► Educational Establishments

## Contents

<b>F2.1</b>	<b>INTRODUCTION .....</b>	<b>1</b>
	F2.1.1 Background .....	1
	F2.1.2 Land where this chapter applies .....	1
	F2.1.3 Development to which this chapter applies .....	1
	F2.1.4 Objectives .....	1
	F2.1.5 Relationship to other parts of the DCP .....	2
	F2.1.6 Relationship to other documents .....	2
	F2.1.7 Definitions .....	3
<b>F2.2</b>	<b>BUILDING AND URBAN DESIGN .....</b>	<b>4</b>
<b>F2.3</b>	<b>SITING OF DEVELOPMENT .....</b>	<b>6</b>
<b>F2.4</b>	<b>HERITAGE CONSERVATION .....</b>	<b>8</b>
<b>F2.5</b>	<b>OPEN SPACES.....</b>	<b>9</b>
<b>F2.6</b>	<b>TRAFFIC, PARKING AND ACCESS .....</b>	<b>10</b>
<b>F2.7</b>	<b>PLANTING, FENCING AND HARD SURFACES .....</b>	<b>13</b>
<b>F2.8</b>	<b>COMMUNITY USE.....</b>	<b>15</b>



## F2.1 Introduction

### F2.1.1 Background

---

Educational establishments have a significant role to play in the Woollahra Municipality. They provide a learning forum whilst also providing community meeting points, sporting facilities and employment.

This chapter aims to achieve the rational and orderly development of educational establishments, such as schools and TAFEs, within the Municipality of Woollahra. It advocates a balance between providing buildings to meet the educational needs of the community, whilst protecting the amenity of the location and minimising impacts on the neighbouring land.

### F2.1.2 Land where this chapter applies

---

This chapter applies to all land within the Woollahra Municipality.

### F2.1.3 Development to which this chapter applies

---

#### Development requiring consent

This chapter applies to development for educational establishments that require consent.

#### Development permitted without consent

Under clause 29 of *State Environmental Planning Policy (Infrastructure) 2007*, certain development is permitted without consent. Council must be notified of the intention to carry out the development, and invited to provide comment.

The provisions in this chapter of the DCP should be considered by the proponent when considering such development. The provisions also establish the key principles that will inform Council's response to a notice to carry out development permitted without consent.

### F2.1.4 Objectives

---

The objectives of this chapter are:

- 01 To encourage well designed educational establishments that balance the requirements of students and staff, with the amenity of the adjacent properties.
- 02 To protect views and vistas.
- 03 To protect and conserve heritage conservation areas, and heritage items located on or adjacent to an educational establishment.

- 
- 04 To encourage all schools to provide sufficient open spaces on site, and protect existing open spaces.
  - 05 To encourage a safe, efficient and co-ordinated traffic network which considers all users.
  - 06 To encourage community uses of educational establishments that do not unreasonably impact on surrounding residents.

### F2.1.5 Relationship to other parts of the DCP

---

This chapter is to be read in conjunction with the other parts of the DCP that are relevant to the development proposal, including:

- ▶ If located in a residential area—the controls in Part B: General Residential, or Part C: Heritage Conservation Areas that apply to the land.
- ▶ If located in a business centre—the controls in Part D: Business Centres that apply to the land.
- ▶ Part E: General Controls for All Development - this part contains chapters on Parking and Access, Stormwater and Flood Risk Management, Tree Management, Contaminated Land, Waste Management, Sustainability, Signage and Adaptable Housing.

### F2.1.6 Relationship to other documents

---

#### *State Environmental Planning Policy (Infrastructure) 2007*

The SEPP applies to a range of key infrastructure types across NSW, including educational establishments.

The SEPP identifies certain low scale work as development without consent, if it is in connection with an existing educational establishment. This includes the construction of a library no more than one storey high, or a portable classroom. The proponent of such development must notify Council of its intention to carry out the development, and give consideration to any response to the notice.

The SEPP also permits as exempt and complying development a variety of development associated with educational establishments. For example, a library building is complying development if it is not more than 12m high and meets a number of other development standards.

Consent is required for development that is not exempt or complying development, or development permitted without consent. Under the SEPP, development for the purpose of educational establishments may be carried out with consent on all residential and business zoned land.

### F2.1.7 Definitions

---

The definitions below define words and expressions for the purpose of this chapter.

These definitions apply in addition to the definitions in Part A Chapter A3 of the DCP, the EP&&Act and the Woollahra LEP 2014.

**open space**                      The area on the establishment which is used for playgrounds, sport fields or for green or landscaped areas and may include associated structures and vegetation.

**playground**                      External spaces used by students during play and break times, and may be partly covered by shade structures.

**sports field or court**              Any open spaces, open to the air, used for sport and physical education and includes outdoor courts such as tennis or netball courts.

## F2.2 Building and urban design

Throughout the municipality, school buildings are significant contributors to the quality of the built environment, and often make a considerable contribution to the quality of the public domain.

Educational establishments have an important function in their community but their functional requirements result in buildings that are different to the built form of residential development. The development, including the buildings, landscaping, parking and other elements, should be well designed to meet the requirements of the establishment, whilst taking into consideration the nature of adjoining uses and the character of the streetscape.

The streetscape includes the combination of elements that create the urban form and character of that street, including in the public domain elements such as kerbs and pavements, landscaping and street furniture, and private domain elements fronting the street such as building facades, awnings, gardens and the like.

F2.2 Building and urban design	
Objectives	Controls
<p>O1 To encourage well designed buildings.</p> <p>O2 To encourage buildings that positively contribute to the streetscape and character of the location.</p>	<p>C1 Development incorporates a high standard of architectural design, materials and detailing appropriate to the building type and location.</p> <p>C2 The development has a clearly distinguishable street entry point which contributes to the streetscape.</p> <p>C3 Development on the boundary provides a sympathetic transition in terms of height, scale, bulk and materials.</p>
<p>O3 To encourage sustainable design.</p>	<p>C4 Development with a gross floor area of at least 1,000m<sup>2</sup> achieves a minimum 4 star NABERS rating.</p> <p>C5 Development is designed to provide for best practice environmentally sustainable design outcomes.</p> <p>Examples of environmentally sustainable design include:</p> <ul style="list-style-type: none"> <li>a) passive solar design principles to avoid the need for additional heating and cooling;</li> <li>b) natural ventilation in all buildings;</li> </ul>

**F2.2 Building and urban design**

**Objectives**

**Controls**

- c) roof-top solar energy panels where there is no negative impact on the significance of a heritage item or heritage conservation area;
- d) where appropriate green roofs are encouraged;
- e) windows are suitably shaded to restrict summer sun whilst permitting winter sun;
- f) use of low emission and renewable energy sources;
- g) use of recycled and/or low embodied energy building materials; and
- h) limited or minimised excavation.



## F2.3 Siting of development

Development in connection with educational establishments needs to take into account adjoining uses to ensure that the siting and location of buildings will have minimal impacts on the amenity of the adjoining properties, surrounding community and existing views and vistas.

F2.3 Siting of development	
Objectives	Controls
O1 To protect and promote the amenity of the public domain.	C1 Development complies with the street setback controls that apply to the precinct or centre where the centre is proposed. (Refer to the relevant residential or business centre controls in Part B, C or D of this DCP.)
O2 To protect and promote sunlight access on neighbouring land.	<p>C2 Non-street fronting rear and side setbacks of the building are setback so that sunlight is provided to adjoining residential properties:</p> <ul style="list-style-type: none"> <li>a) to 50% or 35m<sup>2</sup> (with minimum dimension 2.5m), whichever is smaller of the main ground level private open space of adjacent properties; and</li> <li>b) for a minimum of two hours between 9am and 3pm on June 21.</li> </ul> <p>C3 Where existing buildings overshadow greater than that specified in C2, sunlight access is not further reduced.</p>
O3 To sympathetically integrate the educational establishment into the surrounding neighbourhood to protect acoustic and visual privacy.	<p>C4 Rear and side setbacks of the building are setback to maintain the amenity of the adjoining development, taking into account privacy and noise generation.</p> <p>C5 Development provides visual privacy to adjoining properties by appropriate design, vegetative screening, window and door offset, location of external areas such as roof top terraces, screening devices, separation distances and the like.</p>

<b>F2.3 Siting of development</b>	
<b>Objectives</b>	<b>Controls</b>
O4 To protect existing views and vistas.	<p>C6 Development is sited so significant views and vistas from the public domain are maintained.</p> <p>C7 Development provides for view sharing from surrounding properties.</p>

## F2.4 Heritage conservation

Established schools are a source of cultural and heritage significance. Woollahra LEP 2014 lists a number of schools as containing heritage items, and several are located within heritage conservation areas. As part of a development application relating to, or in the vicinity of, a heritage item the Council may require the submission of a heritage impact statement or conservation management plan or both.

F2.4 Heritage conservation	
Objectives	Controls
<p>O1 To protect buildings, fences, works, relics, or places of heritage significance which form part of, or which are in the vicinity of an educational establishment.</p>	<p>C1 The location and design of development does not detract from a heritage item.</p> <p>C2 Siting of new development:</p> <ul style="list-style-type: none"> <li>a) when viewed from the public domain—preserves existing views to and from the heritage item.</li> <li>b) when viewed from surrounding residences—enables a sharing of views to and from the heritage item.</li> </ul> <p>C3 Fences that have heritage significance are conserved. Development in the vicinity of these fences responds to the heritage significance with a sympathetic design and finish.</p>
<p>O2 To ensure that new development is sympathetic to the heritage significance of heritage items and, where applicable, is sensitive to the streetscape qualities of heritage conservation areas.</p>	<p>C4 Development responds sympathetically to the heritage significance of items and heritage conservation areas in terms of architectural style and design, colours, materials, proportions and scale.</p>

## F2.5 Open spaces

Open playing fields and playgrounds provide attractive aspects onto and through educational establishments. Where physical access is provided to the public, the open space is a valuable shared community asset. Even when the facility cannot be publicly accessed, these spaces can be important contributors to the quality of the public and private domain.

Note: Section 2.1.7 of this chapter specifies definitions for “open space” “playgrounds” and “sportsfields”.

F2.5 Open spaces	
Objectives	Controls
<p>O1 To protect and retain existing open spaces.</p>	<p>C1 Existing open spaces are retained.</p>
	<p>C2 Vehicle access and parking is not permitted on any part of the site considered as open space.</p>
<p>O2 To ensure that educational establishments provide adequate open spaces to cater for the active and passive needs of students.</p>	<p>C3 New educational establishments and major development of existing establishments provide open spaces and maximise the use of existing open spaces, having regard to an overall plan for the siting, amenity impacts, usability and accessibility of such spaces.</p>
	<p>C4 Playgrounds are provided on site.</p>
	<p>C5 Sports fields are provided on site, where possible.</p>

## F2.6 Traffic, parking and access

Educational establishments require an efficient circulation network to manage the safety of students and staff, whilst ensuring that ongoing operations have minimal impacts on the amenity of the surrounding community.

To minimise impacts on the adjoining community, all parking, servicing and pick up/drop of arrangements should be provided on-site. The on-site parking requirements are identified in Part E of this DCP, Chapter E1 Parking and Access.

A traffic report is required to justify any variation to these requirements. In particular, the report should put forward alternative solutions, and address matters such as the requirements for parking generated by staff and students having regard to the location of the educational establishment, its catchment, proximity to public transport, and public transport use rates.

Staff and students are also encouraged to increase the proportion of journeys made by walking, cycling, public transport and car sharing. This will reduce the impact of the school journey on local road congestion.

F2.6 Traffic, parking and access	
Objectives	Controls
O1 To require efficient and effective road and pedestrian circulation networks.	<p>C1 The educational establishment does not unreasonably impact on the surrounding road network, specifically in relation to pedestrian safety and vehicle traffic.</p> <p>Note: A traffic and pedestrian management plan may be required to demonstrate impacts.</p>
O2 To minimise conflict between vehicles and pedestrians, particularly at entrances.	<p>C2 Pedestrian access is provided to all frontages that adjoin the public domain.</p> <p>C3 Pedestrian access is segregated from vehicular access with clearly defined paths.</p> <p>C4 Equitable access is provided in accordance with Part E of this DCP, Chapter E1 Parking and Access.</p>

F2.6 Traffic, parking and access	
Objectives	Controls
<p>O3 To minimise the impact on the surrounding community due to the arrival and departure of students.</p>	<p>C5 Pedestrian areas are at key entry points to accommodate concentrations of pedestrians, e.g. pick up time.</p> <p>C6 For a new educational establishment or major development of an existing establishment—an internal driveway for vehicles is provided for picking-up and dropping-off students.</p>
<p>O4 To minimise demand for on-street parking.</p> <p>O5 To provide adequate on-site parking for staff, visitors, disabled persons, delivery, service, emergency vehicles, and tertiary students.</p>	<p>C7 Development complies with the parking requirements in Part E of this DCP, Chapter E1 Parking and Access.</p> <p>C8 Provision is made on-site for service and emergency vehicles.</p>
<p>O6 To encourage use of bicycles as a means of travel to educational establishments.</p>	<p>C9 Bicycle parking is provided.</p> <p>C10 For secondary and tertiary establishments—dedicated secure bicycle parking is provided at the following rates:                      a) 5% of staff numbers<sup>1</sup>;                      b) 10% of full time student numbers;                      at a central location and with associated change rooms and showers.</p>

Note: Major proposals are to provide a Traffic and Pedestrian Management Plan (TPMP). The TPMP is to identify potential impacts to the surrounding road network and to recommend a course of action to address potential impacts on pedestrian safety and vehicle traffic flow.

The TPMP is to be prepared by a suitably qualified traffic consultant. The report must address at a minimum:

- the age and number of students;
- measures to enhance pedestrian safety when entering or crossing roads;
- pedestrian desire lines;
- public buses, school buses and lay-by areas;

<sup>1</sup> Rates taken from the NSW Planning Guidelines for Walking and Cycling, December 2004

- ▶ measures to encourage the use of sustainable means of transport (cycling, walking and public transport);
- ▶ strategies to discourage students from driving to school;
- ▶ strategies to minimise the impact of students arriving and departing (such as staggering school start and finish times;
- ▶ the numbers and type of vehicles used to transport students to and from school;
- ▶ an analysis of the surrounding road network and other key traffic generating locations;
- ▶ provision of drop off/pick up areas on site; and
- ▶ parking (see Part E of this DCP, Chapter E1 Parking and Access).

## F2.7 Planting, fencing and hard surfaces

Educational establishments have unique requirements for planting, fencing and hard surfaces. These elements are used to define spaces and activities, soften the built form and facilitate views and vistas.

F2.7 Planting, fencing and hard surfaces	
Objectives	Controls
O1 To conserve existing landscaping which contributes to the streetscape.	C1 Significant trees on the site are retained. C2 Development does not damage significant trees located on land adjoining the site.
O2 To promote a high standard of landscape design.	C3 Landscaping provides shade for play, screening of buildings, an improved microclimate, soil stabilisation, and visual quality. C4 The landscape design is coordinated with, or has suitable regard to: a) the local streetscape; b) site conditions; c) on-site building design and open spaces; and d) type, scale and location of adjoining development. C5 Existing vegetated areas which contribute to the public realm are retained. These areas include, but are not limited to: a) Kincoppal (foreshore bush land); b) Vaucluse Public School (open space adjacent to Cambridge Avenue); and c) Glenmore Public School (vegetated strip adjacent to Glenmore Road).



<b>F2.7 Planting, fencing and hard surfaces</b>			
<b>Objectives</b>		<b>Controls</b>	
O3	To encourage planting and fencing which enables open spaces and existing vistas and views to contribute to the public domain.	C6	Planting or fencing does not block significant views or open spaces from adjacent public domain or private property.
		C7	At least 50% of fencing is open to facilitate views and vistas of open spaces from the public domain.
O4	To conserve fences and gates that have heritage significance.	C8	Refer to Section F2.4 Heritage conservation above.

## F2.8 Community use

Educational establishments provide important resources for the community, by supplying flexible spaces that can be used for a variety of purposes. However, the use of these areas by the wider community needs to be suitably managed and should not negatively impact on the amenity of the adjoining residents.

Depending on the community use, and its intensity and frequency, Council may require a plan of management to be submitted with the development application to demonstrate how potential impacts to adjacent properties and the surrounding area will be minimised.

The plan of management must identify the proposed operations and likely impacts, as well as the following issues: pedestrian and vehicular access, parking and servicing, lighting, noise and security and safety.

F2.8 Community use	
Objectives	Controls
<p>O1 To encourage use of school facilities by the wider community.</p>	<p>C1 Buildings are flexibly designed and capable of being used for a variety of purposes.</p> <p>C2 The design of the facility incorporates the principles of <i>Crime Prevention Through Environmental Design</i>.</p>
<p>O2 To minimise the adverse effects of community use of an educational establishment on the amenity of the adjacent properties.</p>	<p>C3 Lighting, noise, hours of operation, and intensity of use does not detrimentally impact on adjacent properties.</p> <p>C4 Pedestrian and vehicular access to the community use does not significantly impact on the surrounding road network.</p> <p>C5 Parking and servicing associated with the community use is accommodated on site, and does not unreasonably impact on the adjoining uses.</p> <p>Note: A plan of management is to be submitted with the DA identifying the proposed operations and likely impacts.</p>

# Chapter F3 Licensed Premises

Part F ▶ Land Use Specific Controls

CHAPTER F3 APPROVED ON 27 APRIL 2015  
AND COMMENCED ON 23 MAY 2015

Last amended on 31 May 2024



## Chapter F3 ▶ Licensed Premises

### Contents

<b>F3.1</b>	<b>INTRODUCTION .....</b>	<b>1</b>
	F3.1.1 Land and development where this chapter applies .....	2
	F3.1.2 Development to which this chapter applies .....	2
	F3.1.3 Objectives .....	3
	F3.1.4 Relationship to other parts of the DCP .....	3
	F3.1.5 Relationship to other documents.....	4
<b>F3.2</b>	<b>LICENSED PREMISES RISK RATING .....</b>	<b>5</b>
<b>F3.3</b>	<b>OBJECTIVES AND CONTROLS.....</b>	<b>6</b>



---

## F3.1 Introduction

Licensed premises continue to be a fundamental part of the social fabric of the community. These provide venues for social interaction and for entertainment for a large cross section of the community.

Licensed premises contribute to the night economy and the business community derives a broad range of benefits from the operation of venues, employment in hospitality, entertainment and tourist industries, the supply of food, drink and other related services. Licensed premises are venues for artistic expression for up-and-coming, as well as established, musicians and other artists.

While licensed premises can make positive contributions to society they can also be the source of neighbourhood disturbance and anti-social behaviour. This can take the form of noise and other nuisances but at its worst can lead to property damage, crime and violence (including violence towards emergency service workers). There are also significant associated health costs related to physical injuries and mental illness resulting from alcohol abuse.

The external impact of licensed premises on the community is essentially related to three risk factors:

- ▶ the type of licensed premises;
- ▶ the sensitivity of the locality within which it is, or is proposed to be, located; and
- ▶ the trading hours and number of patrons.

The measures which need to be applied to avoid unacceptable external impacts will be different depending on these factors. For instance, a pub in or adjacent to a residential area has the potential for greater external impacts than a small restaurant in a business area.

Therefore, based on the above three factors, this DCP adopts a risk rating approach, i.e. high risk or low risk, as a guide for establishing the appropriate response to proposals involving licensed premises.

There are controls in this chapter which relate directly and indirectly to the density of licensed premises in the consideration of development applications (DAs) and other related applications. This is because studies have demonstrated that there is a connection between areas with higher densities of licensed premises and increases in the incidence of alcohol-related anti-social behaviour.

The assessment of DAs and other related applications for licensed premises will include consideration of the density of existing licensed premises in the vicinity and any incidences of alcohol-related anti-social behaviour.

Situations may arise where it is not possible to support additional licensed premises in areas where high densities occur and where anti-social behaviour is causing unacceptable impacts on the surrounding community.

---

### F3.1.1 Land and development where this chapter applies

---

This chapter applies to all land within the Woollahra Municipality.

Woollahra Local Environmental Plan 2014 (Woollahra LEP 2014) sets out where various land uses (including the use of land for the purposes of licensed premises) are permissible, either with or without development consent, or whether they are prohibited.

Under Woollahra LEP 2014, licensed premises of some categories are permissible in a number of the land use zones. The land use zones provide an indication of an area's environmental amenity sensitivity.

### F3.1.2 Development to which this chapter applies

---

This chapter applies to all development proposals involving licensed premises.

Licensed premises are those premises which are licensed, or which require a licence to be issued, under the *Liquor Act 2007* (Liquor Act), Part 3, Division 1. The Liquor Act provides for various types of licences to be issued, as set out in Section 3.1.5 below.

This chapter of the DCP also applies to the following applications made under the *Environmental Planning and Assessment Act 1979* (EP&A Act):

- ▶ DAs for existing licensed premises;
- ▶ applications for the modification of development consents (s.96 applications);
- ▶ applications for the review of a determination of a DA (s.82A review); and
- ▶ reviewable conditions (s.80 (10B)).

In the Woollahra Municipality there are existing licensed premises located in zones where they are no longer permitted. These premises operate as existing uses and are subject to special provisions (see EP&A Act, Division Part 4, Division 10).

The controls in this chapter have been prepared to complement Council's procedure *Extension or Intensification of a Use* which relates to applying the Land and Environment Court Planning Principle for licensed premises established in *Vinson v Randwick Council [2005] NSWLEC 142*.

#### Where this DCP chapter does not apply

This chapter does not apply to the current operating conditions of existing licensed premises. Current operating conditions will only be considered where relevant to the determination of a DA. For example, a DA seeking the intensification of the current use such as extended trading hours or increased patron numbers.



---

### F3.1.3 Objectives

---

The objectives of this chapter are:

- O1 To standardise the way we assess DAs and other related applications for licensed premises.
- O2 To provide certainty to applicants, residents and other stakeholders regarding our approach to, and planning requirements for, dealing with DAs and other related applications for licensed premises.
- O3 To achieve a more consistent approach to determining trading hours and operating conditions for licensed premises.
- O4 To recognise the important role of licensed premises in contributing to the vitality and vibrancy of centres at night while minimising potential negative impacts from activities associated with licensed premises.
- O5 To provide for the safety of patrons and the general public.
- O6 To ensure noise from the activities of licensed premises is not intrusive and does not unreasonably impact on the amenity of adjoining and nearby residential uses.

Note: This chapter is not intended to duplicate processes under the Liquor Act. However, we reserve our right to make submissions, which may be in the nature of objections, in relation to:

- ▶ the preparation of a Community Impact Statement as part of a licence application under the Liquor Act; and
- ▶ a licence application, or the terms of a licence application, under the Liquor Act.

We reserve this right notwithstanding that we may have granted a development consent in relation to the use of the premises for the purposes of a licensed premises.

### F3.1.4 Relationship to other parts of the DCP

---

This chapter is to be read in conjunction with the other parts of the DCP that are relevant to the development proposal, including:

- ▶ If located in a residential area—the controls in Part B: General Residential, or Part C: Heritage Conservation Areas that apply to the land.
- ▶ If located in a business centre—the controls in Part D: Business Centres that apply to the land.
- ▶ Part E: General Controls for All Development - this part contains chapters on Parking and Access, Stormwater and Flood Risk Management, Tree Management, Contaminated Land, Waste Management, Sustainability, Signage and Adaptable Housing.

### F3.1.5 Relationship to other documents

#### *Liquor Act 2007*

The Liquor Act includes licensing provisions for the sale of alcohol which is based on the categorisation of licensed premises.

Matters to be considered before a licence can be issued under the Liquor Act are the social impacts of issuing a licence and whether the licensee would be a fit and proper person to hold a licence. If development consent is required under the EP&A Act for the use of premises, then proof that a consent is in force also needs to be provided.

The potential environmental risk associated with the different categories of licensed premises varies.

#### Types of licences under the *Liquor Act 2007*

Type of licence	Type of use or activity
Hotel (including a general bar licence)	Pub or large bar with more than 100 patrons
Club	Registered club
Small bar	Small bar with under 100 patrons
On-premises	Restaurant or cafe, nightclub, entertainment facility, hotel or motel accommodation, function centre and other venues where liquor is consumed on the premises
Packaged liquor	Bottle Shops or online liquor sales
Producer/wholesaler	Brewer, distiller, winemaker or wholesaler
Limited	Functions held by non-profit organisations, as well as special events and trade fairs

#### Woollahra Footway Dining Policy and Guidelines

The Footway Dining Policy and Guidelines establish Council's requirements for the use of footpaths for footway dining. These documents address a range of matters including maximum footway trading hours and requirements for pedestrian accessibility, safety and amenity.

### F3.2 Licensed premises risk rating

The following table shows the risk rating for licensed premises.

RISK RATING OF LICENSED PREMISES		
Type of licence	Location/zone	Risk rating
Hotel or General Bar, packaged liquor, clubs irrespective of their capacity	Anywhere	<b>HIGH</b>
On-premises, producer/wholesaler, limited with a capacity of 100 or more patrons		
Any licensed premises	R2 and R3 zones	<b>HIGH</b>
On-premises/small bars	E1	<b>HIGH</b>
	E1, MU1, SP3 and RE1	<b>LOW</b>
Small bars, on-premises, packaged liquor, producer/wholesaler, limited with a capacity of less than 100 patrons	E1	<b>LOW</b>
Note: Outdoor seating is included in calculating patron capacity		

### F3.3 Objectives and controls

Objectives	Controls
<p>O1 Minimise the impact of licensed premises on the amenity of residential or other sensitive land uses.</p>	<p>C1 Before deciding on an application involving licensed premises, the following matters are considered:</p> <ul style="list-style-type: none"> <li>a) the location of the premises and the proximity of residential and other sensitive uses, including any external areas (not fully enclosed areas);</li> <li>b) the type of licensed premises;</li> <li>c) the size and capacity of the premises;</li> <li>d) trading hours;</li> <li>e) existing and likely cumulative impacts, including social impacts, of licensed premises on the amenity of surrounding areas;</li> <li>f) existing and proposed management practices relating to the operation of the premises and of the areas in the vicinity of the premises;</li> <li>g) the density of licensed premises in the vicinity of the proposed development;</li> <li>h) availability of car parking and proximity and access to public transport; and</li> <li>i) any recommendations/comments provided by NSW Police (applications involving licensed premises will be referred to NSW Police for comment in accordance with our Memorandum of Understanding - Crime Prevention Through Environmental Design).</li> </ul>

Objectives		Controls			
O2	Identify appropriate trading hours for licensed premises	C2	The trading hours for licensed premises are as set out in the following table:		
<b>Trading Hours - Development within the site*</b>					
Risk rating	Internal (fully enclosed)		External (not fully enclosed)		
	Base	Extended	Base	Extended	
High	8am - 10pm	8am - midnight	7am - 10pm	7am - 11pm Fri and Sat only	
Low	8am - midnight	8am - 2am	7am - 10pm	7am - 11pm Fri and Sat only	
*Refer to the Woollahra Footway Dining Policy and Guidelines for the trading hours applicable to the use of footways for restaurant purposes.					
Note:	The base and extended trading hours referred to in the above table are not an ‘as of right’. Where licensed premises are located in close proximity to low density residential zones, Council may impose more restrictive trading hours than those shown in the table.	C3	Consents for licensed premises will, by condition, limit trading hours so that they do not exceed the base trading hours as shown in the Trading Hours Table under C2 (consents may impose trading hours less than the base trading hours).		
		C4	Extended trading hours may be permitted. The matters set out in C1 will be considered in the assessment of an application to extend trading hours. If approved, extending trading hours: <ul style="list-style-type: none"> <li>a) will not exceed the extended trading hours in the Trading Hours Table under C2 (an approval may be subject to a condition which requires extended trading hours to be less than the hours shown in the table); and</li> <li>b) will be approved as a reviewable condition under s.80A (10b) of the EP&amp;A Act.</li> </ul> Reviews of extended trading hours will only be undertaken if: <ul style="list-style-type: none"> <li>a) Council has satisfactory evidence to suggest the extended trading hours are unduly impacting on the amenity of the neighbourhood; or</li> <li>b) NSW Police has requested a review.</li> </ul>		

Objectives	Controls
<p>O3 Identify the maximum number of persons permitted on the licensed premises (including outdoor areas) to:</p> <ul style="list-style-type: none"> <li>a) minimise the impact on the amenity of surrounding residential and sensitive land uses; and</li> <li>b) provide a safe environment for occupants.</li> </ul>	<p>C5 Consents for licensed premises will, by condition, limit the maximum number of persons permitted on licensed premises based on:</p> <ul style="list-style-type: none"> <li>a) an assessment of likely amenity impacts; and</li> <li>b) fire safety and other emergency situation considerations.</li> </ul> <p>C6 An increase in the maximum number of persons permitted on licensed premises may be permitted. Under no circumstances will an increase be permitted if the number of persons would exceed fire safety/emergency criteria.</p> <p>An increase in the maximum number of persons permitted on licensed premises will be approved as a reviewable condition under s.80A (10b) of the EP&amp;A Act.</p> <p>Reviews of an increase in the maximum number of persons on licensed premises will only be undertaken if:</p> <ul style="list-style-type: none"> <li>a) Council has satisfactory evidence to suggest the increased number of persons are unduly impacting on the amenity of the neighbourhood; or</li> <li>b) NSW Police has requested a review.</li> </ul> <p>In these cases, reviews will be only be undertaken at the following intervals:</p> <ul style="list-style-type: none"> <li>▶ one year after the increased number of persons permitted on the licensed premises commence; or</li> <li>▶ two years after the first review, if that review does not result in a change to the increased number of persons permitted on the licensed premises; or</li> <li>▶ five years after the second or any subsequent review, if that second or subsequent review does not result in a change to the increased number of persons permitted on the licensed premises.</li> </ul>

Objectives	Controls
<p>O4 Appropriate management practices are implemented for licensed premises to:</p> <ul style="list-style-type: none"> <li>a) minimise impacts, such as anti-social behaviour and crime, on surrounding residential and other sensitive land uses particularly at closing times and during periods of high patronage; and</li> <li>b) safeguard persons occupying licensed premises.</li> </ul>	<p>C7 DAs for licensed premises are accompanied by:</p> <ul style="list-style-type: none"> <li>a) a management plan (see DA Guide - Management Plan for Licensed Premises, for information to be included in a management plan) which contains appropriate management practices having regard to the risk rating of the premises.</li> <li>b) a social impact report (see DA Guide - Social Impact Report for Licensed Premises, for information to be included in a social impact report) which contains an appropriate level of information of social impacts having regard to the risk rating of the premises.</li> </ul> <p>C8 Provision is made for suitable active and passive surveillance of the premises and its surrounds, e.g. security personal and CCTV cameras.</p> <p>C9 Revised management plans and social impact reports are submitted:</p> <ul style="list-style-type: none"> <li>a) for an application to extend trading hours;</li> <li>b) for an application to increase the maximum number of persons permitted in a building; and</li> <li>c) as part of review of condition that permits an extension of trading hours and/or that permits an increase in the number of persons permitted in a building.</li> </ul>

Objectives	Controls
<p>O5 Buildings and areas accommodating licensed premises are designed and located to:</p> <ul style="list-style-type: none"> <li>a) minimise impacts on the amenity of surrounding residential and other sensitive uses; and</li> <li>b) provide a safe environment for its occupants.</li> </ul>	<p>C10 The location of:</p> <ul style="list-style-type: none"> <li>a) outdoor areas of licensed premises (includes smoking areas);</li> <li>b) window, door and other openings in external walls;</li> <li>c) plant and equipment; and</li> <li>d) waste collection and storage areas</li> </ul> <p>is to take into account the proximity of residential and other sensitive uses.</p> <p>C11 A report by an acoustic engineer is submitted with applications involving licensed premises, where relevant.</p> <p>C12 Consideration will be given to upgrading fire services, building structure, toilet facilities, etc. of existing buildings where applications involving licensed premises result in a change of use and/or an intensification of use of the building.</p> <p>C13 Lighting is installed to enable visibility of activities and surveillance of the frontage, entrances and exits of licensed premises.</p> <p>C14 The frontage of a licensed premises is active and in keeping with the streetscape. Blank facades are avoided.</p>



# Chapter F4 Telecommunications

Part F ► Land Use Specific Controls

CHAPTER F4 APPROVED ON 27 APRIL 2015  
AND COMMENCED ON 23 MAY 2015



## Chapter F4 ▶ Telecommunications

### Contents

<b>F4.1</b>	<b>INTRODUCTION .....</b>	<b>1</b>
	F4.1.1 Background .....	1
	F4.1.2 Land where this chapter applies .....	1
	F4.1.3 Development to which this chapter applies .....	1
	F4.1.4 Objectives .....	2
	F4.1.5 Relationship to other parts of the DCP .....	2
	F4.1.6 Relationship with other documents .....	2
<b>F4.2</b>	<b>LOCATION AND DESIGN OF TELECOMMUNICATION FACILITIES .....</b>	<b>5</b>



## F4.1 Introduction

### F4.1.1 Background

---

The regulation of telecommunications infrastructure is primarily the responsibility of the Commonwealth and State Government, leaving little scope for Council to include additional requirements.

The key provisions are established in:

- ▶ *Commonwealth Telecommunications (Low-impact Facilities) Determination 1997* (LIF Determination); and
- ▶ *New South Wales (NSW) State Environmental Planning Policy (Infrastructure) 2007* (Infrastructure SEPP).

Between the LIF Determination and the Infrastructure SEPP, most types of telecommunication facilities are identified as development that does not require approval from Council. Generally the telecommunications carrier is only required to notify Council of the proposal and invite Council's comment.

For development that requires Council's consent, the State Government has published the *NSW Telecommunication Facilities Guideline including Broadband 2010* (NSW Telecommunications Guideline). This Guideline is the main control document for ensuring that telecommunications infrastructure is suitably located and designed in NSW, and its consideration in the assessment process is mandatory.

The Guideline addresses matters that Council would ordinarily consider for including in a DCP. To that end, this chapter of the DCP calls up the Guideline as Council's control document.

### F4.1.2 Land where this chapter applies

---

This chapter applies to all land within the Woollahra Municipality.

### F4.1.3 Development to which this chapter applies

---

#### Development requiring consent

This chapter applies to development for telecommunications facilities that require consent under clause 115 of *State Environmental Planning Policy (Infrastructure) 2007* (Infrastructure SEPP). Development under this clause must address the NSW Telecommunications Guideline as well as the objectives and controls in this chapter of the DCP.

Note: Under the Infrastructure SEPP telecommunication facilities are permitted in any zone. Woollahra Local Environmental Plan 2014 does not specifically list "telecommunications facilities" in the land use tables to avoid duplicating the Commonwealth and State planning controls.

---

### Other development for which Council is notified

Most telecommunications infrastructure can be undertaken without Council's consent. Notwithstanding, the telecommunications carrier is generally required to notify Council of its intention to undertake the development, and to seek Council's comment. The provisions in this chapter will inform Council's response to these notices.

Under the LIF Determination, Council will be notified of mobile phone base station development<sup>1</sup>.

Under the Infrastructure SEPP, Council will be notified of the following types of development:

- ▶ development that does not require consent under clause 114, which Council is notified of under subclause 114(2);
- ▶ exempt development under clause 116<sup>1</sup>; and
- ▶ complying development under clause 116A<sup>1</sup>.

### F4.1.4 Objectives

---

The provisions in this part of the DCP recognise that the NSW Telecommunications Guideline is Council's policy for assessing telecommunications facilities that require consent.

### F4.1.5 Relationship to other parts of the DCP

---

This chapter is to be read in conjunction with the other parts of the DCP that are relevant to the development proposal, including:

- ▶ If located in a residential area—the controls in Part B: General Residential, or Part C: Heritage Conservation Areas that apply to the land.
- ▶ If located in a business centre—the controls in Part D: Business Centres that apply to the land.

### F4.1.6 Relationship with other documents

---

The following documents should be read in conjunction with this chapter of the DCP.

#### *Telecommunications Act 1997 and Radiocommunications Act 1992*

The *Telecommunications Act 1997* establishes a regime for carriers' rights and responsibilities when installing, inspecting or maintaining telecommunications facilities.

The *Radiocommunications Act 1992* regulates radiocommunications transmitters. It provides for the licensing of radiocommunications equipment and applies mandatory standards to its use.

---

<sup>1</sup> This is a requirement to notify in relation to mobile phone base station development, and is established under clauses 5.1.1 and 6.4 of the Industry Code.

---

### ***Telecommunications Code of Practice 1997***

The *Telecommunications Code of Practice 1997* establishes obligations on carriers in land access situations such as when inspecting land, installing low-impact facilities and maintaining facilities. It also requires carriers to comply with recognised industry codes and standards.

### ***Telecommunications (Low-impact Facilities) Determination 1997***

The LIF Determination applies to many types of telecommunications infrastructure, and allows these to be constructed without Council's approval.

These low-impact facilities are restricted to certain sizes, structures and locations. For example, a mobile phone antenna is not to protrude from a structure by more than 3m, and the diameter of a satellite dish is to be a maximum of 1.2m.

Development on a site containing a heritage item, or located in a heritage conservation area, cannot be a low-impact facility. Low-impact facilities also do not include development that is a tower that is not attached to a building, a tower attached to a building and more than 5m high, or an extension to a tower that has previously been extended.

### ***State Environmental Planning Policy (Infrastructure) SEPP 2007 and the NSW Telecommunications Facilities Guideline including Broadband 2010***

The Infrastructure SEPP provides a planning regime for infrastructure and the provision of services across NSW. Division 21 of the Infrastructure SEPP addresses telecommunications facilities development.

Depending on the location and scope of works, the Infrastructure SEPP permits telecommunications facilities within NSW as:

- ▶ exempt development;
- ▶ complying development;
- ▶ development with consent; and
- ▶ development that does not require consent.

To support the SEPP, the Department of Planning and Infrastructure introduced the NSW Telecommunications Guideline in 2010. The NSW Telecommunications Guideline establishes the planning controls for telecommunications facilities permitted under the Infrastructure SEPP.

In particular, Part 2.2 of the Guideline contains principles regarding the site selection, design, construction and operation of telecommunications facilities. Development that requires consent under clause 115 of the Infrastructure SEPP must have regard to these principles, therefore these have not been duplicated in this chapter.

**Industry Code C564:2011 Mobile Phone Base Station Deployment 2011**

The Industry Code adopts a precautionary approach to the location and design of telecommunications facilities. It also outlines telecommunications carriers' responsibilities regarding consultation; this includes requirements for notifying Council and relevant parties of any proposed mobile phone telecommunications facilities that do not require Council consent, such as low-impact facilities permissible under the LIF Determination.

For development that Council is notified of, this DCP is to be considered by the telecommunications carriers as it will form the basis of Council's comments on the proposed development.



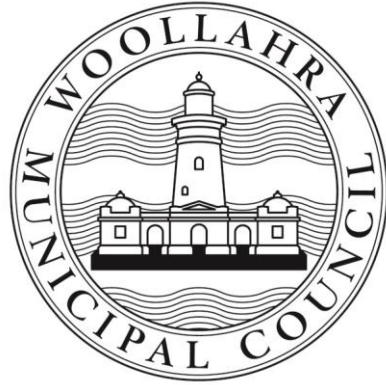
## F4.2 Location and design of telecommunication facilities

The site selection, design, construction and operation of telecommunication facilities in NSW if carried out under clause 114 or 115 of the Infrastructure SEPP must be consistent with the principles set out in the NSW Telecommunications Guideline.

The principles are:

- ▶ Principle 1: A telecommunications facility is to be designed and sited to minimise visual impact.
- ▶ Principle 2: Telecommunications facilities should be co-located wherever practical.
- ▶ Principle 3: Health standards for exposure to radio emissions will be met.
- ▶ Principle 4: Minimise disturbance and risk, and maximise compliance.

Objectives	Controls
O1 To ensure that telecommunications facilities have minimal impact on the amenity of an area.	C1 The provisions in the NSW Telecommunications Guideline apply.



## Part G ► Site-Specific Controls

WOOLLAHRA DEVELOPMENT CONTROL PLAN 2015



# Chapter G1

## Babworth House, Darling Point

Part G ► Site-Specific Controls

CHAPTER G1 APPROVED ON 27 APRIL 2015  
AND COMMENCED ON 23 MAY 2015



# Chapter G1 ► Babworth House, Darling Point

## Contents

<b>G1.1</b>	<b>INTRODUCTION .....</b>	<b>1</b>
	G1.1.1 Background.....	1
	G1.1.2 Land where this chapter applies .....	1
	G1.1.3 Development to which this chapter applies.....	2
	G1.1.4 Objectives.....	2
	G1.1.5 Relationship to other parts of the DCP .....	2
	G1.1.6 Relationship to other documents .....	2
<b>G1.2</b>	<b>PLANNING PRINCIPLES .....</b>	<b>3</b>
<b>G1.3</b>	<b>CHARACTER STATEMENTS .....</b>	<b>4</b>
	G1.3.1 Character elements .....	4
	G1.3.2 Desired future character objectives.....	4
<b>G1.4</b>	<b>DESIGN CRITERIA .....</b>	<b>5</b>
	G1.4.1 Masterplan .....	5
	G1.4.2 Heritage conservation.....	8
	G1.4.3 Site layout.....	14
	G1.4.4 Building envelope .....	19
	G1.4.5 Design elements, roof form and building materials .....	32
	G1.4.6 Landscape, open space .....	34
	G1.4.7 Acoustic and visual privacy .....	37
	G1.4.8 Access and mobility .....	38
	G1.4.9 Car parking and servicing.....	41
	G1.4.10 Site facilities .....	45
	G1.4.11 Energy efficiency .....	46
	G1.4.12 Water and soil management.....	48
	G1.4.13 Safety and surveillance.....	50
	G1.4.14 Subdivision, maintenance and management .....	51



## G1.1 Introduction

### G1.1.1 Background

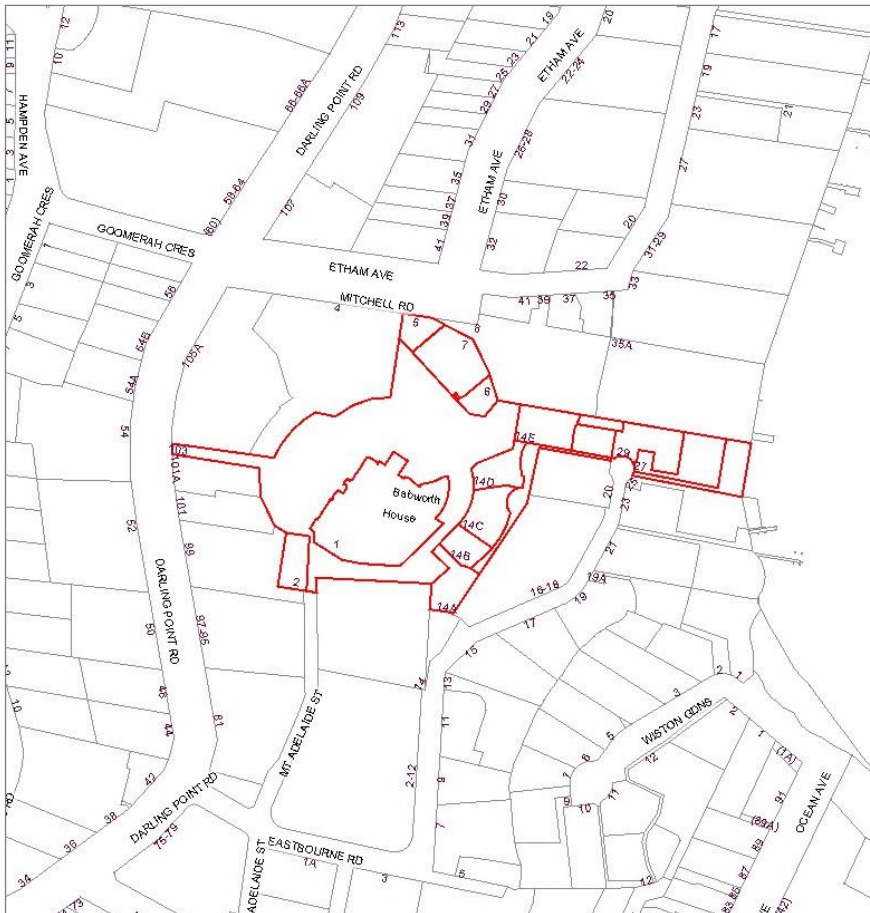
This chapter provides detailed controls for development on the Babworth House site and seeks to ensure the conservation of Babworth House, significant cultural landscape features and out-buildings.

Note: This chapter reflects the site specific development control plan adopted by Council on 15 June 1999, and which commenced on 19 November 1999.

### G1.1.2 Land where this chapter applies

This chapter applies to land at 103 Darling Point Road, Darling Point (Lots 1-5 SP 70612 and Lots 4, 5, 6, 7, 10, 11, 12, 13, 14, 16 and 17 DP 270253) commonly known as ‘Babworth House’, as identified in Figure 1.

**FIGURE 1** Where this chapter applies





---

### G1.1.3 Development to which this chapter applies

---

This chapter applies to development requiring consent under Woollahra Local Environmental Plan 2014 (Woollahra LEP 2014).

### G1.1.4 Objectives

---

The objectives of this chapter are:

- O1 To maintain the cultural (heritage significance of Babworth House in the context of its cultural landscape setting.
- O2 To retain the principal heritage and cultural landscape features of the site.
- O3 To facilitate appropriate development of the site and uses within Babworth House.

### G1.1.5 Relationship to other parts of the DCP

---

This chapter is to be read in conjunction with the other parts of the DCP that are relevant to the development proposal, including:

- ▶ Part B: Chapter B1 Residential Precincts (Darling Point)
- ▶ Part B: Chapter B3 General Development Controls
- ▶ Part E: General Controls for All Development - this part contains chapters on Parking and Access, Stormwater and Flood Risk Management, Tree Management, Contaminated Land, Waste Management, Sustainability, Signage and Adaptable Housing.

In the event of any inconsistency between this chapter and the other chapters, this chapter prevails.

### G1.1.6 Relationship to other documents

---

#### Conservation Management Plan

Applicants must refer to any conservation management plans prepared for the site.

## G1.2 Planning principles

The planning principles for the Babworth House site are:

- a) To ensure that future development of the site is carried out in accordance with sound planning, cultural and heritage principles, whilst taking into account the community's response.
- b) To undertake consultation with the community as part of the development application assessment process.
- c) To protect the cultural significance of the site and Babworth House.
- d) To ensure conservation of the historic buildings and the grounds to maintain an appropriate visual setting for Babworth House.
- e) To protect views to, from and over the site.
- f) To retain existing principal views from Babworth House.
- g) To prevent high or medium rise towers on the site.
- h) To preserve all significant trees or vegetation on the site.
- i) To provide adequate privacy and solar access to adjoining properties.
- j) To ensure that any new building or structure employs a design idiom, scale, massing, materials, details and construction techniques which provide an appropriate response to the cultural significance of Babworth House and its landscape setting.
- k) To allow for public pedestrian access to the foreshore.
- l) To minimise traffic impacts by providing multiple vehicular access points.
- m) To ensure the ongoing care and maintenance of the historic buildings (Babworth House and garage) and grounds.
- n) To encourage retention of a single management structure for the site.
- o) To retain the outer subdivision boundaries of the site.

These planning principles form the basis of the objectives and detailed provisions in this chapter.

## G1.3 Character statements

The character elements represent the distinguishing and important features of the site. Any future development on the site is to retain these elements and must meet the desired future character objectives.

The character elements and desired future character objectives set the context for development on the site.

### G1.3.1 Character elements

The character elements of the site are:

- a) Babworth House is one of the largest, finest and most intact examples of an early twentieth century grand house in Australia with Federation Arts and Crafts styles. This style incorporates both Art Nouveau and Neoclassical motifs. Babworth House displays high quality finishes and detailing.
- b) The strong emphasis on the location of Babworth House within a landscaped setting and on the highest point of Darling Point. The location of the site and Babworth House provides commanding views to, from and over the site.
- c) The historic link between Babworth House and Darling Point Road, and the historic and significant landscape link between the house and Double Bay.

### G1.3.2 Desired future character objectives

The desired future character objectives for the site are:

- O1 To retain and readily interpret the cultural (heritage) significance of Babworth House and its landscaped setting.
- O2 To maintain and enhance a visual landscaped linkage with Double Bay and the historic pedestrian link with Darling Point Road.
- O3 To maintain the 'grand estate' character of the site.
- O4 To ensure that the location, height and bulk of new buildings retain the existing significant views from Babworth House.
- O5 To ensure that the location, height and bulk of new buildings retain views of Babworth House from the harbour.

## G1.4 Design criteria

The design criteria are divided into particular design elements. Each element includes objectives and controls. Meeting the controls may satisfy the objectives of each design element.

### G1.4.1 Masterplan

A masterplan sets out:

- ▶ details on the design of buildings and the method of building construction
- ▶ a plan for integrated development for the site as a whole
- ▶ the arrangement, location, footprint and envelopes of buildings and their relationship with Babworth House, site features, adjoining development, existing landscape and access arrangements
- ▶ the intended uses of all buildings.

#### Objectives

- O1 To provide a planning framework for the site as a whole.
- O2 To prevent fragmented development of the site.

#### Controls

- C1 A masterplan is prepared for the whole of the site.
- C2 All development is consistent with the adopted Conservation Management Plan for the site.
- C3 In preparing the masterplan the applicant undertakes and submits to Council a site analysis, which takes into consideration:
  - a) site dimensions;
  - b) site configuration;
  - c) hydrology - overland and sub-surface water flows;
  - d) topography - including soil condition and stability;
  - e) the structural condition of the right-of-way over 4 Mitchell Road and its ability to carry vehicles;
  - f) services;
  - g) easements;
  - h) existing vegetation (location, spread, height and species) and other landscape features;
  - i) micro climate (e.g. orientation and prevailing winds);
  - j) location of Babworth House, significant spaces and elements;
  - k) adjoining development;

- 
- l) the heritage significance of the buildings and elements on the site and on adjoining land, and their respective settings;
  - m) form, scale, colour, texture and materials of heritage listed buildings and hard landscape elements (e.g. paths, balustrades) that are located on the site;
  - n) potential archaeological zoning;
  - o) views to, from and over the site;
  - p) pedestrian and vehicular access or linkages with surrounding areas;
  - q) form, height, scale and type of surrounding development;
  - r) overshadowing of existing buildings;
  - s) other opportunities and constraints to development; and
  - t) opportunities for public access to and along the foreshore.

Note: The above information is the minimum information required for the site analysis. Council may require other information to be provided. Information is to be shown on a survey plan at a scale of 1:250.

C4 The masterplan:

- a) demonstrates compliance with the objectives of this chapter;
- b) details by distinct survey reference the arrangement, location, footprint and envelopes of buildings and their relationship with Babworth House, site features, adjoining development, existing landscape and access arrangements;
- c) identifies the impact of construction of any proposed development on the culturally significant fabric of Babworth House and its setting;
- d) identifies the intended uses of all buildings or spaces;
- e) details the proposed use and subdivision of Babworth House;
- f) identifies private and communal open space areas and facilities;
- g) delineates the private and communal open space areas;
- h) identifies all accessways/paths and their role in providing connections for pedestrian access within and beyond the site;
- i) specifies where and how public access is to be provided to and along the harbour foreshore area;
- j) specifies vehicular access, parking, security and servicing arrangements;
- k) addresses ways to achieve energy efficiency;
- l) details the staging (if any) of the development;
- m) details the proposed method of subdivision and notional plan of subdivision;
- n) addresses other relevant design aspects and issues identified by Council during pre-DA discussions;

- o) Is accompanied by:
- a Statement of Heritage Impact (see Section 1.4.2)
  - an Archaeological Assessment (see Section 1.4.2)
  - a Landscape Concept Plan (including an arborist's report) and Landscape Management Plan (see Section 1.4.6)
  - an energy efficiency report, if required (see Section 1.4.11)
  - a Stormwater And Soil Management Plan (see Section 1.4.12)
  - a geotechnical report
  - a hydrology report
  - a statement of environmental effects
  - shadow diagrams for all new buildings
  - photomontages of new buildings within their settings
  - a detailed statement on the method of construction for all new buildings, particularly the proposed construction of foundations
  - a report on the structural condition of the right-of-way which is to include any limitations to its existing and future use due to that condition
  - any other information identified by Council during pre-DA discussions.

---

## G1.4.2 Heritage conservation

---

Babworth House, its garden and landscape setting is of national significance and should be retained and conserved.

Conserving the cultural significance of Babworth House and grounds is one of the principal objectives of this chapter.

Conservation is defined in the Australia ICOMOS Burra Charter as all the processes of looking after a place so as to retain its cultural significance. It includes maintenance and may, according to circumstances, include preservation, restoration, reconstruction and adaptation and will be commonly a combination of more than one of these.

### Objectives

- O1 To protect and enhance the cultural significance of Babworth House and its setting, including spaces or elements that are of special architectural, social, technical and/or historical interest.
- O2 To preserve archaeologically significant artefacts and evidence.

### Controls

- C1 Babworth House, its garden structures and landscape setting is retained and conserved in accordance with the policies of the adopted Conservation Management Plan.
- C2 The use of Babworth House and Garage:
  - a) is consistent with the policies of the adopted Conservation Management Plan;
  - b) is in accordance with the graded zones of significance for the House and Garage (see Figures 2A-C and 3);
  - c) contributes to the preservation and enhancement of the House, Garage and grounds (see Figure 4 - 1 and 1b landscaped zones of significance); and
  - d) is carried out without danger to the fabric and structure of the building.
- C3 New buildings and structures are located only within the areas graded 1c under the adopted Conservation Management Plan (see Figure 4) and comply with the building envelope controls in Section 1.4.4.

All building envelopes are to be taken as indicative. Provisions of the *Environmental Planning and Assessment Act 1979* and statutory provisions within environmental planning instruments which apply to the land together with the planning principles, objectives and controls mentioned in this chapter are to take precedence over the conceptual building layout (Figure 8) and the building envelopes.

Council may require deletion or modification of building envelopes or buildings if development is considered by the Council to be unsatisfactory in terms of the relevant provisions of the Act, the environmental planning instruments, planning principles, objectives and controls.

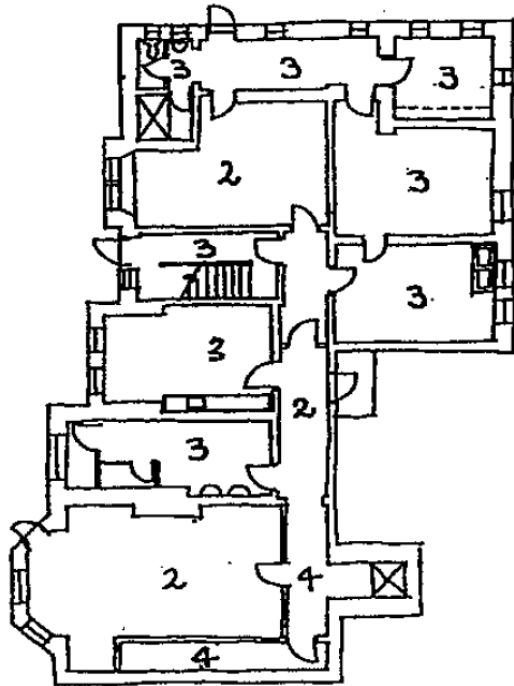
- 
- C4 The scale of new development is substantially subservient to Babworth House and must respect and must not compromise the conservation of significant garden fabric and layout or the setting of the house.
- C5 New development incorporates design elements that complement, but do not mimic the architectural character of Babworth House through:
- a) a design idiom that is an appropriate response to the cultural significance of Babworth House and its setting;
  - b) subservient massing, scale and height;
  - c) roof forms;
  - d) proportion and relationship of openings for windows and doors;
  - e) building materials; and
  - f) appropriate landscaping relative to the restoration plan for the garden.
- C6 A Statement of Heritage Impact, prepared by a suitably qualified person, accompanies the masterplan application. Further statements for detailed development applications are provided. The statements set out the cultural (heritage) significance of the place as a whole and the relevant significant spaces or elements, and the effect of the proposed works on this significance. The statements include discussion on the rationale for the character and scale of the proposed new structures within the Babworth House site.
- C7 An Archaeological Assessment, prepared by a suitably qualified person, accompanies development applications and is in accordance with the findings of the Archaeological Zoning Plan<sup>1</sup> (refer Figure 5). An Archaeological Assessment includes specific recommendations which address the significance of the site, the impact of the proposal and proposed conservation or mitigation measures.

---

<sup>1</sup> The archaeological zoning plan graphic plan of a place indicating the relative archaeological potential of areas or zones within the place.



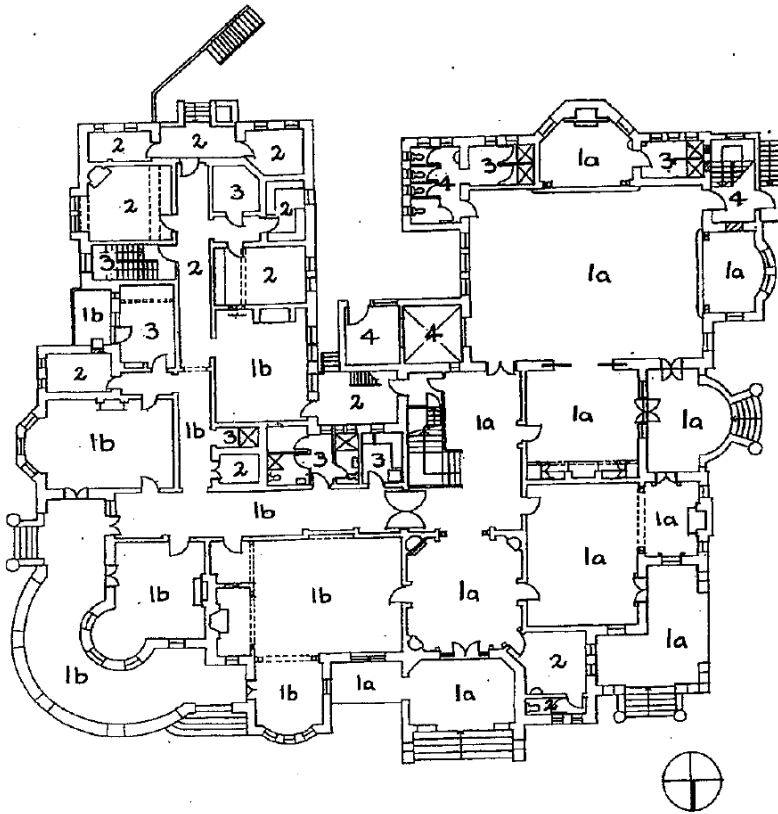
**FIGURE 2A** Babworth House (basement) - graded zones of significance



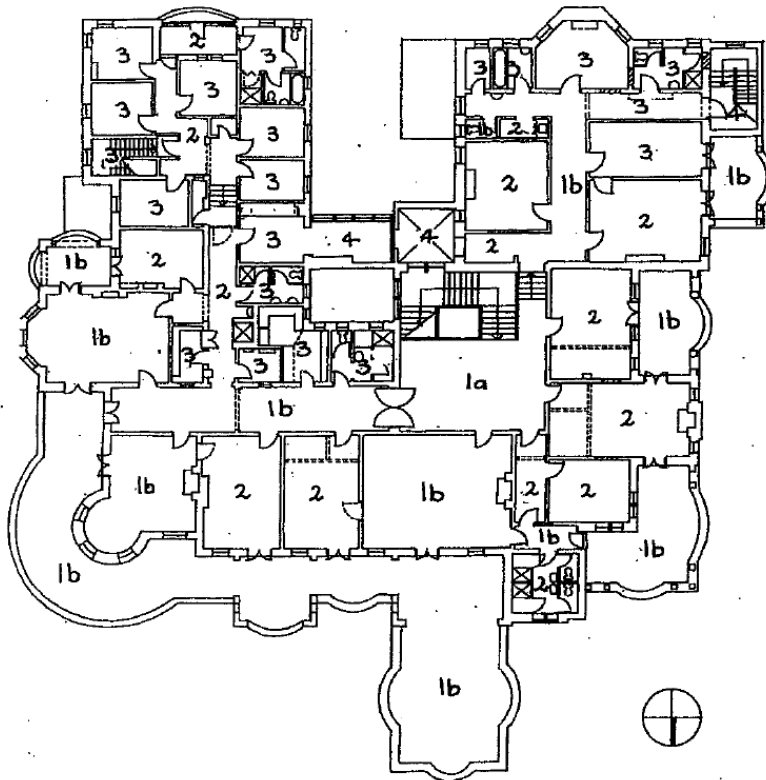
**LEVELS OF SIGNIFICANCE**

- 1a Very high significance
- 1b High significance
- 2 Medium significance
- 3 Low significance
- 4 Intrusive

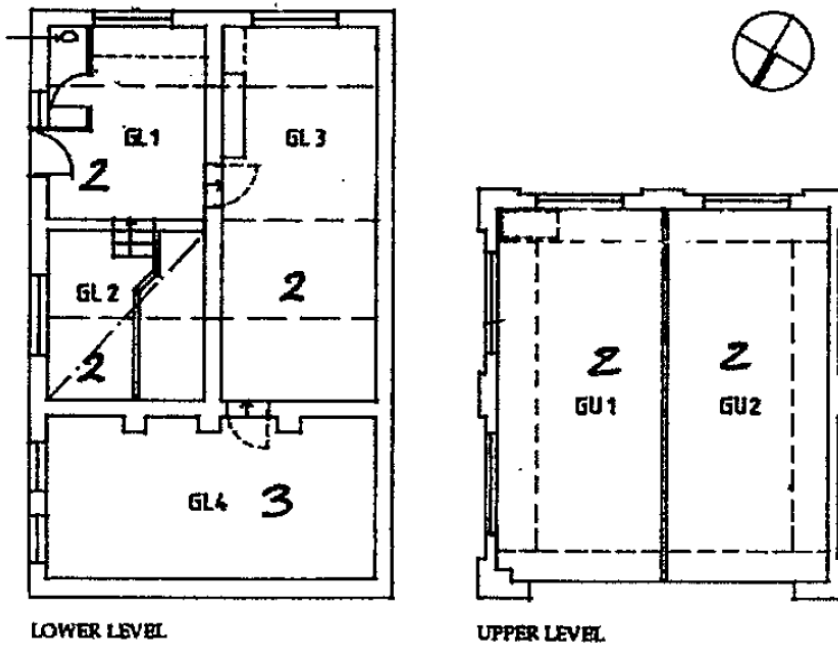
**FIGURE 2B** Babworth House (ground floor) - graded zones of significance



**FIGURE 2C** Babworth House (first floor) - graded zones of significance



**FIGURE 3** Garage - graded zones of significance



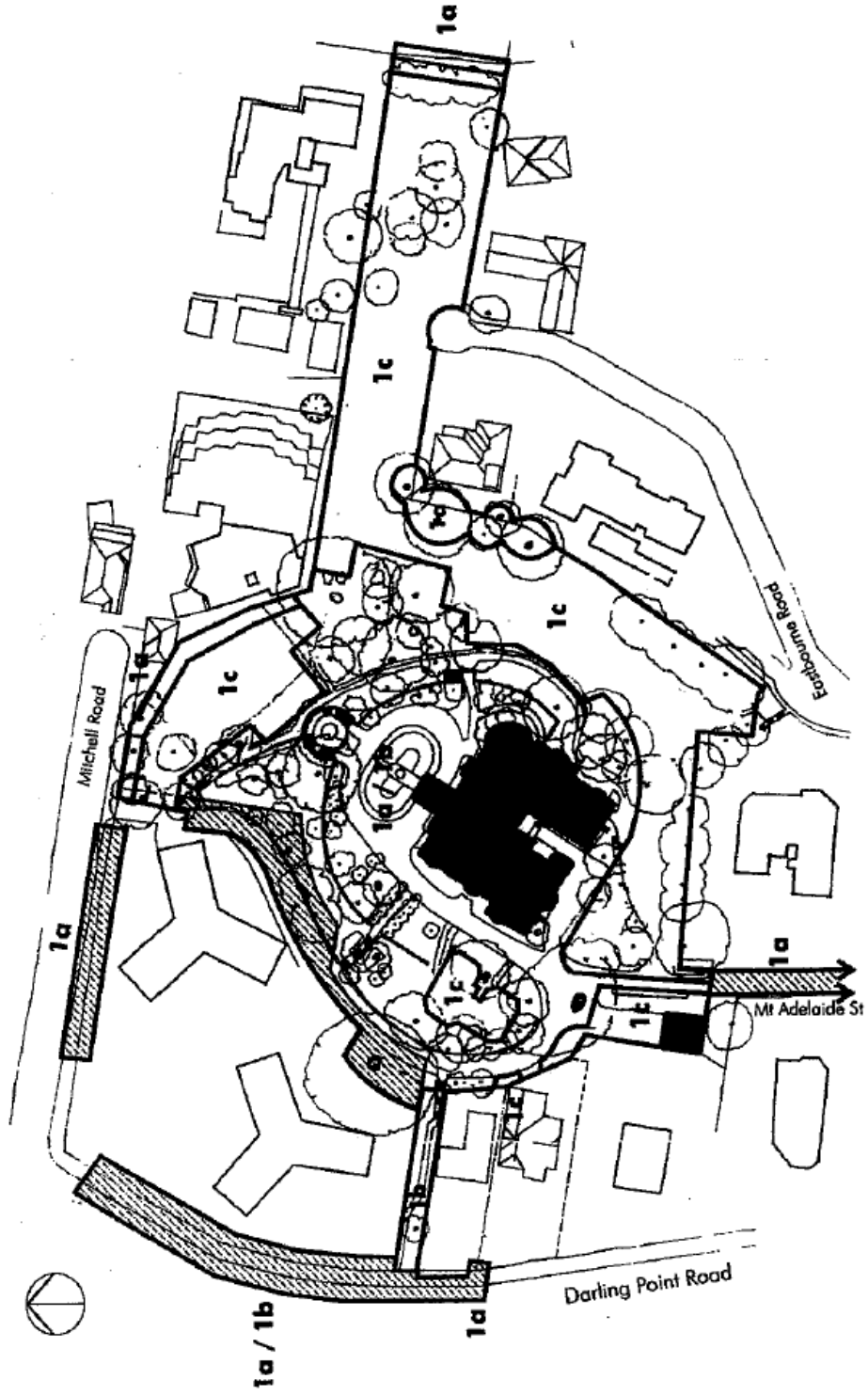
**FIGURE 4** Landscaped graded zones of significance

**1a** – Preservation

**1b** – Repairs/maintenance

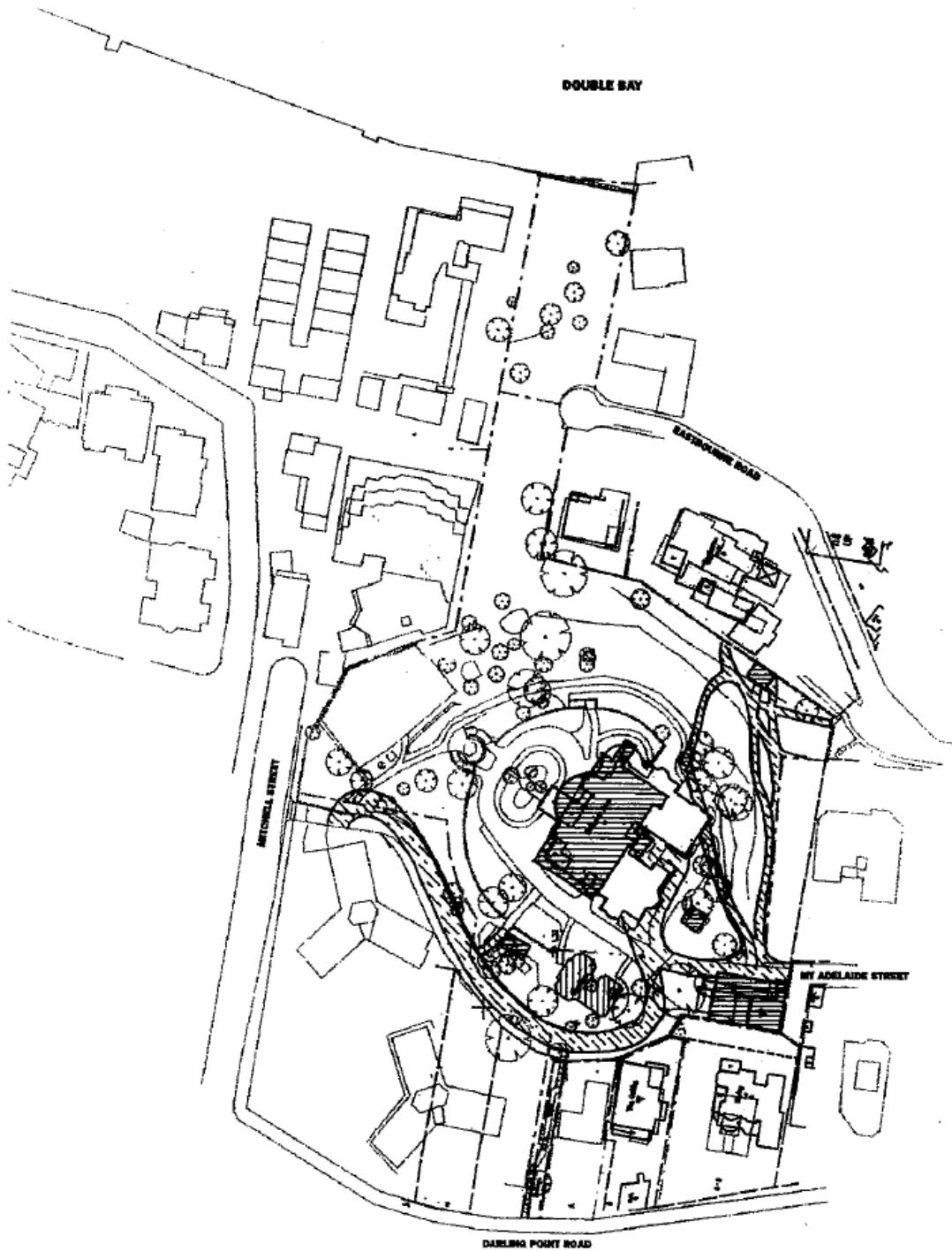
**1c** – Redevelopment/maintenance

 Hatched areas contain significant elements associated with Babworth House which exist outside the present site boundary



**FIGURE 5** Archaeological zoning plan

-  **Zone A** – Mt Adelaide house and outbuildings
-  **Zone B** – Mt Adelaide landscape features
-  **Zone C** – Features associated with Babworth House



---

### G1.4.3 Site layout

---

Site layout refers to the arrangement of buildings, spaces and access arrangements over the site.

#### Objectives

- 01 To achieve a site layout that considers and respects the existing character and cultural significance of the site.
- 02 To achieve a site layout that relates to the site analysis referred to in Section 1.4.1 and the adopted Conservation Management Plan.
- 03 To protect views to, from and over the site.
- 04 To maintain a visual landscape link between Babworth House and the harbour.
- 05 To provide a high level amenity for future occupants of the site and maintain the amenity of neighbouring properties.

#### Controls

- C1 The site layout:
  - a) locates new buildings within the landscaped zone of significance (see Figure 4);
  - b) takes into consideration and respects the dominant position of Babworth House;
  - c) takes into consideration the orientation and placement of buildings for solar access;
  - d) retains or where possible enhances the significant attributes of the site (e.g. views, vistas, substantial trees, spaces and elements);
  - e) relates building and landscape design to the site topography and to the desired future character objective of the site;
  - f) retains trees in the 'finger of land' to the waters of Double Bay, as identified in the adopted Conservation Management Plan;
  - g) takes advantage of multiple access points and existing driveways;
  - h) provides opportunities for access to and use of public transport; and
  - i) respects and does not obscure or confuse the historic site layout.
- C2 The site layout provides for retention of the principal view corridors as identified in Figures 6 and 7.

- C3 Development is located within the building areas nominated in the Conceptual Layout Plan and Site Precinct Plan (see Figures 8 and 9) and is within the building envelopes nominated in the Building Envelope Diagrams (see Figures 10-18).

Note: All building envelopes are indicative. Provisions of the *Environmental Planning and Assessment Act 1979* and statutory provisions within environmental planning instruments which apply to the land together with the planning principles, objectives and controls mentioned in this chapter take precedence over the Conceptual Layout Plan (Figure 8) and the building envelopes (Section 1.4.4).

Council may require deletion or variation of building envelopes or footprints if the proposed development is considered by Council to be unsatisfactory in terms of the relevant provisions of the Act, the environmental planning instruments, planning principles, objectives and controls.

FIGURE 6 Existing view corridors – views from Babworth House

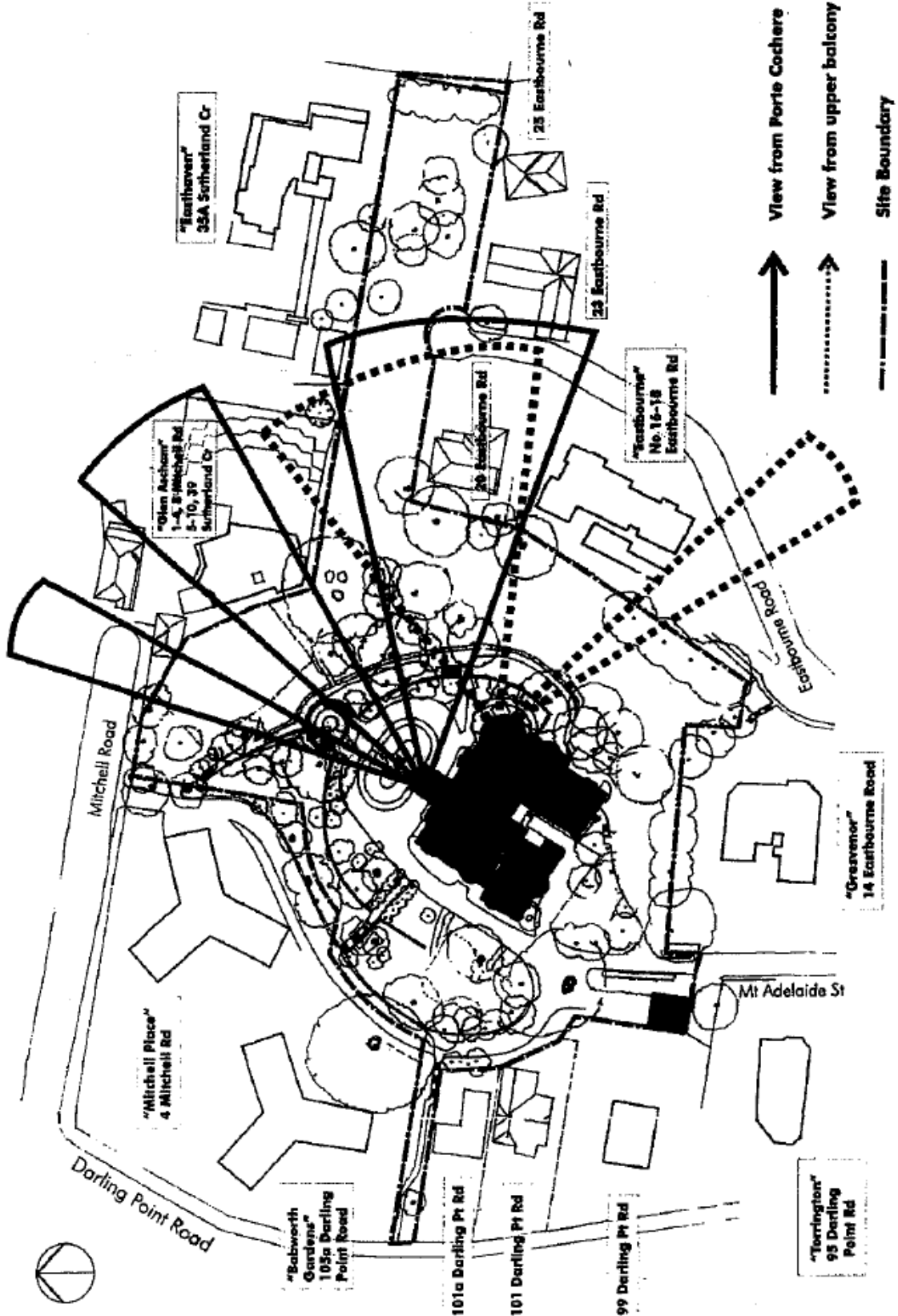


FIGURE 7 Existing view corridors – views over Babworth House

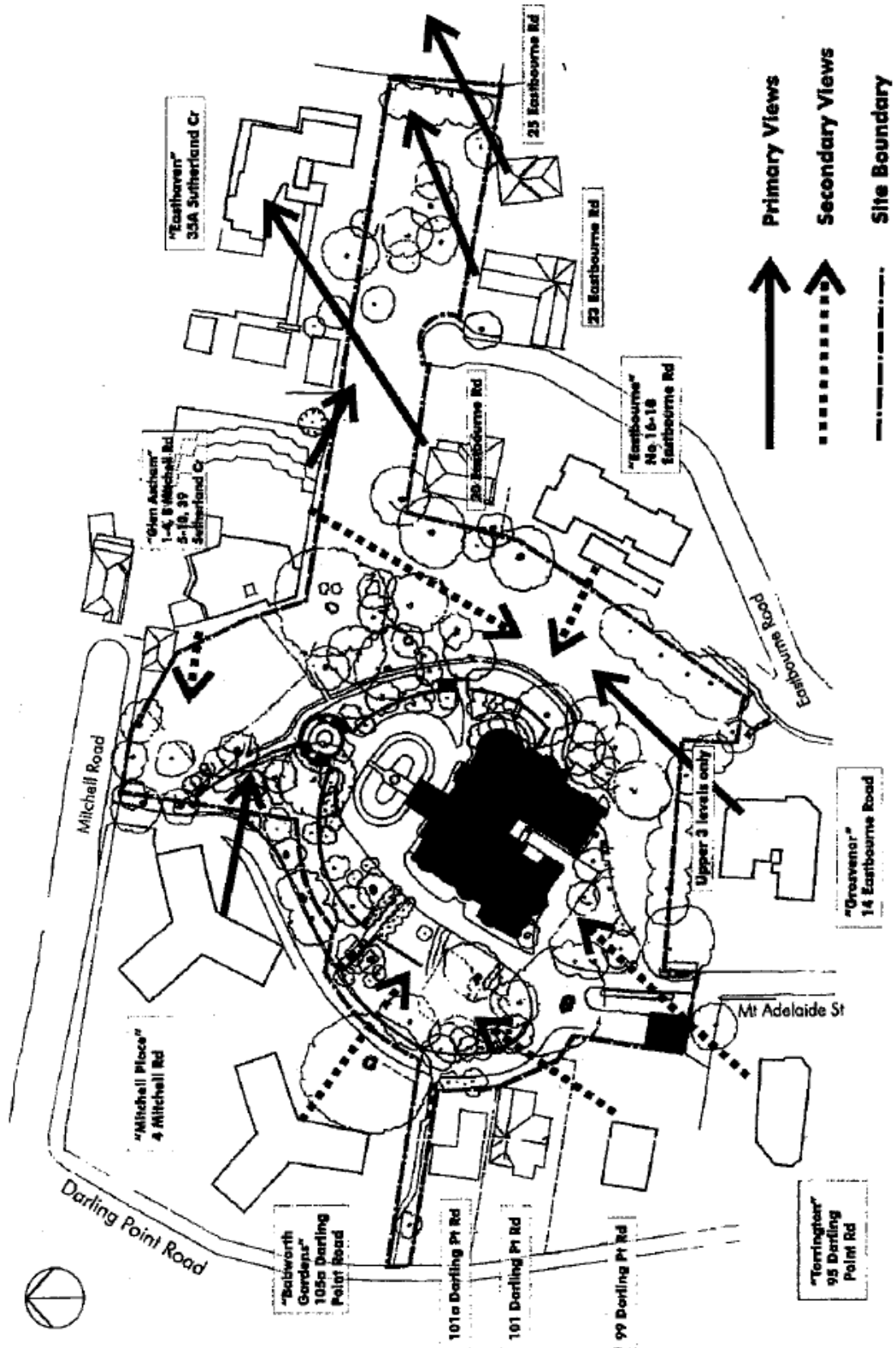
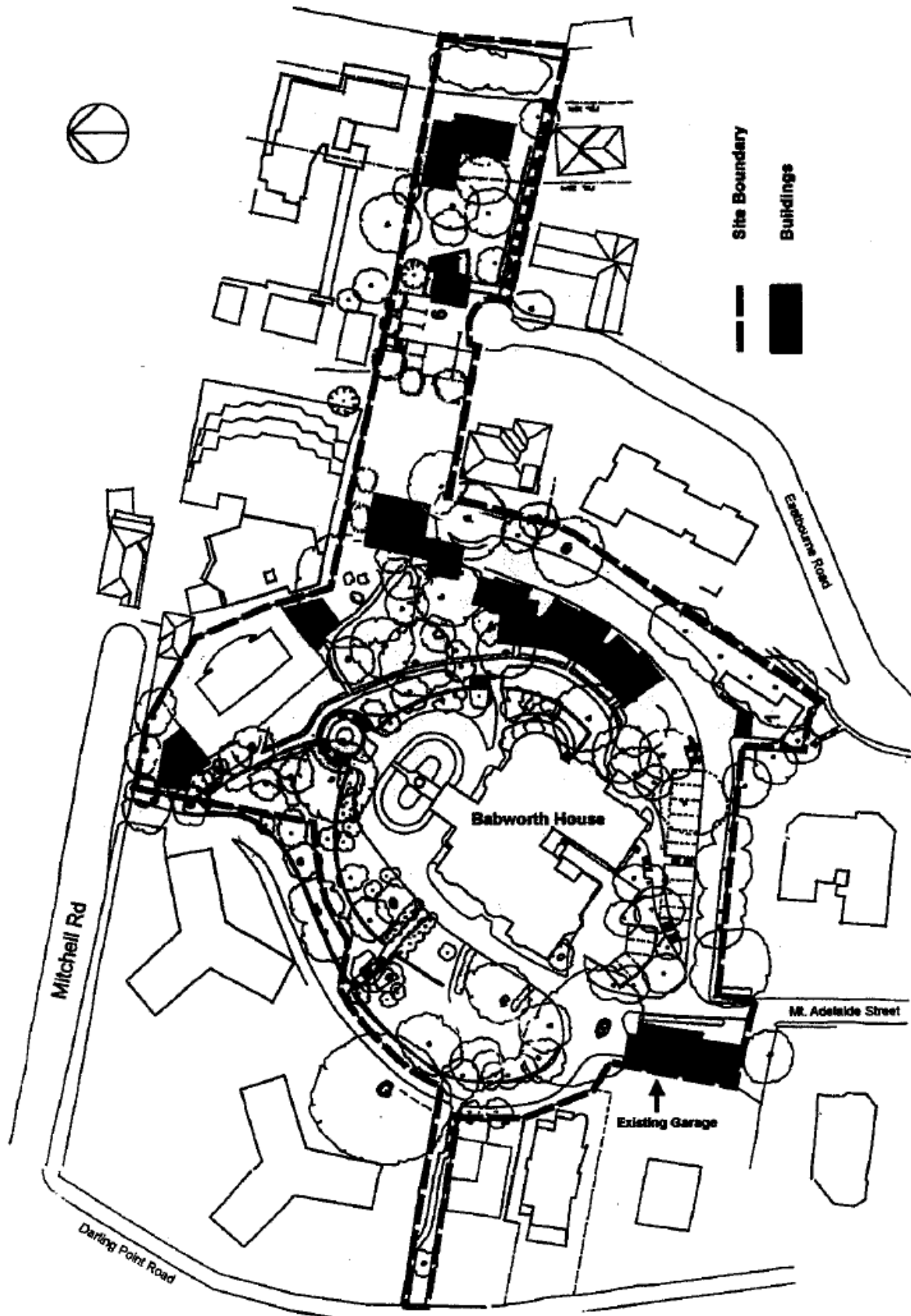




FIGURE 8 Conceptual layout plan



---

### G1.4.4 Building envelope

---

The siting and scale of buildings, including height and setbacks, set the character of development on the site.

Building envelope provisions have been established to control the siting, scale, bulk and height of development so that it satisfies the desired future character objectives and is appropriate in terms of impacts on Babworth House and adjoining properties.

The building envelope represents the maximum limits of development and may not be able to be achieved in all circumstances.

#### Objectives

- 01 To ensure the built form and intensity of new development respects the scale and character of Babworth House and does not detrimentally affect the significant attributes on the site.
- 02 To ensure the built form and intensity of new development respects the desired future character of the area and does not detrimentally affect the amenity of the area.
- 03 To protect principal views to, from and over the site and ensure buildings are of a height and scale which allows the sharing of views.
- 04 To allow adequate daylight, sunlight and ventilation to living areas and private open space of new and neighbouring development.
- 05 To preserve significant trees and vegetation and retain a landscape link to the harbour.
- 06 To maintain where possible the existing topography of the site.

#### Controls

- C1 Buildings are located only within the 1c landscape zone of significance as identified under the adopted Conservation Management Plan (see Figure 4) and generally within the nominated building footprints identified in the Conceptual Layout Plan (see Figure 8).
  - C2 Buildings are located within a building envelope nominated in the Building Envelope Diagrams provided for each precinct. The precincts are those identified on the Site Precinct Plan (see Figure 9). Individual building envelopes are identified in Figures 10-18.  
  

Note: All building envelopes are indicative. Provisions of the *Environmental Planning and Assessment Act 1979* and statutory provisions within environmental planning instruments which apply to the land together with the planning principles, objectives and controls mentioned in this chapter take precedence over the Conceptual Layout Plan (Figure 8) and the Building Envelope Diagrams (Figures 10-18).
  - C3 Council may require deletion or variation of building envelopes or footprints if the proposed development is considered by Council to be unsatisfactory in terms of the relevant provisions of the Act, the environmental planning instruments, planning principles, objectives and controls.
-

---

For instance, Council may require additional setbacks from boundaries, variations to the building footprint and variations to the building envelopes, including reduction in height in order to mitigate the impact of development on the residential amenity of the site and adjoining properties, maintain view corridors, promote view sharing, improve or maintain solar access, retain significant trees and site elements and minimise excavation.

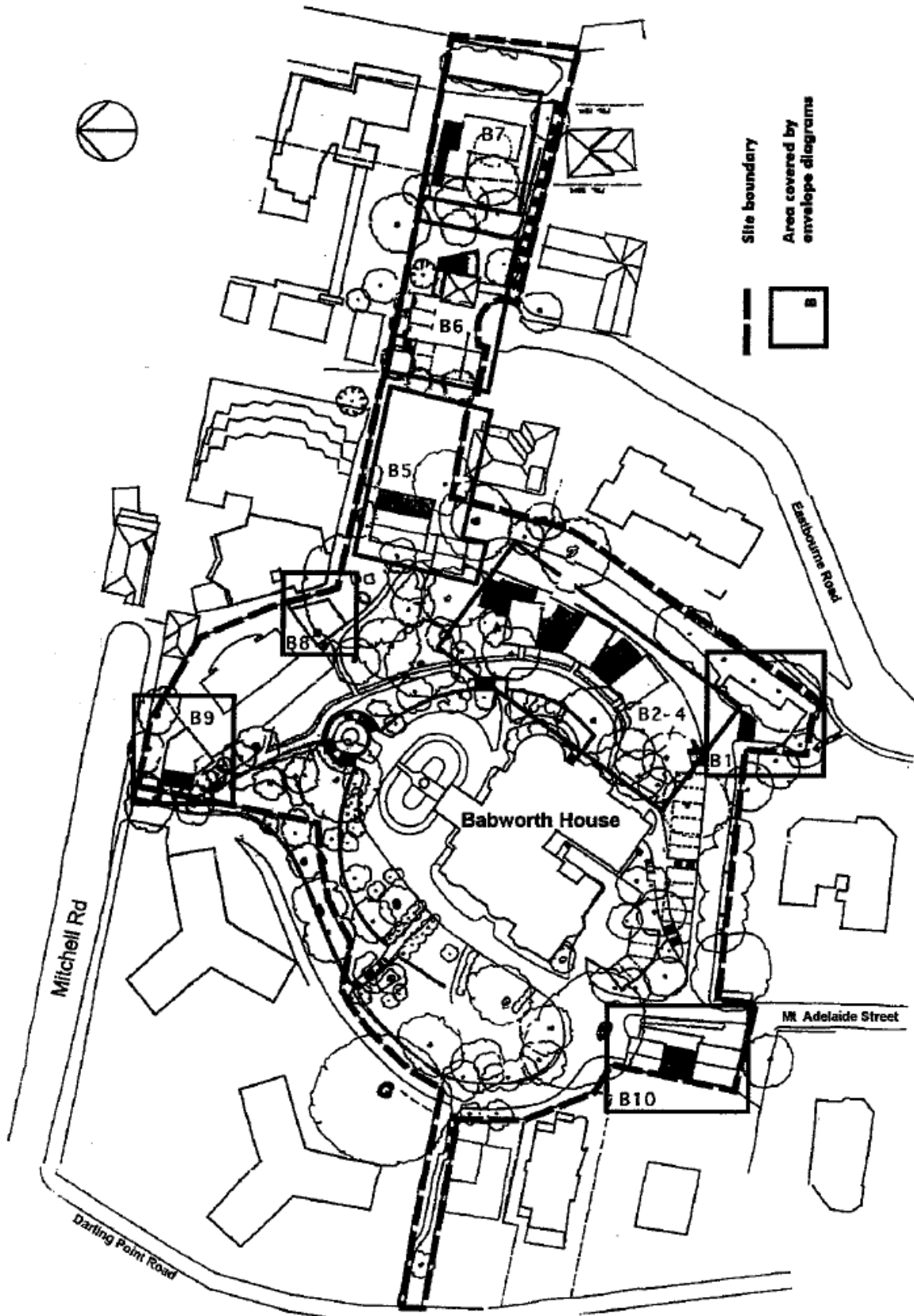
- C4 Balconies, decks, bay windows, non-retractable awnings or other non-retractable solar screening devices and roof terrace balustrades are to be included within the planes of the building envelopes.
- C5 Fascias, gutters, downpipe, eaves up to 0.6m, masonry chimneys, flues, pipes, domestic fuel tanks, cooling or heating appliances or other services, retractable solar screens and blinds, light fittings, electricity and gas meters, aerials, steps, landings may project beyond the planes of the building envelope provided it can be demonstrated that views and privacy are not compromised.
- C6 Conserving significant trees, elements, vistas and archaeological remains as identified in the adopted Conservation Management Plan takes precedence over the permissible maximum building envelopes described in Figures 10-18. The envelopes may therefore need minor adjustment.
- C7 Stepped buildings are encouraged on steeply sloping land within the building footprints and building envelopes identified in Figures 10-18.
- C8 Buildings are sited and designed so that:
- a) privacy is provided to adjoining dwellings;
  - b) sunlight is provided to at least 50% (or 35m<sup>2</sup> with minimum dimension 2.5m, whichever is smaller) of the main ground level private open space of adjoining properties for a minimum of two hours between 9am and 3pm on 21 June. Where existing overshadowing is greater than this, sunlight is not further reduced by more than 20%;
  - c) adequate daylight is provided to habitable room areas in adjoining dwellings;
  - d) building forms enable a sharing of views with surroundings and permit views from public streets and open spaces; and
  - e) the building footprint minimises cut and fill.
- C9 Development has a minimum side boundary setback of 1.5m, increased on a pro rata basis by 0.5m for each additional metre (or part thereof) that the wall height adjacent to the boundary exceeds 3m.
- C10 The building envelope complies with the maximum height limit under the Woollahra LEP 2014.
- C11 If a variation to the maximum height limit is sought through clause 4.6 “Exceptions to development standards” in Woollahra LEP 2014 for development on any part of the site, it must as a minimum requirement contain the following information:
- a) a description of the particular nature and condition of the site and any other circumstances which has led to a design which exceeds the height limit; and

- 
- b) a statement which describes how the design satisfies the relevant planning principles, the desired future character objectives and the objectives and performance controls for site layout, building envelope, landscape, open space and acoustic and visual privacy as set down in this chapter.
- C12 Development on Lot E is to be of a design and is to use a method of construction which requires minimal excavation. Any building on Lot E is to be of a stepped design which responds to the sloping nature of the land.
- C13 All new buildings and works shall not be built within the canopy drip line of significant trees unless information to the satisfaction of the Council can be provided which demonstrates that the construction technique, excavation works, construction works and finished buildings together with associated servicing and landscaping will not have an adverse impact on the immediate and long term preservation, health, vigour and aesthetic quality and the likely future growth habits of the trees.
- C14 Buildings B2-B5 are designed and located so as to:
- a) ensure the retention of the Cape Honeysuckle (*Tecomaria capensis*) hedge adjoining the gravel pathway to the east of Babworth House; and
  - b) ensure that the buildings are not visible from the upper garden terrace adjoining the eastern side of Babworth House (generally with a ground level of RL 53 AHD).

Note: Ground levels shown on the building envelope diagrams are indicative and are required to be accurately determined for development applications by survey carried out by a qualified surveyor.

The number and location of floor levels shown within the building envelope on the isometric and section diagrams are suggestive rather than prescriptive.

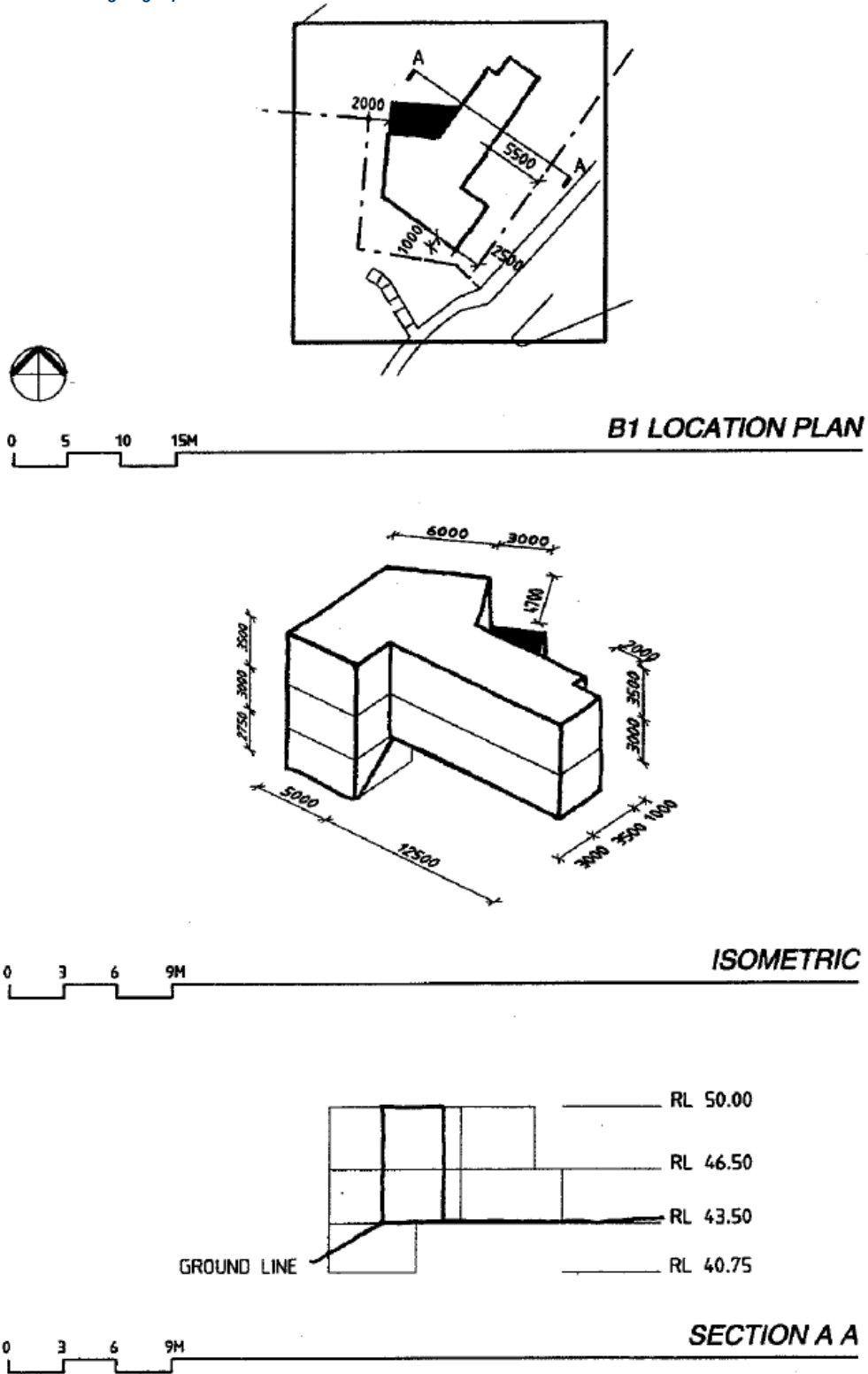
FIGURE 9 Site precinct plan



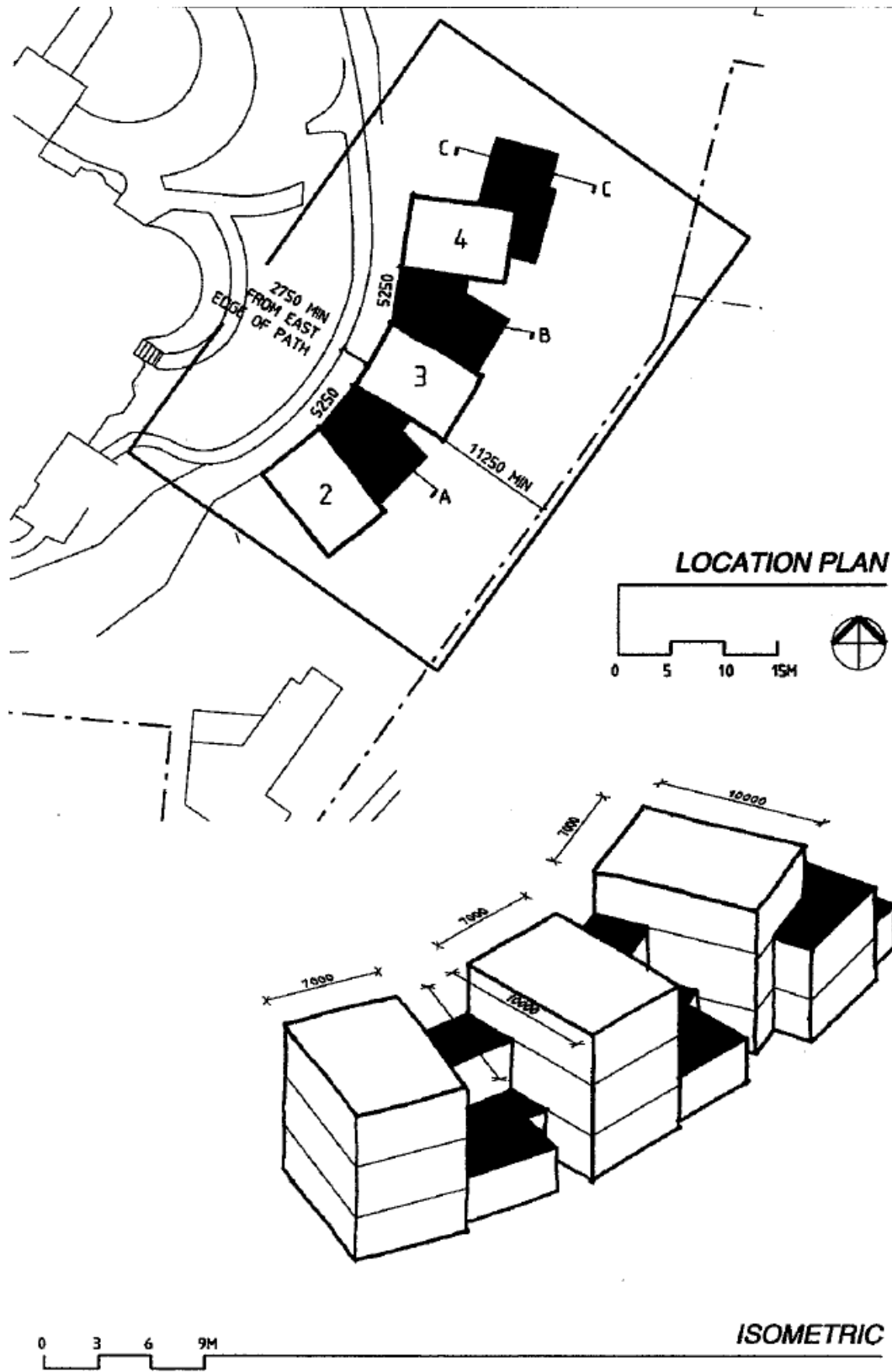
**FIGURE 10 B1 – Building envelope diagram**

All levels are to AHD

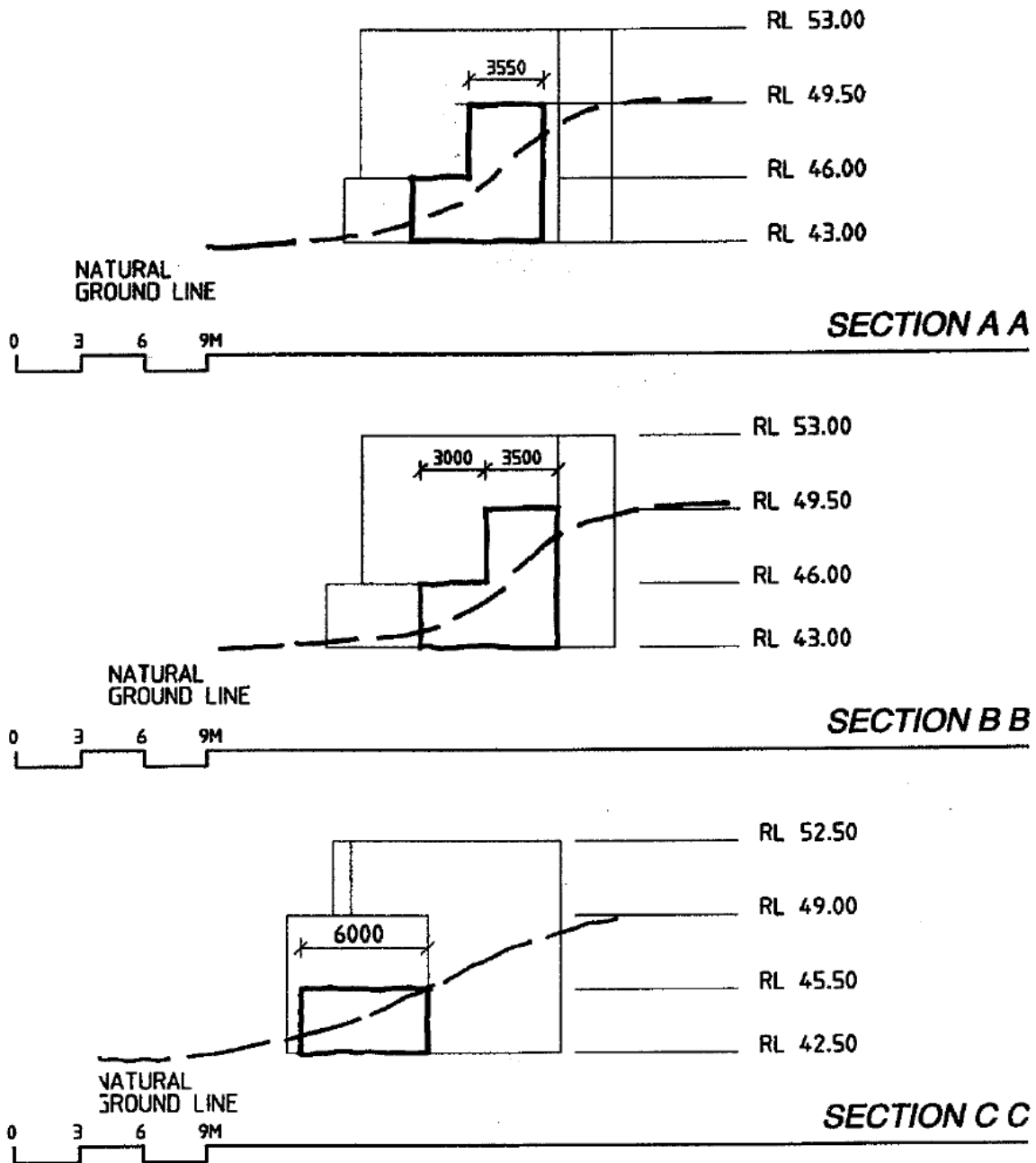
Note: Areas shaded light grey are terraces



**FIGURE 11** B2 to B4 – Building envelope diagram (location and isometric)  
All levels are to AHD



**FIGURE 12 B2 to B4 – Building envelope diagram (sections)**  
All levels are to AHD

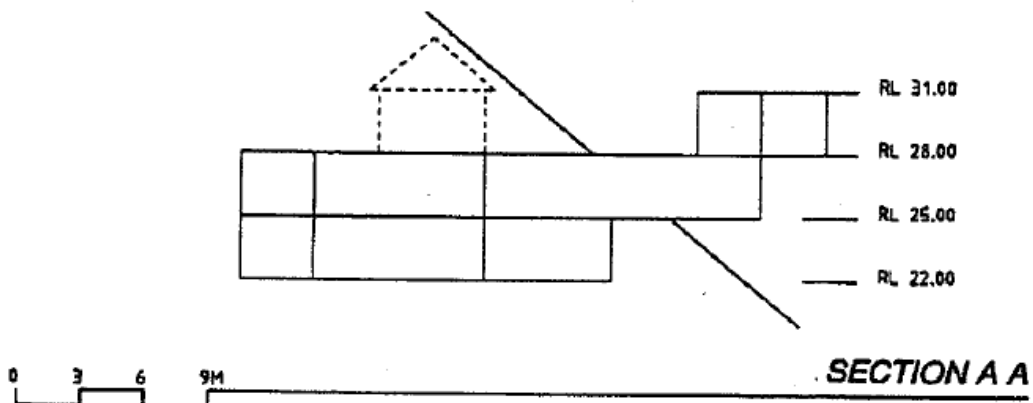
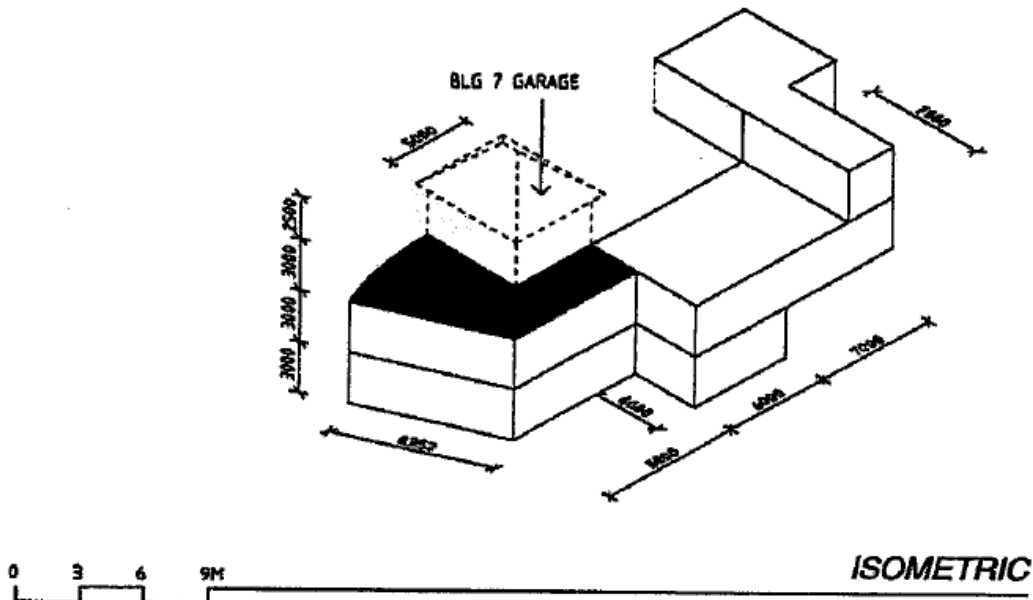
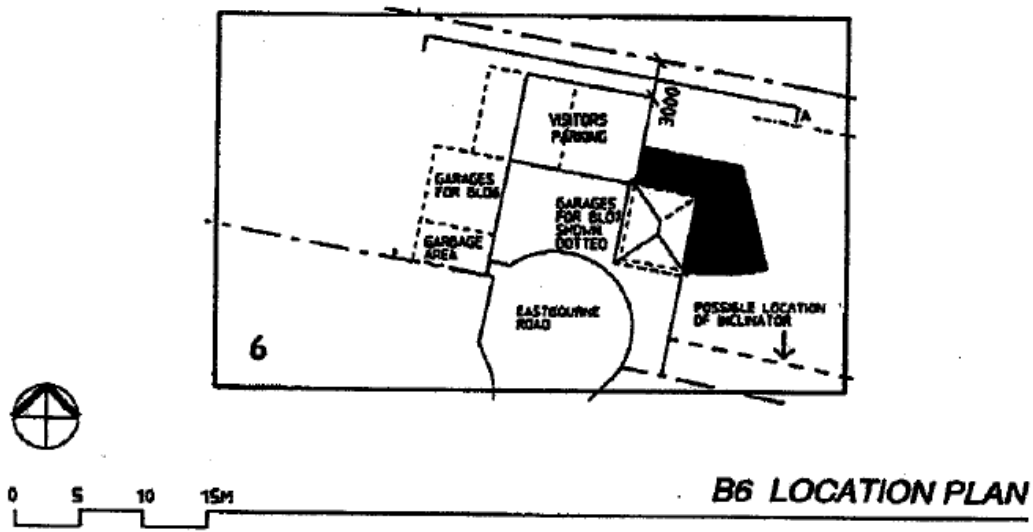






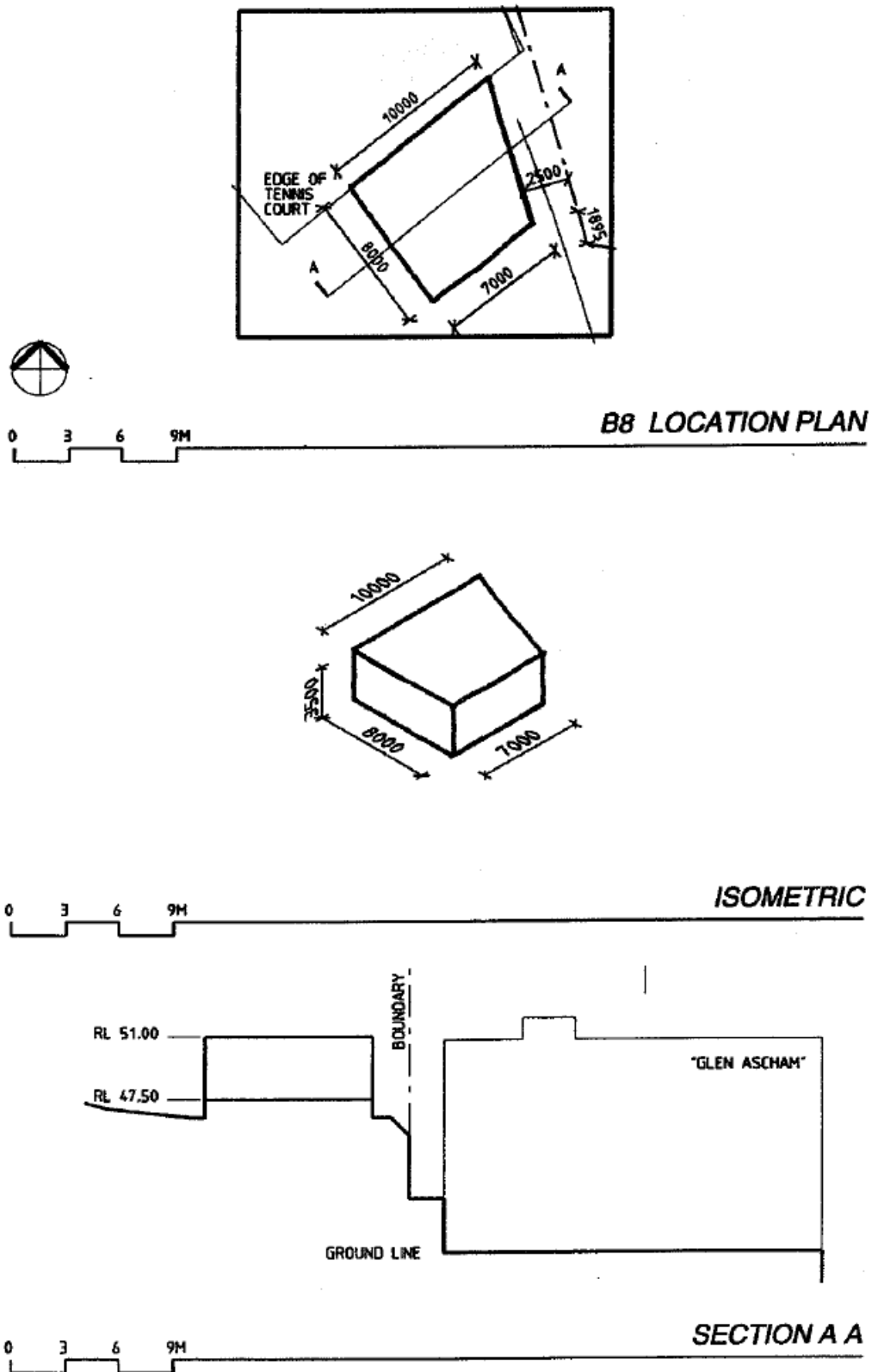
**FIGURE 14 B6 – Building envelope diagram**

All levels are to AHD



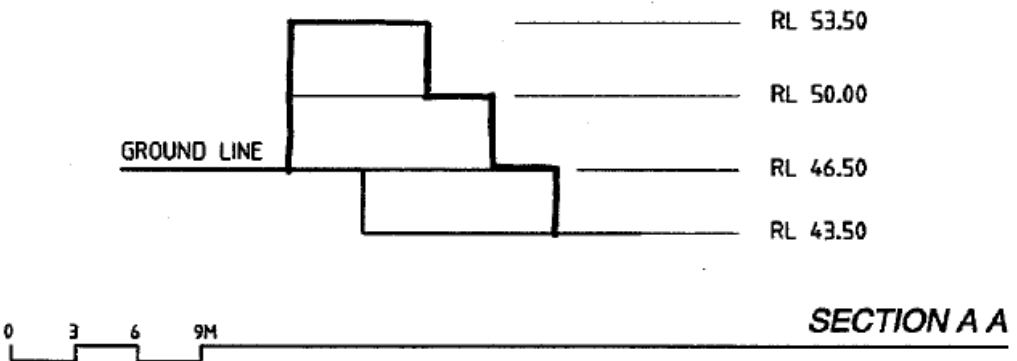
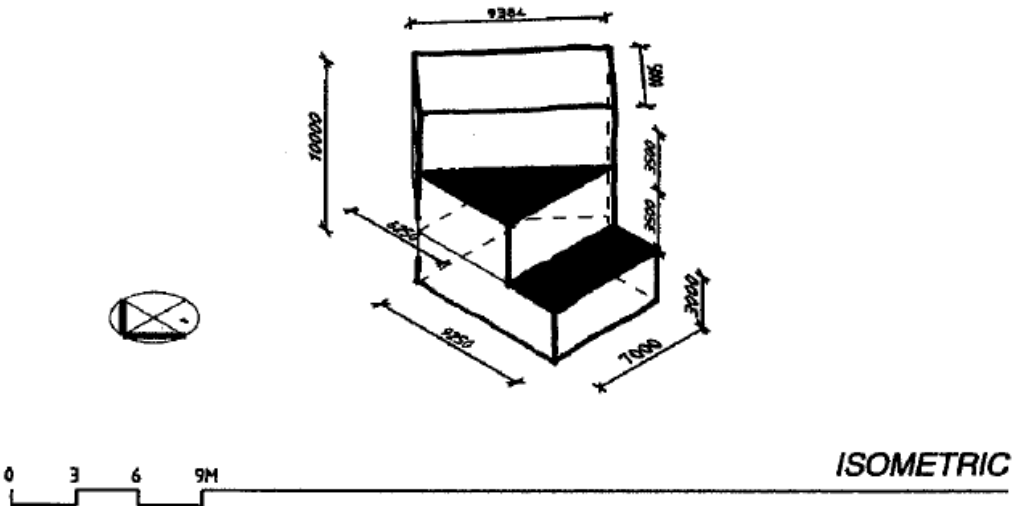
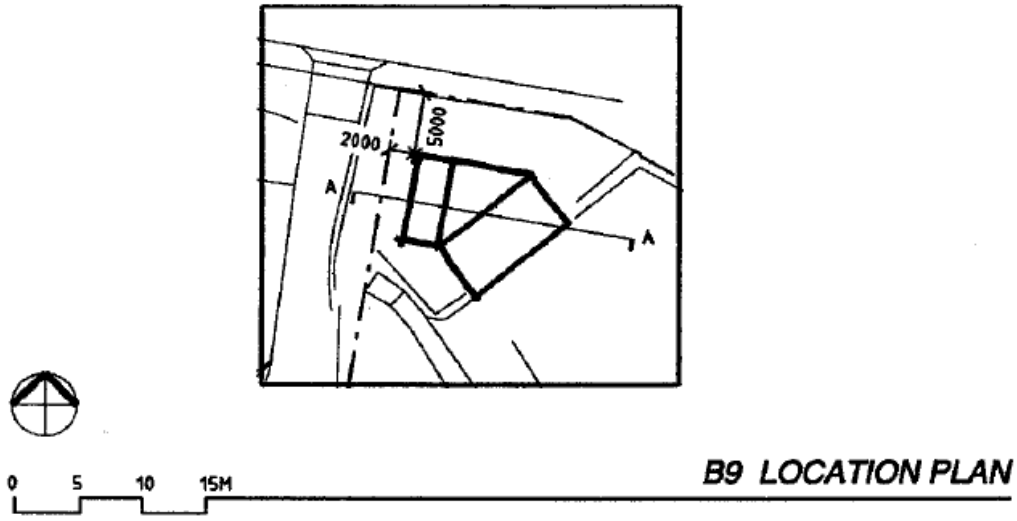


**FIGURE 16 B8 – Building envelope diagram**  
All levels are to AHD

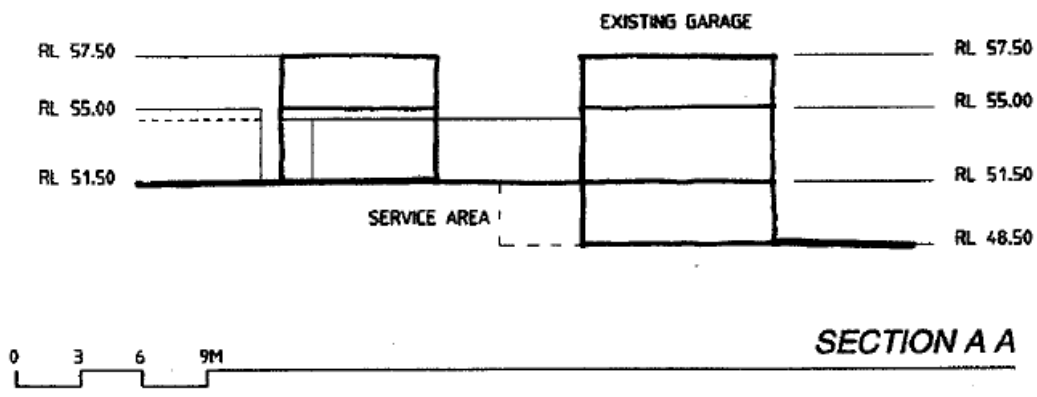
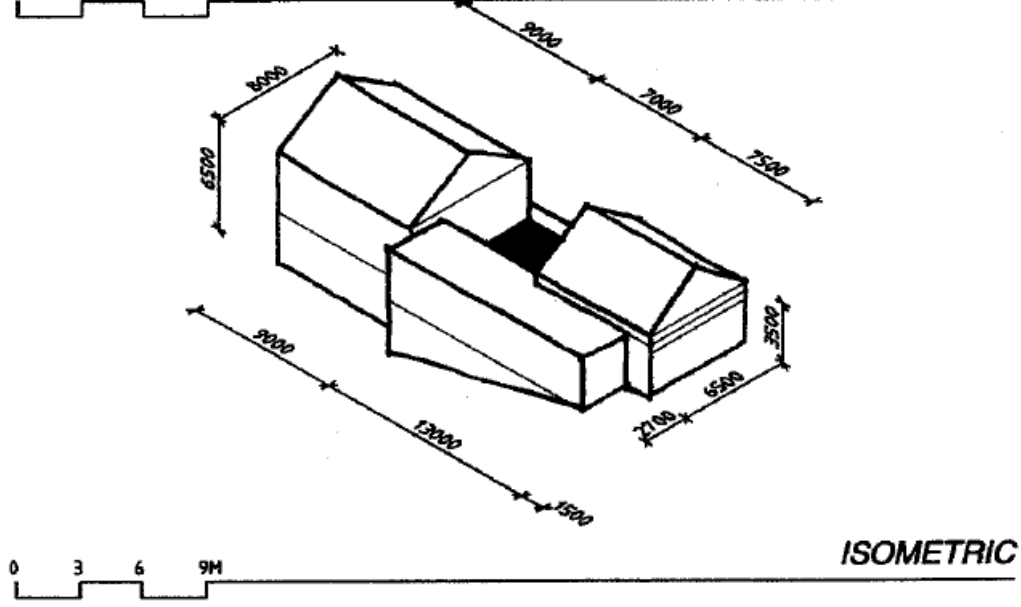
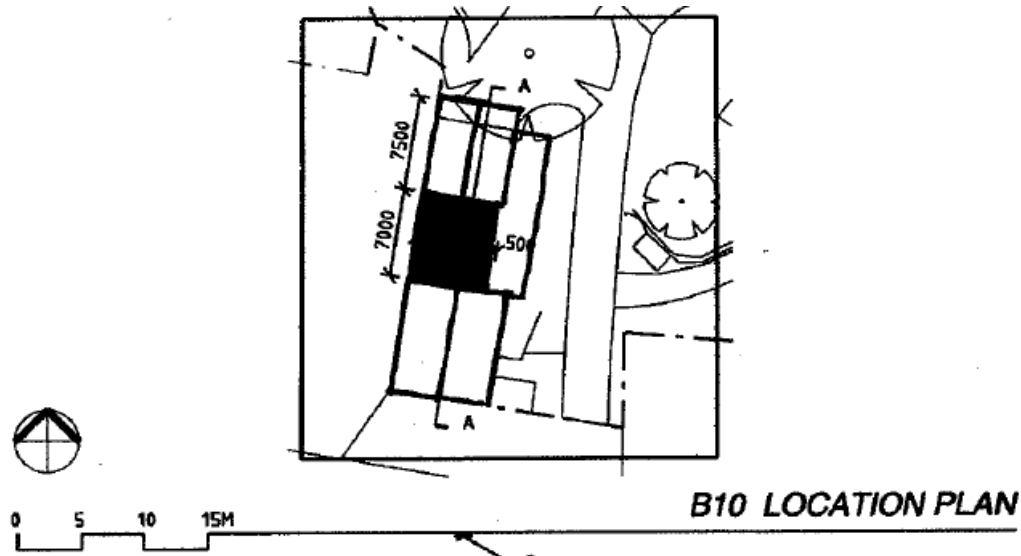


**FIGURE 17 B9 – Building envelope diagram**

All levels are to AHD



**FIGURE 18 B10 – Building envelope diagram**  
All levels are to AHD



---

### G1.4.5 Design elements, roof form and building materials

---

New buildings and alterations and additions should have a consistency of character, form and colour, so that they are identified as ‘belonging’ to the Babworth House Estate and are subservient to the overall character of the Estate.

Construction techniques and materials important determinants of energy efficiency and the amount of non-renewable resources used in development.

#### Objectives

- 01 To promote building design that complements the architectural style and cultural significance of Babworth House and grounds without mimicking them.
- 02 To encourage referential and appropriate contextual design.
- 03 To promote a consistency between the new buildings on the site so that each clearly constitutes part of an integrated estate with a common design theme or character.
- 04 To encourage a variety of suitable roof forms that retain principal view corridors and solar access on and beyond the site.
- 05 To encourage the use of quality craftsmanship, materials and finishes for the exterior of new buildings and structures.
- 06 To encourage contemporary design of any new buildings or structures which through its design idiom, scale, massing, materials, detailing and construction techniques provides an appropriate response to the cultural significance of Babworth House and its landscape setting.
- 07 To encourage the use of reusable, recyclable and renewable resources in construction.
- 08 To promote energy efficient development.
- 09 To maximise the life cycle of buildings in order to reduce energy costs in demolition, reconstruction and recycling.

#### Controls

- C1 A design statement is submitted with development applications. In the design statement the applicant must demonstrate that the proposed design through the design idiom, scale, massing, materials, detailing and construction techniques appropriately respond to the cultural significance of Babworth House and its setting.
- C2 Particular regard is given to roof design so as to protect existing views from buildings on adjoining properties.
- C3 Where pitched roofs are permitted on the Building Envelope Diagrams (see Figures 10-18), the roof pitch is within the range of 30° to 45°.

- C4 Where permitted on the Building Envelope Diagrams (see Figures 10-18), pitched roofs are sheeted with copper, zinc, slate or suitable slate substitute to complement Babworth House.
- C5 Flat roofs are concrete plus waterproof membrane and covered with landscaping, water and/or min. 25mm gauge pebbles of approved colour.
- C6 The impacts of large unbroken expanses of wall are suitably reduced by articulation, modelling, window openings etc.
- C7 Solid, external walls of new buildings are cement rendered, integrally coloured or painted. A minimum of 70% of these solid walls throughout the site are painted the same colour and this colour is of a hue value of not less than 3-8 if white is 1 and black is 10. This is not a restraint on colour but on tone and applies in order to relate to the external colour of Babworth House.
- C8 Windows and external doors and frames are painted, and this colour is of a hue not less than 3 if White is 1 and Black is 10 (as for external walls).
- C9 Mirrored or other highly reflective materials (with a reflectivity of 15% are not used on building exteriors.
- C10 Buildings have a good thermal mass through the use of materials such as concrete slab floors, cavity brick, concrete block and stone walls.
- C11 Materials of high thermal mass are used for living areas and are located to maximize the absorption of heat from air circulating in the dwelling and from winter sun.



---

### G1.4.6 Landscape, open space

---

High quality landscape design is important for the creation of a quality setting, integrating the new buildings on the site with one another and with Babworth House, and in improving the appearance of the development, and the amenity of the area.

Landscaped open space may include the curtilage of Babworth House and significant spaces, and both communal and private open space areas.

Private open space contributes to the amenity of individual dwellings and should be clearly delineated from communal areas. Private open space may be provided at ground or above ground level. Above ground private open space may comprise balconies or rooftop areas.

Communal open space is the shared open space available for use by all residents of the site. Communal open space is for recreation and relaxation of residents may include landscaped areas, swimming pool or tennis court and is controlled by a common management.

Land within Lot E on the foreshore of Double Bay has potential significance as public open space subject to public pedestrian access being available from a public place.

#### Objectives

- 01 To allow conservation and interpretation of the significant landscape and grounds.
- 02 To provide adequate private and communal open space which meets user requirements for outdoor activities and use, and enhances the amenity of the area.
- 03 To retain significant trees, vegetation and other key landscape elements on the site.
- 04 To preserve the landscaped link with the harbour.
- 05 To fully integrate the landscape design in communal, private and public open space areas.
- 06 To enhance stormwater management.
- 07 To enhance the appearance, amenity and energy efficiency of housing through integrated landscape design.

#### Controls

- C1 The masterplan application includes a landscape concept plan which addresses:
  - a) restoration and location of significant landscape zones and elements as identified in the adopted Conservation Management Plan;
  - b) existing vegetation and proposed plantings and landscaping;
  - c) species to be retained and removed;
  - d) methods of delineating private and communal open space (devices such as hedges, changes in level). Fencing within the site is generally not acceptable, except safety fences (e.g. pool fences);

- 
- e) location of communal facilities (e.g. tennis courts, swimming pools, change rooms and garden sheds);
  - f) lighting (e.g. along driveways and pathways);
  - g) watering and irrigation systems;
  - h) areas (m<sup>2</sup>) of private and communal space;
  - i) drainage and stormwater management; and
  - j) other relevant matters identified by Council during pre-DA discussions.
- C2 A detailed landscape plan (including an arborist report) and details of proposed work within 1a/1b graded zoned of significance (identified in Figure 4), prepared by a landscape consultant specialising in historic gardens, is submitted with development applications. A landscape plan includes a plan for the restoration and reconstruction of historic garden areas which is consistent with the historic character of the Babworth House garden.
- C3 Private open spaces are located:
- a) to take advantage of outlook and natural features of the site;
  - b) so as to receive at least 2 hours of sunlight per day in mid-winter, where possible;
  - c) to reduce adverse impacts of adjacent buildings on privacy and overshadowing; and
  - d) to address surveillance and privacy where private open space abuts communal open space or public open space.
- C4 Each dwelling (not being a dwelling unit within the Babworth House building) has private open space with:
- a) a minimum area of 25m<sup>2</sup> for dwellings of 2 or more bedrooms;
  - b) a minimum dimension of 2m;
  - c) direct access from a living area of the dwelling; and
  - d) delineation or screening where necessary to ensure privacy to users.
- C5 Any communal open space:
- a) provides adequate space for recreational uses;
  - b) maintains principal views and landscape character of the site;
  - c) assists with stormwater management;
  - d) links visually and functionally the new buildings within a consistent landscape framework or theme; and
  - e) is accessible to users.
- C6 Where there are communal open space areas, Council will require a Landscape Management Plan to provide details of the care, control and maintenance of all communal areas and facilities.

- 
- C7 The design for private and communal open space:
- a) recognises the heritage landscape through the use of materials and plant species;
  - b) uses vegetation types and landscape materials, features and works which will not adversely affect the structure of proposed buildings or buildings on adjoining properties;
  - c) considers personal safety by ensuring good visibility along paths and driveways;
  - d) contributes to energy efficiency and amenity by providing substantial shade in summer, especially to west-facing windows and open car park areas and admitting winter sunlight to outdoor and indoor living areas;
  - e) provides privacy between dwellings;
  - f) avoids risk of damage to overhead power lines, sewer lines, stormwater drainage lines and other services; and
  - g) limits hard and impervious services at ground level to minimise potential for runoff from development.
- C8 Landscape design should demonstrate through the use of plant species, hard landscape elements and materials that it provides an appropriate response to the cultural significance of the Babworth House gardens and landscape.
- C9 Tennis courts or swimming pools are located within the areas graded 1c under the adopted Conservation Management Plan (see Figure 4).
- C10 Tennis courts or swimming pools are designed and have regard to existing ground levels of the site and adjoining properties and positioning of the buildings on adjoining properties and on the site.
- C11 Tennis courts or swimming pool are located and designed to mitigate noise and light spill impacts upon adjoining properties. Lighting of tennis courts is not guaranteed.
- C12 Swimming pools are setback from adjoining property boundaries to allow for sufficient landscaping and access.
- C13 Facilities associated with tennis courts or swimming pools are sited and designed to integrate physically and visually with the landscape and other built elements and complement the character of the site.
- C14 Tennis court fencing does not impact significantly on views from or over the site.
- C15 To avoid impact on adjoining properties a swimming pool should not be located in the north-eastern area of the site which comprised the former tennis court to Babworth House.
-

---

### G1.4.7 Acoustic and visual privacy

---

Visual and acoustic privacy is an important contributing factor to the amenity of a place, particularly for residential uses. Privacy needs of both prospective residents and existing neighbours influences the location of buildings and private open space areas, the placement of windows, screening devices (including landscaping) and the selection of materials.

#### Objectives

- O1 To provide adequate acoustic and visual privacy for future residents on the site and residents on adjoining land.

#### Controls

- C1 Buildings demonstrate consideration of:
- a) overlooking impacts to private open spaces and living room windows and mitigation measures;
  - b) locating sensitive areas of use, such as bedrooms, away from noise sources; and
  - c) acoustic treatment of noise sources (particularly plant areas)
- C2 Measures to provide adequate visual privacy include some or all of the following:
- a) a minimum distance separation of 9m where windows/balconies are directly facing;
  - b) off-setting of windows;
  - c) raised sill heights (over 1,600mm above floor levels); or
  - d) screen walls or plantings.
- C3 Acoustic treatment of shared walls and floors between new dwellings are constructed in accordance with the Building Code of Australia.

---

### G1.4.8 Access and mobility

---

Accessways need to be designed to perform their designated function and be compatible with the cultural significance of the site and its desired future character objectives.

Access and mobility provisions are necessary so that developments are accessible and able to be used by all members of the community.

The provisions are principally directed towards eliminating barriers to people with disabilities and the aged.

Because of the heritage significance of the site, access provisions are also necessary to ensure that adequate consideration is given at the design concept stage to the manner in which construction vehicles, equipment, machinery and facilities are to enter and leave the site and move around the site.

Unless otherwise specified, the objectives and controls set out in this section are not advocating or requiring the provision of access to the site by the general public.

#### Objectives

- 01 To ensure that vehicular access to and from the site is safe and convenient.
- 02 To provide public access to the foreshore of Double Bay.
- 03 To preserve the historical pedestrian link with Darling Point Road.
- 04 To ensure new buildings, associated spaces and communal areas are accessible, useable or adaptable for all people in the community, including people with disabilities and the aged.
- 05 To ensure that vehicular access is provided in a way that mitigates traffic impacts.
- 06 To maintain and use historic driveways and pathways, wherever possible.
- 07 To maintain the character and use of historic access points and driveways as configured (no widening) and without significant changes in level.
- 08 To minimise the adverse impact of the movement of construction vehicles, equipment, machinery and facilities on the heritage significance of the site and the amenity of the surrounding neighbourhood.

---

## Controls

- C1 Use existing driveways from Mitchell Road and Mount Adelaide Road, and provide additional access from Eastbourne Road. The Mitchell Road access is via a right-of-way over part of 4 Mitchell Road. The right-of-way provides access only to Lot B of the site. The right-of-way is a private arrangement on the title of 4 Mitchell and continued access to Lot B over the right-of-way cannot be guaranteed by the DCP.
  - C2 Where appropriate, split traffic loads either by several discrete in/out systems or in the case of Mitchell Road and Mount Adelaide Road access points by a one-way connection between those points.
  - C3 Encourage direct pedestrian links to public transport and other facilities or services.
  - C4 Use existing historical pedestrian link with Darling Point Road.
  - C5 Public access is provided (and may be offset against any s.94 contribution) both physically and legally between Eastbourne Road and the foreshore, and along the foreshore. Council acknowledges that due to the steepness of the terrain in this area, access for the mobility impaired may not be achievable.
  - C6 Maintain and encourage use of existing pathways as presently configured. Any new vehicular and pedestrian accessways are to be carefully designed with regard to:
    - a) the location of significant spaces or elements on the site;
    - b) significant trees;
    - c) the landscaped setting and character of the site; and
    - d) the provision of access for people with disabilities.
  - C7 Accessways, driveways and open parking areas are suitably landscaped to enhance amenity while providing for security and accessibility of all residents and visitors.
  - C8 Accessways are designed, surfaced and graded to facilitate onsite stormwater management in accordance with a stormwater management plan.
  - C9 Vehicular accessways and driveways are designed to:
    - a) prevent traffic conflicts;
    - b) enable adequate manoeuvrability for all vehicles;
    - c) enable all vehicles to enter and exit the site in a forward direction;
    - d) enable vehicles to pass (where appropriate); and
    - e) reduce speed.
  - C10 New driveways are of bitumen with clay or concrete brick kerbing, edges, trims and gutters.
  - C11 The extension to Eastbourne Road is of brick or concrete paving.
  - C12 The materials for new pedestrian pathways are gravel or bitumen with a brick edge or brick paved.
-

- 
- C13 Paths provide uninterrupted, comfortable access for people with disabilities to all facilities and amenities generally accessible to building users.
- C14 Parking spaces are adequately designed to provide easy, convenient and safe access to all buildings or facilities within a development.
- C15 Doors and doorways are of adequate width and design to enable access to all public areas within a building (see Building Code of Australia for details).
- C16 All accessories such as door handles, bell pushes, switches and mail boxes are easy to manipulate and are located at an appropriate height.
- C17 The finish on ground and floor surfaces does not restrict access.
- C18 Signs including visual alarms are visible and legible to as many people as possible, including people with sight impairments or colour blindness.
- C19 A construction management plan is provided and is to include:
- a) the proposed movement of construction vehicles, equipment, machinery and facilities to, from and within the site;
  - b) the phases of construction;
  - c) the types of vehicles, equipment, machinery and facilities to be used throughout the construction;
  - d) the periods and times during the construction when movement will occur;
  - e) the steps which are to be taken to mitigate adverse impacts on the heritage significance of Babworth House and the site, the amenity of the surrounding neighbourhood and on-street parking; and
  - f) the location of materials and machinery stores.

Note: The use of right-of-way over 4 Mitchell Road by construction vehicles and for the storage of construction materials should be avoided other than where that use is associated with traffic management works, maintenance works and works which provide for the future shared pedestrian and vehicle use of the right-of-way.

---

### G1.4.9 Car parking and servicing

---

The onsite car parking requirements aim to satisfy the parking demand likely to be generated by residential development while discouraging unnecessary car use and site excavation resulting from the provision of overly-generous amount of on-site parking.

Limiting unnecessary car use and encouraging other modes of transport, such as walking, cycling and public transport helps to improve local amenity and minimise pollution and the use of non-renewable energy sources.

Parking areas, garages and driveways must be designed carefully so that they do not detract from the appearance of the development and the surrounding streetscape.

The design of parking and driveway areas should also acknowledge the need to limit the amount of impervious surfaces over a site and the amount of site excavation.

The overly generous use of impervious surfaces such as paving and bitumen can increase temperature in warmer months and lead to excessive stormwater runoff.

Excessive excavation can lead to site instability and interrupt ground water flows relied upon by surrounding vegetation.

#### Objectives

- 01 To maintain the integrity and amenity of Babworth House and its landscaped setting.
- 02 To maintain the amenity of adjoining properties and the safe and efficient operation of the local road network.
- 03 To provide convenient and safe car parking and access for residents and visitors.
- 04 To limit site excavation resulting from development.
- 05 To ensure that onsite car parking and driveways do not dominate or detract from the appearance of development and the integrity and amenity of Babworth House and its landscape setting.
- 06 To limit the adverse temperature and stormwater run-off impacts of impervious alternative modes of transport.
- 07 To encourage the use of public transport and alternative modes of transport.
- 08 To encourage suitably landscaped open car parking areas and accessways while providing for the needs of residents and visitors.



## Controls

C1 The number of car parking spaces to be provided on the site is outlined in the table below.

Dwelling size	Number of spaces provided
1 bedroom	1 space/dwelling
2+ bedroom	2 spaces/dwelling
Visitors	¼ dwellings
Babworth House	Maximum of 14 spaces irrespective of use

C2 For uses other than those identified in PC1 or where variation to the rates set out in PC1 are sought, Council will consider parking provisions on its merits and in light of a traffic and parking report, to be submitted with development applications and other relevant considerations (e.g. heritage and amenity).

C3 Parking facilities are designed and located to:

- a) maintain cultural (heritage) significance of the grounds and not detract from the heritage significance of Babworth House and its gardens;
- b) provide easy, convenient and safe access to all buildings;
- c) enable the efficient use of car spaces and accessways, including safe manoeuvrability for vehicles between the parking areas and the street;
- d) preserve significant trees;
- e) reduce the visual dominance of car parking areas and accessways;
- f) enhance the landscaped setting and character of the site; and
- g) generally comply with the vehicular access, parking and servicing arrangements set out in Figure 19. Council may consider other arrangements on their merits.

C4 Innovative solutions in the provision of car parking (e.g. underground, semi-basement) may be implemented, where site conditions permit, to achieve the objectives for parking.

C5 The area of site excavated for the purpose of underground car parking is limited to the building footprint of each building as determined by the building envelope diagrams.

C6 Parking facilities are sited and designed to integrate physically and visually with the landscape and other built elements.

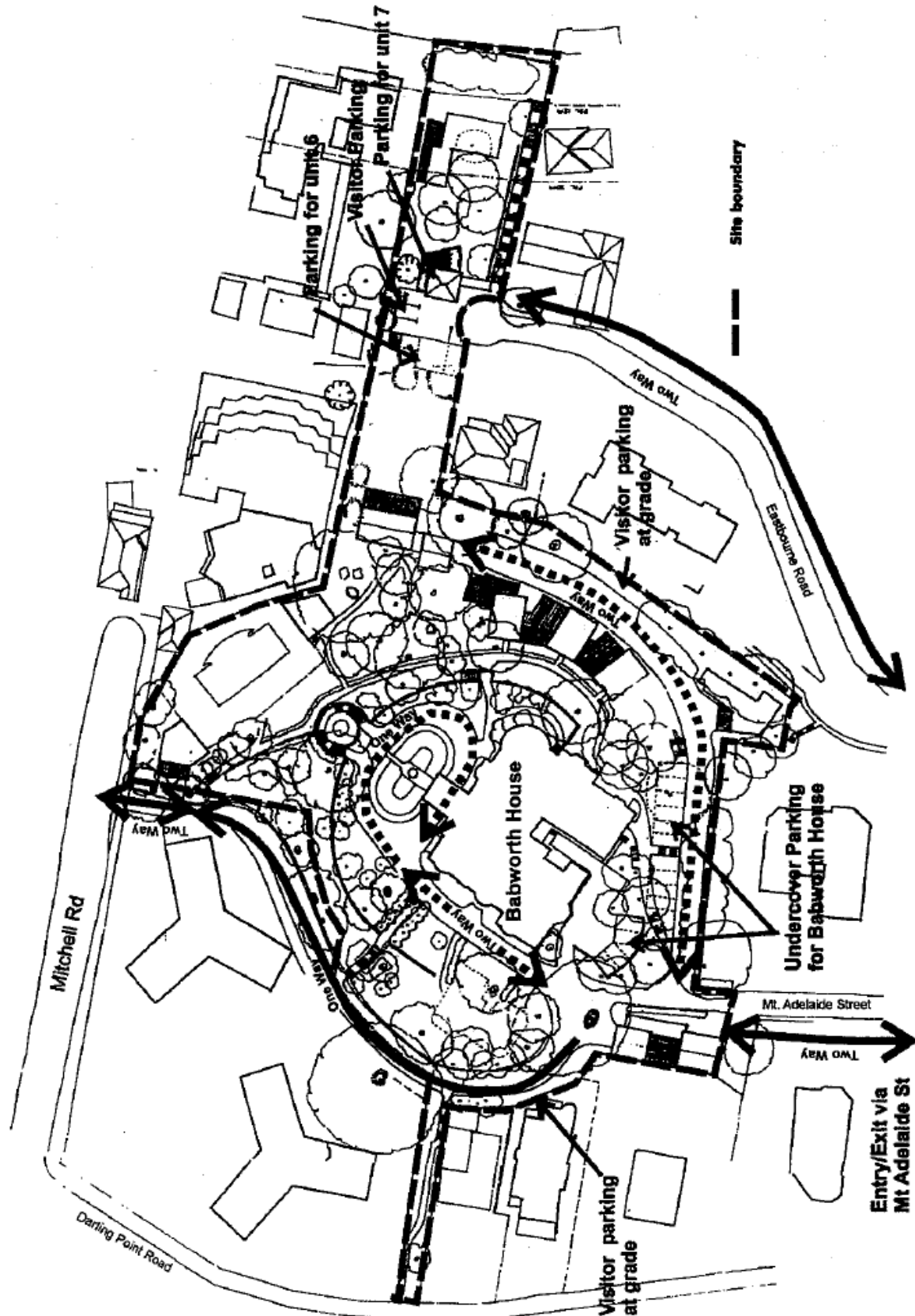
C7 Open car parking spaces are designed, surfaced and graded to facilitate onsite stormwater management in accordance with a Stormwater and Soil Management Plan.

C8 Adequate manoeuvrability and parking is provided for service vehicles.

C9 Utility service reticulation is provided underground.

- C10 One car wash bay is provided at the western at-grade visitor parking area and another at the at-grade parking area adjacent to buildings B2-B4. Each bay is to be graded to an internal drainage point and connected to a Sydney Water Corporation sewer. A trade waste agreement from the Corporation will be required for the connection. Council will favourably consider onsite wastewater recycling if the proposal is plausible.
- C11 The arrangement of parking spaces and driveways allow vehicles to enter and leave the site in a forward direction.
- C12 Accessways and driveways are designed to enable vehicles (the 85<sup>th</sup> percentile vehicle) to enter the designated parking space in a single turning movement and leave the space in no more than two turning movements.
- C13 Visitor car parking areas are designed to minimise impact on adjoining properties in regard to matters including noise and vehicle lights.

FIGURE 19 Vehicular access, parking and servicing



---

### G1.4.10 Site facilities

---

The main site facilities (other than those associated with tennis courts, swimming pools etc. as per Section 1.4.6) requiring design attention include:

- ▶ mail boxes;
- ▶ garbage storage areas; and
- ▶ clothes drying areas.

#### Objectives

- O1 To ensure site facilities are effectively integrated and are unobtrusive.
- O2 To ensure site facilities are adequate and accessible to all residents and easy to maintain.

#### Controls

- C1 All facilities are designed to accommodate the needs of people with disabilities and the aged.
- C2 There are minimal standalone structures on the site.
- C3 Garbage storage facilities and mailboxes are sited and designed to integrate physically and visually with other built elements and the landscape design, and complement the character of the site.
- C4 Garbage storage facilities are designed and located to adequately contain noise, odour and visual impacts to residences.
- C5 Residential development includes an outdoor area suitably for located clothes drying facilities. This area is located in a secure place and visually screened from public and communal spaces.
- C6 Garbage storage facilities enable the storage and collection of recyclable material.

---

### G1.4.11 Energy efficiency

---

Energy efficiency provisions aims to promote ecologically sustainable by reducing the emission of greenhouse gases and the consumption of non-renewable resources.

Energy efficiency can also lead to significant cost savings for households.

Energy efficiency provisions for the design of buildings refer to:

- ▶ the orientation of buildings and living areas;
- ▶ the size and location of glazing;
- ▶ shading and landscaping;
- ▶ air movement;
- ▶ insulation; and
- ▶ appliances.

#### Objectives

- O1 To promote ecologically sustainable development through the design of buildings.
- O2 To maximise the benefits of passive solar design.
- O3 To minimise fuel use.
- O4 To encourage use of public transport services.

#### Controls

- C1 Council may require an Energy Efficiency Report to accompany all development applications for any new building.
- C2 Development applications may be exempt from the energy efficiency compliance certificate requirement where:
  - a) compliance conflicts with the conservation requirements of Babworth House; and
  - b) compliance conflicts with the desired future character for the site.
- C3 New residential buildings, where possible, include at least one north-facing room capable of use as a living area.
- C4 Windows to living areas, where possible, receive at least 3 hours of sun between 9am and 5pm on 21 June.
- C5 North-facing windows to living areas of neighbouring dwellings do not have sunlight reduced to less than 3 hours between 9am and 5pm on 21 June.
- C6 East facing windows are provided where possible for morning sunlight during winter months.

- 
- C7 Suitably screened external clothes drying areas with access to sunlight and breezes are available to all dwellings where possible.
  - C8 Buildings are sited and designed to provide solar access to living areas and principal areas of open space, having regard to slope, views, existing vegetation and overshadowing.
  - C9 Where possible, taking into account views, new buildings have an area of roof that is suitable for the installation of solar collectors and photovoltaic cells.
  - C10 Building materials and insulation that assist in providing acceptable thermal conditions are used wherever possible.
  - C11 Air movement by naturally ventilated systems within dwellings is encouraged, and should be designed to provide acceptable thermal conditions.
  - C12 Building materials, appliances and fuel sources are selected to achieve greater energy efficiency.
  - C13 Glazing to the west is avoided or otherwise treated by external screening devices (such as screens, pergolas and tree planting) to reduce summer heat load.

---

## G1.4.12 Water and soil management

---

Water and soil management on the site is required to ensure that the hydrological characteristics of the site and water quality of the harbor are not affected and soil erosion is avoided. Water management is also required to encourage the conservation and reuse of water.

### Objectives

- O1 To minimise changes to the hydrological characteristics of the site.
- O2 To prevent soil erosion.
- O3 To prevent pollution of the harbour from stormwater run-off.
- O4 To encourage water conservation and reuse.
- O5 To reactivate the historic drainage channels on the site and integrate them to the overall management system.
- O6 To control stormwater quality and quantity and eliminate discharge impacts on adjoining properties.
- O7 To ensure cost-effectiveness in the provision and maintenance of stormwater drainage works.
- O8 To reduce the pressure of new housing development on domestic water supplies.
- O9 To ensure building and landscape design incorporates techniques for conserving mains water.

### Controls

- C1 A stormwater and soil management plan is submitted with the masterplan application.
- C2 The stormwater and soil management plan demonstrates how runoff, sedimentation, erosion and groundwater flow is to be managed on the site.
- C3 Any development on the site minimises the extent of site clearing and earthworks.
- C4 Where excavation to a depth of more than 2m is proposed, Council will require the submission of a geotechnical report and a hydrological report as set out in the Woollahra Council Development Application Guide.
- C5 A stormwater drainage system is established onsite to control run-off and sediment during construction works.
- C6 Drainage and detention systems are designed to cater for a 100 year Average Recurrence Interval storm event.

- 
- C7 New drainage systems are designed to:
- a) incorporate historic channels (e.g. drainage channels along pathways) where possible;
  - b) store water for irrigation of landscaped areas through measures such as detention systems and rainwater tanks;
  - c) reduce overall town water usage on the site;
  - d) control the discharge to the harbor, including the quality of runoff;
  - e) provide a suitable level of protection to people and to property;
  - f) ensure that existing downstream systems are not adversely affected;
  - g) fit in with the hydrology of the natural system as much as possible;
  - h) consider the distribution of soil types and the scope for onsite filtration in areas where infiltration will not affect surrounding properties or contribute to slope instability or ground water pollution; and
  - i) retain significant trees.
- C8 Any inground drainage system incorporates measures for onsite water quality management and reuse.
- C9 Measures to reduce water consumption may include:
- a) rainwater tanks with direct plumbing to dwellings to reduce mains water consumption and minimise the amount of stormwater entering the drainage systems;
  - b) dual flushing toilets;
  - c) locating and grouping new plants;
  - d) irrigation systems that respond to the varying water needs of different sections of the garden; and
  - e) directing run-off from hard impervious surfaces to vegetation.
- C10 Overland flow path between Eastbourne Road and the harbour is provided. Such overland flow path is designed to control water depth and flow velocity in extreme rainfall events to Council's specified guidelines.
- C11 The existing Council drainage easement over the site is to be retained and the stormwater drainage line within the easement is to be upgraded if necessary. Council may consider the possible relocation of the easement and drainage line to another part of the site.



---

### G1.4.13 Safety and surveillance

---

Safety and surveillance provisions aim to use design to maximise personal security, reduce anxiety and fear, and maintain general safety and wellbeing within the local environment.

#### Objectives

- O1 To ensure a safe environment by promoting crime prevention through design.
- O2 To provide personal and property safety and surveillance for residents and visitors and enhance perceptions of community safety.

#### Controls

- C1 Buildings adjacent to public or communal streets or open space have at least one habitable room window with an outlook to that area.
- C2 Site planning, buildings, fence, landscaping and other features clearly define public, communal, semi-private and private spaces.
- C3 Buildings are designed to minimise access between roofs, balconies and windows or adjoining dwellings.
- C4 Pedestrian and vehicle thoroughfares are identified and reinforced as 'safe routes' through:
  - a) appropriate lighting;
  - b) casual surveillance from dwellings;
  - c) minimised opportunities for concealment;
  - d) landscaping which allows long-distance sight lines between buildings and the street; and
  - e) avoidance of 'blind' corners.
- C5 Lighting is provided to pedestrian ways, dwelling entries, high fences to the street, driveways and car parks to ensure a high level of safety and security at night. Such lighting may need to be shielded or hooded to minimise nuisance to neighbours.
- C6 Individual dwellings and entries are well lit and readily identifiable by visitors and emergency vehicles through clear house numbering and visibility.

---

### G1.4.14 Subdivision, maintenance and management

---

The maintenance of the estate, particularly the grounds, in a consistent manner will be affected by the ownership and management structure. Should the estate be split into multiple ownership a common management arrangement is strongly preferred.

A community title scheme, which comprises house lots and common areas, and may include strata lots, provides an ideal mechanism for the management of the estate as a whole. This form of subdivision is therefore recommended if there is to be multiple ownership of the site.

#### Objectives

- O1 To prevent fragmentation of the estate into disparate allotments bearing no apparent relationship to one another or to Babworth House and its grounds.
- O2 To ensure the site remains under a single management structure.
- O3 Where there are multiple owners, to provide joint responsibility for the maintenance of significant elements and common facilities and areas.
- O4 Where there are multiple owners, to share the maintenance costs burden and provide a consistent standard of estate management.

#### Controls

- C1 The masterplan application includes a notional plan of subdivision showing how the current titles will be amalgamated and re-subdivided under a common management structure. A community title scheme would be deemed suitable for a multiple ownership option.
- C2 A management agreement (as for example under the *Community Titles Act*) is submitted with any application for subdivision and addresses matters including, but not limited to:
  - a) ongoing care and maintenance of common areas and facilities;
  - b) conservation management of Babworth House and significant elements of the estate;
  - c) funding arrangements; and
  - d) insurances.

# Chapter G2

## Kilmory, 6 Wentworth Street, Point Piper

Part G ▶ Site-Specific Controls

CHAPTER G2 APPROVED ON 27 APRIL 2015  
AND COMMENCED ON 23 MAY 2015



# Chapter G2 ▶ Kilmory, 6 Wentworth Street, Point Piper

## Contents

<b>G2.1</b>	<b>INTRODUCTION .....</b>	<b>1</b>
	G2.1.1 Land where this chapter applies .....	2
	G2.1.2 Development to which this chapter applies.....	3
	G2.1.3 Objectives.....	3
	G2.1.4 How to use this chapter .....	3
	G2.1.5 Relationship to other parts of the DCP .....	4
	G2.1.6 Relationship to other documents .....	4
<b>G2.2</b>	<b>CHARACTER STATEMENT .....</b>	<b>5</b>
	G2.2.1 Existing character elements .....	5
	G2.2.2 Desired future character .....	5
<b>G2.3</b>	<b>PLANNING AND CONSERVATION PRINCIPLES .....</b>	<b>7</b>
	G2.3.1 Planning and conservation principles .....	7
<b>G2.4</b>	<b>DESIGN CRITERIA .....</b>	<b>8</b>
	G2.4.1 Heritage conservation.....	8
	G2.4.2 Site layout and views.....	12
	G2.4.3 Building design .....	17
	G2.4.4 Open space and landscaping .....	19
	G2.4.5 Fences and walls .....	23
	G2.4.6 Acoustic and visual privacy .....	24
	G2.4.7 Access and mobility .....	25
	G2.4.8 Car parking and driveways .....	26
	G2.4.9 Site facilities.....	29
	G2.4.10 Stormwater management .....	30
	G2.4.11 Safety and surveillance.....	32
	G2.4.12 Subdivision, maintenance and management .....	33
	G2.4.13 Construction and site management .....	35



## G2.1 Introduction

No. 6 Wentworth Street, Point Piper, known as Kilmory, is located on the north-eastern bend of Wentworth Street on the highest part of Point Piper. Because of this elevated position the building and its landscaped grounds can be seen from areas in Vaucluse, Rose Bay and Darling Point.

Kilmory is the largest site on the Point Piper peninsula and the last of that suburb’s grand estates. The property has exceptional local heritage significance and is listed as a heritage item in Woollahra Local Environmental Plan 2014 (Woollahra LEP 2014).

The house occupies a prominent and highly visible position on the site. From parts of Wentworth Street, it presents a striking and dominating form against an uninterrupted skyline. This elevated position also provides the house and the upper landscaped areas with expansive views of Sydney Harbour and the northern foreshore.

The house is an Arts and Crafts style building designed in 1913 by John William Manson of the architectural firm Manson and Pickering for Dr Alexander MacCormick (later Sir Alexander), an eminent member of Sydney’s medical profession. Construction of the house was undertaken by the leading building firm of Stuart Bros. Co. over the period 1913 to 1914.

The house and its landscape setting, including sandstone walling, driveway, entry posts and gates, elevated terraces, gardens and prominent trees are highly significant and contributory elements in the Wentworth Street streetscape.

Because of Kilmory’s heritage significance, its high streetscape value and the interest to redevelop the site, the Council decided to prepare site specific controls. The controls contained in this chapter are based on the Conservation Management Plan for Kilmory, 6 Wentworth Street Point Piper (January 1998 - issue F), which was adopted in part by the Council on 13 August 2001, and a set of conservation principles adopted by the Council on 12 August 2002.

Note: This chapter reflects the site specific development control plan adopted by Council on 16 December 2002, and which commenced on 23 December 2002.

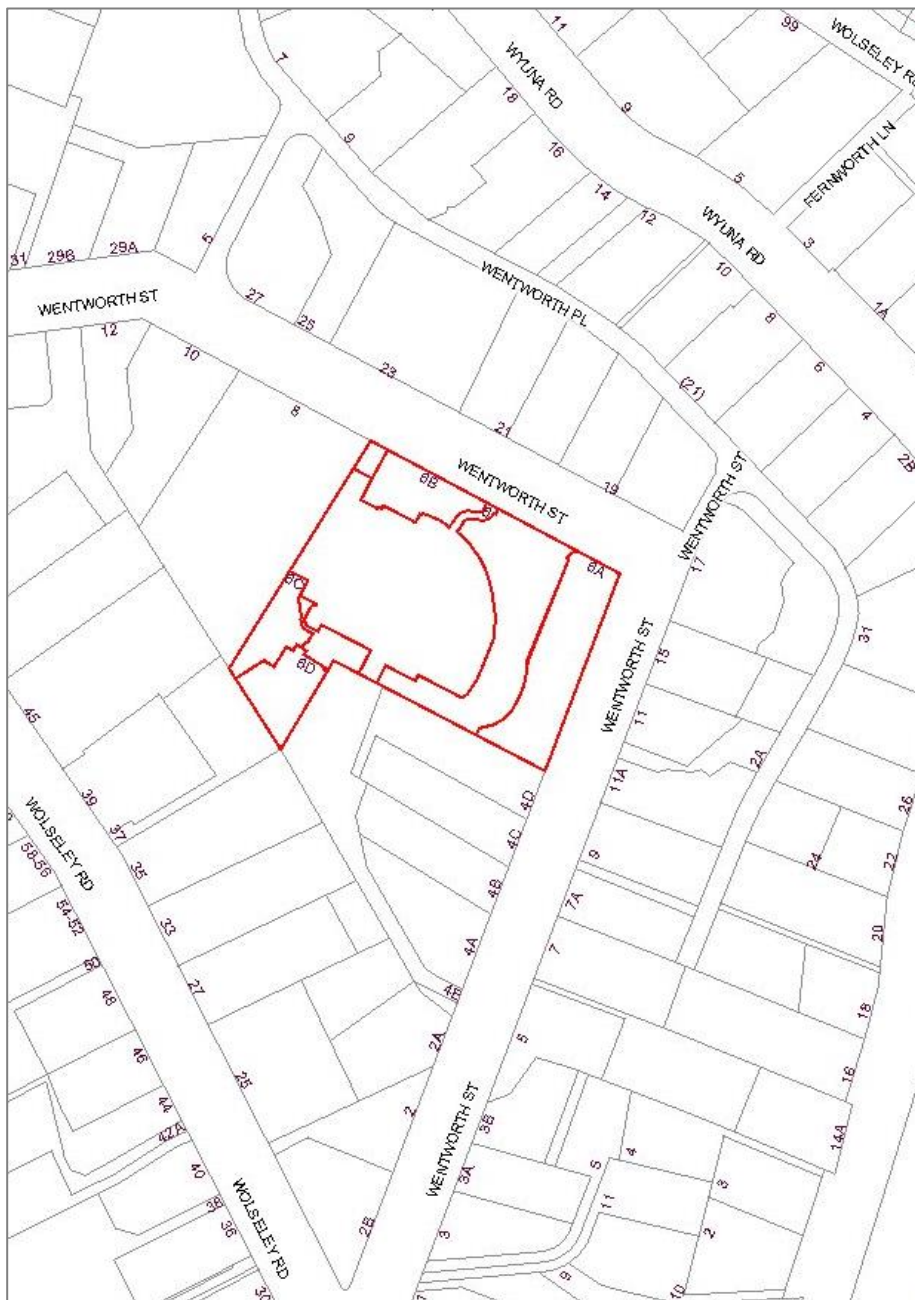


### G2.1.1 Land where this chapter applies

This chapter applies to No. 6, 6A, 6B, 6C and 6D Wentworth Street, Point Piper, being Lot 1-7 SP 77598 and Lot 3-6 DP 270495 (see Figure 1). The land is also known as Kilmory.

Note: For the purpose of this chapter, the whole of the site together with its built and natural elements is known as Kilmory. A reference in this chapter to Kilmory is intended to include a reference to all elements of the site. Objectives and controls may be provided for the whole site, for the house and for particular elements.

**FIGURE 1**  
Land where this chapter applies





---

### G2.1.2 Development to which this chapter applies

---

This chapter applies to development requiring consent under Woollahra LEP 2014.

### G2.1.3 Objectives

---

The objectives of this chapter are:

- O1 To conserve the heritage significance of Kilmory.
- O2 To provide planning and heritage conservation controls for Kilmory.
- O3 To encourage a high standard of architectural and landscape design in new development.
- O4 To maintain the visual setting of the house and the streetscape value of Kilmory.
- O5 To minimise the impact of new development on adjoining lands.
- O6 To encourage a single management structure for Kilmory.
- O7 To retain the outer subdivision boundaries of Kilmory.

Notes:

- ▶ Applicants must demonstrate in a statement of environmental effects and through the features of a proposal how development is consistent with the principle objectives of this chapter and the design criteria objectives.
- ▶ Council must not grant consent to the carrying out of development on the land to which this chapter applies unless it is of the opinion that the development would be consistent with the principle objectives of this chapter and the design criteria objectives.

### G2.1.4 How to use this chapter

---

This chapter is to be used primarily by:

- ▶ the property owners of Kilmory;
- ▶ applicants seeking consent for development on the site;
- ▶ Council's assessment officers; and
- ▶ Council's decision makers.

Applicants, in particular, must read all sections of this chapter in order to ensure that they:

- ▶ obtain an understanding of the chapter and its supporting and relating documents;
  - ▶ prepare and submit applications that contain the information necessary to meet the Council's requirements for development applications; and
  - ▶ prepare and submit applications that are consistent with the objectives, requirements, statements, principles and design criteria of the chapter.
-

---

Applicants must demonstrate in the statement of environmental effects that is submitted with a development application and through the features of the development proposal that the proposal is consistent with:

- ▶ the principle objectives of the chapter;
- ▶ the existing character elements of the site;
- ▶ the desired future character statement for the site;
- ▶ the planning principles for the site; and
- ▶ the design criteria objectives and design criteria for development.

### **G2.1.5 Relationship to other parts of the DCP**

---

This chapter is to be read in conjunction with the other parts of the DCP that are relevant to the development proposal, including:

- ▶ Part B: Chapter B1 Residential Precincts (Point Piper)
- ▶ Part B: Chapter B3 General Development Controls
- ▶ Part E: General Controls for All Development - this part contains chapters on Parking and Access, Stormwater and Flood Risk Management, Tree Management, Contaminated Land, Waste Management, Sustainability, Signage and Adaptable Housing.

In the event of any inconsistency between this chapter and the other chapters, this chapter prevails unless otherwise specified.

### **G2.1.6 Relationship to other documents**

---

#### **Conservation Management Plan**

Conservation Management Plan for Kilmory, 6 Wentworth Street, Point Piper (January 1998 - issue F), which was adopted in part by the Council on 13 August 2001, and a set of conservation principles adopted by the Council on 12 August 2002.

## G2.2 Character statement

### G2.2.1 Existing character elements

The existing character elements represent the distinguishing and important features of Kilmory. The existing character elements of Kilmory are:

- a) The dominant form and visual presence of the house as seen from Wentworth Street and from other locations, both local and distant.
- b) The landmark qualities of the site.
- c) The open appearance of the site which contrasts with the densely built up character of Point Piper.
- d) The distinctive and unifying use of sandstone in the boundary walls, garden terraces and house.
- e) The terraced landform rising from street level and terminating with the house.
- f) The uninterrupted form of the house, particularly the roof lines, against the skyline when viewed from Wentworth Street.
- g) The formal entrance gates and gate posts on Wentworth Street and the winding driveway, ascending to the house.
- h) The sweeping views of Sydney Harbour, Woollahra foreshores and the northern foreshore areas from the house and upper gardens.
- i) The individual elements of the house and its grounds that are of heritage significance as identified in the document titled Conservation Management Plan for Kilmory, 6 Wentworth Street Point Piper (January 1998 - issue F).
- j) The significant trees and vegetation.

### G2.2.2 Desired future character

Desired future character is a vision statement about the future image and function of Kilmory.

This chapter seeks to achieve a desired future character for Kilmory that:

- a) conserves the heritage significance of the house, its landscape setting and garden elements;
- b) maintains the landmark qualities of the house and its grounds;
- c) maintains the dominant form and visual presence of the house;
- d) maintains the 'grand estate' image of the site;
- e) maintains the open appearance of the site and the spatial relationship of the house with its garden setting;
- f) maintains the streetscape qualities of the house and grounds; and
- g) maintains the significant views from the house and its grounds.

**Notes:**

- ▶ Applicants must demonstrate in a statement of environmental effects and through the features of a proposal how development retains the existing character elements and achieves the outcomes expressed in the desired future character statement.
- ▶ The Council must not grant consent to the carrying out of development on the land to which this chapter applies unless it is of the opinion that the development would be consistent with the existing character elements and the desired future character of the site.
- ▶ Since the completion and approval of the conservation management plan, demolition of buildings on the site and within the house has occurred. Significant fabric within the house has been removed. The conservation management plan must be amended to reflect the demolition of buildings, to provide grades of significance for those parts of the site where buildings have been demolished, and to reclassify those spaces within the house where significant fabric has been removed.

---

## G2.3 Planning and conservation principles

Planning and conservation principles establish the fundamental planning rules for the site. These draw from the existing character elements and the desired future character statement. Along with the objectives of the chapter, the existing character elements and the desired future character statement, the planning and conservation principles establish a basis for the design criteria.

### G2.3.1 Planning and conservation principles

---

The planning and conservation principles applying to the site are:

#### Principle 1 - Research and investigation

Development of the site, irrespective of its intensity and form and including the use of the land, must be based on sound environmental planning and heritage conservation investigations and conclusions.

#### Principle 2 - Design

New development must demonstrate high quality architectural design that embraces conservation best practice.

Input to the design process from qualified and experienced professionals in the disciplines of architecture, heritage conservation, town planning and landscape architecture is essential.

#### Principle 3 - Conservation

Conservation of Kilmory as a whole is the primary outcome of all planning and development actions for the property. Conservation of the house in isolation does not satisfy this principle.

Conservation principles and practices set down in *The Burra Charter: the Australia ICOMOS Charter for Places of Cultural Significance 1999* (The Burra Charter) are adopted for the purpose of this chapter.

#### Principle 4 - Intensity of new development

The intensity of new development measured in terms of scale, form, location and quantity of new buildings is to be governed by matters including the impact on the heritage significance of Kilmory and the impact on adjoining lands (including public lands).

The intensity and type of development on neighbouring lands are not by themselves a justification for new development on Kilmory.

## G2.4 Design criteria

### G2.4.1 Heritage conservation

Kilmory is a property that has exceptional local heritage significance. The significance of the property has been documented in the Conservation Management Plan for Kilmory, 6 Wentworth Street Point Piper (January 1998 - issue F) and recognised through its listing as a heritage item in Woollahra LEP 2014. The conservation of Kilmory is the most important of the principle objectives of this chapter.

#### Notes:

Clause 2.3.5 of the *Conservation Management Plan for Kilmory, 6 Wentworth Street Point Piper* sets out the following summary statement of significance for Kilmory:

1. The property is of high local significance because it is one of the very few substantially intact estates in Point Piper with original Edwardian house and landscape intact on the early 1909 block subdivision and boundary which has been unaltered. It is a landmark property in Point Piper. The property has maintained significant views to Sydney Harbour, Rose Bay and Bondi.

It conveys the scale, detail and set up of a large Edwardian household.

The house is an important, rare and especially large example of the Arts and Crafts Style.

The property is important because of its prominent landmark setting. The house can be seen easily from many positions around the harbour in Point Piper.

2. Kilmory has historical associations with prominent figures in Sydney:
  - Sir Alexander MacCormick, a distinguished surgeon and entrepreneur; and
  - J.W.Manson a distinguished architect of the Edwardian period in Sydney.
3. Kilmory is associated with WWII and National Defence and accommodated staff of the Eastern Command.
4. A major institution for two orders of the Catholic Church in Australia:
  - The Jesuit Fathers, who established the Riverview Preparatory College.
  - The Franciscan Missionaries of Mary for their “Ave Maria” Retreat House.

Clause 2.3.4.1 of the *Conservation Management Plan for Kilmory, 6 Wentworth Street Point Piper* sets out an assessment of heritage values for Kilmory’s buildings, individual rooms and landscape elements.

Conservation is defined in The Burra Charter as “all the processes of looking after a place so as to retain its cultural significance.” Article 14 of The Burra Charter states:

“Conservation may, according to circumstance, include the processes of: retention or reintroduction of a use; retention of associations and meanings; maintenance, preservation, restoration, reconstruction, adaptation and interpretation; and will commonly include a combination of more than one of these.”

### Objectives

- O1 To conserve the heritage significance of Kilmory.
- O2 To ensure that all development, including works and uses, does not have a detrimental impact on the heritage significance of Kilmory.

### Controls

#### General

- C1 Land uses must respect the heritage significance of Kilmory. This may be achieved through uses that:
  - a) are sympathetic and consistent with the original use of Kilmory, which was a single residence;
  - b) involve or require minimal change to highly significant fabric and spaces;
  - c) do not adversely affect the heritage significance of Kilmory;
  - d) continue or reintroduce activities and practices that contribute to the significance of Kilmory;
  - e) provide options to allow long-term management and conservation of Kilmory as a whole rather than in a fragmented manner; and
  - f) retain the boundaries of Kilmory that define the curtilage of the house.
- C2 Original building fabric and landscape features must be recorded and conserved.
- C3 All conservation work must involve minimum interference to the existing fabric to minimise the loss of heritage significance.
- C4 Detrimental intervention may occur only in areas of little or moderate significance and the work must be reversible.
- C5 Fabric must be retained in situ unless moving it is the sole means of achieving its survival. It must be recorded to archival standards before disturbance occurs.
- C6 Removed fabric of heritage significance must be kept in a secure repository on site after cataloguing and recording.
- C7 Fabric must not be demolished or removed before the issue of a construction certificate.

- 
- C8 All development must comply in full with the detailed conservation policies 3.6.4 and 3.6.5 of the *Conservation Management Plan for Kilmory, 6 Wentworth Street, Point Piper, January 1998* issue F, by Tanner and Associates (pages 39-41).
- C9 The distinguishing and important features of Kilmory within the curtilage for the house must be conserved. This is to be achieved by complying with the controls within this chapter, particularly those for:
- a) site layout and views, especially those relating to protecting primary views and prohibiting buildings in landscape spaces of exceptional and high significance;
  - b) building design;
  - c) open space and landscaping;
  - d) fences and walls;
  - e) car parking and driveways;
  - f) site facilities; and
  - g) subdivision, maintenance and management.

#### **House**

- C10 Exceptional and highly significant fabric and spaces identified by the conservation management plan, are not to be damaged, destroyed or altered. Some change to areas of little or moderate significance may be permissible in order to accommodate any appropriate future use.
- C11 Reticulation of services must be carefully planned without causing damage to fabric or significant interior spaces.
- C12 New work must not detract from the heritage significance of the house and it must be reversible as far as practicable.

Note: The significance of individual rooms and elements in the house is identified in clause 2.3.4.1 of the *Conservation Management Plan for Kilmory, 6 Wentworth Street, Point Piper*.



---

### Heritage conservation incentives

Woollahra LEP 2014 provides for heritage conservation incentives for listed heritage items. The incentives may relate to the use of buildings and land (beyond those permissible under the land use zone), building works, floor space ratios and the provision of car parking.

The incentive provisions are subject to the Council being satisfied that certain outcomes will be achieved by the proposed development (see below).

In forming a view about a proposal's impact on heritage significance and the amenity of the neighbouring area the Council will take into consideration matters including:

- ▶ the relevant conservation provisions of Woollahra LEP 2014;
- ▶ objectives and controls in this chapter;
- ▶ other relevant DCP controls and requirements of other plans and policies that apply to the site; and
- ▶ section 79C of the *Environmental Planning and Assessment Act 1979*.

#### Notes:

- ▶ A statement of heritage impact prepared by a person qualified and experience in heritage conservation must accompany development applications. Guidelines for the preparation of statements of heritage impact can be found in the document produced by the NSW Heritage Office.
- ▶ The heritage impact statement must, as a minimum, describe:
  - the significance of the whole site and the individually significant spaces and elements of the house and grounds, including the landscape elements;
  - the impact of proposed development on that significance;
  - the measures that are proposed to mitigate the impact on significance;
  - the alternative development options that have been identified and why those options have not been pursued in order to achieve the conservation of Kilmory; and
  - how the proposed development will achieve the conservation of Kilmory.
- ▶ The Council will not grant consent to a development application relating to the land unless it has considered a statement of heritage impact.
- ▶ When a proposal seeks to use heritage incentives, the applicant must include within the statement of heritage impact:
  - evidence to demonstrate that all alternative options employing land uses permissible under the current zone for the site have been identified and examined; and
  - the reasons why those options have been discarded in favour of the proposed use.

---

## G2.4.2 Site layout and views

---

Site layout refers to the arrangement of buildings, spaces and access over the site. Site layout influences matters including views to and from the site, retention and protection of vegetation and open space, retention of significant site elements and impact on adjoining properties.

There are significant views to the house and grounds along Wentworth Street and from other areas.

### Objectives

- O1 To achieve a site layout that considers and respects the existing landscape character and heritage significance of the site.
- O2 To protect primary views to and from the site.
- O3 To provide a high level of amenity for future occupants of the site.
- O4 To maintain the amenity of neighbouring properties.
- O5 To protect primary views of the site's significant landscape elements and spaces as seen from within the site, from Wentworth Street and from other areas.

### Controls

#### General

- C1 The site layout must:
  - a) Retain and where possible enhance the important features of the site, including primary views (Figures 2 and 3), significant trees and vegetation (Figure 6), and landscape areas and elements of exceptional and high significance (Figure 4).
  - b) Relate building and landscape design to the site's contours and not involve:
    - large areas of excavation or landfill; or
    - new buildings, structures and landscape elements that block primary views.
- C2 New development, including planting, must not have a detrimental impact on the landmark qualities of Kilmory by blocking primary views of the house and significant landscape elements such as the sandstone terraces.
- C3 New buildings must not be located in the landscape areas of exceptional and high significance (Figure 4).
- C4 The building size and location controls in in Part B of this DCP, Chapter B3 General Development Controls apply to residential development on Kilmory excluding front setback, rear setback and building footprint requirements.

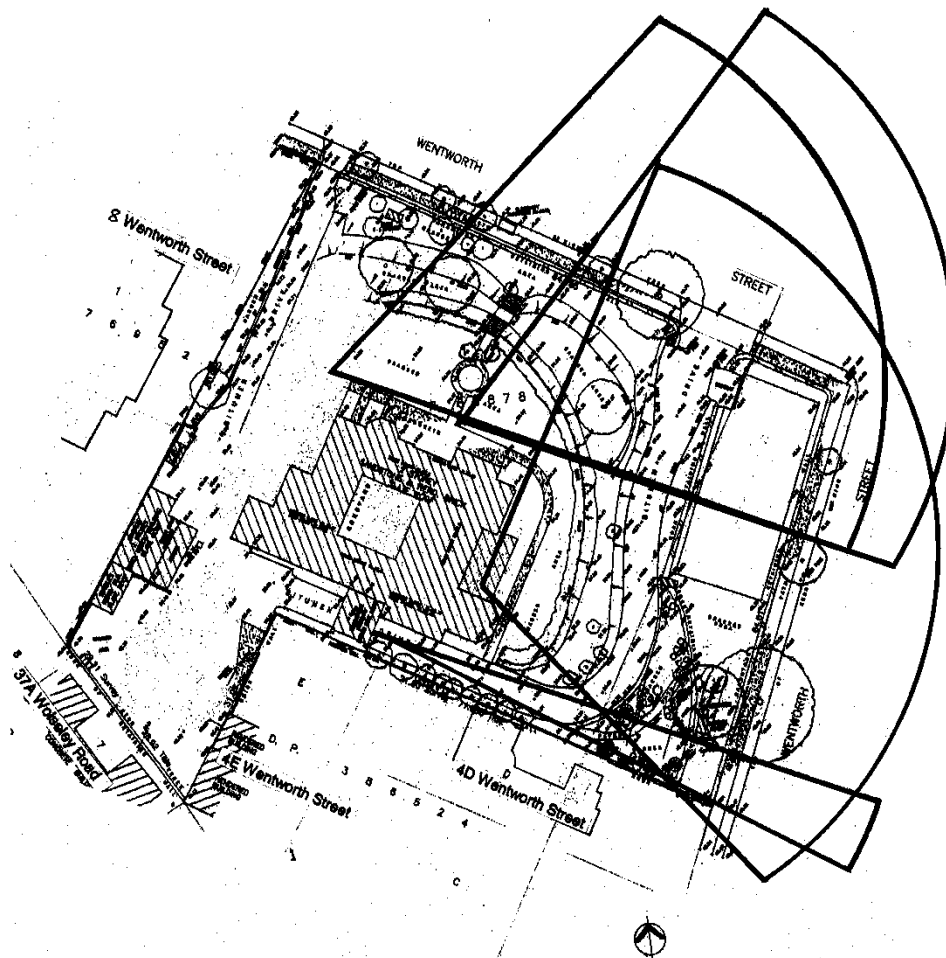
C5 Building footprints and setbacks:

- a) New development in the south-western corner, the south-eastern corner and adjoining the western elevation of the existing house must take place within the maximum building footprints and setbacks shown on Figure 5.
- b) All extensions to the existing house's western elevation must be setback from the principal external face of the existing building's northern elevation to allow views from Wentworth Street of the north-western corner of the existing building, particularly the gable end and archway.

Note: The principal external face of the northern elevation does not include the existing bay and gable projections.

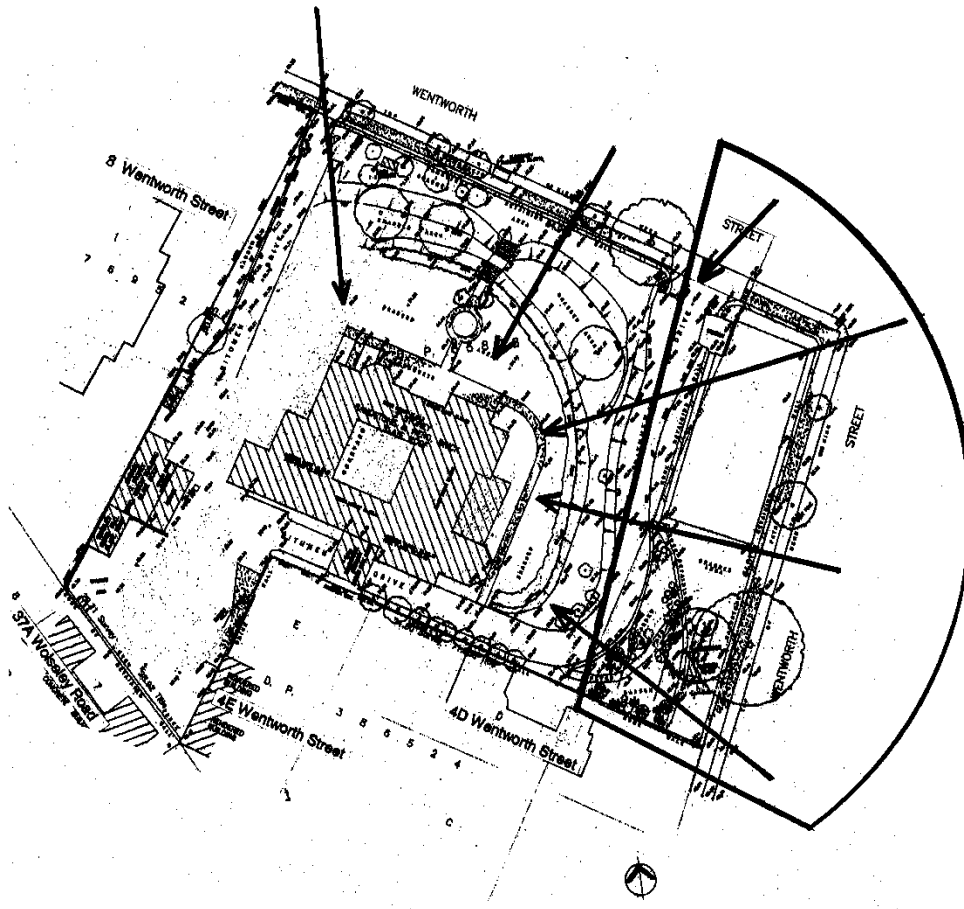
C6 Views to and from the house and from the northern garden area bounded by the Olea europea (Olive) hedge must be retained. In particular the views of the house and significant landscape elements and spaces from Wentworth Street must be retained.

**FIGURE 2**  
Primary views from Kilmory

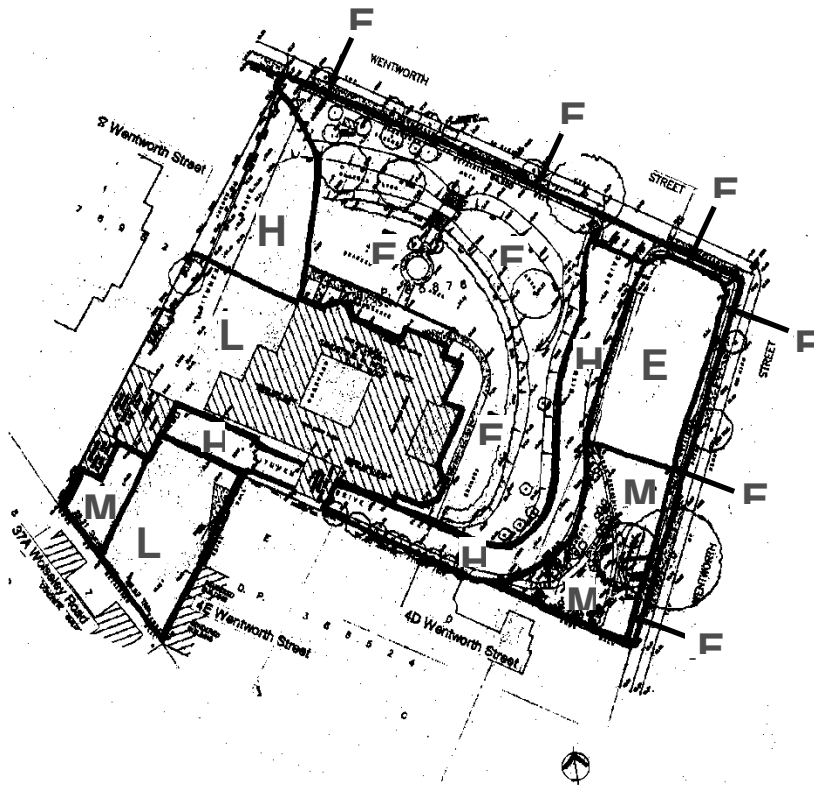


Note: Views are taken from upper garden area and from eastern ground floor verandah. Views take into consideration reduction of Olive hedge to a height of 1-1.2m.

**FIGURE 3**  
Primary views to Kilmory from Wentworth Street. Views over Kilmory from 4D Wentworth Street



**FIGURE 4**  
Landscape areas and elements of significance



Code	Significance value	Area and element
E	Exceptional	Eastern and northern sandstone boundary walls on Wentworth Street
E	Exceptional	Main sandstone gate posts and iron gates on Wentworth Street
E	Exceptional	Garden and landscape elements on northern and eastern side of house, including terracing, paths and sandstone steps (see Figure 6 for significant trees and vegetation)
E	Exceptional	Former tennis court area in north-eastern corner
H	High	Main driveway from Wentworth Street, including kerbs and gutters
H	High	Vacant area, former site of accommodation wing, north-western corner. A high significance value applies due to: <ul style="list-style-type: none"> <li>▶ the unbuilt nature of the area, which allows views to the house from Wentworth Street, and views from the house and adjoining garden area;</li> <li>▶ the proximity to the garden area which is of exceptional value; and</li> <li>▶ the potential to reinstate part of garden and terrace area.</li> </ul>
M	Moderate	Garden in south-eastern corner of site (see Figure 6 for significant trees)
M	Moderate	Vacant area, former drying yard, in south-western corner
L	Little	Vacant area, former site of 4 storey building, in southern part of site
L	Little	Vacant area, former site of accommodation wing, adjoining western side of house and south of the house's northern building line (see Figure 6 for significant trees)

Sources: Tanner and Associates Pty Ltd. Issue F/January 1998. Conservation Management Plan for Kilmory, 6 Wentworth Street Point Piper and Woollahra Council assessment



---

### G2.4.3 Building design

---

To maintain the heritage significance of Kilmory careful consideration must be given to the design of new work to the house and to all new buildings on the site. Good design is also essential for providing sustainable living environments and a high amenity for residents and other users of properties.

The form, scale and height of development and the type of materials and finishes are fundamental design elements. These elements set the character of buildings and influence the way in which new buildings respond to their natural and built context.

#### Objectives

- O1 To ensure that new development respects the form, scale, height and character of the existing house on Kilmory and does not detrimentally affect the significant elements on the site.
- O2 To encourage high quality contemporary design that is compatible with the heritage significance of Kilmory and the important character elements of the neighbourhood.
- O3 To retain principle views to and from the existing house and its significant landscape elements and spaces, especially from Wentworth Street.
- O4 To minimise excavation and landfill.
- O5 To provide a high level of amenity for future occupants.

#### Controls

##### *General*

- C1 Building height:
    - a) The maximum height of new development must not exceed the height controls under Woollahra LEP 2014. The maximum height will not be achievable where:
      - proposed buildings would impact on primary views to and from the existing house;
      - the scale of proposed buildings would, individually or collectively, compete with the scale of the existing house;
      - proposed buildings would not satisfy the objectives of the height standard; and
      - in addition, new development labelled B1, B2 and B3 on Figure 5 must not exceed 2 storeys in height.
  - C2 The scale of new development, including additions to the house and works in the grounds, must be substantially subservient to the scale of the existing house.
  - C3 New building work, including additions to the house and works in the grounds, must incorporate design elements that complement, but do not mimic the architectural character of the existing house, through:
    - a) compatible, but distinctly lesser massing, scale and height;
-

- 
- b) similar roof forms (when visible);
  - c) similar proportions and solid-to-void ratios of openings for windows and doors; and
  - d) compatible materials, finishes and colours.
- C4 The large expanses of walls on new buildings must be broken by articulation, modelling, window openings and similar features.
- C5 In order to maintain the visual dominance and character of the existing house, new buildings must display less articulation and diversity than found in the existing house.
- C6 Acceptable materials, finishes and colours include:
- a) rendered masonry for walls;
  - b) traditional roof finishes such as lead, zinc, sheet copper or slate or its modern equivalent; and
  - c) restrained colour schemes that are sympathetic to the external colours of the existing house.
- C7 Mirrored or other highly reflective materials (with a reflectivity of 15%) must not be used on building exteriors.
- C8 Buildings must have a good thermal mass by using materials such as concrete slab floors, cavity brick, concrete block and stone walls.

### *House*

- C10 The visual prominence and symbolic significance of the house within its setting must be retained, especially in the context of Wentworth Street.
- C11 The appearance of the house as a single, two storey residence with intact roof planes to the north and east must be retained.
- C12 The existing northern and eastern roof planes, including those over bay projections and gables, must not be altered by dormers, skylights, vents, aerials or by similar or other elements whether projecting, recessed or flush with the roof planes.

### Notes:

- ▶ When major development is proposed to the existing house or within the grounds, or both, the applicant must submit a design statement with the development application. In the design statement the applicant must demonstrate that the proposed design through the design idiom, scale, massing, materials, detailing and construction techniques appropriately responds to the heritage significance of Kilmory and the neighbourhood's desired future character.
- ▶ With any development involving new structures and landscaping works within the grounds of Kilmory, the applicant must provide view line diagrams to illustrate the impact on the views and vistas to and from:
  - the house; and
  - the significant landscape elements and spaces of the site.



---

### G2.4.4 Open space and landscaping

---

Kilmory contains numerous landscape elements that are of individual significance and that contribute to the site's overall significance. These include the sandstone entrance wall, sandstone posts and iron gates on Wentworth Street, the driveway, and the garden area on the northern side of the house.

High quality landscape design is important for a number of reasons. It will integrate the significant landscape elements and the house with new development and new landscape features. It will also contribute to the amenity of the area and the streetscape.

#### Objectives

- O1 To allow conservation and interpretation of the significant landscape elements.
- O2 To retain significant trees, vegetation and other landscape elements.
- O3 To provide an adequate amount of usable open space.
- O4 To ensure that an integrated landscape concept for the site is employed.
- O5 To ensure that new landscape features do not reduce views to and from the site.
- O6 To facilitate and improve stormwater management.
- O7 To enhance the appearance, amenity and energy efficiency of housing through integrated landscape design.

#### Controls

- C1 Landscape design must demonstrate through the use of plant species, hard landscape elements and materials that an appropriate response to the heritage significance of Kilmory's garden and landscape has been achieved.
- C2 Sandstone boundary walls, terraces, sandstone retaining walls, gate posts and iron gates, and sandstone kerbs and gutters must be retained and conserved.
- C3 Existing pathways and sandstone steps must be retained.
- C4 Significant trees and vegetation must be retained (Figure 6).  
Note: Council consent is required for any tree works affecting trees or other vegetation that are prescribed under the Woollahra DCP.
- C5 The existing *Olea europea* (Olive) hedge must be retained and pruned to a height that allows views in a northern and eastern direction from the upper garden level.

- 
- C6 New pedestrian accessways are to be designed with regard to:
- minimising the impact on significant spaces and landscape elements;
  - protecting significant trees and vegetation;
  - enhancing the landscape setting and character of Kilmory;
  - meeting access requirements for older people and people with a disability; and
  - providing privacy and security for new and existing development and neighbouring properties.
- C7 The open space and landscaping controls in Part B of this DCP, Chapter B3 General Development Controls Section 3.7.1 (Landscape areas and private open space) apply to development for the purpose of residential development on Kilmory with the exception of C5 and C12.
- C8 In the case of residential development other than a dwelling house, each dwelling must have private open space with:
- at least two hours of sunlight per day in mid-winter;
  - a minimum area of 25m<sup>2</sup> for dwellings of 2 or more bedrooms;
  - a minimum dimension of 2m; and
  - direct access from a living area of the dwelling.
- C9 Private open spaces must be located so that they provide surveillance and privacy in cases where they adjoin communal open spaces.
- C10 Methods of delineating private and communal open space must involve landscape features such as hedges, planting beds and changes in level. Fencing within the site is not acceptable, except for safety reasons such as pool fences, or for a tennis court.
- C11 A lightweight retractable net must be provided around the tennis court.
- C12 Tennis court lighting is not allowed.

### **House**

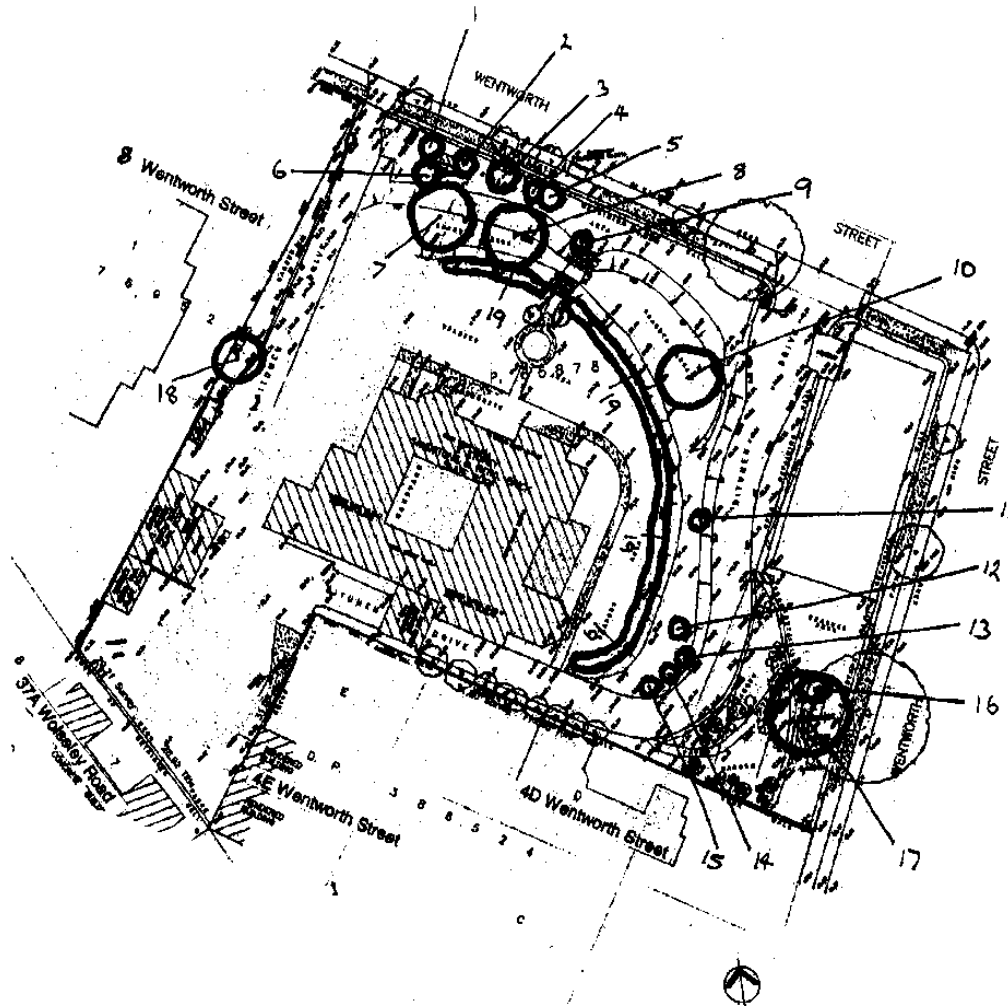
- C13 New planting and landscape elements must not reduce views to and from the house, especially from the Wentworth Street context.

### **Notes:**

- ▶ When major development is proposed for the grounds of Kilmory a detailed landscape plan must be provided with the development application and must be approved by the Council.
  - ▶ A landscape plan, prepared by a landscape consultant qualified and experienced in historic gardens, must accompany the development application and include:
    - a description and plan of the significant landscape zones and elements;
    - an arborist's report on the condition of all significant trees and vegetation and all trees proposed for removal;
-

- a plan for the restoration and reconstruction of significant landscape zones and elements which is consistent with the heritage significance and character of Kilmory’s garden;
- plant species to be retained and removed;
- details of new work including:
  - location of proposed lighting
  - watering and irrigation systems
  - drainage and stormwater management
  - new plants, paths and stairs
  - location of private open space facilities
  - location of communal open space and facilities (where multiple occupancy is proposed)
  - methods of delineating private and communal open space and facilities; and
- other relevant matters identified by the Council’s officers during pre-DA discussions.

**FIGURE 6**  
Significant trees and vegetation



No.	Botanical name	Common name	No.	Botanical name	Common name
1	Camellia sp.	Camellia*	11	Cupressus spp	Cypress Pine
2	Camellia sp.	Camellia*	12	Camellia sp.	Camellia
3	Camellia sp.	Camellia*	13	Cupressus spp	Cypress Pine
4	Camellia sp.	Camellia*	14	Cupressus spp	Cypress Pine
5	Plumeria acutifolia	Frangipanni	15	Cupressus spp	Cypress Pine
6	Archontophoenix alexandrae	Alexander Palm*	16	Howea forsteriana	Kentia Palm*
7	Araucaria heterophylla	Norfolk Island Pine	17	Glochidion ferdinandii	Cheese Tree
8	Ficus rubiginosa	Port Jackson Fig	18	Gordonia axillaris	Gordonia
9	Camellia sp.	Camellia*	19	Olea europea	Olive
10	Cinnamomum camphora	Camphor Laurel			

\* Denotes may be transplanted within the site

Source: Woollahra Council assessment

---

### G2.4.5 Fences and walls

---

Kilmory's northern and eastern sandstone boundary walls are significant heritage elements and also make significant contributions to the streetscape of Wentworth Street.

The walls provide security for the property and at their existing height do not interrupt primary views to the house and its landscape setting.

#### Objectives

- O1 To conserve the significant sandstone boundary walls on Wentworth Street.
- O2 To retain primary views to the house and its landscape setting from Wentworth Street.
- O3 To retain the significant contribution made by the existing northern and eastern sandstone boundary walls to the streetscape of Wentworth Street.
- O4 To ensure that new fencing on the southern and western boundaries is compatible with the heritage significance of Kilmory.
- O5 To ensure that new fencing on the southern and western boundaries provides adequate privacy and security for Kilmory and for adjoining properties.

#### Controls

- C1 Sandstone boundary walls on Wentworth Street must be retained and conserved.
- C2 The height of the sandstone boundary walls on Wentworth Street must not be increased.
- C3 New fencing on the southern and western boundaries must not exceed 1.8m in height where the site is level with the adjoining site, or 1.8m measured from the low side where there is a difference in level either side of the boundary.
- C4 Fencing within the site is not permitted, except for pool fencing or fencing for a tennis court.
- C5 Methods of delineating private and communal open space must involve landscape features such as hedges, planting beds and changes in level.
- C6 Tennis court fencing associated with a court in the north-eastern corner of the site is to be designed and constructed so that it can be lowered below the existing height of the Wentworth Street boundary wall.
- C7 No openings are allowed in the existing sandstone boundary walls on Wentworth Street except for a new garage opening in the south-western corner (Figure 7) and a single pedestrian gate on the northern boundary wall, if required.
- C8 The fences and walls controls in Part B of this DCP, Chapter B3 General Development Controls Section 3.7.2 (Fences) do not apply to residential development on Kilmory with the exception of C7 and C15.

---

### G2.4.6 Acoustic and visual privacy

---

Visual and acoustic privacy are important factors in the amenity of a place, particularly for residential uses. Kilmory is located in a dense residential area and is adjoined on two sides by residential development of mixed intensity. Acoustic and visual privacy needs of both future residents of Kilmory and neighbouring development will require sensitive and careful design.

#### Objectives

- O1 To protect the acoustic and visual privacy of neighbouring development.
- O2 To provide adequate acoustic and visual privacy for future residents of Kilmory.

#### Controls

- C1 The acoustic and visual privacy controls in Part B of this DCP, Chapter B3 General Development Controls Section 3.5.4 (Acoustic and visual privacy) apply to residential development on Kilmory.
- C2 Trees and other vegetation can be used on the southern and western boundaries to provide acoustic and visual privacy.
- C3 Existing vegetation on the southern and western boundaries must be retained and supplemented if necessary.

### G2.4.7 Access and mobility

---

Access and mobility provisions are necessary so that development is accessible and able to be used by all members of the community.

The provisions are principally directed towards eliminating barriers to people with a disability and older people and are intended to complement the access controls in this DCP (refer to Part E Chapter E8 Adaptable Housing) .

Because of the heritage significance of the site, access provisions require special consideration at the design stage.

#### Objectives

- O1 To ensure that new buildings, associated spaces and any communal areas are accessible, usable or adaptable for all people in the community, including people with a disability and older people.

#### Controls

- C1 The access and mobility controls in Part E of this DCP, General Controls for All Development, apply to development for the purpose of dwelling houses and multiple dwellings on Kilmory.

### G2.4.8 Car parking and driveways

Provision of on-site parking and driveways for Kilmory needs to be carefully planned and introduced so that there are minimal impacts on the heritage significance of the house and landscape elements and minimal disturbances to the existing landform. For these reasons special parking requirements are provided for Kilmory. These requirements are different to those normally required for dwelling-houses and residential flat buildings.

#### Objectives

- O1 To maintain the heritage significance of Kilmory.
- O2 To ensure that on-site parking and driveways do not dominate the landscape setting of Kilmory.
- O3 To maintain the amenity of adjoining properties.
- O4 To minimise the impact of car parking facilities and driveways on the streetscape of Wentworth Street.
- O5 To provide convenient and safe car parking and access for residents and visitors.
- O6 To limit site excavation and changes to the landform of Kilmory.
- O7 To minimise stormwater runoff.

#### Controls

- C1 The car parking and driveway controls in Part B of this DCP General Development Controls, Chapter B3 Section 3.6 (On-site parking) and Chapter E8 (Parking and Access) apply to development for the purpose of dwelling houses and multiple dwellings on Kilmory except where inconsistent with the controls in this chapter.
- C2 Proposals for new dwellings on the grounds of Kilmory, or for the creation of separate dwellings in the existing house, or both, must provide on-site parking to meet the requirements outlined in the following table.

Dwelling size	Maximum number of spaces per dwelling
1 bedroom	1
2 bedrooms	1.5
3 or more bedrooms	2
Visitors	0.25

Note: Spaces are to be rounded to the nearest whole number.

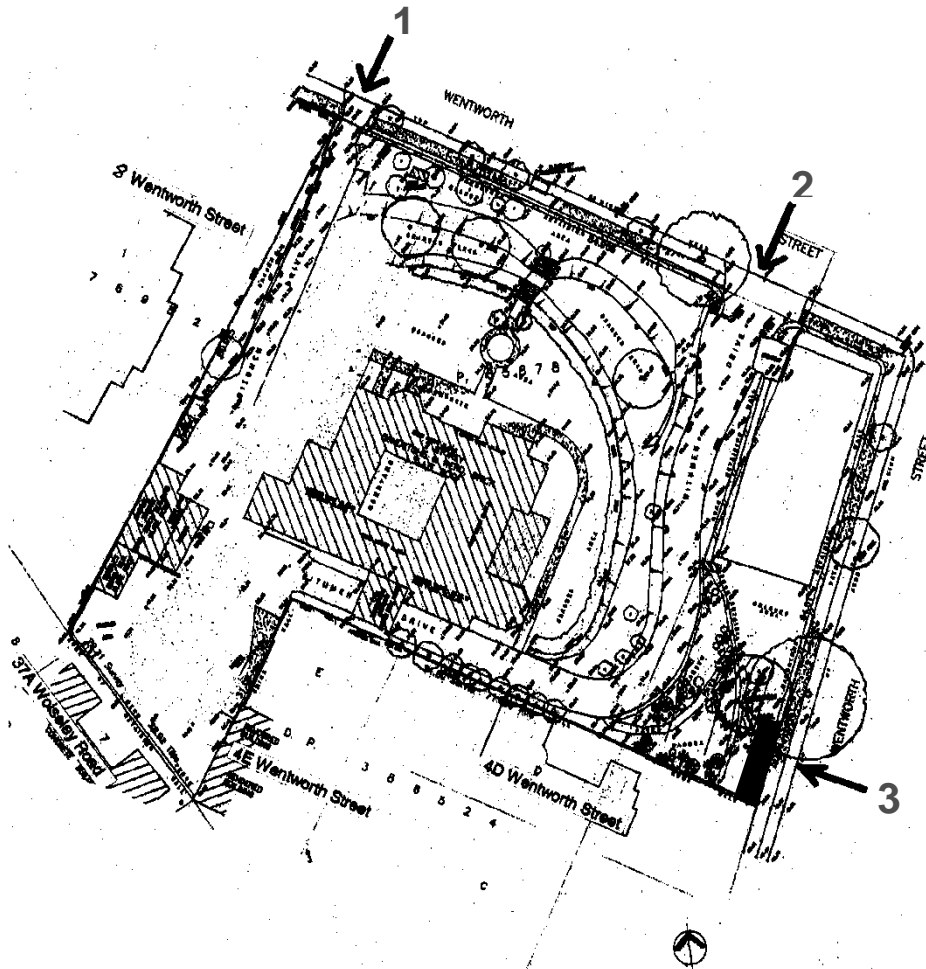
- C3 Where Kilmory is used for the purpose of a dwelling-house, two on-site parking spaces must be provided.



- 
- C4 For uses other than those stated in C2 and C3 or where variations to the rates set out in the table to C2 are sought, the Council will consider parking provision on its merit and in light of matters including:
- a) the impact on the heritage significance of Kilmory;
  - b) the impact on the streetscape of Wentworth Street;
  - c) the extent of any excavation and the impact on the landform of Kilmory and the provision of deep soil landscaping; and
  - d) the effect on the bulk, scale and form of new development.
- C5 The area of site excavation for the purposes of underground car parking is to be substantially limited to the building footprint of new buildings for which parking is required. In order to protect the significance of the existing house, excavation for the purpose of car parking underneath the footprint of the existing house should not occur.
- C6 Car parking and driveways must be designed and located to:
- a) conserve the heritage significance of Kilmory;
  - b) maintain views to and from the house;
  - c) maintain significant trees and vegetation;
  - d) provide convenient and safe access to all buildings;
  - e) prevent traffic conflicts;
  - f) minimise excavation and changes to the landform of Kilmory;
  - g) integrate physically and visually with the landform and built elements;
  - h) enable the efficient use of car spaces and accessways, including safe manoeuvrability for vehicles between the site and Wentworth Street;
  - i) allow vehicles to enter and leave the site in a forward direction;
  - j) minimise impacts on adjoining properties in regard to matters including noise and vehicle headlights; and
  - k) minimise the visual dominance of parking areas, structures and accessways.
- C7 Open car parking spaces must be designed, surfaced and graded to facilitate on-site stormwater management set out in a stormwater and soil management plan for Kilmory.
- C8 Resident parking must be concealed.
- C9 Vehicle entry and exit points are restricted to:
- a) the existing points on the northern boundary of the site; and
  - b) a new point in the south-eastern corner of the site, if required (see Figure 7).
- C10 The sandstone gate posts, gates, and associated sandstone walls in the north-eastern corner of the site must be retained and conserved in their existing location, form and configuration.
- C11 The existing driveway must be retained and resurfaced with an appropriate pervious surface.
- C12 Adequate parking and manoeuvrability must be provided for service vehicles.
-

**FIGURE 7**  
Vehicle entry and exit points

- 1. Existing secondary
- 2. Existing main
- 3. Possible future secondary



### G2.4.9 Site facilities

---

Residential development requires site facilities such as mail boxes, garbage collection areas and clothes drying areas. Careful consideration to the location and treatment of these facilities can improve the amenity of occupants and mitigate potential adverse visual and odour impacts on adjoining properties.

The impacts of site facilities on the appearance of the existing house, its grounds and the streetscape need to be considered.

#### Objectives

- O1 The objectives for site facilities in Part B General Residential apply to residential development on Kilmory.

#### Controls

- C1 The controls for site facilities in Part B of this DCP, Chapter B3 General Development Controls, Section 3.7.3 (Site facilities) apply to residential development on Kilmory.
- C2 All site facilities must be designed so that they can be used by people with a disability and older people.
- C3 Satellite dishes must not be visible from the street.

---

### G2.4.10 Stormwater management

---

Stormwater management is particularly important and necessary for heritage properties due to the potential damage that can be caused to significant fabric and spaces by water penetration, flooding and erosion. The elevated topography and terraced landform of Kilmory also create particular issues for water run-off.

Because of Kilmory's proximity to Sydney Harbour, stormwater management is essential to ensure that water quality of the harbour is not affected.

#### Objectives

- O1 To protect the fabric of the house and the significant landscape elements of Kilmory.
- O2 To minimise changes to the hydrological characteristics of Kilmory.
- O3 To prevent soil erosion.
- O4 To reduce pollution of Sydney Harbour from stormwater run-off.
- O5 To encourage water conservation and reuse.
- O6 To ensure that the historic drainage channels on the site operate effectively and are integrated with new stormwater management facilities.
- O7 To control the quantity and quality of stormwater run-off.
- O8 To minimise stormwater run-off impacts on adjoining and neighbouring lands.
- O9 To reduce the pressure of new development on domestic water supplies.
- O10 To ensure that building and landscape design incorporate techniques for conserving mains water.

#### Controls

- C1 The stormwater management controls in Part E of this DCP, Chapter E2 Stormwater and Flood Risk Management apply to residential development on Kilmory.
- C2 Development should involve minimal site clearing and earthworks.
- C3 Drainage and detention systems must be designed to cater for a 100 year Average Recurrence Interval storm event.
- C4 New drainage systems must be designed to:
  - a) incorporate the effective historic drainage channels of Kilmory;
  - b) store water for irrigation of landscaped areas;
  - c) reduce overall mains water usage on the site;
  - d) control the quality of drainage discharge to Council's drainage system;

- e) ensure that existing systems are not adversely affected;
- f) fit in with the hydrology of the natural system as much as possible;
- g) retain significant trees and vegetation; and
- h) allow for maximum on-site infiltration but subject to:
  - underlying geological conditions
  - the stability of the site
  - the impact of infiltration on the fabric of the house and significant landscape elements
  - the impact of infiltration on adjoining properties.

Notes:

- ▶ Where major development is proposed for the house or the grounds, or both, a stormwater and soil management plan must be lodged with the development application and approved by the Council in conjunction with a consent for the application. The plan must demonstrate how run-off, sedimentation, erosion and groundwater flow is to be managed on the site.
- ▶ Where excavation to a depth of more than 2m is proposed, a geotechnical and hydrogeological report must be provided with the development application.

---

### G2.4.11 Safety and surveillance

---

Safety and surveillance provisions can maximise personal security, reduce anxiety and maintain general safety and well-being within the local environment.

#### Objectives

- O1 To ensure a safe environment by promoting crime prevention by design.
- O2 To ensure personal and property safety and surveillance for residents and visitors.

#### Controls

- C1 Where new dwellings are proposed in the grounds:
  - a) windows or balconies are to be provided in external walls to habitable rooms adjacent to open spaces; and
  - b) individual dwellings must be designed to minimise access between roofs, balconies, windows and adjoining dwellings.
- C2 Shared and private dwelling entries must be well lit, visible and readily identifiable by visitors and emergency personnel.
- C3 Site planning must clearly define communal and private open space areas through distinct landscape features. Fencing is not to be used for this purpose other than on the extreme boundaries of the site.
- C4 Pedestrian accessways must be identified as safe routes through:
  - a) appropriate lighting;
  - b) casual surveillance from dwellings;
  - c) minimised opportunities for concealment;
  - d) landscaping that allows long-distant sight lines between buildings and the street; and
  - e) avoidance of blind corners.
- C5 Lighting must be provided to pedestrian accessways, dwelling entries, driveways and car parks to ensure a high level of safety and security at night. Such lighting may need to be shielded or hooded to minimise nuisance to neighbouring properties.

---

### G2.4.12 Subdivision, maintenance and management

---

The maintenance and management of Kilmory in a consistent manner is critical to its conservation. Issues of land subdivision and land tenure are extremely influential in management practices and outcomes. The current land boundaries of Kilmory define the estate. These boundaries have remained intact since 1909 and are highly significant elements of Kilmory.

Under the NSW land title system there are numerous options that can be used for Kilmory depending on the nature of development.

#### Objectives

- O1 To prevent fragmentation of Kilmory into disparate allotments.
- O2 To ensure that the site remains under a single management structure.
- O3 To ensure that responsibility for management and maintenance of Kilmory is shared fairly and reasonably where the site is under multiple ownership.
- O4 To ensure that a consistent standard or estate management occurs.

#### Controls

- C1 The boundaries of Kilmory as defined by Lot 1, Deposited Plan 65878 should not be altered.
- C2 Subdivision of the land is not preferred.
- C3 The property should remain under single title.
- C4 In the case where subdivision is proposed:
  - a) a community title scheme would be suitable for a multiple ownership option and
  - b) delineation of boundaries by fencing is not acceptable. Allotment boundaries can be delineated by landscape features such as hedges, planting beds and changes in level. Fencing within the site is not acceptable, except for safety reasons such as pool fences and for a tennis court.

#### Notes:

- ▶ The Council must not grant consent to an application for subdivision unless it is satisfied that adequate arrangements are in place or will be put into place for:
  - the funding and implementation of conservation works; and
  - the provision of ongoing maintenance, to ensure the ongoing conservation of Kilmory.
- ▶ Where subdivision is proposed, a management plan, such as one provided under the Community Titles Act, must be submitted with the application for subdivision and approved by the Council. The plan must address matters including:
  - ongoing care and maintenance of common areas and facilities, including communal open space areas;

- conservation management of the house and other significant elements of the estate;
  - funding arrangements for conservation of the house and grounds; and
  - insurances.
- ▶ When major development or a new land use, or both, are proposed, a decision making procedure must be submitted with the application and approved by the Council. Professionals with appropriate levels of conservation skills and experience must be engaged to provide advice in the decision-making process. The procedure must be approved by Council prior to commencement of any work. Appropriate direction and supervision by suitably qualified and experienced professionals must be maintained at all stages of works. Records must be kept of findings and decisions. Copies of all catalogued fabric, reports and records must be placed in a permanent archive such as the Woollahra Local History Library and made publicly available.



---

### G2.4.13 Construction and site management

---

Because of the heritage significance of Kilmory, adequate consideration is required at the design stage of the manner in which construction is staged and the way in which construction vehicles, machinery and facilities enter, move around and leave the site.

#### Objectives

- O1 To minimise the adverse impact of the movement of construction vehicles, machinery and facilities on the heritage significance of Kilmory and the amenity of the neighbourhood.
- O2 To ensure that construction vehicles access into and from Kilmory is safe and does not create vehicle and pedestrian conflict.

#### Controls

- C1 When a major development is proposed for Kilmory a construction management plan must be submitted with the development application and approved by Council.

Note: A construction management plan for major development must include the following information:

- ▶ proposed movement of construction vehicles, equipment and facilities to, from and within Kilmory;
- ▶ phases of construction;
- ▶ types of vehicles, equipment and facilities to be used throughout the construction;
- ▶ periods and times during the construction when movement to and from Kilmory will occur;
- ▶ steps that are to be taken to mitigate adverse impact on the heritage significance of Kilmory, the amenity of neighbouring properties and on-street parking; and
- ▶ location of materials and machinery stores on Kilmory.

**Chapter G3**  
**Hawthornden,**  
**6-12 Roslyndale Avenue, Woollahra**

Part G ▶ Site-Specific Controls

CHAPTER G3 APPROVED ON 27 APRIL 2015  
AND COMMENCED ON 23 MAY 2015



# Chapter G3 ► Hawthornden, 6-12 Roslyndale Avenue, Woollahra

## Contents

<b>G3.1</b>	<b>INTRODUCTION .....</b>	<b>1</b>
	G3.1.1 Land where this chapter applies .....	1
	G3.1.2 Development to which this chapter applies.....	1
	G3.1.3 Objectives.....	1
	G3.1.4 Relationship to other parts of the DCP .....	2
	G3.1.5 Relationship to other plans and documents.....	2
	G3.1.6 Decision-making criteria.....	2
	G3.1.7 Conservation outcomes .....	3
<b>G3.2</b>	<b>THE CULTURAL SIGNIFICANCE OF THE SITE .....</b>	<b>4</b>
	G3.2.1 Statement of significance .....	4
	G3.2.2 Rankings of significance .....	5
<b>G3.3</b>	<b>THE CURTILAGE FOR THE SITE .....</b>	<b>10</b>
<b>G3.4</b>	<b>CONSERVATION POLICY FOR THE SITE.....</b>	<b>11</b>
	G3.4.1 The conservation policy: general principles .....	11
	G3.4.2 The existing house .....	12
	G3.4.3 Other site elements .....	12
	G3.4.4 Implementation of the conservation policy .....	13
<b>G3.5</b>	<b>SPECIFIC DEVELOPMENT CONTROLS .....</b>	<b>14</b>
	G3.5.1 Subdivision .....	14
	G3.5.2 The dwelling .....	14
	G3.5.3 Heights.....	15
	G3.5.4 External materials, colours and finishes.....	16
	G3.5.5 Garden elements, landscaping and management of significant vegetation .....	16
	G3.5.6 Protection of viewsheds .....	17
	G3.5.7 Future development in the grounds .....	18
	G3.5.8 Pedestrian and vehicular access and parking .....	19
	G3.5.9 Conservation incentives relating to heritage items.....	19
<b>G3.6</b>	<b>REQUIREMENTS FOR DEVELOPMENT APPLICATIONS AFFECTING THE SITE .....</b>	<b>20</b>
	G3.6.1 Preparatory steps .....	20
	G3.6.2 Minor development .....	20
<b>APPENDIX 1</b>	<b>- CURTILAGE OF THE SITE .....</b>	<b>21</b>
	Background.....	21
	History of development .....	21
	Methodology for determining a curtilage .....	22
	Conclusion.....	25

**APPENDIX 2 - CONSERVATION POLICY: CONSTRAINTS..... 26**  
Constraints arising from the statement of significance ..... 26  
Constraints arising from the Burra Charter..... 26  
Constraints arising from the physical circumstances of the site ..... 27

## G3.1 Introduction

This chapter applies to the place known as *Hawthornden*, situated at 6-12 Roslyndale Avenue, Woollahra, which is listed on the Heritage Schedule to the Woollahra Local Environmental Plan 2014 (Woollahra LEP 2014).

Conservation is the process of retaining these significant qualities. It generally aims at preserving as much as possible of the original fabric and setting of the heritage item or place. This chapter lays down Council's requirements for the conservation of Hawthornden and the assessment of any proposals for future development or use of the site.

Note: This chapter reflects the site specific development control plan adopted by Council on 25 November 1996, and which commenced on 4 December 1996.

### G3.1.1 Land where this chapter applies

The land to which this chapter applies is situated at 6-12 Roslyndale Avenue, Woollahra, being Lot 100, DP738428.

The dwelling house, known as Hawthornden, the gardens, gate posts, gates, and Bunya Pine are listed as heritage items in the schedule to Woollahra LEP 2014. The house, gardens and trees are also listed as heritage items on the register of the National Trust of Australia (NSW).

### G3.1.2 Development to which this chapter applies

This chapter applies to development requiring consent under Woollahra LEP 2014.

### G3.1.3 Objectives

The objectives of this chapter are:

- 01 To define and conserve the cultural significance and curtilage of the property known as Hawthornden at 6-12 Roslyndale Avenue, Woollahra.
- 02 To encourage the preservation, restoration or reconstruction of its buildings/landscape elements (including vegetation) and setting which together contribute to its heritage significance.
- 03 To specify controls to ensure that any future development within its curtilage is subservient to the principal building and is undertaken in a manner that is sympathetic to and does not detract from its overall heritage significance and the heritage significance of the adjacent heritage item at 14 Roslyndale Avenue.

---

### G3.1.4 Relationship to other parts of the DCP

---

This chapter is to be read in conjunction with the other parts of the DCP that are relevant to the development proposal, including:

- ▶ Part B: Chapter B1 Residential Precincts (Woollahra)
- ▶ Part B: Chapter B3 General Development Controls
- ▶ Part E: General Controls for All Development - this part contains chapters on Parking and Access, Stormwater and Flood Risk Management, Tree Management, Contaminated Land, Waste Management, Sustainability, Signage and Adaptable Housing.

In the event of any inconsistency between this chapter and the other chapters, this chapter prevails unless otherwise specified.

---

### G3.1.5 Relationship to other plans and documents

---

#### Conservation Study

Applicants must refer to the Conservation Study of Hawthornden, prepared by Rod Howard Heritage Conservation Pty Ltd, August 1994.

---

### G3.1.6 Decision-making criteria

---

In making a decision on any development application with regard to Hawthornden, Council will take into account the extent to which it complies with the following criteria:

- a) the provisions of this DCP, Woollahra LEP 2014 and the Conservation Study;
- b) the objectives in Section 3.1.3 above;
- c) the statement of significance in Section G3.2 and illustrated in Figures 1, 2 and 3;
- d) the site curtilage as defined in Section G3.3 and illustrated in Figure 5;
- e) the conservation policy in Section G3.4;
- f) the detailed controls in Section G3.5; and
- g) the conservation outcomes in Section 3.1.7 below.

---

### G3.1.7 Conservation outcomes

---

The purpose of this chapter is to achieve the following conservation outcomes:

- a) The exterior form, fabric and architectural detail of the 19th century and significant early 20th century sections of Hawthornden will be conserved. Any proposed alterations will not diminish or destroy significant original fabric on any of the facades of the building.
- b) Significant spaces, fabric and detailing of the interior of the building which contribute to the overall significance of the place will be conserved. There will only be minimal and sympathetic alterations to heritage fabric or areas of most significance.
- c) Generally, all future alterations or additions to the buildings will read as new work. For example, details such as skirting, window and door frames and ceiling cornices will be similar and sympathetic, but not identical.
- d) The curtilage, setting and significant viewsheds from Hawthornden to the north and north-east will be preserved.
- e) The grounds, including especially the mature trees, distinctive functional spaces, driveway, and stone stairways and retaining walls will be conserved.



## G3.2 The cultural significance of the site

The first step in the conservation process is to identify and understand what is significant about the heritage item and/or place. This is in the form of a statement of significance, based on the terminology of the Burra Charter. Various items and elements of the site are then ranked in order of their heritage significance, as shown in Figures 1, 2 and 3.

### G3.2.1 Statement of significance

The cultural significance of the site is based on the following value criteria:

#### Historical

Hawthornden has historical significance as one of the oldest 19th century mansions (1858) in the suburban area of Sydney to survive with its regional setting and approach.

The whole of the site, one of the largest remnants in this locality, is evidence of the history of subdivision and social development in Woollahra in the 19th century, including subdivision into smaller leasehold estates.

#### Social

Hawthornden has social significance through its past use as a suburban estate and its successive occupancy by prominent figures of the day, including one who became Treasurer of the newly formed State of Queensland, another who later became Chief Justice and Lt. Governor of NSW, and several leading businessmen and directors.

Hawthornden provides evidence of affluent, upper-middle class life in the State since 1860, as demonstrated through the dignity of the house, its relationship to the garden, the spacious layout of the grounds, the nature of the various subservient buildings, and the range of its recreation facilities.

Hawthornden is held in high esteem by the local community, who value the presence of the large, landscaped and treed grounds in an area of Woollahra otherwise dominated by intensive subdivision and high densities of building.

#### Aesthetic

Hawthornden has aesthetic value deriving from the relative intactness of its Victorian Regency architecture, with colonial revival overlays, the spaciousness of its landscaped grounds, and its skilful perched siting and setting, in which the house is seen against trees, harbour and sky when viewed from the entrance gates, the driveway and from the Bellevue Hill Ridge.

Valuable, mature trees dating from the earliest period of development remain on this site, and have a rich visual presence in the surrounding locality. The composite palette of plantings that has accumulated over the last 140 years serves to enhance the setting, frame the house, and integrate it well into its site.

---

### Technical/Educational

In terms of its footprint, form, fabric and spatial arrangements, Hawthornden is largely intact and maintains some of its mid-Victorian structural qualities as well as many of its colonial revival details, ceilings, sashes, tile roof, etc. The house is a distinguished example of the remodelling work of the colonial revival architects, Wilson, Neave and Berry. It is unusual in their output in that it was a conversion of a plain Victorian Regency style house (subsequently refurbished in the filigreed 1880s 'boom' style) into a colonial [Georgian] revival house with a Mediterranean style verandah. Together with the contemporary neighbour Struan Lodge (14 Roslyndale Ave.) also by Wilson, Neave and Berry, built on the 1918 subdivision, it forms an interesting enclave of that firm's work.

The early specimen trees provide important evidence of late 19th century and early 20th century plantings and gardening practice in the Woollahra area. The successive planting overlays are each typical of their period, reflecting the prevailing style of landscaping at the time, the plants' availability in local nurseries, and the occupants' tastes and preferences.

### Representativeness

Hawthornden is a good representative example of a generous 19th century suburban state with a substantial stone mansion and landscaped grounds designed for and occupied since 1860 by affluent, upper-middle class residents of some eminence in NSW society.

It is also a good representative example of how such estates were successively subdivided as a consequence of increased pressure for land in this locality.

### Rarity

Hawthornden has rarity value in the Sydney metropolitan area as a private property, particularly with colonial revival style detailing, to have survived with its original building and an ample, core part of its setting largely intact.

It is also a rare example of the first houses erected on the edge of the ridge cliffs (hence Edgecliff Road) area of the Cooper Estate.

---

## G3.2.2 Rankings of significance

Heritage elements of various degrees of significance are listed below.

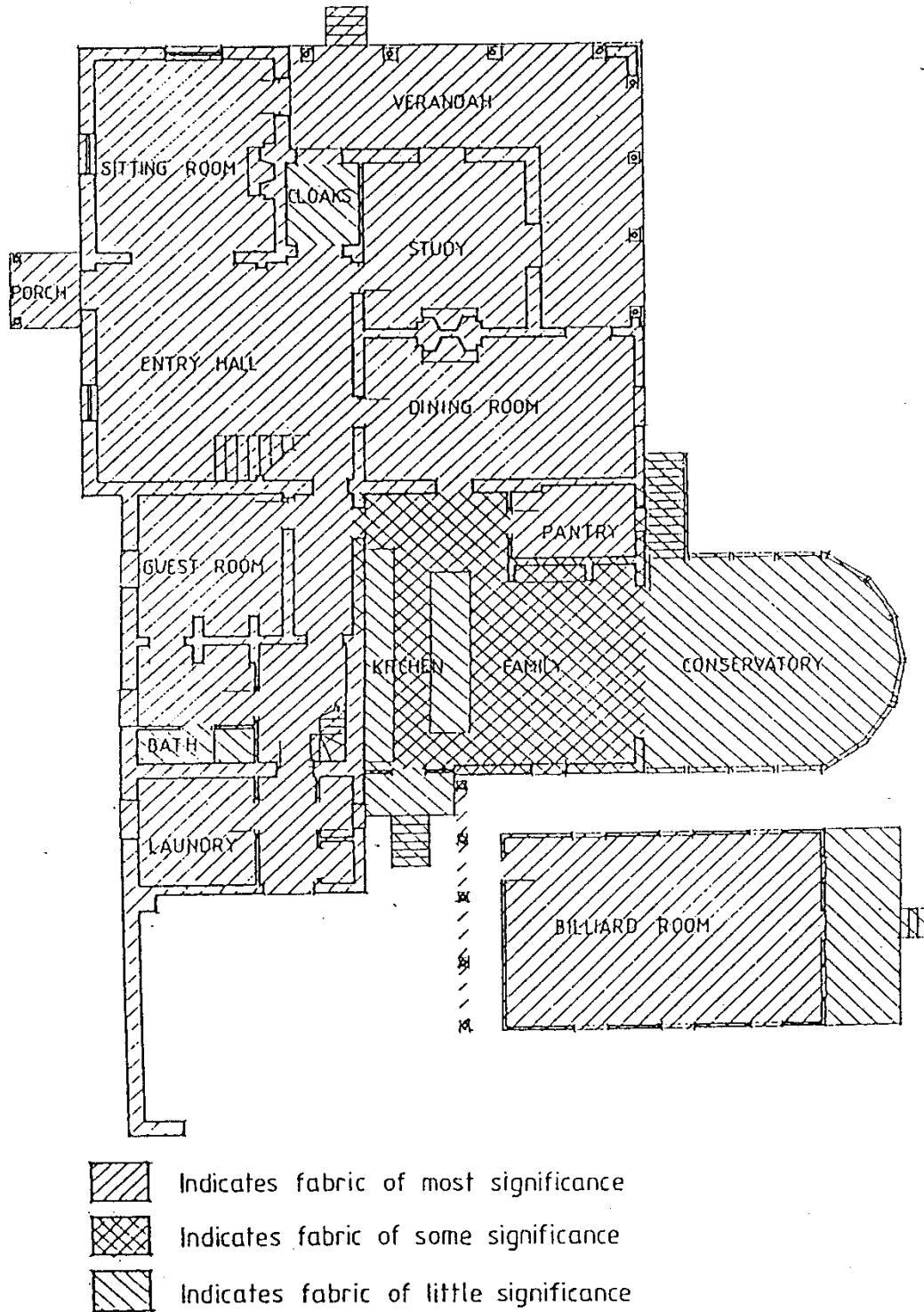
### Most significance

In general terms the elements of most significance are:

- ▶ the external form and plan configuration of the mansion (the house);
  - ▶ extant 19th century built fabric;
  - ▶ extant fabric from the 1927 modifications; and
  - ▶ the setting and landscaped grounds.
-

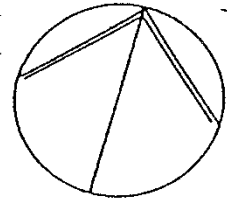
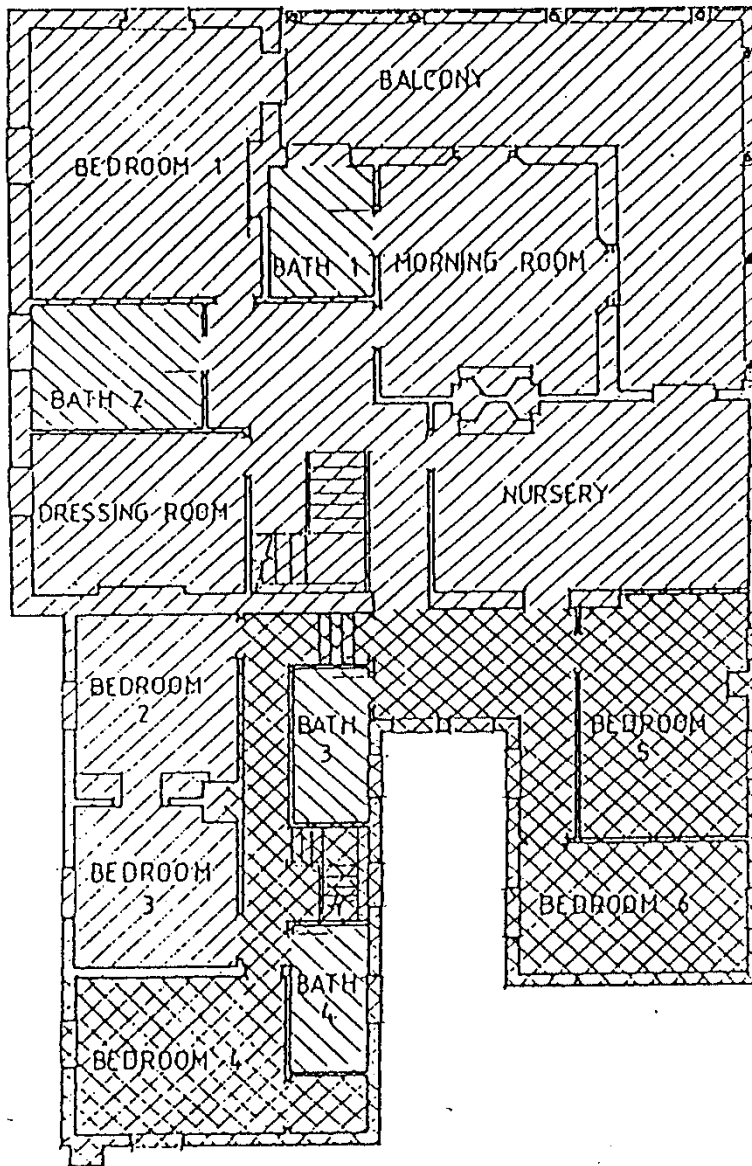
**FIGURE 1** Plan of ground floor indicating significant fabric




Source: Rod Howard Heritage Conservation Pty Ltd. 1994

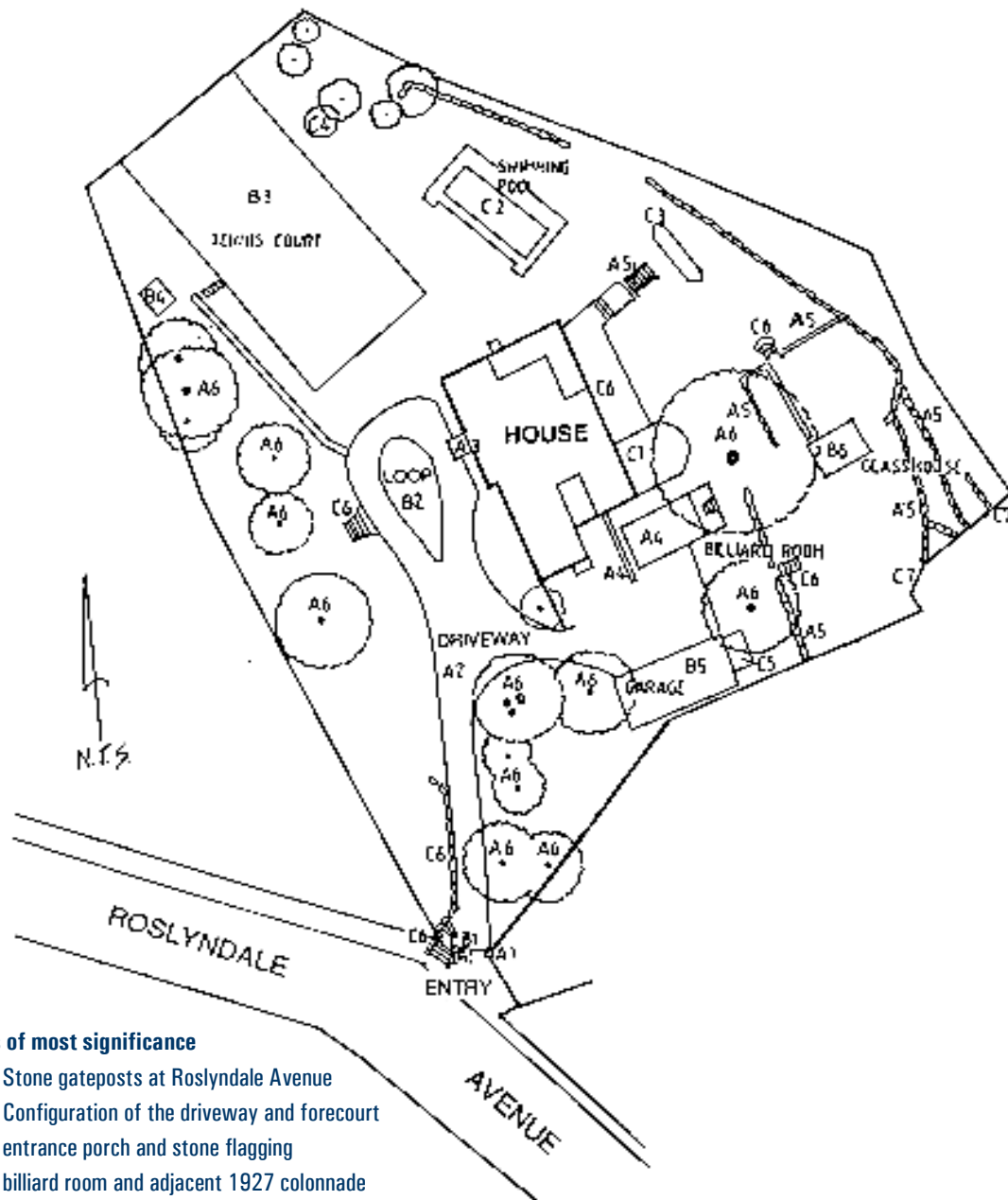


**FIGURE 2** Plan of first floor indicating significant fabric

Source: Rod Howard Heritage Conservation Pty Ltd. 1994



-  Indicates fabric of most significance
-  Indicates fabric of some significance
-  Indicates fabric of little significance

**FIGURE 3** Items of heritage significance**Items of most significance**

- A1 Stone gateposts at Roslyndale Avenue
- A2 Configuration of the driveway and forecourt
- A3 entrance porch and stone flagging
- A4 billiard room and adjacent 1927 colonnade
- A5 Original stone staircase and retaining in the garden
- A6 Bunya Pine and other 19th century and early 20th century trees
- A7 Viewshed to the north (see Figure 4)
- A8 Viewshed to the north-east (see Figure 4)

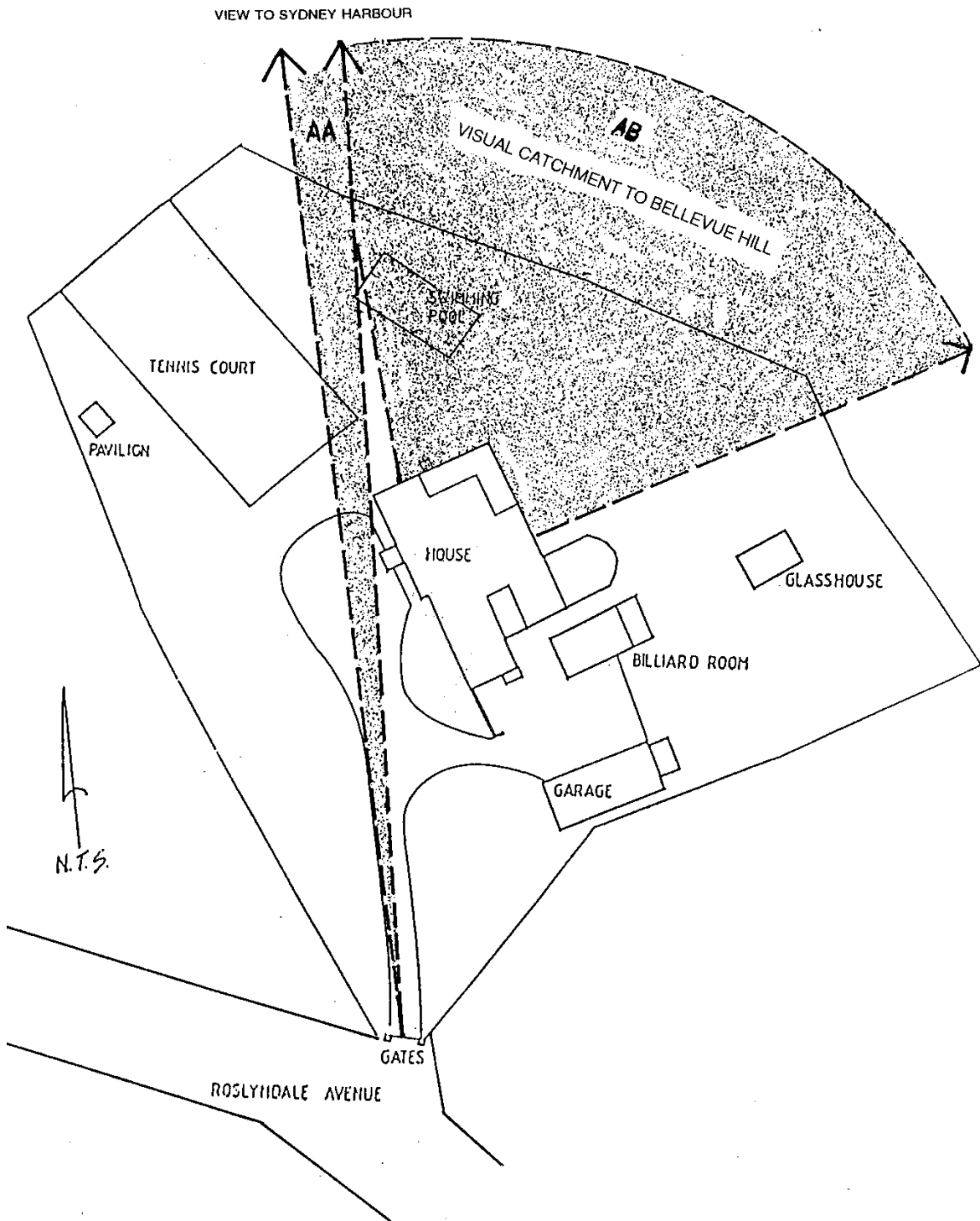
**Items of lesser significance**

- B1 Wrought iron entrance gates (not original)
- B2 Teardrop carriage loop
- B3 Tennis court
- B4 Timber tennis pavilion
- B5 Portion of the garage post-1927
- B6 Glass house (renewed several times)

**Later elements of little significance**

- C1 Glazed conservatory
  - C2 Swimming pool
  - C3 Lower pond
  - C4 Circa 1978 tennis pavilion (cabana)
  - C5 Later (eastern) addition to the garage
  - C6 Recent stone borders, steps and retaining walls in the garden areas
  - C7 Recent brick boundary wall near the south-eastern corner of the site
- Plus recent plantings and alterations to the garden

FIGURE 4 Viewsheds to the north and north-east



### G3.3 The curtilage for the site

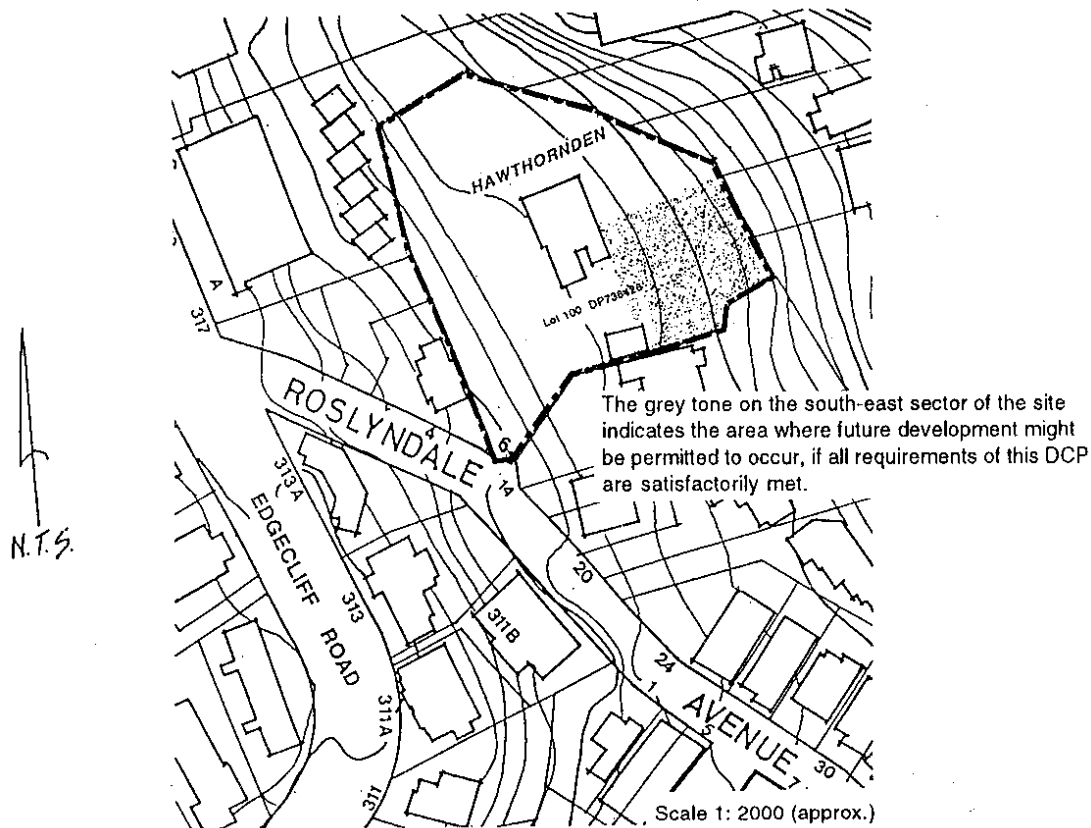
A curtilage may be defined as the area of land surrounding heritage items of places which is essential for their interpretation and the maintenance of their cultural significance.

It has been determined that the curtilage comprises the whole of the property as it currently exists, i.e. Lot 100, DP738428, and shown on the plan in Figure 5. The reasons for this determination are set out in Appendix 1 of this chapter.

However, should it become necessary for any development to be undertaken in order to generate funds to meet the cost of conserving the heritage fabric of the place, this may occur within the curtilage but only in the south-east sector of the site, and provided it is small in scale, subservient to the purposes of the main building, and no subdivision or strata titles on the land are involved. Such development must be undertaken in a manner that is sympathetic to and does not detract from the overall heritage significance of the dwelling house, the place as a whole and the adjacent heritage item at 14 Roslyndale Avenue.

**FIGURE 5** The curtilage for Hawthornden

The curtilage is indicated by the broken line on the below plan and encompasses the whole of Lot 100 DP 738428. This plan is indicative only, and the boundaries are subject to verification through survey.



## G3.4 Conservation policy for the site

The conservation policy for the site includes the physical constraints and those arising from the statement of significance and Burra Charter, which are set out in Appendix 2 of this chapter.

### G3.4.1 The conservation policy: general principles

- P1 Any conservation work undertaken on the house, significant site elements, or its setting should retain or recover the cultural significance of the place. The ‘significant elements’ are those noted in Section 3.2.2.
- P2 The perception of the house and setting as a consistent, holistic entity should be retained, as should all the component elements that contribute to its distinctive character as a Victorian ‘gentleman’s residence’.
- P3 No new construction, demolition or modification which would adversely affect the setting should be allowed and/or which would interrupt or obstruct:
  - a) the existing view of the house and beyond it to the Harbour gained by passers by looking down the entrance driveway from Roslyndale Avenue (see viewshed AA shown on Figure 4);
  - b) the existing view from the house itself north to the Harbour and east to Double Bay and Bellevue Hill (see viewshed AB on Figure 4); and
  - c) the successive views outward (as above) as one moves around the grounds.
- P4 Elements of significance occur in all portions of the site and should be retained and conserved in a manner appropriate to their degree of significance. Adaptation may be permitted where it does not substantially detract from the place’s cultural significance.
- P5 Fabric deemed to be of little significance may be removed or modified if it is intrusive, inappropriate, or harms significant fabric or stylistic elements. However, any such fabric should be recorded before removal.
- P6 An appropriate use should be found for the site which respects its original purpose, fabric and various spaces which facilitated its use and enjoyment.
- P7 All works on items deemed to be of high significance should be carried out under the direction and supervision of experienced conservation practitioners.
- P8 Any work carried out in the south eastern sector of the property must not have an adverse effect on the heritage significance of 14 Roslyndale Avenue.



---

### G3.4.2 The existing house

---

- P1 The exterior form and architectural detail of the 19th century and significant 20th century sections of the building as identified on Figures 1 and 2 should be conserved.
- P2 No alterations which could interfere with, or diminish, original (1858) or 1927 remodelled fabric on any of the facades of the building as identified on Figures 1 and 2.
- P3 The design of any new development within the property adjacent to the existing house should be similar to the architectural form, scale and character of that building and not detract from the cultural significance of the place.
- P4 Any construction activity occurring in the immediate vicinity of the building should be accompanied by all necessary precautionary action to prevent damage or other interference which could reduce its significance.
- P5 Significant interior spaces and principal features of the building which contribute to the overall significance of the place should be conserved. Only minimal and sympathetic alterations that are reversible and do not damage or remove significant fabric should be permitted in areas of most significance.
- P6 The billiard room should be retained and conserved. However, it has already been moved once in the past, and if - as part of any new development - it proves impractical to retain it in its present position, consideration could be given to relocating it, but only within the south-east sector of the site.

---

### G3.4.3 Other site elements

---

- P1 The sandstone gate piers at Roslyndale Avenue and the entrance driveway with tear drop loop in front of the house should be retained in their present location and configuration, and their sandstone elements conserved.
- P2 The historic open, sunny and spacious entrance forecourt should be retained.
- P3 The existing ground levels, and the various garden spaces and elements listed in the statement of significance as being of 'most significance' should be retained.

---

### G3.4.4 Implementation of the conservation policy

---

Every effort should be made to conserve the setting and historical fabric of most significance, and no intervention should be instigated without careful consideration of the alternative processes outlined in the Burra Charter to accomplish this end.

Fabric and site features deemed to have lesser significance should also be conserved wherever possible, with as little intervention as possible.

A program of maintenance should be established to ensure the continued good condition of all these elements.

Conservation works should be carried out in the following ways:

- ▶ conservation of remaining fabric of most significance in situ;
- ▶ removal of intrusive and, if necessary, non-significant fabric;
- ▶ reconstruction of elements of most significant fabric to be based on existing evidence and to match existing intact fabric as closely as possible; and
- ▶ preservation or restoration of the setting and landscape elements of most significance.

If retention of fabric of lesser significance adversely affects the proper conservation and adaptive reuse of fabric of most significance, it should be removed, but before doing so, it should be fully recorded and documented.

All demolition work of fabric of lesser significance that is deemed essential in any adaptive works to the house should be carried out in a manner which would not affect the fabric of most significance.

Any new works should be designed, located and executed in a manner which enhances and does not interfere with the significant elements of the house. New buildings or extensions should be designed in sympathy with the house.

## G3.5 Specific development controls

The controls below are based on the conservation policy in the previous section. The controls are to guide future development on the site.

### G3.5.1 Subdivision

Given that the curtilage consists of the whole site, a proposal for any further subdivision (including strata subdivision) of the property would be unacceptable to Council, being inconsistent with the objective of maintaining Hawthornden's integrity as a heritage item.

### G3.5.2 The dwelling

#### Exterior

- C1 The exterior form, fabric and architectural detail of the 19th century and significant early 20th century sections of the dwellings as identified in Figures 1 and 2 are to be conserved. Proposed alterations must not diminish or destroy significant original fabric on any of the facades of the building.
- C2 Any proposed new structures should be consistent with the plain, rectangular form of the dwelling.
- C3 The walls of any ground floor extensions to the dwelling should be of ashlar sandstone blocks of similar proportions, surface treatment and mortar jointing as in the original walls. However, the walls of the first floor should be of brick, cement rendered, ruled out with joints to indicate the original sandstone coursing, and painted to match the rest of the building.
- C4 The proportions of the openings and their timber frames in any new structures or extensions should be similar, but not identical, to those of the dwelling.
- C5 Any supporting columns, e.g. in a new verandah, should be of the same Tuscan style, capitals, relative proportions and material as those of the 1927 remodelling.
- C6 All windows should be of the wooden, double-hung sash type, with four or six panes similar to those on the northern section of the house.
- C7 Any new roof should match the hipped form of the house. Its tiling should match the existing Wunderlich French pattern tiles installed in 1927.
- C8 New chimneys should be constructed to similar form, height, materials and detailing to the original chimneys at the northern end of the house.

---

## Interior

- C1 Significant interior spaces, fabric and detailing of the building identified in Figures 1 and 2 which contribute to the overall significance of the place are to be conserved. Only minimal and sympathetic alterations will be permitted to heritage fabric or areas of most significance.
- C2 The internal joinery of the windows, particularly those in the northern section of the house should be carefully conserved. Joinery for windows in future alterations or extensions to the eastern or southern sections of the house should generally be similar to, but need not be identical with, those in the northern section.
- C3 It is desirable, wherever possible, to conserve the original ceilings and cornices or those fitted during the 1927 remodelling of the house. If conservation work uncovers earlier ceilings above the latter which could be restored or preconstructed, expert advice sought as to whether they should have precedence over the 1927 fabric. Ceilings fitted after 1927 are not regarded as having heritage significance, and could be replaced by ones that resemble either the original ceilings or those of the 1927 refitting.
- C4 Skirting boards should be of timber and generally follow the form and dimensions of those in the north-eastern rooms of the house.
- C5 Light fittings should generally be sympathetic to the historic character of the house.
- C6 Fireplaces, grates, mantelpieces and their surrounds should generally be in the style and materials of those typical of the mid to late Victorian period, or of the early 20th century, and not be fitted uncharacteristically forward of the fireplace opening.
- C7 Because Victorians used both a wide range of paint colours and wall papers in interior decoration, and schemes used in the colonial revival style are generally more muted and plainer, it is not possible to specify any particular scheme in this DCP. In any case, interior decoration is an area in which some allowance should be made for personal taste and self-expression. However, it is recommended that the advice of a period interior designer or house historian be sought when interior redecoration is being considered.

### G3.5.3 Heights

---

- C1 The wall height of any proposed extension or addition must not exceed the height of the walls of the existing dwelling.
- C2 The roof height, pitch and form of any proposed extension or addition should preferably be up to 500mm lower than that of the main building.
- C3 The height of any new self-standing, subsidiary structures on the site should not exceed that of the existing billiard room and garage. An increase could be permitted to the extent (i.e. by the number of metres of vertical fall) that the proposed new structure would be downslope of those present structures. Any increase allowed must consider the effect of the height on the amenity and heritage significance of the adjacent property at 14 Roslyndale Avenue.

---

### G3.5.4 External materials, colours and finishes

---

- C1 Generally, the materials, finishes and colours of new structures on the site should be sympathetic to those of the existing 1927 colonial revival architectural style.
- C2 The colours of any new works should match those of the exterior walls of the existing building. The present colour (ivory/cream) is generally regarded as appropriate; however, alternatives could be approved if investigations reveal that these were original (1858) or used in the 1927 redecoration.
- C3 The colour of elements such as shutters, verandah railings, and the external woodwork of windows and doors should be of an appropriate contrasting hue. The present dark green is appropriate, but alternatives could be approved if investigations reveal that these were original (1858) or used in the 1927 redecoration.
- C4 The driveway, including the tear drop loop of the entrance forecourt should continue to be of bitumen, with sandstone kerbing.

---

### G3.5.5 Garden elements, landscaping and management of significant vegetation

---

- C1 The existing levels and features of the various garden spaces such as sandstone stairways, retaining walls, paths and edging should be retained.
- C2 The sandstone gate piers at Roslyndale Avenue and the entrance driveway and carriage loop at the front of the house should be conserved.
- C3 The entrance forecourt should be retained. The interior of the tear-drop loop should be paved with gravel and its slope and levels should be adjusted just sufficiently to collect and drain water away from the front of the house. A Bangalay Palm could be planted within the northern section of the loop, as in the 1920s.
- C4 Trees dating from the 19th and early 20th century should be protected and conserved. Any remedial work should be undertaken by a qualified and experienced arborist.  
  
Note: Council consent is required for any tree works affecting trees or other vegetation that are prescribed under the Woollahra DCP.
- C5 Where mature trees have become senescent or have been poisoned, consideration should be given to their replacement, if possible in advance of their final demise and removal. Given the desire of owners of more recently built neighbouring dwellings on the western perimeter also to have access to sun and views across the grounds of Hawthornden to the north-east, consideration could be given to replacing them by plants with a similar character and design intent, but of more modest height and canopy spread. However, 'signature' or landmark plantings such as the Bunya Pine should only be replaced by the same species.

- 
- C6 Some plants popular in the late 19th and early 20th century such as Camphor Laurel, Wild Olive, Giant Bamboo and Privet, have since been declared noxious because of their rapid reproductive capacities. Should they die, they should not be replaced by the same species. An effort should be made to select plants with a similar character and design intent, but with a more modest height and canopy spread and no propensity to multiply.
  - C7 Not all plantings made since 1927 have been well located, and as they are of little heritage value, Council is prepared to consider applications for their removal or relocation to a more appropriate position. This applies particularly to the two Liquidambar planted at the northern end of the entry forecourt, as they obstruct the view to the harbour from the entrance drive and have no heritage significance.
  - C8 The steeply sloping banks, turfed in buffalo grass, of the terraced eastern garden are characteristic of the late 19th and early 20th century, and should be retained and carefully maintained.
  - C9 The various garden ‘rooms’ and divisions in the south-east sector have no particular heritage value, although some of the mature plantings on the periphery do. Council would be prepared to consider applications for the redesign of this area by a qualified conservation landscape architect.
  - C10 Access to the excellent views outwards to the east could be improved by the judicious location of selected breaks in the screening planting. Council would be prepared to consider applications for this purpose, subject to the preparation of a landscape planting plan proposing an appropriate scheme prepared by a conservation landscape architect.
  - C11 Although the tennis court and the swimming pool are listed as being of lesser and no heritage significance respectively, the provision and location of these facilities is suitable and appropriate for this type of property. It is desirable, though not mandatory, that they be conserved.

Note: Council consent is required for any tree works affecting trees or vegetation that are prescribed under Woollahra LEP 2014.

### **G3.5.6 Protection of viewsheds**

---

- C1 No construction of buildings or planting of trees should take place which would obstruct the viewsheds defined in Figure 4.
- C2 Some consideration should be given to the desire of neighbours on the western side of Hawthornden’s boundary for access to view to the north-east. Judicious pruning of exuberant tree canopies by a skilled arborist could assist in facilitating that aim.

---

### G3.5.7 Future development in the grounds

---

#### General

No new structures shall be permitted other than in the south-east sector of the site (see Figure 5), where views outwards are blocked by thick plantings (some of heritage value), both within and beyond the property. Consideration must be given to the impact of any new structure on the heritage significance of the property at 14 Roslyndale Avenue.

- C1 Only structures which satisfy the service or recreational needs of the occupants of the dwelling would be considered in that quarter.
- C2 The design of any new development within the south-east sector or adjacent to the existing house should be sympathetic to the architectural form, scale and character of that building, and be of such a limited mass as in no way to compete with it.
- C3 Any construction activity occurring in the immediate vicinity of heritage buildings should be accompanied by all necessary precautionary action to prevent damage or other interference which could reduce their significance.
- C4 In order to avoid damage to the roots of trees of heritage significance (e.g. the 19th century Camphor Laurels) the use of pier and beam construction rather than traditional foundations may need to be considered.
- C5 The billiard room should be retained and conserved. However, as this has already been moved one before, consideration may be given to adjusting the location of this element, but only within the south-east sector of the site.
- C6 Should demolition of the glass house, post-1927 alterations to the garage, or a section of the garden's sandstone retaining walls be proposed to allow new subservient structures to be erected to improve the amenity of the dwelling, Council is prepared to consider this. Although each of these elements has some significance, the loss of one, or possibly two, of them would not adversely affect the interpretation of the site. However, they must be recorded before any approved demolition occurs. If they are to be retained, they should be treated in such a manner that their significance is not diminished.

#### Setback requirements

The subdivision of this site occurred in 1918 and the existing setback of the 1927 garage and man's quarters do not comply with Council's general setback standards in this DCP.

Given that situation and the width and configuration of the Hawthornden site, it may be inappropriate for the general side setback controls to be applied to future development on that site. Generally, however, any new subservient structure in the south-east section of the site should be set back no less than 7m from the eastern boundary, and 3m from the southern boundary.

### **G3.5.8 Pedestrian and vehicular access and parking**

---

- C1 It would better suit the heritage value of Hawthornden to maintain the present arrangements for pedestrian and vehicular access.
- C2 If future owners were to consider that provision for visitor parking should be upgraded, Council is prepared to consider a proposal, provided it does not adversely affect the heritage fabric or cultural significance of the place.

### **G3.5.9 Conservation incentives relating to heritage items**

---

Refer to clause 5.10(10) of Woollahra LEP 2014.



---

## G3.6 Requirements for development applications affecting the site

### G3.6.1 Preparatory steps

---

Persons preparing a development proposal should make a prior study of:

- ▶ Council's heritage report information requirements;
- ▶ the statement of significance as set out in Section 3.2.1 of this chapter;
- ▶ the curtilage as set out in Section G3.3 of this chapter; and
- ▶ the specific controls as set out in Section G3.5 of this chapter

before proceeding to the drafting of any plans or development application.

### G3.6.2 Minor development

---

Minor development such as:

- ▶ routine maintenance;
- ▶ interior redecoration of rooms remodeled after 1930;
- ▶ planting or replanting schemes for small shrubs, perennials and annuals; and
- ▶ relocation of minor garden elements

does not require a development application to be submitted.

However, applicants should check with Council officers whether any other Council codes or development control plans are applicable to the development proposed.

## Appendix 1 – Curtilage of the site

### Background

---

The leasehold land on which Hawthornden was built comprised approximately 10 acres in July 1857. The estate was substantially subdivided in 1918, leaving Hawthornden with an area of land comprising 1 acre, 2 roods and 21.5 perches. In 1985 and 1986 two minor subdivisions were made, involving small adjustments to the southern boundary. The site is known as Lot 100 in DP 738428 and comprises 6,517m<sup>2</sup>.

### History of development

---

The basic layout of the site appears to have been established quite early, with major plantings such as the Camphor Laurels and the Bunya Pine. The entrance gates and driveway were well established by 1884, and the whole of the land to the north of the mansion was shown as 'shrubbery and flower garden'. The garden to the east was also a terraced flower garden. The land immediately to the east of the entrance drive gate (but south of the house) was shown as 'cultivation'.

Despite the remodelling of the house in 1927, the general setting of the garden and grounds was retained within a still very large block, and the extensive gardens continued to be maintained to a high standard.

After a period of general neglect during 1973-76, the house was restored/refurbished between 1978 and 1993, as well as the gardens and grounds. Again, this was done within the general framework of the historic layout and planting, with some older materials such as sandstone being reused, especially in the south-eastern section.

In sum, much of the early extent, layout and planting of the historic garden setting to the house survives, namely:

- a) The important original siting of the house and its proximity to the sandstone cliff below to the north-east. This setback was a deliberate siting response to the topography and view possibilities.
- b) The house is still surrounded by a large extent of grounds on all its principal frontages (except the south). This is extremely rare in built-up areas of Sydney, especially for houses still in private ownership.
- c) The property still retains its original entrance gate pillars and carriage drive; it is not clear if the tear-drop shaped centre existed before 1927.
- d) The historic view to the harbour from the entrance driveway, and from the north and north-eastern frontages of the house remains, but is best seen from the upstairs verandahs.

- e) Many of the historic mid to late 19th century and early 20th century plantings remain. Most are in good health. The National Trust listing, revised in 1994, concluded that “the 19th century trees are important elements of 19th century gardening practice, as well as being important local landmarks. It is probably the last substantial garden situated on the Woollahra hillside.”

The Record of Hearing of the Land and Environment Court (Appeal no. 10487 of 1995) described the siting and layout of the house and grounds, noting the extensively landscaped gardens and the views of Sydney Harbour from the mansion’s two storey verandah. It added that:

“The harbour is also visible from the driveway near the gates looking towards the north. From this viewpoint the main section of Hawthornden is framed by an arcade of trees in the foreground, the landscaped gardens in the middle distance, the waters of the Sydney Harbour and the sky [in the background]. This view has changed little since the building was erected...”

Mr Lehany, in evidence, stated that, the house is picturesquely sited above a major sandstone escarpment and oriented towards dramatic harbour views from the north to the north-east. The Court assessment referred to the “perched nature of the grounds and the relationship to the harbour” from viewing points in the driveway. It agreed with Mr Lucas’ emphasis on the importance of the setting and approach, and said that the 1994 Conservation Study had given too little consideration to it.

## Methodology for determining a curtilage

---

Based on the draft guidelines for determining curtilages for heritage places prepared for the Department of Urban Affairs and Planning in 1994, the following factors have been taken into account:

- ▶ Can the curtilage demonstrate the place’s historic allotment - the original land grant, leasehold, or at least the core portion of it?
- ▶ Is there evidence of original allotment boundaries that can be maintained?
- ▶ Can the curtilage demonstrate how the environmental context and setting of the place assist in understanding and interpreting it?
- ▶ What are the significant natural and human-made features of the place that must be preserved?
- ▶ How do the design and layout of the place (including its present boundaries) contribute to its significance?
- ▶ Does the proposed curtilage demonstrate and/or maintain the place’s traditional access and transportation links with the broader community?
- ▶ Does the combination of items, together with their surrounds, contribute in a cumulative way to the meaning and significance of the place?
- ▶ Do the functional uses of items and spaces and the relationships between them contribute to the understanding and interpretation of the site?
- ▶ Does the curtilage need to maintain scenic viewsheds, as well as visual links with key places - main roads, towns, rivers, harbours and hills?

- 
- ▶ Will the proposed curtilage maintain the proportion or scale of an item within its site/setting?
  - ▶ Does the curtilage take account of the vegetation and its historic, aesthetic, functional and/or technical roles?
  - ▶ Does the proposed curtilage maintain the place's landmark qualities?
  - ▶ Does the proposed curtilage protect any possible archeological features?
  - ▶ Should the curtilage include or recommend framing and screening devices?

Taking each factor into consideration, the following conclusions have been reached:

### 1. The original allotment

As mentioned above, the leasehold land on which Hawthornden was built comprised approximately 10 acres in July 1857, being part of a large tract of land originally granted to Captain John Piper, and subsequently acquired by Daniel Cooper in 1826. When the 1918 subdivision occurred, adequate space was left to the north, from where there were views to the harbour. Only one new block was created between the neighbouring property (on which there was already one house in 1884) and the northern garden of Hawthornden.

The fact that this side was not more subdivided indicates that those owning the house understood that the northern sector, and the views through it to the Harbour, was the most important part of the grounds. That consideration was shared by the assessor in the recent case before the Land and Environment Court.

Although the construction of the tennis court resulted in the destruction of the shrubbery garden in the northern section of the block, it did at least ensure that by being 'transparent' open space, the view through to the Harbour from the entrance drive was retained, even though this has been partly obscured in summer by unfortunately placed plantings in more recent times.

### 2. Maintaining original boundaries

Although the 1918 subdivision reduced the estate to about one tenth of its original size, there was no reduction on the eastern side, where the steep rock benches are. This boundary is intact, and should remain so. Only a fragment of the original southern boundary is intact, and none of the western boundary is. However, these have remained virtually unaltered (apart from minor adjustments) since 1918.

### 3. Environmental context and setting

The 1994 Conservation Plan states that it is necessary to preserve the historic situation of the mansion as a free-standing 19th century building in a large estate, so characteristic of early settlement in Woollahra; and to preserve a sufficient portion of the site so that this relationship can be successfully interpreted. It is considered that the whole of the site is essential for this purpose.

### 4. Significant natural and human-made features

The significant natural features of the site comprise the sandstone rock benches, principally on the east and north-east which - because they fall sharply away - permit extensive views out in those directions. They also define that boundary edge of the site, and have protected it from further subdivision in that quarter.

---

---

The most significant human-made features of the site comprise the house itself, the entrance porch and stone flagging, the billiard room and adjacent 1927 colonnade, the stone staircase to the eastern terraced garden, the stone gateposts at Roslyndale Avenue, and the configuration of the driveway. Lesser items of significance are the wrought iron entrance gates, the ‘tear-drop’ turning area adjacent to the house, the glass house, the portion of the garage dating from 1927, and the tennis court and timber tennis pavilion. These should all be included within the curtilage.

#### **5. Design and layout**

The placement of the mansion towards the north-eastern edge of the original site ensured best access to the views out to the Harbour and to cooling breezes from that direction in summer. However, it was sufficiently set back to permit a terraced garden on the east, a generous shrubbery on the north, and a vegetable garden and orchard in the south-eastern sector. The gently sloping space to the west of the site permitted the development of a spacious forecourt which enabled the house to be best presented from that quarter and accessed via a driveway to the front porch (with the garage nearby). Many of these different functional spaces are linked by sandstone steps and paths, while bold planting, both on the perimeter and between the different areas, gives them a good sense of spatial definition and enclosure.

#### **6. Access and transportation links**

The place’s access to Roslyndale Avenue was established at the time the house was built (c. 1858), and the entrance gateway presumably soon afterwards. This arrangement has remained unaltered since, primarily because access from the north and east was prevented by the sandstone rock benches and/or steep slopes. For historical, aesthetic and functional reasons, these arrangements should be maintained.

#### **7 and 8. Combinations and interrelationships**

It is the combination of, and interrelationships between, these various elements - the portentous entrance gates, the carriage drive and loop, the classically styled building, the billiard room, the tennis court, the swimming pool - that demonstrated the uses, activities and lifestyles of the successive upper-middle class occupants; in other words, that give the whole place its cultural meaning. By themselves, some of these items are of little if any inherent significance (as the list demonstrates): it is the role that, cumulatively, they play in contributing to the overall use, understanding and interpretation of the place that gives them significance.

#### **9. Viewsheds and visual linkages**

The view from the entrance gate through the frame of the planting on the property out to the Harbour is highly valued by the passing public, visitors, and residents. It is essential that the view be retained, both from the entrance driveway and from the rooms and verandahs of the house. Views out to the ridge and valley on the east, and of the property from the Bellevue Hill ridge, are also important to retain.

#### **10. Proportion and scale**

It is generally considered that the spacious grounds which surround the house are well proportioned in relation to the large scale of the house, and that it would be most undesirable to reduce them further in size.

---

## 11. Vegetation and its role

Numerous mature trees frame and screen the site, particularly on the south and west. One - the Bunya pine - is listed on Council's register of significant trees. A few trees are mid to late 19th century plantings, and demonstrate the landscaping style and taste in plants prevalent in Woollahra at that time. They also provide an indication of the attitudes and lifestyles of the occupants of the site, and contribute both aesthetic value and amenity. As LandArc's Landscape Heritage Assessment Report (1994) stated: "The sum total of all these trees adds enormously to the visual quality and asset value of the property". According to the Woollahra History and Heritage Society, "it is the largest remaining cluster of garden and trees on the Edgecliff escarpment". They should therefore be conserved.

Note: Council consent is required for any tree works affecting trees or other vegetation that are prescribed under the Woollahra DCP.

## 12. Landmark qualities

It is the same mature vegetation (particularly the Bunya Pine), rather than the house (which is partly obscured by the dense planting) which gives the place a rich green, landmark quality when viewed from the east. This characteristic, identifying feature should be preserved.

## 13. Archeological features

Neither the Conservation Study of 1994 nor subsequent reports have identified, or suggested that there might be, archaeological features that need to be protected via a curtilage on this site.

## 14. Framing, screening and buffer zones

The mature trees on the western and southern boundaries of the site provide a good measure of screening, while the line of Bangalay Palms on the northern boundary ameliorate the impact of the high apartment block beyond. It is desirable that this screening be conserved. However, elements such as the wisteria vine on the tennis court fencing, and the wild olives and bamboos along the eastern boundary, need to be firmly contained, as they interfere with the viewsheds.

## Conclusion

---

There is no one portion of the site of distinctly less significance that it should not be conserved; the curtilage should therefore consist of the whole of the property as it currently exists. This corresponds with the views expressed by the Land and Environment Court in 1995.

Should it become necessary for any development to be undertaken in order to generate funds to meet the cost of conserving the heritage fabric of the place, this could occur within the curtilage but only in the south-east sector of the site, and provided it is small in scale, subservient to the purposes of the main building and no subdivision or strata titles on the land are involved. Such development must be undertaken in a manner that is sympathetic to and does not detract from the overall heritage significance of the dwelling house and the place as a whole.

## Appendix 2 – Conservation policy: constraints

### Constraints arising from the statement of significance

Generally, changes to the use of spaces and portions of the site may only take place if they do not affect the interpretation of the significance of the place. Thus no activity should occur which would:

- ▶ significantly detract from or interfere with the relationship between the house and its setting;
- ▶ remove or reduce the evidence of historical associations and social activity contained within the significant fabric of the house and component elements of the site; and
- ▶ reduce the intactness of the site's remaining significant fabric and setting.

Any future action should take the following into account:

- ▶ Original and significant fabric on the site should be retained and conserved. This includes the house, the billiard room, the garage, and mature trees.
- ▶ The site has throughout its history been used as a residence, for which purpose the building and its ancillary structures have been designed.
- ▶ Evidence of past use contained in the built fabric and in spaces such as the entrance forecourt, the presentation garden, the eastern terraced garden, and the fruit and vegetable garden, should be conserved wherever possible.
- ▶ No activity should occur which prejudices the character of the place.

### Constraints arising from the Burra Charter

The Burra Charter provides guidelines for conservation work and practices. The following are constraints arising from the application to Hawthornden of relevant articles of the Charter:

- ▶ Conservation work should retain or recover the cultural significance of a place, and must include provision for its security, its maintenance and its future. [Article 2]
- ▶ All conservation is based on a respect for the existing fabric and should involve minimum intervention. It should not distort the evidence provided by the fabric. [Article 3]
- ▶ The conservation policy appropriate to a place must first be determined by an understanding of its cultural significance and its physical condition. [Article 6]
- ▶ The conservation policy will determine which uses are compatible. [Article 7]
- ▶ Conservation requires the maintenance of an appropriate visual setting, e.g. form, scale, colour, texture and materials. No new construction, demolition or modification which would adversely affect the setting should be allowed.
- ▶ Adaptation is acceptable where the conservation of the place cannot otherwise be achieved, and where the adaptation does not substantially detract from its cultural significance. [Article 20]. However, this must be limited to that which is essential to a use for the place determined in accordance with Articles 6 and 7.

- 
- ▶ The contributions of all periods to the place must be respected. If a place includes the fabric of different periods, revealing the fabric of one period at the expense of another can only be justified when what is proposed to be removed is of slight cultural significance. [Article 16]
  - ▶ Any work on a place must be preceded by professionally prepared studies of the physical, documentary and other evidence, and the existing fabric recorded before any disturbance of the place. [Article 23]
  - ▶ Disturbance of fabric may occur in order to provide evidence needed for the making of decisions on the conservation of the place. [Article 24]
  - ▶ Appropriate professional direction and supervision must be maintained at all stages of the work. [Article 27]

### Constraints arising from the physical circumstances of the site

---

The steep cliffs and rock benches on the eastern and north-eastern edge of the site have provided a natural boundary to the property throughout its history, and effectively prevent access to it from those directions. Intensive subdivision and construction of housing almost on the southern, western, and north-western boundaries also prevent access to the site from those quarters, and provide a strong sense of enclosure.

The virtual wall of multi-residential development along those boundaries indicates that the limits of development have been achieved in those sectors, except perhaps in that adjacent to the far northern boundary of Hawthornden, and that the surroundings and context of the property are now fixed. It also means that the grounds of Hawthornden are extensively overlooked and lack visual and aural privacy except in its lower, eastern sector.

Although not wholly a heritage issue, a further constraint is the poisoning of tall, dense, late 19th century heritage plantings along the property's western boundary. This is mute testimony to the desire of residents in most adjacent dwellings to have clear visual access across the grounds of Hawthornden to obtain good views to the north-east and east. There is therefore a need to achieve a just balance between Hawthornden's occupants' desire to retain heritage and other plantings which provide screening for privacy, and their neighbours' desire for access to good views.

Finally, the large extent of the grounds and their steady fall towards the east means that any further development on the site involving the creation of additional, impermeable surfaces will necessitate the installation of storm water detention basins to control the flow of runoff onto neighbouring properties below to the east. Unless skilfully designed, this could cause serious disruption to heritage elements.



# Chapter G4

## 9A Cooper Park Road, Bellevue Hill

Part G ▶ Site-Specific Controls

CHAPTER G4 APPROVED ON 27 APRIL 2015  
AND COMMENCED ON 23 MAY 2015

Last amended on 12 April 2021



# Chapter G4 ▶

## 9A Cooper Park Road, Bellevue Hill

### Contents

<b>G4.1</b>	<b>INTRODUCTION .....</b>	<b>1</b>
	G4.1.1 Land where this chapter applies.....	1
	G4.1.2 Development to which this chapter applies.....	1
	G4.1.3 Objectives.....	2
	G4.1.4 Relationship to other parts of the DCP .....	2
	G4.1.5 Relationship to other documents .....	2
<b>G4.2</b>	<b>DESIGN AND SITING OF DEVELOPMENT .....</b>	<b>3</b>
	G4.2.1 Objectives and controls.....	3



## G4.1 Introduction

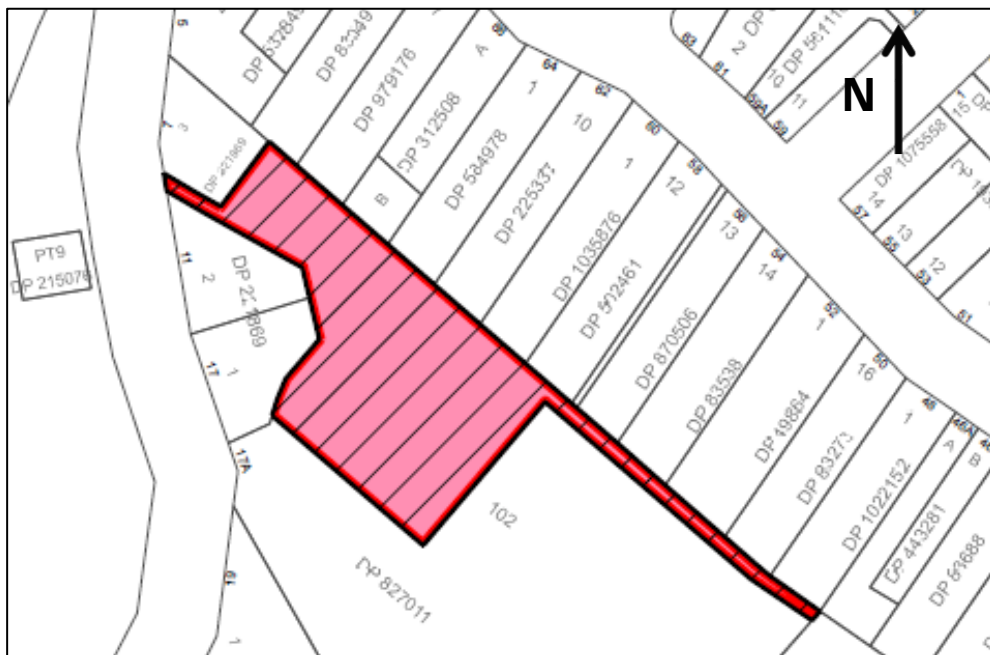
Land at 9A Cooper Park Road, Bellevue Hill, is zoned to 2(b) Medium Density Residential under Woollahra Local Environmental Plan 2014 (Woollahra LEP 2014). Woollahra LEP 2014 also sets a maximum building height of 9.5m and a floor space ratio of 0.63:1 for the land.

It is envisaged that the land will be redeveloped for a residential purpose. The LEP controls will permit medium density residential development. The controls in this chapter seek to guide development on the land.

Note: This chapter reflects the site specific development control plan adopted by Council on 16 December 2013, and which commenced on 8 January 2014.

### G4.1.1 Land where this chapter applies

This chapter applies to land known as 9A Cooper Park Road, Bellevue Hill, being Lot 101 DP 827011, as identified on the plan below.



### G4.1.2 Development to which this chapter applies

This chapter applies to development requiring consent under Woollahra LEP 2014.

---

### G4.1.3 Objectives

---

The objectives of this chapter are:

- O1 To facilitate development that is permissible under the provisions of Woollahra LEP 2014.
- O2 To guide the design and location of development to address the amenity of adjoining properties.

---

### G4.1.4 Relationship to other parts of the DCP

---

This chapter is to be read in conjunction with the other parts of the DCP that are relevant to the development proposal, including:

- ▶ Part B: Chapter B1 Residential Precincts (Bellevue Hill South)
- ▶ Part B: Chapter B3 General Development Controls
- ▶ Part E: General Controls for All Development - this part contains chapters on Parking and Access, Stormwater and Flood Risk Management, Tree Management, Contaminated Land, Waste Management, Sustainability, Signage and Adaptable Housing.

In the event of any inconsistency between this chapter and the other chapters, this chapter prevails unless otherwise specified.

---

### G4.1.5 Relationship to other documents

---

#### State Environmental Planning Policy No. 65 - Design Quality of Residential Flat Development

The New South Wales Government's State Environmental Planning Policy No. 65 - Design Quality of Residential Flat Development (SEPP 65) is a mandatory consideration for development applications involving a residential flat building that is 3 or more storeys and contains 4 or more self-contained dwellings.

SEPP 65 contains principles for good design and provides guidance for evaluating the merit of design solutions, and is supported by the Residential Flat Design Code 2002. The Code contains detailed information about how development proposals can achieve the design quality principles in the SEPP, addressing matters such as building separation and building configuration.

Where SEPP 65 applies, the development application must be accompanied by a design verification from a qualified designer, confirming that:

- ▶ he or she designed, or directed the design, of the development; and
- ▶ the design quality principles set out in SEPP 65 are achieved for the development.

## G4.2 Design and siting of development

### G4.2.1 Objectives and controls

Objectives	Controls
<p>O1 To ensure that the siting of development does not unreasonably impact on the amenity of adjoining properties.</p>	<p>C1 No numeric setback is specified. A setback is provided at all boundaries which adjoin the property that:</p> <ul style="list-style-type: none"> <li>is sufficient for development to minimise privacy and overshadowing impacts;</li> <li>can deliver best practice building separation controls contained in the Residential Flat Design Code 2002;</li> <li>is an effective dimension to enable opportunities for private open space in conjunction with landscaping; and</li> <li>can accommodate substantial and effective landscape planting and screening along boundaries.</li> </ul> <p>Note:</p> <ul style="list-style-type: none"> <li>► The setback controls in Chapter B3 of the DCP, General Development Controls (B3.9 Additional controls for development on a battle-axe lot) do not apply to this site.</li> <li>► The Residential Flat Design Code 2002 was produced by the NSW Planning Department as a resource to improve the design of residential flat development.</li> </ul> <p>C2 Where suitable, deep soil landscaping or screen landscaping is provided within the boundary setback areas to reduce overlooking.</p>

Objectives	Controls
<p>O2 To ensure that development is designed to reflect view sharing principles.</p>	<p>C3 Having regard to views over the site from adjoining properties in Bellevue Road, the building design demonstrates that view sharing has been addressed. This should be through thoughtful distribution of built form across the site and well-considered building design and landscaping, addressing matters such as, but not limited to:</p> <ul style="list-style-type: none"> <li>a) reduced development intensity, such as a single storey building height, on parts of the north-eastern end of the site;</li> </ul> <p>increased setbacks along the boundary adjoining No.60 Bellevue Road;</p> <p>building modulation including separation of buildings or their components;</p> <p>articulated roof forms;</p> <p>suitable location of vegetation, particularly in regard to the height and width of species;</p> <p>location of aerials and telecommunication devices;</p> <p>location of photovoltaic panels; and</p> <p>any other architectural and design solutions.</p> <p>Note: A view analysis must be submitted with a development application addressing matters identified in <i>Tenacity Consulting v Warringah Council [2004] NSWLEC 140</i>.</p>
<p>O3 To ensure that building materials and roof forms are compatible with the setting and location of the site.</p>	<p>C4 Building materials and colours are recessive. Building design complements and does not detract from the visual quality and character of the neighbourhood.</p> <p>C5 Roof forms are well articulated and designed having regard to neighbouring amenity, overlooking, and the visibility of the site from North Cooper Park.</p> <p>C6 Mechanical plant equipment (including lift overruns and air conditioners) must be located internally within the principal</p>



Objectives	Controls
	<p>building in a suitably designed plant room or the like.</p> <p>C7 Air-conditioning plant or other mechanical plant equipment may only be located externally or on roofs if Council is satisfied that is:</p> <ul style="list-style-type: none"> <li>a) cannot be reasonably located elsewhere; and</li> <li>b) is suitably located, sized, enclosed, concealed and integrated into the building design (including when viewed from above) and roof form so it is:                             <ul style="list-style-type: none"> <li>i. visually discreet and unobtrusive to prevent visual impacts on the streetscape, public domain and adjoining properties; and</li> <li>ii. has acoustic attenuation to minimise noise impacts to adjoining properties.</li> </ul> </li> </ul>
<p>O4 To improve pedestrian connections from the site to Bellevue Road.</p>	<p>C8 Land between Nos.56 and 58 Bellevue Road is landscaped and maintained to provide for safe pedestrian use, subject to arrangements with Council for right of way access.</p> <p>Note: Any arrangements to create a right of way in favour of 9A Cooper Park Road would be subject to a separate application to Council for a section 88B instrument under the <i>Conveyancing Act 1919</i>.</p>
<p>O5 To ensure that vehicle and pedestrian access to the site is safe and convenient for residents and visitors.</p>	<p>C9 Where vehicular access to the site is by a single lane, traffic signals are installed to manage vehicles entering and exiting the site.</p>

# Chapter G5

## 3-9 Sisters Lane, Edgecliff

Part G ▶ Site-Specific Controls

CHAPTER G5 APPROVED ON 27 APRIL 2015  
AND COMMENCED ON 23 MAY 2015



# Chapter G5 ▶ 3-9 Sisters Lane, Edgecliff

## Contents

<b>G5.1</b>	<b>INTRODUCTION .....</b>	<b>1</b>
	G5.1.1 Background.....	1
	G5.1.2 Land where this chapter applies .....	1
	G5.1.3 Development to which this chapter applies.....	2
	G5.1.4 Objectives.....	2
	G5.1.5 Relationship to other parts of the DCP .....	2
<b>G5.2</b>	<b>CONSERVATION SIGNIFICANCE.....</b>	<b>3</b>
<b>G5.3</b>	<b>CHARACTER OF DEVELOPMENT .....</b>	<b>5</b>



## G5.1 Introduction

### G5.1.1 Background

This chapter applies to land that was formerly part of the Sisters of Charity property known as Monte Oliveto. It identifies the conservation significance of the site and its relationship to the Woollahra Heritage Conservation Area.

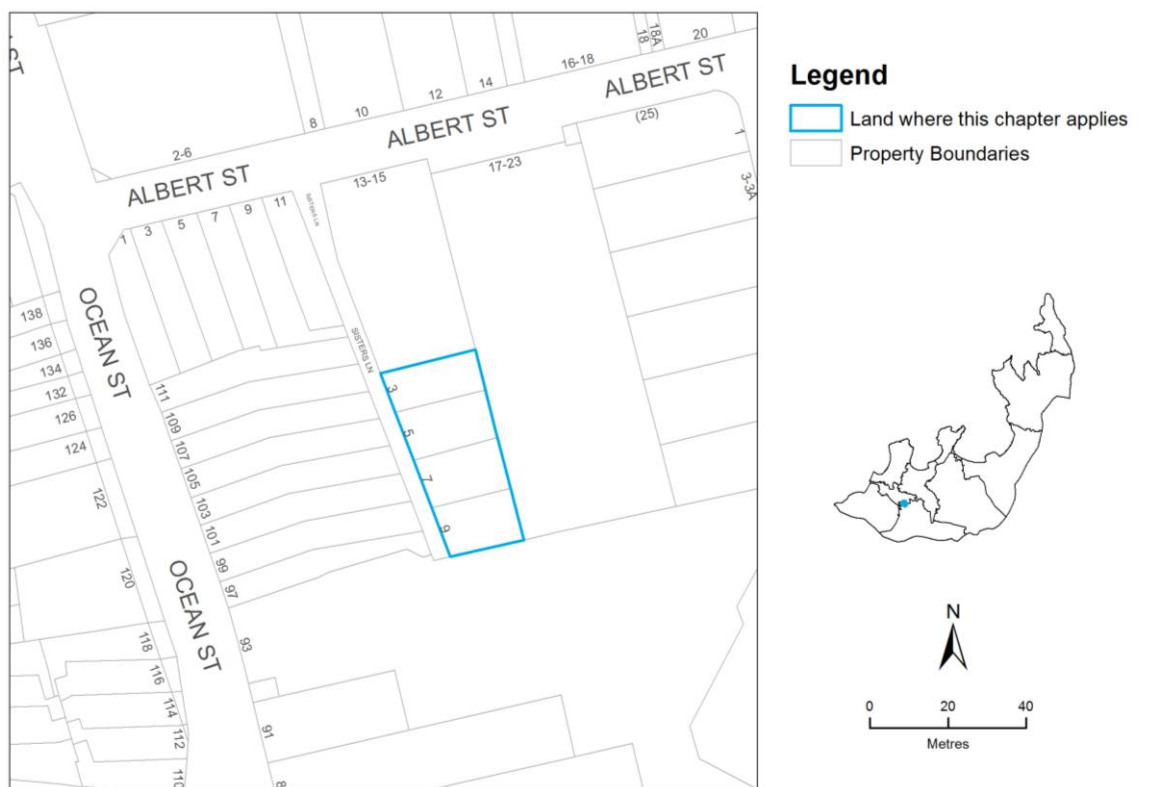
The original property at 13 Albert Street was subdivided, and the new lots at 3-9 Sisters Lane were developed for two storey contemporary terrace style housing, consistent with the controls in the original development control plan (DCP) for the site, adopted on 26 June 2000, and which commenced on 15 September 2000.

Recognising that the site is largely developed, this chapter only reflects those parts of the original site-specific DCP that may be relevant to further development on the site, such as additions and alterations.

### G5.1.2 Land where this chapter applies

This chapter applies to land identified on the map at Figure 1. The land comprises Nos.3-9 Sisters Lane, being Lots 1- 4 DP 1047567.

**FIGURE 1** Subject sites



---

### G5.1.3 Development to which this chapter applies

---

This chapter applies to development requiring consent under Woollahra Local Environmental Plan 2014 (Woollahra LEP 2014).

Given that the site has been largely redeveloped, it is likely that development would generally involve only additions and alterations.

### G5.1.4 Objectives

---

The objectives of this chapter are:

- O1 To ensure that development of the site takes place in a manner which is compatible with the character and built form of the locality.
- O2 To ensure that any development has regard to the two heritage items, “Fenton” and “Carmel” at No. 8 and 24 Albert Street in the vicinity of the site.
- O3 To ensure that any development on the site reflects its location within, and strengthens the integrity of the Woollahra Heritage Conservation Area.

### G5.1.5 Relationship to other parts of the DCP

---

This chapter is to be read in conjunction with the other parts of the DCP that are relevant to the development proposal, including:

- ▶ Part C: Chapter C2 Woollahra Heritage Conservation Area (Rosemount Precinct); and
- ▶ Part E: General Controls for All Development - this part contains chapters on Parking and Access, Stormwater and Flood Risk Management, Tree Management, Contaminated Land, Waste Management, Sustainability, Signage and Adaptable Housing.

In the event of any inconsistency between this chapter and the other chapters, this chapter prevails.

## G5.2 Conservation significance

The site lies within and on the northern edge of the Woollahra Heritage Conservation Area (HCA) as defined in Woollahra LEP 2014. There is a wide variety in the scale, style and bulk of buildings in the area.

The site formed part of property owned by the Sisters of Charity. Neither the site nor any of its buildings are listed in the schedule of heritage items contained in Woollahra LEP 2014.

Construction of the convent building commenced in 1911. It has been used for various purposes associated with the work and ministries of the Sisters of Charity.

The architectural design of the convent building is in the style known as Federation Arts and Crafts which was common in the period circa 1890 to 1915. It was built as a convent and its much altered internal layout reflects this use. In 1994 fire destroyed the whole of the upper floor, which has been restored.

The Camphor Laurel trees on the western boundary of the site are not listed as heritage items. The Camphor Laurel trees contribute to the site's natural setting by providing shade and greenery. They also provide a natural buffer to adjoining development.

As part of demonstrating the conservation value of the locality, in close proximity to the site and within the context of this northern part of the HCA, there are some 15 sites and structures identified as being of heritage significance in their own right in Woollahra LEP 2014. In fact, there are a number of fine examples of 1930s residential flat buildings in that section of Edgecliff Road from Albert Street to Ocean Street. This section of Edgecliff Road is an excellent example of a high quality streetscape.

The context of this northern edge of the precinct has been weakened by some of the styles of development in recent years. This has adversely impacted on the integrity of this section of the HCA.

The streetscape of Albert Street has a "quiet sense of enclosure" about it, notwithstanding that there is a noticeable volume of one way through traffic from Ocean Street in the west to Edgecliff Road in the east as well as vehicular movements generated by the local Catholic Parish Church and Parish Centre.

There is a "sense of entry" into Albert Street from Ocean Street due to the vegetation near the entrance of the street and the scale of the three pairs of circa 1880s two storey semi-detached terraces on the south western corner. This scale and style of development is a continuation of similar terrace style buildings from that corner along Ocean Street to the south.

The buildings along Albert Street are a mixture of single unit, one and two storey dwelling houses, terrace style housing ranging from circa 1880s to 1970s with residential flat buildings from circa 1930s together with a Church building, Parish Centre and the more recent aged care residential units.

Nos. 8 and 24 Albert Street, known as 'Fenton' and 'Carmel', which lie to the north-west and north-east of the site are heritage items in Woollahra LEP 2014.



---

The rear portions of three pairs of circa 1880s two storey terraces lie to the west of the site and are separated from the site by the narrow Sisters Lane which has a heavily treed, quiet, country lane, atmosphere created by the row of Camphor Laurels on the west side of the site.

On the west side of Sisters Lane are some ten garages to the terraces on Ocean Street; four of these have first floor additions.

A large townhouse development, in what could be described as using the architectural language of the late 20th century Sydney Regional style, adjoins the site on its eastern boundary.

On the southern boundary is a multi-storey circa 1970s residential flat/unit tower building, known as 'Rosemont Gardens'. The architectural language of this development is somewhat similar to the townhouse development on the eastern boundary.

The strength of the edge of this section of the Woollahra Heritage Conservation Area is to be found in the three, two storey terraces to the west, the fine circa 1920s to 1930s large residence on the corner of Albert Street and Quambi Place.

'Fenton' and 'Carmel', the residential developments to the north east and the Church building give context and integrity to the precinct.

The range of scale, bulk and style of existing development in the vicinity of the site provides an excellent opportunity to design an infill development that responds to its setting, strengthens the edge of the precinct and contributes to the overall integrity of the HCA.

## G5.3 Character of development

Development of the site must reflect and enhance the qualities in the area and contribute to an attractive residential environment that enhances the attributes of the Woollahra Heritage Conservation Area and heritage items in the vicinity of the site.

Development on the site is to be consistent with the built form and character of the surrounding area. Buildings on the site are to reflect the predominant built form and contribute to the variety of architectural styles of development in the area.

### Objectives

- O1 To ensure that any building is consistent with the general character of dwellings in the conservation area.
- O2 To ensure that any buildings on the site exhibit an architectural style compatible with the existing streetscape and contribute to the architectural integrity and quality of the urban amenity of the area.
- O3 To ensure that the buildings on the site are visually compatible with the surrounding development and enhance the character of the area.

### Controls

- C1 The buildings on the site must relate appropriately to the existing built form in the neighbouring area, while possessing their own architectural integrity.
- C2 The style and character of any buildings on the site must be compatible with the surrounding streetscape in the conservation area.
- C3 The principal elevations of buildings will be to Sisters Lane.
- C4 Building setbacks from Sisters Lane shall be an average minimum of 3m and reflect the need to protect trees that contribute to the natural setting of the site or to allow for replanting of vegetation which will retain the ‘country lane’ ambience of the lane.
- C5 Setbacks from Sisters Lane are to reflect the need to retain the ‘country lane’ ambience of the lane.
- C6 Building setbacks from the eastern site boundary are a minimum of 5m.
- C7 The height of any external enclosing wall is not more 7.2m to the underside of eaves, excluding that part of a wall that comprises the triangular configuration of a gable end.
- C8 Buildings have a two storey limit.
- C9 The building footprint is limited to 40% of the site area. (Building footprint means the area of land measured at finished ground level which is enclosed by the external walls of a building.)

**Chapter G6**  
**4A Nelson Street and**  
**118 Wallis Street, Woollahra**

Part G ▶ Site-Specific Controls

CHAPTER G6 APPROVED ON 27 APRIL 2015  
AND COMMENCED ON 23 MAY 2015



---

# Chapter G6 ▶ 4A Nelson Street and 118 Wallis Street, Woollahra

## Contents

<b>G6.1</b>	<b>INTRODUCTION .....</b>	<b>1</b>
	G6.1.1 Background.....	1
	G6.1.2 Land where this chapter applies .....	1
	G6.1.3 Development to which this chapter applies.....	2
	G6.1.4 Objectives.....	2
	G6.1.5 Relationship to other parts of the DCP .....	2
	G6.1.6 Relationship to other plans and documents.....	2
<b>G6.2</b>	<b>HERITAGE CONSERVATION FOR BROUGHAM AND ITS GARDENS .....</b>	<b>3</b>
	G6.2.1 Landscape elements.....	3
	G6.2.2 Archeological relics.....	3
	G6.2.3 Development to maintain the significance of Brougham .....	4
	G6.2.4 Conservation Plan.....	4
<b>G6.3</b>	<b>DEVELOPMENT CONTROLS .....</b>	<b>5</b>
	G6.3.1 The siting of development .....	5
	G6.3.2 Height .....	7
	G6.3.3 Building form .....	8
	G6.3.4 Open space and landscaping .....	9
	G6.3.5 Pedestrian access .....	11



## G6.1 Introduction

### G6.1.1 Background

This chapter applies to Brougham, its grounds and trees located at 4A Nelson Street and 118 Wallis Street, Woollahra. These properties are listed as heritage items under Woollahra LEP 2014.

The original landholding at 118 Wallis Street, formerly known as ‘Brougham Hostel’ was used as a child welfare home under the guidance of various health organisations of the State Government. That land has since been subdivided, and a seniors living development, known as Emanuel Gardens, has been developed to the west and north-west of the heritage building, Brougham.

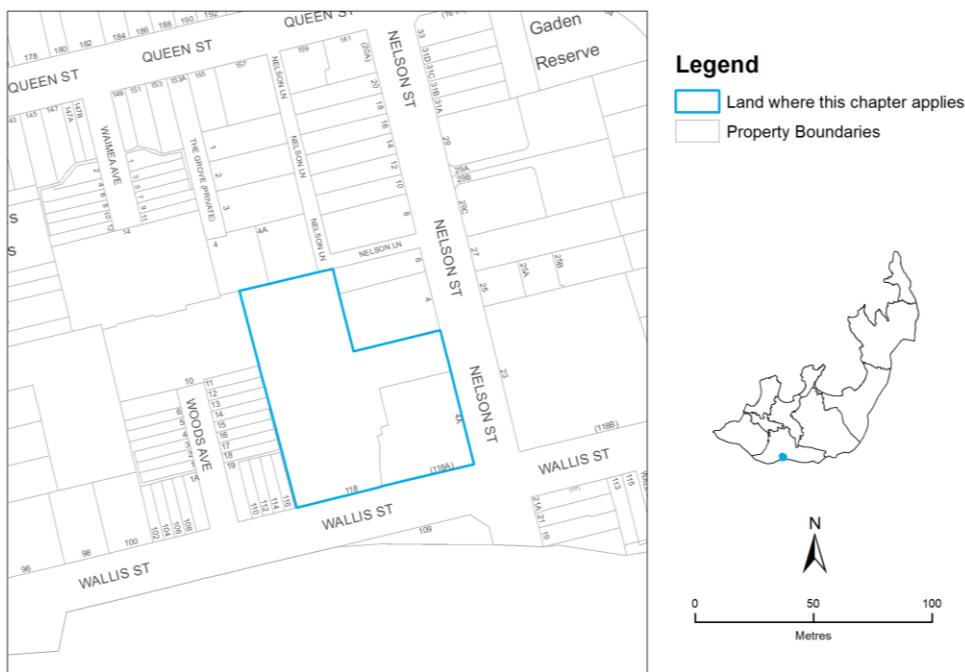
This chapter establishes parameters for any further development on either 4A Nelson Street or 118 Wallis Street to ensure that development has regard to the heritage significance of Brougham, its mature garden setting and the surrounding neighbourhood amenity.

Note: This chapter reflects the site specific development control plan adopted by Council on 22 May 1995, and which commenced on 31 May 1995.

### G6.1.2 Land where this chapter applies

This chapter applies to land identified on the map at Figure 1. The land comprises 4A Nelson Street (Lot 3 DP 1150167) and 118 Wallis Street (SP 61424) and contains the building known as ‘Brougham’ and its grounds.

**FIGURE 1** Subject sites



---

### G6.1.3 Development to which this chapter applies

---

This chapter applies to development requiring consent under Woollahra Local Environmental Plan 2014 (Woollahra LEP 2014).

### G6.1.4 Objectives

---

The objectives of this chapter are:

- O1 To ensure the conservation of Brougham and its mature garden setting.
- O2 To ensure the protection of significant trees located on the site.
- O3 To require that any new development or work is in harmony with the design, scale, form and character of Brougham and its mature garden setting.

### G6.1.5 Relationship to other parts of the DCP

---

This chapter is to be read in conjunction with the other parts of the DCP that are relevant to the development proposal, including:

- ▶ Part C: Chapter C2 Woollahra Heritage Conservation Area (Nelson Precinct); and
- ▶ Part E: General Controls for All Development - this part contains chapters on Parking and Access, Stormwater and Flood Risk Management, Tree Management, Contaminated Land, Waste Management, Sustainability, Signage and Adaptable Housing.

In the event of any inconsistency between this chapter and the other chapters, this chapter prevails.

### G6.1.6 Relationship to other plans and documents

---

#### Conservation Study

Applicants must refer to the Conservation Plan prepared by Dawson Brown and Ackert Pty. Ltd. for the Department of Planning, dated February 1991, and titled "Brougham's Hostel Woollahra".



## G6.2 Heritage conservation for Brougham and its gardens

The following controls are to apply to any development on the site occupied by Brougham and its mature 19th century gardens and have been taken from the Conservation Plan for Brougham's Hostel Woollahra (1991).

These controls have been devised to ensure that new development maintains and enhances the significance of Brougham and does not lessen the form and features of the site.

### G6.2.1 Landscape elements

The site and the setting of Brougham Hostel have undergone considerable change from original natural bushland to the establishment of a Victorian house and garden and ultimately a child welfare home.

The landscape elements considered significant are:

- ▶ two Norfolk Island Pines;
- ▶ one Camphor Laurel Tree; and
- ▶ boundary wall and entry.

The existing Brougham gardens and landscaped areas are to be conserved and enhanced. Applicants should consult the Council's Tree Management Officer prior to formulating any proposals for altering the gardens and the landscaped areas.

The extent of the brick boundary fence along both Wallis and Nelson Street, defining the boundary of the site should be retained.

### G6.2.2 Archeological relics

Council will require an applicant to engage a suitably qualified person to supervise any major building or site works carried out on the land and to advise on appropriate action relating to any relics or remnants exposed during the work.

Should any work be proposed which requires the building to be disturbed or the site to be excavated it should be preceded by an assessment of the impact of this work on the archaeological resource. This applies in particular to the possible location of the stables and the coach house for which no exact location is known at present.

The applicant is required to seek a permit under section 140 of the *Heritage Act 1977* given the possibility of unearthing relics during the excavation of the site.

---

### G6.2.3 Development to maintain the significance of Brougham

---

The cultural significance of Brougham and its setting requires that any new development must comply with the following constraints:

- ▶ the house and the existing mature 19th century plantings should be retained;
- ▶ no new additions or adjoining development should significantly conceal the form and features of the original building; and
- ▶ new works or activities within the setting of the building should be carefully located, designed and formulated having regard to their impact on the cottage and garden nature of the site.

### G6.2.4 Conservation Plan

---

Works associated with the building known as Brougham should be carried out with regard to the Significant Fabric and Graded Zones of Significance as set down in Section 6.4 of the Conservation Plan.

The house and mature plantings should be retained.

No new developments should remove any of the existing mature 19<sup>th</sup> Century planting from the site.

In any subdivision of the site the heritage significance of Brougham House must not be detrimentally affected.

## G6.3 Development controls

The following controls apply to any development on the site. In the design of any new buildings on the site, attention is to be given to the following controls.

### G6.3.1 The siting of development

---

#### Objectives

- 01 To ensure aural and visual privacy for development on the subject site and the surrounding development.
- 02 To ensure sunlight and daylight access for development on the site and neighbouring land.
- 03 To promote a building scale and form which is compatible with the surrounding development.
- 04 To ensure compatibility with the character of the streetscape.
- 05 To integrate new development which does not dominate the scale of Brougham and its garden setting and is in sympathy with the curtilage established.

#### Controls

##### *Development and the building curtilage*

Development should be sited outside the building curtilage established for Brougham and the mature garden setting, which includes two Norfolk Island Pines that are listed as heritage items in Woollahra LEP 2014. The curtilage is identified in Figure 2 below. The western boundary of the curtilage is based on the tree preservation zones for the Norfolk Island Pines, minus the built form at the north-western corner.

##### *Development to Wallis Street*

Development to Wallis Street should be suitably sited and articulated and continue the building lines and proportions of the adjoining development.

The minimum setback to Wallis Street from any point on the development should be 2m from the property boundary.

A minimum setback of 6m from the west and north-west boundaries of the site is required for all development.

In designing the development the applicant should have regard to both the heritage significance of properties along the Woods Avenue boundary and the residential amenity of the neighbouring property. The applicant should demonstrate that setbacks to all boundaries have taken into account the setbacks of adjoining properties and the amenity of the neighbourhood.

**FIGURE 2** Building curtilage

The curtilage for the building and its landscape setting for Brougham, at 4A Nelson Street and 118 Wallis Street



---

## G6.3.2 Height

---

### Objectives

- 01 To retain access to mid-winter sunshine on-site and to all neighbouring properties.
- 02 To maintain aural and visual privacy on the subject site and the surrounding development.
- 03 To ensure compatibility with the scale and the built form of the surrounding development to encourage a cohesive skyline.
- 04 To maintain a street facade of human scale.
- 05 To permit variations in building height to ensure compatibility with Brougham and the surrounding neighbourhood.

### Controls

The height and roof pitch of new development should be consistent with the surrounding height and roofline of neighbouring development, particularly where new development fronts Wallis Street.

Development should be proportioned and stepped back in height from the street to achieve a human scale at street level and to continue the building lines established by adjoining development to introduce some scaled rhythm to the streetscape.

All new development should be the result of careful analysis of surrounding buildings and sympathetic interpretation of their design elements and the heritage significance of Brougham and the adjoining properties. Where development extends towards Brougham, the building height should be suitably scaled to relate to the height of Brougham. In this respect development should be stepped upwards in height back from Brougham.

The design of all external walls must take into account the wall height of adjoining buildings and apply suitable setbacks to the building to respect the built form of the surrounding development and amenity.

---

### G6.3.3 Building form

---

#### Objectives

- O1 To require that any new development or work is compatible with the design, scale, form and character of Brougham and its garden setting and surrounding development.
- O2 To ensure that new development does not significantly conceal the form and features of Brougham and its garden setting.
- O3 To protect and enhance the streetscape amenity.
- O4 To promote a high standard of building design and energy efficiency.

#### Controls

New development must take into account the style, scale, location, use of balconies or verandahs and the proportions of the facades as they relate to the historical significance and architectural features of Brougham and the heritage significance of all the buildings which adjoin the site on the south-western side of Wallis Street.

A design approach which is sympathetic rather than purely imitative is required.

New development should ensure that the existing character and nature of the street remains intact and introduces some scaled rhythm to the streetscape.

All external walls which face Brougham are to ensure that a sympathetic building form in terms of height and dimension is achieved. Furthermore, any development which faces Brougham must relate to and enhance the landscape setting established by the curtilage.

Any walls which directly face Brougham should be suitably designed and landscaped to blend and soften their appearance and such walls should be stepped back and proportioned in height to relate to the external wall height of Brougham and to respect the heritage significance of Brougham and its setting.

All external development components including garages, ancillary structures as well as side and rear facades should exhibit unity of building form and architectural detailing.

---

### G6.3.4 Open space and landscaping

---

#### Objectives

- O1 To ensure the retention and enhancement of the mature 19th century gardens and setting of Brougham because of their heritage significance and to achieve the following:
  - a) the creation of a buffer between Brougham and the proposed development;
  - b) the provision of a reasonable level of privacy for all users of the site; and
  - c) the provision of a landscaped setting that could act as a link to integrate Brougham and new development.
- O2 To ensure the provision of outdoor areas which are adequately sized, proportioned and located, for the use and enjoyment of the occupants of Brougham and the new development.
- O3 To promote the streetscape amenity.
- O4 To ensure the significant enhancement and retention of perimeter trees to screen and soften the impact of new development on adjoining properties.
- O5 To retain all significant trees on site.
- O6 To maintain sunlight and daylight penetration on the subject land and adjoining properties.

#### Controls

- C1 The 19th century mature gardens in the centre of the site should be retained as a focus and enhanced to provide an appropriate setting to link and formalise the space between Brougham and new development.
- C2 A landscaped buffer must be established between all new development on site and Brougham and its garden setting. All hard surfaces (except those already in existence) must be incorporated into a landscape setting.
- C3 The two Norfolk Island Pines and the Camphor Laurel Tree (as identified in Section 6.2.1 of this chapter) are to be retained. The mature gardens are also to be retained and may be added to subject to a detailed heritage landscaping plan being approved by Council.
- C4 All significant trees should be retained on site.
- C5 Suitable landscaping shall be introduced on site to soften all solid walls which directly face Brougham.
- C6 Where it is determined that a tree is to be removed, it must be replaced with a suitable tree to the satisfaction of Council's Tree Officer.
- C7 A landscape Heritage Management Plan and Impact Statement for the overall Building Curtilage heritage garden is to be submitted with any development application proposing landscaping works.

---

Notes:

- i) Applicants should consult Council's Tree Officer prior to formulating a landscape plan for the site.
- ii) A detailed tree survey is required and a full appraisal of the present condition of the trees and the likely impact of future development on all trees. All trees listed as significant must be retained and protected during construction. A qualified arborist must thoroughly inspect all trees (including all trees listed as significant) to determine the health and stability/safety for retention in the long term. In order to retain trees in a stable and healthy manner, it is generally required (except where determined by a tree surgeon) that no excavation take place within the dripline or canopy spread of the trees. However, it must be recognised that for trees such as Norfolk Island Pines that the tree roots would be expected to substantially exceed the dripline of the trees in order to stabilise the tree. Further, no change in levels would be acceptable above the existing ground level at the trees root system.
- iii) The row of immature Camphor Laurel trees on the Woods Avenue boundary are required to be inspected by an arborist to determine whether their long term retention is viable. Where it is determined that a tree is to be removed, it must be replaced with a suitable tree to the satisfaction of Council's Tree Officer. Selective and gradual removal of trees is preferred in order to minimise loss of amenity to the properties in Woods Avenue. Replacement species shall be of a super-advanced plant stock (minimum 100 litre container).



---

### G6.3.5 Pedestrian access

---

#### Objectives

- O1 To provide a formal and historical link between Brougham and the curtilage;
- O2 To restore the setting and curtilage of Brougham and recognise opportunities to do so;
- O3 To enhance the use and enjoyment of Brougham by restoring the access to the traditional garden setting for recreational purposes;
- O4 To ensure that pedestrian access is suitably located, landscaped and designed in context with the heritage items; and
- O5 To provide those people entitled to access Brougham, safe and adequate access to all parts of the Brougham curtilage;
- O6 To recognise the distinction between the visual curtilage and the area used for recreation;
- O7 To maintain the landscape and the garden setting with the traditional balance of vegetation and open areas.

#### Controls

- C1 Pedestrian access should be maintained from Brougham [Lot 3 DP 1150167] to all parts of the traditional Brougham curtilage.
- C2 Pedestrian access should be designed to formally link Brougham and the curtilage and be suitably landscaped.
- C3 Access to area C in DP 1009223 for recreational purposes to be restored for the benefit of Brougham.
- C4 The inventory sheet for Brougham to guide future development.

# Chapter G7 Former Royal Women's Hospital, Paddington

Part G ▶ Site-Specific Controls

CHAPTER G7 APPROVED ON 27 APRIL 2015  
AND COMMENCED ON 23 MAY 2015



# Chapter G7 ▶ Former Royal Women’s Hospital, Paddington

## Contents

<b>G7.1</b>	<b>INTRODUCTION .....</b>	<b>1</b>
	G7.1.1 Background.....	1
	G7.1.2 Land where this chapter applies .....	1
	G7.1.3 Development to which this chapter applies.....	2
	G7.1.4 Objectives.....	2
	G7.1.5 Relationship to other parts of the DCP .....	3
<b>G7.2</b>	<b>MASTER SITING PLAN .....</b>	<b>4</b>
<b>G7.3</b>	<b>OXFORD STREET FRONTAGE .....</b>	<b>5</b>
	G7.3.1 Context statement.....	5
	G7.3.2 Urban design principles .....	6
<b>G7.4</b>	<b>HERITAGE STANDARDS .....</b>	<b>7</b>
<b>G7.5</b>	<b>BUILT FORM GUIDELINES .....</b>	<b>9</b>
<b>G7.6</b>	<b>ARCHITECTURAL STANDARDS.....</b>	<b>12</b>
<b>G7.7</b>	<b>LANDSCAPE MANAGEMENT PLAN .....</b>	<b>15</b>



## G7.1 Introduction

### G7.1.1 Background

This chapter applies to land in Paddington previously occupied by the Royal Hospital for Women. The hospital played a major part in the history of Paddington, and its site together with certain buildings and structures form important elements of the Paddington conservation area. The hospital closed in the mid 1990s and the owners of the property, the Benevolent Society, sought the rezoning of the site to allow for redevelopment.

In November 1995, Council rezoned the site to a combination of residential, commercial and open space zones. Council then adopted a development control plan (DCP) for the site, which commenced on 24 January 1997. That DCP identified street dimensions, building siting, building setbacks, materials, building configuration, fences, parking, energy efficiency, heritage conservation and landscaping. The site was redeveloped consistent with the intent of the rezoning and the DCP.

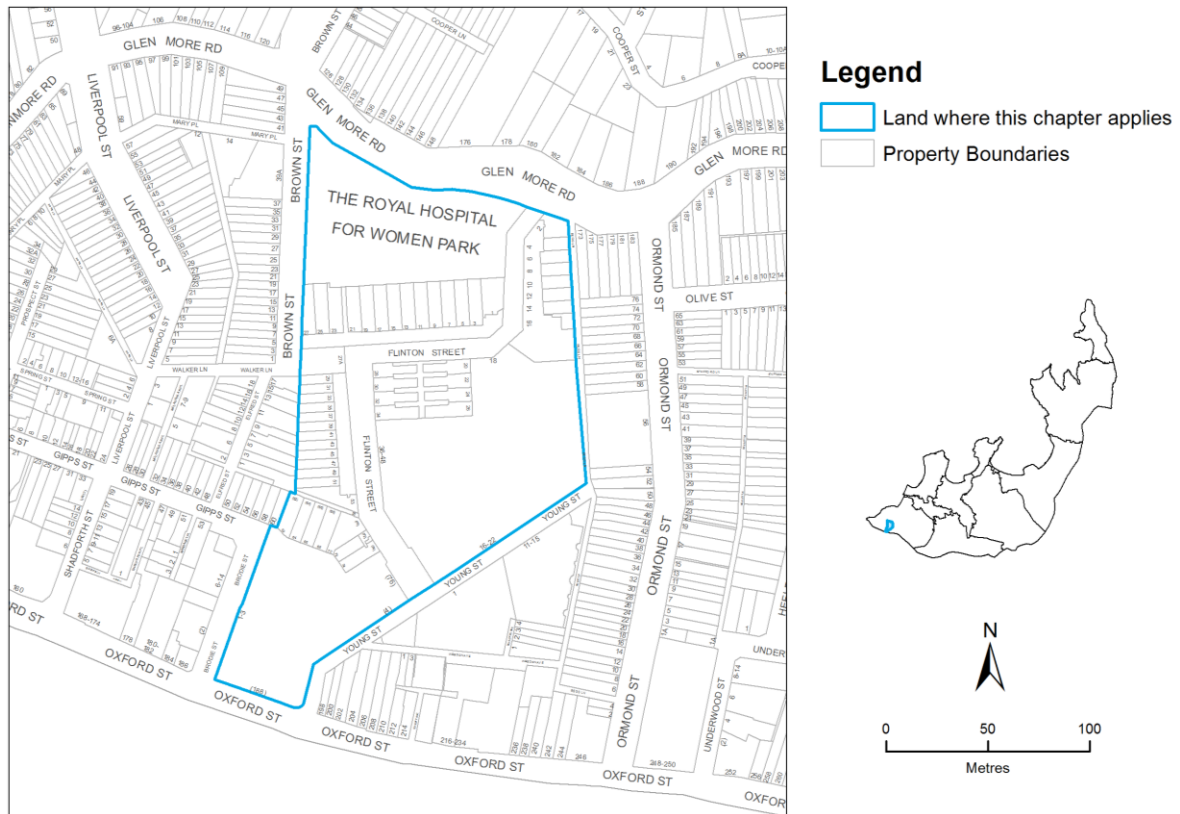
Recognising that the site is largely developed, this chapter only reflects the following parts of the original site specific DCP that may be relevant to further development on the site, such as additions and alterations:

- ▶ master siting plan;
- ▶ context statement and urban design principles;
- ▶ heritage standards;
- ▶ architectural standards;
- ▶ built form guidelines; and
- ▶ landscape management plan.

### G7.1.2 Land where this chapter applies

This chapter applies to various lots in Paddington as identified on the map at Figure 1.

The lots are: SP 64257 (1-3 Brodie Street and 4 Young Street), Lot 56 & 57 SP 87117, SP 64558 (8, 16-22 Young Street, 18 and 36-48 Flinton Street), SP 64396 (62-74 Gipps Street), Lot 1-7 DP 1019806 (62 -74 Gipps Street), SP 65254 (20-34 Flinton Street), SP 65255 (1-27 Flinton Street), Lot 1-14 DP 1026156 (1 -27 Flinton Street), Lot 1-8 DP 1026153 (20-32 Flinton Street), Lot 1- 13 DP 1024561 and SP 65095 (29-53 Flinton Street), Lot 2 DP 1029153 (27A Flinton Street), Lot 1-8 DP 1049074 (2-16 Flinton Street), SP 69697 (2-16 Flinton Street) and Lot 8 DP 106623 (2 Flinton Street).

**FIGURE 1** Subject sites

### G7.1.3 Development to which this chapter applies

This chapter applies to development requiring consent under Woollahra Local Environmental Plan 2014 (Woollahra LEP 2014).

Given that the site has been largely redeveloped, it is likely that development would generally involve only additions and alterations.

### G7.1.4 Objectives

The objectives of this chapter are:

- 01 To ensure a high quality of development and compatible relationship between development on the site and development on adjoining properties.
- 02 To conserve items of heritage significance.
- 03 To achieve a high quality of public spaces.

### **G7.1.5 Relationship to other parts of the DCP**

---

This chapter is to be read in conjunction with the other parts of the DCP that are relevant to the development proposal, including:

- ▶ Part C: Chapter C1 Paddington Heritage Conservation Area
- ▶ Part E: General Controls for All Development - this part contains chapters on Parking and Access, Stormwater and Flood Risk Management, Tree Management, Contaminated Land, Waste Management, Sustainability, Signage and Adaptable Housing.

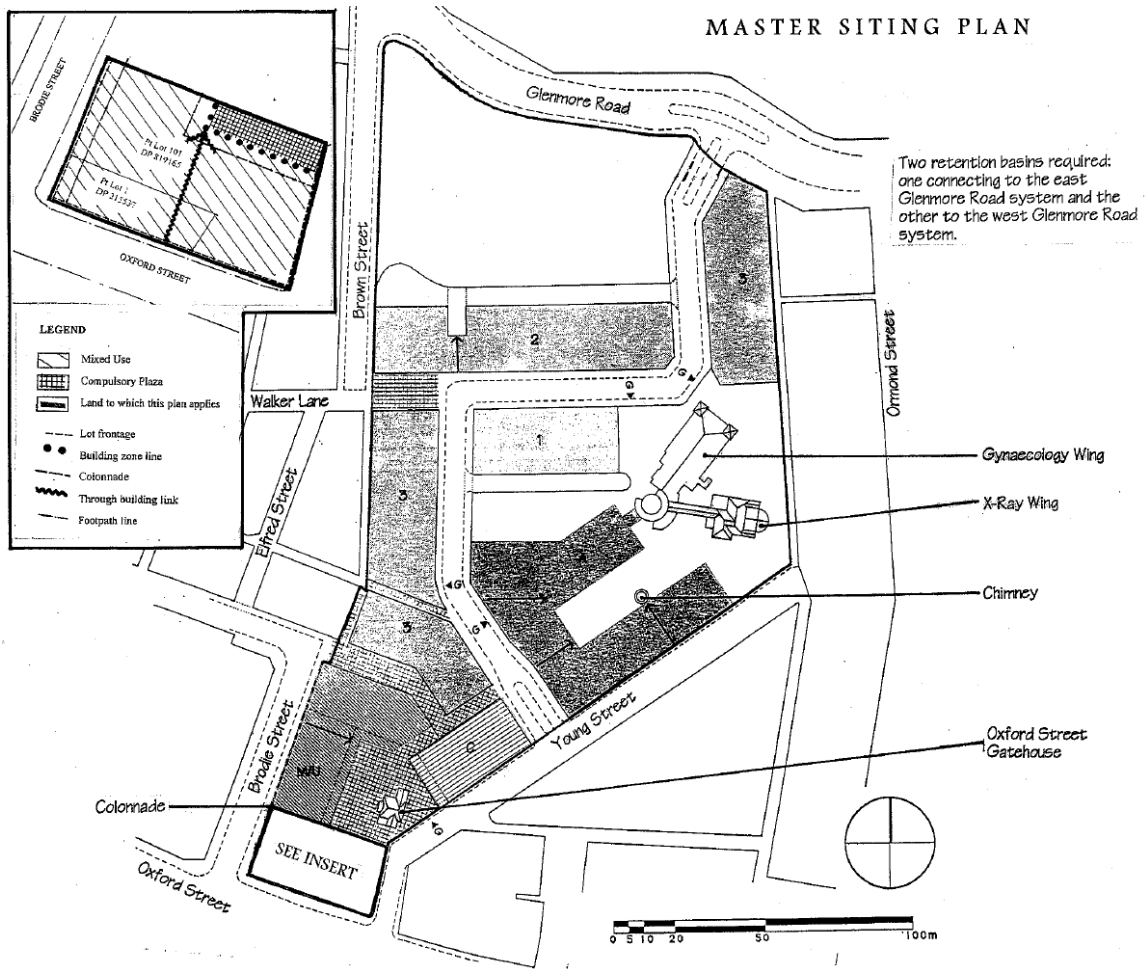
In the event of any inconsistency between this chapter and the other chapters, this chapter prevails.



## G7.2 Master siting plan

The master siting plan shows the location of building types, public open space and roadways.

The location of these should not be altered unless there is a need to reduce or avoid adverse environmental impact or unless it can be demonstrated that environmental and conservation benefits for development and areas on the site and for development and areas outside the site will be achieved.



### LEGEND

- 1 Terrace Type 1
- 2 Terrace Type 2
- 3 Terrace Type 3
- Apartment
- Mixed Use
- Commercial
- Compulsory Plaza
- Retained Historic Building
- G Suggested Underground Carpark Entry
- Lot frontage
- Building zone line
- Colonnade
- Through building link
- Footpath line

## G7.3 Oxford Street frontage

### G7.3.1 Context statement

---

#### Character zones

Oxford Street, between Queen Street to the east and Boundary Street to the west, may be divided into three distinct areas, or 'character zones'.

From the east, the first area is Paddington, which extends from Queen Street through to the Paddington Town Hall and the post office. Paddington is dominated by the small retail frontages along the northern side of the road, with the southern side being a combination of civic uses (churches/school) and retail. There are a few modern intrusions, such as the OTC/Telstra building. The western end of this section is terminated by a significant civic grouping of buildings, including Juniper Hall, the post office, the Town Hall and a small park.

The second area is known as 'Paddinghurst' and extends from the town hall and the post office down to Glenmore Road. Paddinghurst is the most diverse area of the three character zones. It is dominated on the southern side by Victoria Barracks for most of its length. The northern side is a broad mixture of building types. There are commercial shopfront terraces, residential terraces converted for retail and commercial uses, commercial buildings, a petrol station, modern housing, the hospital and the Paddington RSL. The latter four represent modern intrusions into a traditional streetscape.

The third area is from Glenmore Road to Boundary Street and is known as Darlinghurst. West of Glenmore Road, in Darlinghurst, the traditional small retail frontages start again on both sides on the street, though there are a few larger buildings on the southern side.

#### Oxford Street building typology

There are three distinct building typologies along Oxford Street:

- ▶ the terrace (commercial or residential);
- ▶ the 19th century/early 20th century civic/commercial buildings; and
- ▶ the modern commercial/residential development.

The commercial/residential terrace is distinguished by its long and narrow blocks, which are built to the boundary at the front, and usually also to both sides. Usually, shopfronts are located at the ground floor with offices, studios or residential above.

The 19th century/early 20th century civic/commercial developments are represented by hotels, such as the Imperial or Greenwood Tree Hotels, and the post office and Town Hall. The forms are longer, rectangular and well detailed, with a vertical emphasis above the awning. The commercial and hotel buildings usually have an awning.

---

Modern commercial/residential development exhibits a wide range of building typologies, which are grouped together, as their form and relationship to the street is similar. These are usually large in scale vertically (for example: OTC/Telstra, Oxford Towers), or large in scale horizontally (RSL, Apartments - No. 160). Architecturally, these modern buildings do not relate to earlier surrounding development.

### Heights and skyline

The commercial/residential terrace form is the most common building type along Oxford Street. They are usually two storeys in height, being around 10m to the ridge/top of the parapet. These form a consistent skyline, punctuated by common walls or chimneys. The roof form is either a skillion behind a parapet or pitched roof.

The 19th century/early 20th century civic/commercial buildings punctuate the terraces as elements that visually stand out more among terraces. These buildings are generally higher, approximately 13m, with skyline elements such as towers and parapets, which then exceed the 13m height. The Town Hall and the Imperial Hotel are good examples of towers on corners which provide distinct landmarks along Oxford Street. The post office and Greenwood Tree Hotel are examples of buildings with strong parapets that add variety to the skyline of Oxford Street.

Modern development generally lacks the detail to the skyline, often presenting a flat plane to the street, as seen in the Oxford Towers and OTC/Telstra buildings.

### G7.3.2 Urban design principles

---

Development along the Oxford Street frontage is to adhere to the following urban design principles:

- ▶ Development shall align with the Oxford Street frontage.
- ▶ Development shall be modulated to break the continuous façade and to give the appearance of a number of building sections.
- ▶ The built form of new development shall reflect the civic/commercial building typology of Oxford Street.
- ▶ The ground floor of development along Oxford Street is to provide an active retail element.
- ▶ Development is to continue the skyline character of Paddington with its undulating parapets, providing interest and identity, using specific details and features.
- ▶ A distinctive gateway feature shall be provided on the ground floor level which links Oxford Street with the internal courtyard.

**G7.4 Heritage standards**

	Gynaecology building	X-ray wing	Gate house	Miscellaneous items
<b>Form and use</b>	<ul style="list-style-type: none"> <li>► Maintain existing form. No new major additions permitted. Remove the 1940s addition and other smaller additions and accretions</li> <li>► Building is suitable for conversion to residential units, commercial suites. It is possible to have a child care on the ground floor</li> </ul>	<ul style="list-style-type: none"> <li>► Maintain existing form. No new major additions permitted</li> <li>► Building is suitable for conversion to residential units, commercial suites. It is possible to have child care on the ground floor (with gynaecology wing)</li> </ul>	<ul style="list-style-type: none"> <li>► Remove recent additions and take back to original gatehouse form</li> <li>► No new major additions permitted</li> </ul>	<ul style="list-style-type: none"> <li>► Chimney - retain in place with no alterations</li> <li>► Repair, repoint and clean brick of chimney</li> <li>► The pillars and crowns at the Oxford Street entry should be reused in an entryway to the site</li> <li>► Brick and render side fences to Begg, Young and Brown Street to be retained to distinguish the boundaries, minimal intervention only</li> <li>► Remnant sandstone blocks that are used as a wall to the carpark behind Hardwick House to be reused in the landscaping of the site</li> <li>► 1820 memorial stone currently fixed to Macquarie House is to be reused on the building that the Benevolent Society decides to occupy on the site</li> </ul>
<b>External building walls</b>	<ul style="list-style-type: none"> <li>► Repair, repoint and clean brick and stonework</li> <li>► Rationalise services and repair locations where removed</li> </ul>	<ul style="list-style-type: none"> <li>► Repair, repoint and clean brick and stone work</li> <li>► Rationalise services and repair locations where removed</li> </ul>	<ul style="list-style-type: none"> <li>► Repair, repoint and clean brick and stonework</li> <li>► Rationalise services and repair locations where removed</li> </ul>	
<b>Roofs and gutters</b>	<ul style="list-style-type: none"> <li>► Repair roofing and slating where needed, replacing elements if needed</li> <li>► Repair and replace roof plumbing where needed</li> </ul>	<ul style="list-style-type: none"> <li>► Repair roofing and slating where needed, replacing elements if needed</li> <li>► Replace flat roof on circular turret with a reconstruction of the original</li> <li>► Repair and replace roof plumbing where needed</li> </ul>	<ul style="list-style-type: none"> <li>► Repair roofing where needed, replacing elements if needed</li> <li>► Repair and replace roof plumbing where needed</li> </ul>	
<b>Windows, doors, balconies, verandahs</b>	<ul style="list-style-type: none"> <li>► Return the verandahs to their original open configuration, maintain them as open space to the internal use</li> <li>► Reinststate and maintain the external timber finishes to the verandahs</li> <li>► Maintain existing timber windows</li> </ul>	<ul style="list-style-type: none"> <li>► Maintain openings with their timber shutters along connecting passageway</li> <li>► Provide new exits (stairs/lift) either integrated in or as a discrete new structure</li> <li>► Maintain and repair old stairs and lift</li> <li>► Maintain existing timber windows</li> </ul>	<ul style="list-style-type: none"> <li>► Reinststate the original front porch</li> <li>► Maintain existing timber windows</li> </ul>	
<b>Internal finishes</b>	<ul style="list-style-type: none"> <li>► Retain all early internal finishes where they remain</li> <li>► Return wards to open form if practical with the proposed use</li> </ul>	<ul style="list-style-type: none"> <li>► Retain all early internal finishes where they remain</li> <li>► Retain marble stairs in worn condition as a feature of the circulation space</li> </ul>	<ul style="list-style-type: none"> <li>► Retain all early internal finishes where they remain</li> </ul>	

## General

- ▶ Development does not prevent the site being read as a whole.
- ▶ Any building or sections of buildings to be removed, including original fittings, are to be documented as part of the development process (as specified in the Burra Charter) prior to removal, and that the recording be included in any interpretation of the site.
- ▶ Future structures shall be designed and sited in such a way that they will not detract from the heritage significance of Paddington, the site, or any buildings or structures to be retained.
- ▶ An interpretation of the site, incorporating a history of the property, shall be included in any future development, and displayed on the site. The interpretation shall cover the entire period of use of the site.
- ▶ Brick and render side fences to be retained to distinguish the boundaries, minimal intervention only.

## G7.5 Built form guidelines

All measurements are in metres unless stated otherwise.

Terrace Type 1	Terrace Type 2	Terrace Type 3
<p><b>Building use</b></p> <ul style="list-style-type: none"> <li>► Uses of the buildings shown here are in conformance with the zoning</li> </ul>		
<p><b>Building siting</b></p> <ul style="list-style-type: none"> <li>► Buildings shall be located on lots relative to the property lines with setbacks as shown</li> <li>► Setbacks from street frontages should occur only for groups of two or more buildings</li> </ul>		
<p><b>Permitted variations</b></p> <ul style="list-style-type: none"> <li>► Balconies, verandahs and bay windows are permitted in the areas shown</li> <li>► Terraces may vary in width and setback</li> </ul>		
<p><b>Building height</b></p> <ul style="list-style-type: none"> <li>► Maximum heights are set in the LEP and are shown here diagrammatically</li> <li>► Height is defined as being the greatest distance measured vertically from any point on the building to the existing ground level</li> </ul>		

Terrace Type 1	Terrace Type 2	Terrace Type 3
<p><b>Parking</b></p> <ul style="list-style-type: none"> <li>▶ Parking spaces will be provided within the areas shown here</li> </ul>		

Apartments	Commercial	Mixed use
<p><b>Building use</b></p> <ul style="list-style-type: none"> <li>▶ Uses of the buildings shown here are in conformance with the zoning</li> <li>▶ Shopfronts to be on the ground floor at street level</li> </ul>		
<p>Note: The labeling of buildings in the DCP will not preclude variation of the nature and mix of uses in the Business 3(c) zone under the LEP. This note does not form part of the DCP adopted by the Council.</p>		

**Building siting**

- ▶ Buildings shall be located on lots relative to the property lines with setbacks as shown
- ▶ Setbacks from street frontages should occur only for groups of two or more buildings

THE SETBACKS SHOWN HERE ARE MINIMUM SETBACKS

THE SETBACKS SHOWN HERE ARE MINIMUM SETBACKS

THE SETBACKS SHOWN HERE ARE MINIMUM SETBACKS

**Permitted variations**

- ▶ Balconies, turrets, bay/dormer windows, awnings and colonnades are permitted in the areas shown
- ▶ Awnings shall be along street frontages and colonnades around the plaza

TURRETS, BAY/DORMER WINDOWS.

TURRETS, BAY/DORMER WINDOWS

ALLOTMENT BOUNDARIES

AWNING

COLONNADE

Apartments	Commercial	Mixed use
<p><b>Building height</b></p> <ul style="list-style-type: none"> <li>▶ Maximum heights are set in the LEP and are shown here diagrammatically</li> <li>▶ Height is defined as being the greatest distance measured vertically from any point on the building to the existing ground level</li> </ul> <div style="display: flex; justify-content: space-around; align-items: flex-start;"> <div data-bbox="215 492 582 672"> <p>21.5 16.5 APARTMENT BUILDINGS ALONG YOUNG ST. (REFER TO THE LEP)</p> </div> <div data-bbox="614 492 973 672"> <p>15</p> </div> <div data-bbox="1005 492 1380 672"> <p>16.5 10 OXFORD ST (REFER TO COUNCIL RESOLUTION DATED 26 AUGUST 1996 REGARDING PROPOSAL TO CONSIDER INCREASED HEIGHT TO 12 M)</p> </div> </div>		
<p><b>Parking</b></p> <ul style="list-style-type: none"> <li>▶ Parking spaces will be provided within underground garages, accessed by ramp</li> <li>▶ The underground car park along Oxford Street shall set back from the underground transmission easement, unless the easement is relocated</li> </ul> <div style="display: flex; justify-content: space-around; align-items: center;"> <div data-bbox="207 918 359 1086"> <p>PARKING UNDERGROUND ENTERED VIA RAMP</p> </div> <div data-bbox="375 918 813 1086"> <p>PARKING UNDERGROUND ENTERED VIA RAMP</p> </div> <div data-bbox="829 918 1380 1086"> <p>OXFORD ST. TRANSMISSION LINE EASEMENT YOUNG ST. PARKING UNDERGROUND ENTERED VIA RAMP</p> </div> </div>		



## G7.6 Architectural standards

	Materials	Configurations	Energy efficiency	General
<b>External building walls</b>	<ul style="list-style-type: none"> <li>▶ Rendered paint finish for terraces.</li> <li>▶ Face brick and stucco shall be used for the apartments.</li> <li>▶ Stone/detailing around windows, parapets shall be used for the apartments, along the lines of the existing gynaecology wing</li> <li>▶ Mixed use buildings fronting Oxford Street               <ul style="list-style-type: none"> <li>– rendered paint finish</li> </ul> </li> </ul>	<ul style="list-style-type: none"> <li>▶ Terraces: Common walls to be clearly articulated, expressing the rhythm of the terrace form</li> <li>▶ Apartments/commercial:               <ul style="list-style-type: none"> <li>– window sills, floor levels to be clearly articulated;</li> <li>– Windows to be set into façade to provide a sense of depth; and</li> </ul> </li> <li>▶ Facades to be detailed, e.g. brick/stone banding</li> <li>▶ Mixed use buildings fronting Oxford Street               <ul style="list-style-type: none"> <li>– modulate façade to give appearance of a number of sections</li> <li>– provide for a distinctive gateway feature on the ground floor level which links Oxford Street with the internal courtyard</li> </ul> </li> </ul>	<ul style="list-style-type: none"> <li>▶ Southern walls - minimise openings</li> <li>▶ Northern walls - maximize openings, while providing shade from summer sun to minimise cooling costs</li> <li>▶ Provide appropriately insulated walls</li> </ul>	<ul style="list-style-type: none"> <li>▶ The materials used in the apartments should be sympathetic with the retained gynaecology and x-ray wings</li> </ul>
<b>Garden walls and fences</b>	<ul style="list-style-type: none"> <li>▶ Cast iron/steel palisade fences with iron spearheads</li> <li>▶ Timber pickets</li> <li>▶ Base plinths and garden walls: stone, and pigmented renders. Rendered paint suitable for walls only</li> </ul>	<ul style="list-style-type: none"> <li>▶ Front fences and/or walls: &lt;1.2m high</li> <li>▶ Side fences: maximum 1.8m</li> <li>▶ A degree of privacy should be maintained between the yards of terraces</li> </ul>	<ul style="list-style-type: none"> <li>▶ Recycled stone and timbers shall be used where possible</li> </ul>	<ul style="list-style-type: none"> <li>▶ Consider the historic character of fencing</li> <li>▶ Consider the visual impact of fencing and walls</li> <li>▶ Investigate semi-transparent fencing and hedging as alternatives</li> <li>▶ Low retaining walls can double as fences</li> </ul>

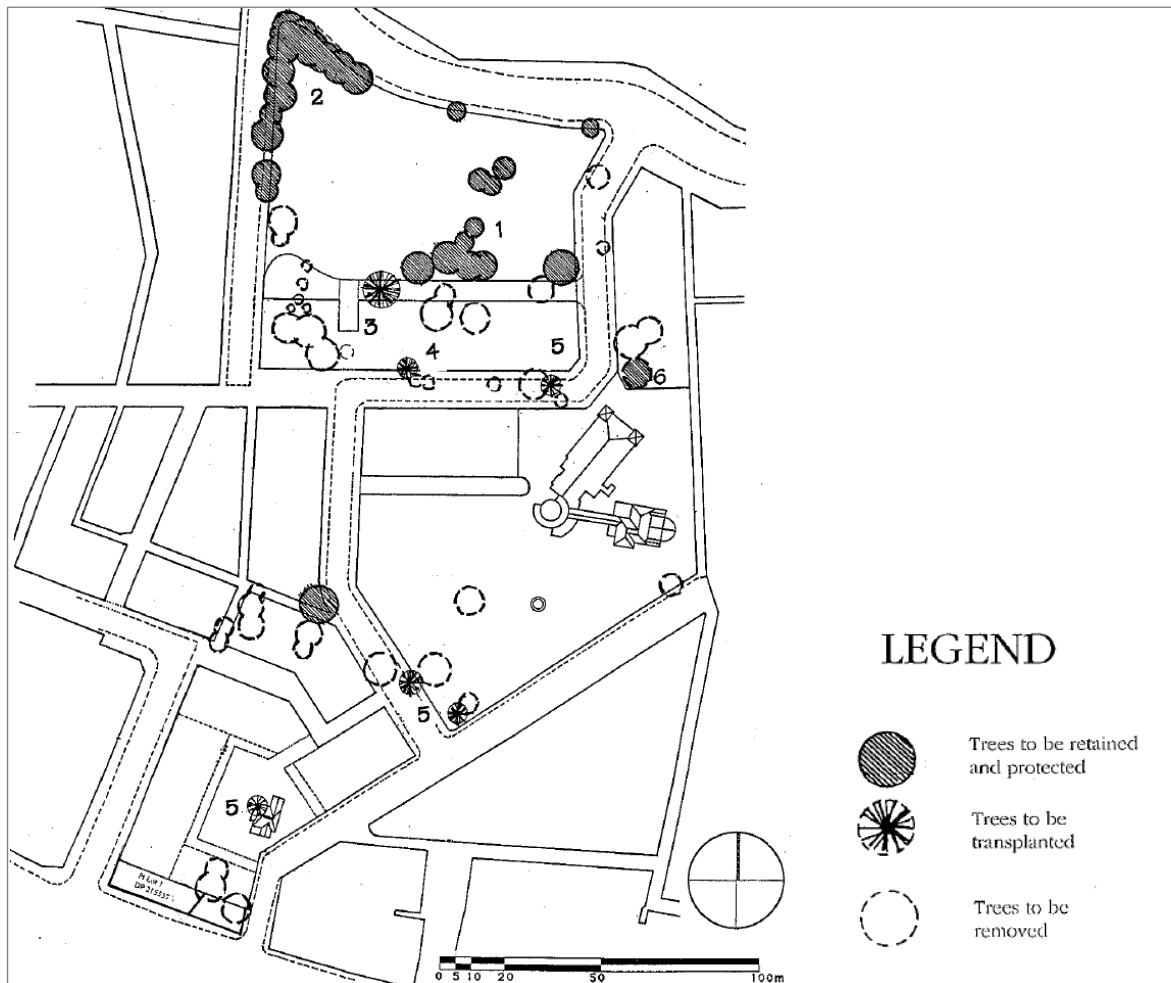
<p><b>Balconies, verandahs, etc.</b></p>	<ul style="list-style-type: none"> <li>▶ Balcony railings to be sympathetic with fencing</li> <li>▶ Appropriate decorative timberwork important</li> <li>▶ Curved roof form for balconies is an important element within Paddington</li> <li>▶ Traditional steel or timber posted awnings on the commercial/mixed use buildings</li> </ul>	<ul style="list-style-type: none"> <li>▶ Balconies to be clearly expressed</li> <li>▶ Bay windows may be used in place of balconies in apartments and commercial buildings, or end terraces</li> <li>▶ Turrets permitted centrally or in corners of apartment or commercial buildings</li> <li>▶ Mixed use buildings fronting Oxford Street:             <ul style="list-style-type: none"> <li>– modulate façade to give appearance of number of sections</li> <li>– provide for a distinctive gateway feature on the ground floor level which links Oxford Street with the internal courtyard</li> </ul> </li> </ul>	<ul style="list-style-type: none"> <li>▶ Balconies to face north where possible</li> </ul>	
<p><b>Roofs and gutters</b></p>	<ul style="list-style-type: none"> <li>▶ Corrugated iron/Colorbond (especially for verandahs etc.), slate or imitation slate</li> <li>▶ Important roof elements in Paddington include ornate gables and finials, as well as parapets and chimneys</li> <li>▶ Gutters, flashing and fascias shall be used for the Paddington urban conservation area</li> </ul>	<ul style="list-style-type: none"> <li>▶ Terraces may have either a parapet and roof or pitched roof of approx. 40°</li> <li>▶ Apartments and commercial buildings may use hipped roof forms of approx. 40°</li> <li>▶ Appropriately proportioned dormer windows permitted in all building types</li> <li>▶ Quad, half round or ogee gutter profiles suitable, but not modern profiles such as fascia gutters. Downpipes to be of circular section</li> </ul>	<ul style="list-style-type: none"> <li>▶ Collection of rain water for watering gardens, especially around the apartments</li> <li>▶ Possible recycling of grey water</li> </ul>	<ul style="list-style-type: none"> <li>▶ Roof forms should relate to those traditionally found in Paddington, as well as surrounding buildings</li> <li>▶ Use of roof space is desirable</li> <li>▶ Opposite windows in apartments should be staggered so as not to face each other, to preserve privacy</li> </ul>
<p><b>Windows and doors</b></p>	<ul style="list-style-type: none"> <li>▶ The following are permitted:             <ul style="list-style-type: none"> <li>– painted timber (preferred)/ aluminium (only where sufficient depth and width to frame and glazing elements;</li> <li>– clear glass; and</li> <li>– leadlight in doors, or small feature windows</li> </ul> </li> </ul>	<ul style="list-style-type: none"> <li>▶ size, location and proportion should relate to those found in Paddington on traditional buildings</li> <li>▶ Vertical emphasis</li> </ul>	<ul style="list-style-type: none"> <li>▶ Suitable shading devices should be used where possible to suit</li> </ul>	<ul style="list-style-type: none"> <li>▶ Appropriate acoustic treatment with respect to construction materials and openings in buildings shall be determined in accordance with Australian Standards AS 2107 and AS 3671.</li> </ul>

<b>Miscellaneous</b>	<ul style="list-style-type: none"> <li>▶ Colours: heritage colours or suitable variations are preferred</li> <li>▶ Advertising signs on mixed use buildings fronting Oxford Street and other commercial buildings</li> </ul>	<ul style="list-style-type: none"> <li>▶ Future structures are to be designed and sited in such a way that they will not detract from the heritage significance of Paddington, the site, or any buildings or structures to be retained</li> <li>▶ Advertising signs on mixed use buildings fronting Oxford Street and other commercial buildings             <ul style="list-style-type: none"> <li>– location, size and nature of all advertising signs is to conform with Council's advertising code</li> </ul> </li> </ul>	<ul style="list-style-type: none"> <li>▶ Secondhand brick paving and recycled stone should be considered for landscaping</li> <li>▶ Use of deciduous trees in appropriate locations to provide summer shelter and winter sun</li> </ul>	<ul style="list-style-type: none"> <li>▶ A minimum of two hours solar access to windows of habitable rooms should be achieved between 9am and 3pm on 21 June</li> </ul>
----------------------	--	---	---	---

## G7.7 Landscape management plan

This landscape management plan outlines how the existing landscape is to be managed when the site is redeveloped.

1. Cluster of existing trees to be retained, including:
  - ▶ *Cinnamomum camphora*;
  - ▶ *Cedrus deodora*;
  - ▶ *Ficus* sp.;
  - ▶ *Bauhinia* sp. and
  - ▶ *Eucalyptus* sp.
2. Cluster of Camphor Laurels to be retained. Long term replanting will need to be undertaken.
3. Canary Island Date Palm to be transplanted.
4. Bangalow Palm to be transplanted.
5. Butia Palm to be transplanted.
6. London Plane Tree to be retained.



Chapter G8  
252-254 New South Head Road,  
Double Bay

Part G ► Site-Specific Controls

CHAPTER G8 APPROVED ON 9 OCTOBER 2023  
AND COMMENCED ON 27 OCTOBER 2023



# Chapter G8 ▶ 252-254 New South Head Road, Double Bay

## Contents

- G8.1 INTRODUCTION..... 1**
  - G8.1.1 Background..... 1
  - G8.1.2 Land where this chapter applies ..... 1
  - G8.1.3 Development to which this chapter applies..... 2
  - G8.1.4 Objectives..... 2
  - G8.1.5 Relationship to other parts of the DCP ..... 2
- G8.2 DEVELOPMENT CONTROLS..... 3**
  - G8.2.1 Desired future character ..... 3
  - G8.2.2 Built form and façade articulation ..... 3
  - G8.2.3 Environmental impacts..... 6
  - G8.2.4 Apartment mix ..... 6
  - G8.2.5 Deep soil landscaped area..... 7
  - G8.2.6 Vehicular access ..... 8
  - G8.2.7 Car parking..... 8
  - G8.2.8 Site facilities..... 9





## G8.1 Introduction

### G8.1.1 Background

Land at 252-254 New South Head Road, Double Bay, is zoned R3 Medium Density Residential under the Woollahra Local Environmental Plan 2014 (Woollahra LEP 2014). The site is approximately 100m from the Edgecliff Commercial Centre and about 200m from the Double Bay Centre. The site is immediately surrounded by residential flat buildings of heights varying between three to seven storeys. A visually prominent Jacaranda tree is located on the south-east corner of the site adjacent to the New South Head Road frontage.

The site was subject to a planning proposal that increased the height of buildings standard to 22m and the floor space ratio standard to 2.6:1. Woollahra Local Environmental Plan 2014 (Amendment No. 30) also introduced Clause 4.3C that allows an exception to the height of buildings standard and provides a secondary height of buildings standard of RL45.90m. Clause 6.8 also requires a site-specific DCP to be prepared before any consent is granted on the site.

A secondary height of buildings standard of not more than RL 45.90m applies if the building is within 11m of –

- (a) The southern boundary of the land, adjoining the driveway of SP 4585, 248-250 New South Head Road, or
- (b) The south-eastern boundary of the land, adjoining New South Head Road.

This chapter includes additional provisions to address adverse environmental and other amenity impacts that could result from development benefitting from the greater height and floor space permitted.

### G8.1.2 Land where this chapter applies

This site specific chapter applies to the land identified on the map at Figure 1 (the site). The land comprises 252-254 New South Head Road, being legally described as SP 11702.

**FIGURE 1 The site**



---

### G8.1.3 Development to which this chapter applies

---

This chapter applies to development requiring consent under the Woollahra Local Environmental Plan 2014.

### G8.1.4 Objectives

---

The objectives of this chapter are to ensure that development on the site:

- O1 Reflects the desired future character for the site and its neighbourhood.
- O2 Has a scale, bulk and design that is compatible with nearby development and the streetscape, particularly in terms of the number of storeys and distribution of height.
- O3 Promotes environmental amenity on the site and surrounding properties
- O4 Does not unreasonably compromise the amenity of nearby residences having particular regard to overshadowing, visual and acoustic privacy, and view sharing.
- O5 Minimises traffic and parking impacts on New South Head Road and surrounding streets.
- O6 Provides a diversity of dwelling sizes.
- O7 Supports the retention of tree canopy and the planting of vegetation screening.

### G8.1.5 Relationship to other parts of the DCP

---

This chapter is to be read in conjunction with other relevant parts of the DCP, including:

- ▶ Part B: Chapter B1.1.3 Double Bay Precinct;
- ▶ Part B: Chapter B3 General Development Controls; and
- ▶ Part E: General Controls for All Development - this part contains chapters on Parking and Access, Stormwater and Flood Risk Management, Tree Management, Contaminated Land, Waste Management, Sustainability, Signage and Adaptable Housing.

In the event of any inconsistency between this site specific chapter and the other chapters, this chapter prevails.

---

## G8.2 Development Controls

### G8.2.1 Desired future character

---

#### Objectives

- O1 To facilitate a built form that is consistent with the desired future character of the site and surrounding area.

#### Controls

- C1 Development on the site must align with the following:
- A building of no more than eight storeys;
  - A street wall height that is part four/part five storeys at the New South Head frontage;
  - Compatibility with the streetscape, in terms of height transition and tree canopy coverage;
  - A diverse range of apartment sizes;
  - Articulated facades that contribute to the visual interest of the building and the character of the local area;
  - A pedestrian entry **from** the New South Head Road frontage; and
  - No more than one vehicle crossover off New South Head Road.

Note: The desired future character for the Double Bay residential neighbourhood is described in Chapter B1.1.3 of the Woollahra DCP 2014.

### G8.2.2 Built form and façade articulation

---

#### Objectives

- O1 To ensure the built form is compatible in height, bulk and design with the site, adjoining development and the streetscape.
- O2 To encourage variation in building height and setbacks to reduce the apparent bulk of any building.
- O3 To ensure a transition downwards in building height as the landform slopes from Ocean Avenue towards Double Bay.
- O4 To ensure built form has an address to the street, provides activation and surveillance, and enhances pedestrian safety.

## Controls

- C1 Any building on the site must be no higher than eight storeys at its maximum, and no more than five storeys above the level of the New South Head Road frontage (refer to Figure 2).
- C2 Notwithstanding C1, the building height on the New South Head Road elevation must be varied so that it presents a maximum of four storeys adjacent to 256 New South Head Road.
- C3 The building height must be articulated across the development to break down visual bulk and respond to site topography.
- C4 Any building must be setback from site boundaries by the minimum amount shown in Figures 3A and 3B.

Note: Storey is defined in the Woollahra DCP 2015 as below:

*storey means a space within a building that is situated between one floor level and the floor level next above, or if there is no floor above, the ceiling or roof above, but does not include—*

- (a) a space that contains only a lift shaft, stairway or meter room, or*
- (b) a mezzanine, or*
- (c) an attic.*

Additionally, the total number of storeys is to be measured using a section view across the site (i.e. not the number visible from a given frontage like New South Head Road).

**FIGURE 2 Secondary height control area (Clause 4.3C of the Woollahra LEP 2014)**

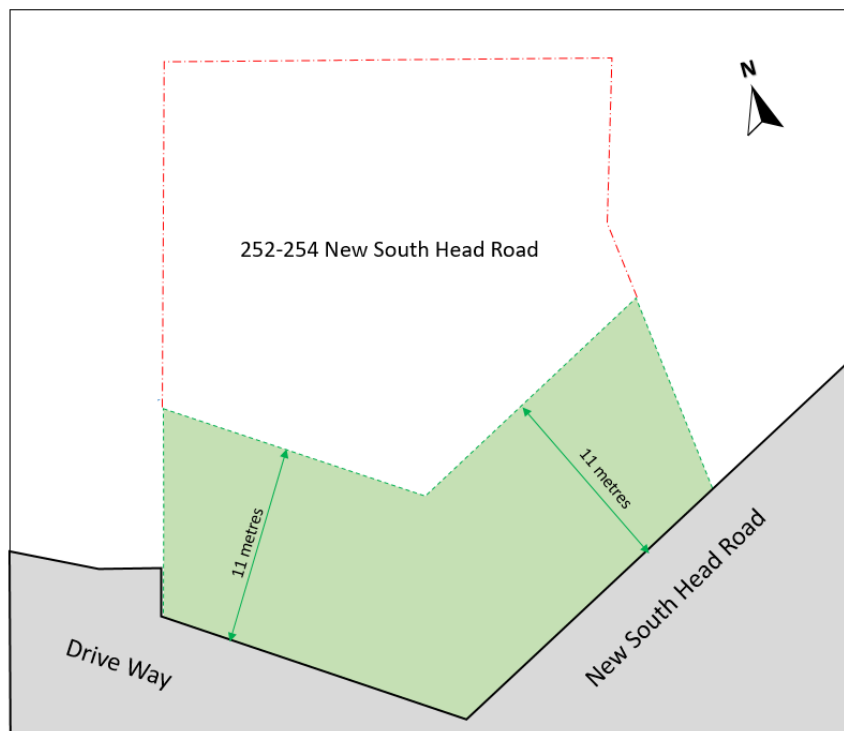


FIGURE 3A Minimum setbacks - storeys ground to four

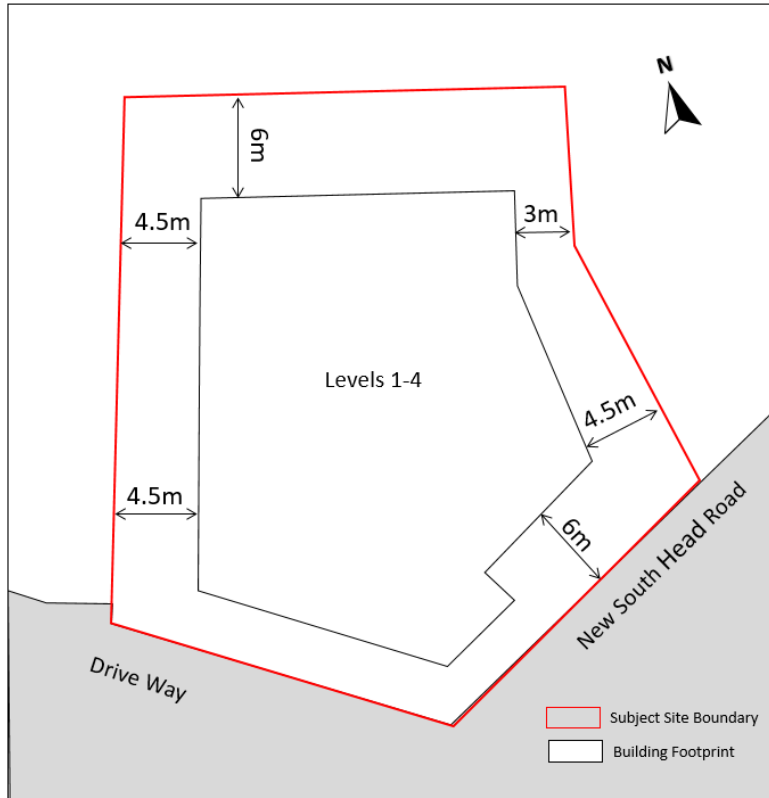
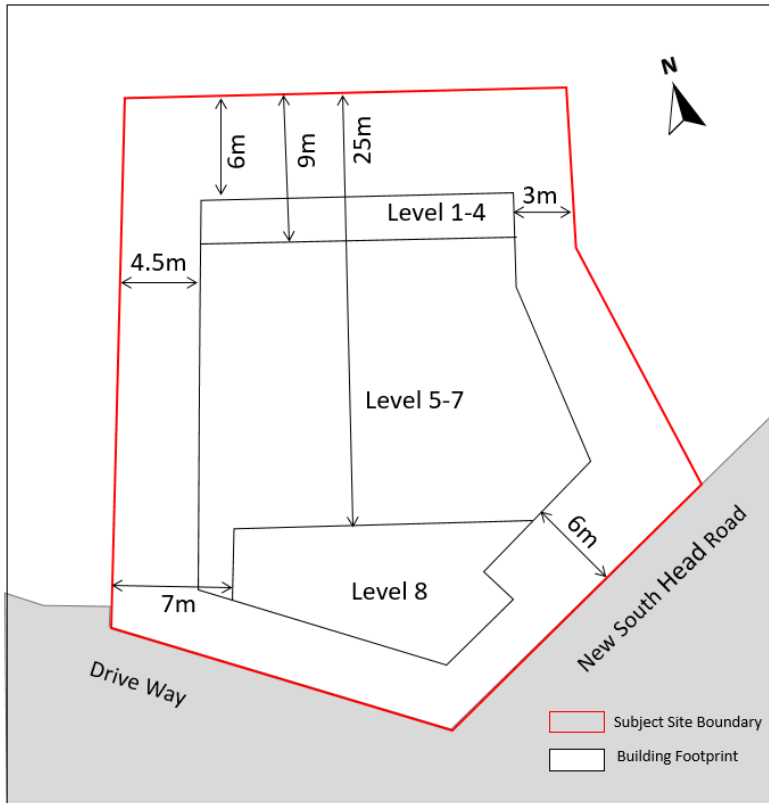


FIGURE 3B Minimum setbacks - storeys five to eight



---

### G8.2.3 Environmental impacts

---

#### Objectives

- 01 To protect the amenity of nearby dwellings, having particular regard to visual and acoustic privacy.
- 02 To minimise overshadowing resulting from development on the site.
- 03 To minimise wind impacts on pedestrians in the public domain and occupants of the site and surrounding properties.

#### Controls

- C1 Balconies, terraces and windows of habitable rooms must not face the side setbacks or towards the driveway of 248 - 250 New South Head Road.
- C2 Balconies, terraces and windows of habitable rooms must be located only on north elevations or the elevation facing New South Head Road, and are to have solid screening walls for the full height and width.
- C3 An Environmental Wind Assessment must be provided to demonstrate acceptable pedestrian level wind conditions on and around the site. The assessment is to be prepared by a suitably qualified wind engineer, and include modelling of the detailed design and appropriate ameliorations for negative effects from impacts such as high pressure on entry doors and potential for internal flow issues, high winds on roof terraces and balconies, Helmholtz resonance, and local wind conditions for stationary activities.
- C4 Any development must minimise overshadowing to habitable rooms and private open space serving dwellings on the site and in surrounding properties, consistent with requirements of the Apartment Design Guide.
- C5 Any building must be designed to reasonably preserve view sharing corridors, consistent with the principles in *Tenacity Consulting v Warringah Council* [2004] NSWLEC 140.

---

### G8.2.4 Apartment mix

---

#### Objectives

- 01 To encourage a range of dwelling sizes within residential development on the site.
- 02 To provide a mix of dwellings to cater for the needs of the existing and future resident population, and to encourage a diverse population.

#### Controls

- C1 Any development on the site is to achieve the apartment mix outlined in Table 1:

**Table 1 Apartment Mix**

Apartment Type	Maximum
Studio	20%
1 Bed	30%
2 Bed	50%
3 Bed or more	10%

Note: The above maximums may be varied on a merit basis if affordable housing is being provided on the site.

### G8.2.5 Deep soil landscaped area

---

#### Objectives

- O1 To provide deep soil landscaped area to support existing trees and substantial new plantings, enhance residential amenity, provide communal open space and reinforce streetscape character.
- O2 To ensure the long-term health of the existing Jacaranda tree and existing palms.
- O3 To enable screen planting for visual privacy along the side and rear boundaries.

#### Controls

- C1 A minimum of 25% of the site area must comprise deep soil landscaping, with minimum dimensions of 3m in any direction and no overhang from any building.
- C2 The existing Jacaranda tree adjoining the south-east boundary with New South Head Road must be retained and protected in accordance with *AS4970 'Protection of trees on development sites'*, with adequate deep soil to ensure its long term health.
- C3 Screen planting must be provided along the full extent of the rear boundary, and where possible along the side boundaries.
- C4 Any proposed works must be located outside of the drip line of trees on adjoining properties, which are to be protected in accordance with *AS4970 'Protection of trees on development sites'*.
- C5 An Arboricultural Impact Assessment must be provided with any development application. It must be prepared by a qualified Level 5 Consulting Arborist and in line with *AS4970 'Protection of trees on development sites'*, Woollahra Municipal Council DA guide and industry best practice. The assessment must clearly indicate trees to be retained and to be removed, and include recommendations and methodologies to mitigate any impact on trees to be retained and a Tree Protection Plan and Specification.

---

## G8.2.6 Vehicular access

---

### Objectives

- O1 To address potential road safety issues that could occur due to landform and proximity of the main intersection at Ocean Avenue.
- O2 To ensure safe vehicular access and minimise potential conflict with eastbound traffic on New South Head Road.

### Controls

- C1 Any vehicular traffic must move using a left in/left out (LILO) motion only.
- C2 Driveway design must ensure access/egress to and from the site uses the kerbside lane only, with no encroachment into the second lane from the kerb.
- C3 A Traffic and Parking Report is to be provided with any application to redevelop the site. It must provide sufficient detail to justify any new vehicular crossover to New South Head Road, and in doing so must demonstrate that other options have been explored. It also must address the safety risk concerning the site's proximity to the crest of New South Head Road at Ocean Avenue.

---

## G8.2.7 Car parking

---

### Objectives

- O1 To minimise car parking due to site constraints and its location close to public transport.

### Controls

- C1 A minimum of six car parking spaces must be provided on the site, with two of these being dedicated car share spaces.
- C2 Prior to lodging a development application, the applicant must negotiate a car share agreement for the dedicated car share spaces. The applicant must include a letter from a commercial car share operator confirming their intention to place the car share vehicles within the development.
- C3 Nominated commercial car share spaces must be placed in publicly accessible locations within the development.



---

## G 8.2. 8 Site facilities

---

### Objectives

- O1 To ensure that essential infrastructure and other site facilities are addressed at the DA stage so that these facilities are accessible and functional, but do not detract from the streetscape character, adversely impact upon the amenity of adjoining residential dwellings, reduce the required deep soil landscaped area at the New South Head Road frontage, or threaten the long term health of the existing Jacaranda tree within the site.
- O2 To ensure any required substation is not visible from the street.

### Controls

- C1 A chamber substation must be provided instead of a kiosk substation.
- C2 Any screening or enclosure to conceal the substation is to be visually unobtrusive, particularly having regard to the location, materials/treatment, height and size of the substation and its enclosure.
- C3 The substation should be installed outside of the mature growth root zone of any trees to be retained, or proposed to be planted, to prevent roots tangling and damaging underground cables to the substation.

### Notes:

- A kiosk substation is a totally enclosed, free-standing, self-contained substation not designed for bodily entry and which is generally operated from door openings.
- A chamber substation is a chamber which is dry and completely isolated from the remainder of the building with walls, floor, ceiling and doors that meets minimum fire resistance levels. Chamber substations make take the form of surface chamber substations, elevated chamber substations, upper-level chamber substations and basement chamber substations.
- At the DA stage the applicant should demonstrate that they have engaged with Ausgrid and have a network capacity assessment undertaken for their proposed development.
- Where a substation is required, the substation should be identified on the DA plans and addressed in the SEPP 65 Design Verification Statement (also see Apartment Design Guide Objective 3C-2 *Amenity of the public domain is retained and enhanced*).
- The DCP requirements for substations apply in addition to the Ausgrid Network Standards.
- The substation is to be identified on the DA plans. The need to modify an existing consent to install a substation should be avoided, and is an approach not supported by Council. Section 4.55 modification applications for substations will need to demonstrate compliance with the DCP including requirements for setbacks, deep soil landscaped area, and tree retention.
- A dedicated access way/easement through the site to the substation may need to be provided in accordance with the requirements of the energy authority and Council.