

## Part C ► Heritage Conservation Areas

WOOLLAHRA DEVELOPMENT CONTROL PLAN 2015



# Chapter C1 Paddington Heritage Conservation Area

Part C ► Heritage Conservation Areas

CHAPTER C1 APPROVED ON 27 APRIL 2015  
AND COMMENCED ON 23 MAY 2015

Last amended on 31 May 2024



# Chapter C1 ► Paddington HCA

## Contents

<b>C1.1</b>	<b>INTRODUCTION .....</b>	<b>1</b>
	C1.1.1 Background.....	1
	C1.1.2 Land where this chapter applies .....	2
	C1.1.3 Development to which this chapter applies.....	3
	C1.1.4 Objectives .....	3
	C1.1.5 Relationship to other parts of the DCP.....	3
	C1.1.6 Definitions.....	4
	C1.1.7 How to use this chapter.....	5
<b>C1.2</b>	<b>UNDERSTANDING THE CONTEXT .....</b>	<b>7</b>
	C1.2.1 The significance of the Paddington Heritage Conservation Area .....	7
	C1.2.2 Building types in Paddington.....	8
	C1.2.3 Character elements.....	8
	C1.2.4 Desired future character .....	11
	C1.2.5 Contemporary design in Paddington .....	12
<b>C1.3</b>	<b>BUILDING TYPES .....</b>	<b>13</b>
	C1.3.1 Single storey buildings .....	14
	C1.3.2 Timber buildings .....	22
	C1.3.3 Corner buildings .....	24
	C1.3.4 Multi-storey terrace style housing .....	26
	C1.3.5 Dwelling houses .....	27
	C1.3.6 Residential flat buildings, manor houses, multi dwelling housing and multi dwelling housing (terraces).....	28
	C1.3.7 Buildings in the William Street MU1 Mixed Use Zone .....	32
	C1.3.8 Commercial and industrial buildings including shops.....	34
	C1.3.9 Pubs .....	41
	C1.3.10 Places of public worship and educational establishments .....	44
	C1.3.11 Public buildings .....	45
	C1.3.12 Existing contemporary infill .....	46
	C1.3.13 Infill development (new development).....	47
	C1.3.14 Intrusive buildings .....	55
<b>C1.4</b>	<b>GENERAL CONTROLS FOR ALL DEVELOPMENT .....</b>	<b>56</b>
	C1.4.1 Principal building form and street front zone of contributory buildings.....	57
	C1.4.2 Side elevations and side additions .....	62
	C1.4.3 Rear elevations, rear additions, significant outbuildings and yards .....	67
	C1.4.4 Roofs and roof forms .....	71
	C1.4.5 Building height, bulk, form and scale .....	73
	C1.4.6 Site coverage, setbacks and levels.....	75
	C1.4.7 Excavation.....	77
	C1.4.8 Private open space, swimming pools, courtyards and landscaping .....	82
	C1.4.9 Views .....	87
	C1.4.10 Acoustic and visual privacy .....	88

---

C1.4.11 Land subdivision and site amalgamations .....	90
<b>C1.5 SPECIFIC POLICY FOR BUILDING AND SITE ELEMENTS .....</b>	<b>91</b>
C1.5.1 Dormers and skylights .....	92
C1.5.2 Chimneys .....	96
C1.5.3 Windows, doors, shutters and security.....	98
C1.5.4 Verandahs and balconies .....	101
C1.5.5 Fences, walls and gates.....	104
C1.5.6 On-site vehicle parking, garages, carports, driveway access and servicing facilities 109	
C1.5.7 Lofts over garages and studios.....	117
C1.5.8 Materials, finishes and details .....	119
C1.5.9 Exterior colours .....	126
C1.5.10 Gardens and trees .....	128
C1.5.11 Satellite dishes, aerials, air conditioning units and other site facilities.....	129
<b>C1.6 PUBLIC DOMAIN .....</b>	<b>132</b>
C1.6.1 Kerbs and gutters .....	132
C1.6.2 Views and vistas .....	134
C1.6.3 Public art .....	133
<b>APPENDIX 1: ORIENTATION OF LOTS IN THE PADDINGTON HCA .....</b>	<b>134</b>

## C1.1 Introduction

### C1.1.1 Background

---

Paddington is a unique urban area of outstanding national heritage significance and the conservation of Paddington and its heritage significance should be the foremost outcome of development.

The special character of Paddington is derived from its historical development and associations. This unique character is also evident in its interrelationship of buildings, spaces, topography, landscape settings and land uses. Paddington's sense of place and its significance results from a multi-layered interrelation of various built forms and spaces and historical and social values.

Paddington needs to be understood as a whole precinct. Some of the individual buildings and sites within the precinct are heritage items, however all other buildings (except for intrusive buildings) are contributory buildings as they make a positive contribution to the character of the area. For Paddington, the whole is greater than the sum of its parts.

Paddington is a living place which will continue to undergo change; appropriate contemporary design is encouraged and necessary if change is to occur in a manner which respects the significant characteristics of Paddington.

#### Conservation philosophy

The controls for the Paddington Heritage Conservation Area (HCA) contained in this chapter are based on the Paddington Heritage Conservation Area DCP 2008. The Paddington Heritage Conservation Area DCP 2008 was the culmination of a review of the Paddington DCP 1999. The review of the Paddington DCP 1999 included input from a working party comprising representatives from The Paddington Society, the National Trust of Australia (NSW), the Woollahra History and Heritage Society, the NSW Heritage Office and Woollahra Councillors.

This chapter of the DCP adopts the conservation philosophy embodied in the Australia ICOMOS Charter for the Conservation of Places of Cultural Significance (the Burra Charter).

The Burra Charter is widely accepted by Government agencies at all levels and by private industry as the standard philosophy for heritage conservation practice in Australia. The Charter sets down principles, processes and practices for the conservation of significant places. Certain terms used in the Burra Charter are also used in this chapter and are defined in Section C1.1.6.

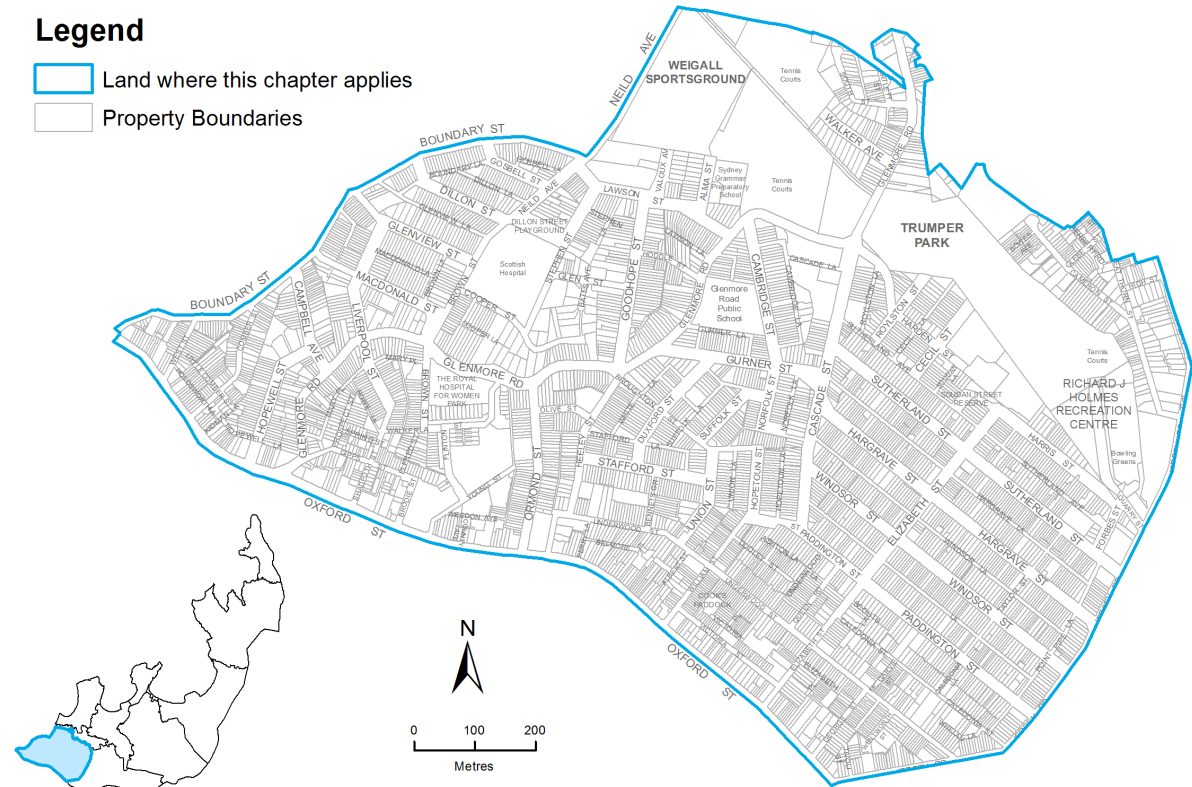
Note: The term 'original' as used throughout the DCP refers to any significant fabric. This may be from a range of historic periods.

### C1.1.2 Land where this chapter applies

This chapter applies to the Paddington HCA as identified in Map 1.

Parts of the suburbs of Edgecliff and Woollahra are located in the Paddington HCA; this chapter applies to those parts.

MAP 1 Paddington Heritage Conservation Area boundary map





---

### C1.1.3 Development to which this chapter applies

---

This chapter applies to development that requires consent under Woollahra Local Environmental Plan 2014 (Woollahra LEP 2014).

Generally this will be residential or commercial development, but may include other permitted uses such as child care centres, community facilities, educational establishments and places of public worship.

### C1.1.4 Objectives

---

The objectives of this chapter are:

- O1 To facilitate the implementation of the objectives and provisions relating to heritage conservation contained in Woollahra LEP 2014.
- O2 To acknowledge and conserve the unique National heritage significance of Paddington.
- O3 To conserve the significant types of buildings within the Paddington Heritage Conservation Area.
- O4 To provide guidelines and controls which seek to protect the significant character of Paddington and which encourage contemporary design which responds appropriately to that character.
- O5 To encourage and promote public awareness, appreciation and knowledge of heritage conservation.
- O6 To enhance amenity and heritage values within Paddington.
- O7 To ensure that development is consistent with the heritage significance of the Paddington Heritage Conservation Area.

### C1.1.5 Relationship to other parts of the DCP

---

This chapter is to be read in conjunction with the other parts of the DCP that are relevant to the development proposal, including:

- ▶ Part B: Chapter B3 General Development Controls, but only if the proposal is for a dual occupancy development (refer to Section B3.8 Additional controls for development other than dwelling houses).
- ▶ Part E: General Controls for All Development - this part contains chapters on Parking and Access, Stormwater and Flood Risk Management, Tree Management, Contaminated Land, Waste Management, Sustainability, Signage and Adaptable Housing.
- ▶ Part F: Land Use Specific Controls - this part contains chapters on Child Care Centres, Educational Establishments, Licensed Premises and Telecommunications.

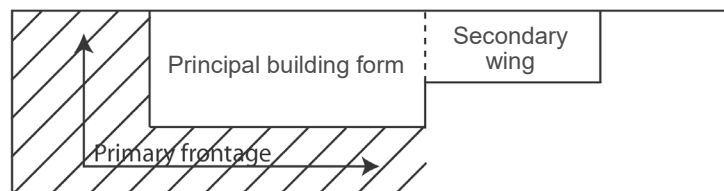
## C1.1.6 Definitions

---

The definitions below define words and expressions for the purpose of this chapter.

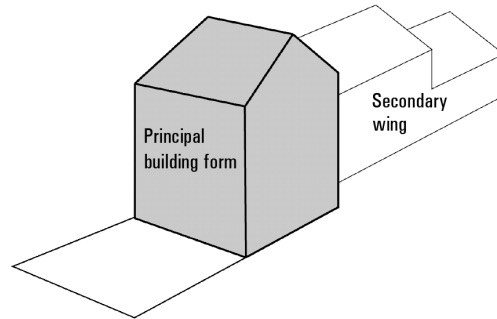
These definitions apply in addition to the definitions in Part A Chapter A3 of the DCP, the Environmental Planning and Assessment Act and Woollahra LEP 2014.

<b>ancillary development</b>	a building or structure, other than a dwelling house, dual occupancy, semi-detached dwelling, mixed development, attached housing, multi-dwelling housing, residential flat building, manor housing, multi dwelling housing (terraces) or other housing type, but including sheds, pool houses, detached garages, gazebos, separate laundries, pagodas, swimming pools and pergolas.
<b>balconet</b>	is an area incorporating a guard rail only and a very minor projection from the outer wall of a building, fronting windows with deep sashes or inward opening doors, preventing people from falling.
<b>breezeway</b>	an unenclosed passage or void between the side boundary and rear wing.
<b>missing elements</b>	based on known evidence, including where the missing elements exist to related properties rather than speculation).
<b>primary frontage (corner lots)</b>	that part of the site in the street front zone and the part between the side street and the principal building form (see diagram).



**principal building form**

the original front building section and main roof, which contains the main rooms (see diagram).



### C1.1.7 How to use this chapter

The provisions of this chapter are to be used by applicants in the sequence set out below.

**TABLE 1** How to use this chapter

Steps to be considered for all development	
<b>Step 1</b>	<p><b>Understanding the context</b></p> <ul style="list-style-type: none"> <li>▶ Read the statement of significance for the Paddington HCA in Section 1.2.1.</li> <li>▶ Read the desired future character statement for the Paddington HCA in Section 1.2.4.</li> <li>▶ Development is to achieve the outcomes expressed in the desired future character statement. Applications will be assessed against their ability to satisfy those outcomes relevant to the proposal, amongst other matters.</li> </ul>
<b>Step 2</b>	<p><b>Investigating heritage significance</b></p> <ul style="list-style-type: none"> <li>▶ Identify whether the subject building or site is a heritage item as identified in Woollahra LEP 2014.</li> <li>▶ All other buildings within the Paddington HCA are ‘contributory buildings’ as they make a positive contribution to the character of the area. The only exception to this is for ‘intrusive buildings’ which are inappropriate to the character of Paddington in regard to scale, proportions, materials and design.</li> <li>▶ Consider the history and relationship of the subject site and surrounding sites, having particular regard to the building type/s to which the development applies. The history and relationships are to be conserved.</li> <li>▶ Identify the key building fabric relevant to the building type and the site. Original key fabric is to be conserved.</li> </ul>

**Step 3 Addressing the objectives and controls**

For all development, each section must be read and the relevant controls applied:

- ▶ Section C1.3 Building types: There are 14 building types, each with specific objectives and controls. Note, more than one building type may apply to your development.
- ▶ Section C1.4 General controls for all development. This section applies to all development including existing buildings and infill development.
- ▶ Section C1.5 Specific policy for building and site elements: Specific controls for building and site elements on residential and non-residential buildings.
- ▶ Section C1.6 Public domain: Applies to land owned and/or managed by Council or other public authorities.

## C1.2 Understanding the context

### C1.2.1 The significance of the Paddington Heritage Conservation Area

Paddington is a unique urban area which possesses historical, aesthetic, technical and social significance at a National and State level. An important factor in the significance of Paddington is its exceptional unity, encompassing scale, character, history, architecture and urban form.

The built environment of Paddington is an excellent example of the process of 19th century inner city urbanisation of Sydney which was largely completed by 1890. The predominant Victorian built form is an excellent representative example of the phenomena of land speculation and a 'boom' building period between 1870 and 1895.

The terraces of Paddington clearly trace the evolution of the imported English Georgian and Regency terrace models into the distinct Australian style evident in the Victorian era terraces.

Paddington retains many significant types of buildings that represent all phases of the suburb's historical development. These building types range from modest, small-scale, single storey timber and masonry cottages, to remnant examples of former gentry mansions, boom style middle-class terrace houses, apartment blocks and contemporary infill development, all of which are set in a varied network of streets, lanes and pedestrian accessways which reflect the phases of subdivision and development.

Paddington has a multitude of important historical and social associations. It is linked with the early transport routes along South Head Road (Oxford Street) and Point Piper Road (Jersey Road), the construction of Victoria Barracks in the 1840s, the gentry estates, prominent figures of the early colony, the speculative building boom between 1870 and 1890, and the development of Australian tennis at the White City site. Its historical and social associations extend to the periods of occupancy by immigrant groups and minority groups including the Chinese market gardeners, the Jewish community around the turn of the century, the European immigrants in the 1950s and an alternative artistic and intellectual population in the 1960s and 1970s. Today Paddington has a high level of social esteem and is regarded as one of Sydney's most desirable inner-city urban areas. The changing sociology of Paddington demonstrates phenomenal variations in status and changes in community attitudes to the 19th century suburb.

Paddington has important associations with the evolution of the conservation movement in Australia, in particular with the actions by the National Trust and the Paddington Society, which ensured its conservation at a time of redevelopment threat in the 1960s. It is significant as the first suburb classified by the National Trust, a community based, non-government organisation committed to promoting and conserving Australia's heritage.

Paddington has a unique aesthetic significance due to the superimposition of the built form on a sloping topography which overlooks Sydney Harbour and its foreshores. The coherent and extensive Victorian built form comprising groups of terrace buildings on narrow allotments which step down hills, turn corners or sit in ranks along tree lined streets produces a singularly recognisable image.

Inter-War flat buildings are also present in Paddington, ranging from around 1918 to circa 1950. Many of these buildings make an important historic, aesthetic, social and representative

---

contribution to the character and illustrate the historical evolution of development of the area. They demonstrate the key characteristics of architectural styles of the Inter-War period.

Paddington provides vast opportunity for research, education and interpretation through the physical layout of its road network, its subdivision pattern and the varied form of buildings.

These buildings provide an excellent record of past technologies and domestic lifestyles through features such as original external and internal building fabric, detailing and room layouts. Terrace houses, semi-detached dwellings, flat buildings and freestanding houses all show the evolving attitudes towards families and the home from the early 19th to the late 20th century.

### C1.2.2 Building types in Paddington

---

The built environment of Paddington reveals the historic development of the area. Building types and styles exemplify stages of development and support the overall cultural significance of the area.

Examples of the 1840 to 1870 phase of development include small workers' cottages and boldfaced terraces from the original Paddington village, and grand mansions from the large gentry estates built along the ridgelines, such as Juniper Hall. Rows of Victorian boom style terraces were built between 1870 and 1910 on the subdivisions of the early land grants and large estates.

Later development which occurred on further subdivisions, vacant blocks, or on redeveloped sites includes Federation era terraces, Inter-War flat buildings, 1960s and 1970s high rise style units, and more recently some excellent examples of contemporary infill.

The building types most commonly found in Paddington include multi-storey and single-storey terrace house rows, single-storey timber and masonry houses, freestanding houses, mixed commercial and residential buildings, commercial and industrial buildings, pubs and contemporary infill buildings. To ensure that development proposals recognise and respect the particular characteristics of particular building types, Section C1.3 of this chapter sets out specific objectives and controls for these and other building types.

### C1.2.3 Character elements

---

The character elements represent the distinguishing features of the area that are to be retained. Applications to change the character elements will be assessed against the desired future character controls.

#### Introduction

Paddington has a valuable historic and predominantly 19th century residential character, which is represented by late-Victorian terrace houses, modest workers' cottages, including single-storey timber and masonry houses, and former mansions. It also contains a mix of shops and pubs, residential flat buildings, commercial buildings and a few surviving light industrial and warehouse buildings, with many being adapted to residential uses.

---

---

To protect the heritage significance of Paddington it is important to retain and conserve the many building types that represent the significant phases of the suburb's historical development. These are important buildings and many have original outbuildings, fences and garden settings that are important elements to preserve.

Other townscape features such as significant trees and historical sandstone kerbs and gutters also contribute to the significance of the Paddington HCA.

It is particularly important to conserve the significant fabric and layout of the original front building section which contains the main rooms. This section, including its roof, is referred to as the "principal building form", and commonly faces the street front, with a secondary section behind. The main rooms often contain the most significant details such as plaster work, timber joinery and fireplace surrounds.

Many terrace houses have a small setback from the street. This area, referred to as the "street front zone", provides an important setting for buildings. The setting for freestanding buildings, including timber cottages, is established with their front, side and rear setbacks.

Additions and alterations to existing buildings and the construction of new buildings should be designed with respect to the architectural character of the building and the context of the significant streetscapes of the Paddington HCA. Retention of original fabric and detail is key.

Reconstruction and reinstatement of missing details and building elements is important and encouraged. This includes the removal of inappropriate building elements.

Even small changes to buildings in Paddington require careful consideration. This is critical when changes are visible from the street or from other public spaces.

Alterations to the rear of properties require detailed consideration so as not to alter the proportion, scale and the cohesion in groups of buildings. Due to the topography and the subdivision patterns, rear elevations are often highly visible from the public domain.

In Paddington, the aim should always be to establish a cohesive relationship between new work and the existing building fabric. Contemporary design must respond appropriately to relevant aspects of the historical context.

### Natural and built character elements

The existing distinguishing natural and built character elements of the Paddington HCA include:

- ▶ A topographical form which is shaped into a natural amphitheatre facing north over flatlands and former swamps allowing views to Rushcutters Bay, Sydney Harbour and westwards to the city. This land form also enables internal views of secondary ridges and gullies.
- ▶ A variable and intricate street, lane and pedestrian network. The western side of Paddington, originally the Paddington Village, is characterised by short, angled narrow roads with closed vistas and dogleg junctions influenced by the boundaries of early land grants. Dense rows of cottages and terrace housing often have zero setback.

Later street patterns in the eastern half of Paddington were laid out in the Victorian building boom period. The subdivisions are more strictly ordered with alternating wide streets and rear lanes and are set out on a rectangular grid. Development on corner sites is usually

sensitive to the pivotal position they occupy in both streetscapes. Streets provide long vistas. Road surfaces are asphalt and kerbing and guttering is a mix of sandstone and concrete.

- ▶ A strong pedestrian character which is reflected in the multitude of passageways, rear and side interconnecting lanes, narrow streets and intermix of residential and non-residential uses. Footpath pavement material is a mixture of asphalt, fly ash concrete and modern concrete.
- ▶ A land use character which is predominantly residential but which also contains a mix of shops and pubs (often located on corners), some commercial buildings, and a few remaining light industrial and warehouse style buildings.
- ▶ Evidence of the evolution of building styles which reflect historical patterns of growth and land use.
- ▶ Terrace housing which forms continuous facades along the streets and steps down the hillside.
- ▶ Modest housing forms such as single-storey timber and masonry cottages.
- ▶ Variable building heights between terrace groups, one-off buildings and different building types, including timber and masonry cottages.
- ▶ Terrace housing, predominantly in distinguishable groups, which displays similar character in terms of form but variation in architectural styles, surface decorative details, verandahs and balcony design, window, door, roof forms and chimney treatments.
- ▶ A strong contrast between the formal and frequently more decorative front of the terrace to the street and the simple and utilitarian back of the terrace.
- ▶ A street front which in many terraces is characterised by a cast iron palisade fence returning to form side party fencing, a small front garden and path, recessed verandah on the ground floor and balcony on the upper level enclosed by a cast iron balustrade. Other terraces have only a small setback from the street, no front garden, and a cast iron fence to the verandah. Some terraces are built to the front boundary and have an upper floor balcony which cantilevers the footpath. Many Victorian boom style terraces terminate with a street front parapet.
- ▶ Some laneways which retain culturally significant fabric including paling fencing, pedestrian gates, brick lavatories and backyard planting.
- ▶ A restricted palette of materials including stone, painted stucco, cast iron and tessellated tiles, corrugated roof materials and slate, nearly universal to all street frontages.
- ▶ A perceived homogeneity of a Victorian era terrace built form which on close examination is made up of a diversity of building types reflecting the historical development of Paddington.
- ▶ A variety of open space and landscape features which are represented in:
  - flatland parks and playing fields - Trumper Oval, Weigall Sportsground, White City;
  - escarpment areas - Trumper Park;
  - public open space created by street closures;
  - early municipal street tree plantings;
  - pocket parks often created on gap sites within the terrace streetscape;
  - remnant established gardens from earlier gentry estates such as the former Scottish Hospital grounds;



- 
- private open space within institutions - Sydney Grammar's Weigall Grounds, White City; and
  - private gardens which contribute significantly to the townscape quality of streets and laneways.

### C1.2.4 Desired future character

---

The desired future character is a vision statement about the future image and function of the Paddington HCA. Applications will be assessed, among other matters, against their ability to satisfy those outcomes relevant to the development proposal.

This chapter seeks to achieve a desired future character for the Paddington HCA which:

- a) retains the unique national heritage significance of Paddington and recognises it as a rare and distinctive urban area;
- b) reinforces the area as a special residential precinct;
- c) retains and promotes evidence of the historical development of the area and enables interpretation of that historical development;
- d) retains the cohesive character evident in the low scale, high density built form;
- e) retains distinctive features such as parapets, chimneys, mixture of roofs, complex of roads, laneways and alleyways, consistency of colours, subdivision patterns and buildings which follow the landform and the distinctive patterns of terrace house groups;
- f) continues to cater for varied uses and building types within the residential area;
- g) retains the diversity of building types including multi-storey and single-storey terrace house rows, modest scale timber and masonry cottages, semi-detached dwellings, dwelling houses, commercial buildings, pubs, former industrial buildings, places of public worship, Inter-War flat buildings and public buildings;
- h) enables people to walk or cycle to shops, public transport, schools, parks and entertainment facilities in a safe, pleasant and healthy environment;
- i) provides attractive and vibrant shopping areas for locals and tourists;
- j) provides for sharing of views and vistas; and
- k) exhibits contemporary design excellence.

As Paddington is a living place and will be subject to change over time, Council seeks to encourage new development of a high design standard which respects the significance of the area.

The statement below on contemporary design emphasises the role that modern day design plays in the evolution of Paddington. Issues of contemporary design are relevant to development in the public and private domains.

---

### C1.2.5 Contemporary design in Paddington

---

Contemporary design provides the basis for the continuing enrichment of the historic interpretation of Paddington by adding to our understanding of contemporary life as expressed in the built environment. Issues of contemporary design are relevant to new development of a minor and major nature in the both the public and private domains. Quality architectural design must form the basis of any proposed new works. Contemporary design must be respectful of the HCA.

Paddington is characterised by rows of 19th century buildings. Paddington has a number of significant buildings and building elements that represent the changing character of design from the 19th century-21st century. The presence of buildings and building elements representing the various design elements of the 20th and 21st centuries enrich the character of Paddington and the interpretative aspects of its history.

A range of contemporary design approaches, philosophies and techniques can be employed in Paddington. These are encouraged in appropriate locations and circumstances.

Council does not advocate replication of previous architectural styles in cases of infill development. However, infill development should be based on a contemporary design approach which respects the context, especially the predominant scale, form and articulation of buildings that characterise an area. New contemporary design should respect the historic built form of the Paddington HCA.

Certain types of new work require a traditional design approach. Such an approach may be appropriate where alterations and additions are proposed for those areas of a building which have original significant fabric.

A thorough understanding of the physical and historical aspects of the site and its context will act as a guide to the appropriateness of the design approaches. Applicants must demonstrate that contemporary design techniques, materials or idioms provide an appropriate response to relevant aspects of the physical and historical context. Applications are required to demonstrate that contemporary design techniques, materials and design elements provide an appropriate response to the relevant aspects of the historical and physical context.

The use of contemporary design approaches, particularly to infill development, work to an intrusive building, work to the public domain, and work to buildings or building elements of heritage significance, must achieve a cohesive relationship between new and existing urban fabric, and respect and respond to the context of the HCA.

## C1.3 Building types

To protect the heritage significance of Paddington it is important to retain and conserve the many building types that represent the significant phases of the suburb's historical development.

The applicant is to identify which of the building types listed below are relevant to the proposal, and comply with the objectives and controls for those building types.

Where development involves an existing building, more than one building type control may apply. For example:

- ▶ for single storey dwellings— the building type controls for single storey buildings and dwelling houses apply;
- ▶ for a single storey corner shop— the building type controls for single storey buildings, corner shops and corner commercial buildings, and commercial and industrial buildings apply;
- ▶ for a single storey freestanding dwelling house— the building type controls for single storey buildings and dwelling houses apply.

### Building types

The building types in this section are:

- ▶ 1.3.1 Single storey buildings (applies to residential and non-residential buildings)
- ▶ 1.3.2 Timber buildings
- ▶ 1.3.3 Corner buildings:
  - Corner terrace houses
  - Corner shops and corner commercial buildings
- ▶ 1.3.4 Multi-storey terrace style housing (defined in Woollahra LEP 2014 as either semi-detached dwellings or attached dwellings)
- ▶ 1.3.5 Dwelling houses
- ▶ 1.3.6 Residential flat buildings, manor houses, multi dwelling housing (terraces) and multi dwelling housing
- ▶ 1.3.7 Buildings in the William Street MU1 Mixed Use Zone
- ▶ 1.3.8 Commercial and industrial buildings including shops
  - All commercial buildings
  - Commercial development in Oxford Street
- ▶ 1.3.9 Pubs
- ▶ 1.3.10 Places of public worship and educational establishments
- ▶ 1.3.11 Public buildings
- ▶ 1.3.12 Existing contemporary infill
- ▶ 1.3.13 Infill development (new development)
- ▶ 1.3.14 Intrusive buildings

---

### C1.3.1 Single storey buildings

---

Single storey buildings include timber, stone, brick and weatherboard cottages, terraces, semi-detached houses and single storey shops.

Architectural styles include Georgian, Victorian and Federation. The scale of buildings generally range from the typical small and narrow fronted buildings to medium to large houses ranging in date from 1840s to 1920s.

Single storey buildings, in particular the timber cottages, are significant because of their rarity. Many single storey buildings are also significant because of their historical association with the evolution of the early Paddington village and the artisan community that developed at the junction of Glenmore Road and New South Head Road.

Additions to these single storey buildings need to be carefully considered (see Figure 1). Refer to Figures 2 and 3 for examples of intrusive and non-intrusive extensions.

#### Objectives

- O1 To retain and conserve single storey buildings.
- O2 To conserve the settings of single storey buildings.
- O3 To ensure that the scale and form of single storey buildings are retained and that alterations and additions do not dominate the building.
- O4 To retain and enhance the distinctive shared characteristics of the rear elevations of pairs or groups.

#### General Controls

These controls apply to all alterations and additions to single storey buildings, including courtyard housing additions:

- C1 Principal building forms and original external materials are to be retained.
- C2 Retain or reinstate façade details and open verandahs where physical or documentary evidence exists demonstrating an earlier state.
- C3 Where alterations are required to meet the National Construction Code requirements, materials must be consistent with traditional materials and finishes.
- C4 Additional storeys are not permitted to the principal building form where the existing roof height will be increased, and changes to the existing roof pitch and eaves height will occur.
- C5 Roof space within the principal building form may be used where there will be no change to the existing roof height, roof pitch, eaves height or ceiling below. No change to the rear roof plane is permitted to the principal building form with the exception of a compliant dormer and skylight.

---

Note: Control C5 is included to ensure that the rear roof of the principal building is not raised to incorporate a higher extension or higher link structure to courtyard housing.

- C6 The addition of dormers or skylights in the rear roof slope of the principal building form is to comply with controls in Section 1.5.1 Dormers and skylights.
- C7 Ground floor additions and courtyard housing additions to the rear of a single storey building must not compromise the form of the principal building.
- C8 Existing setbacks from the front and side boundaries for the principal building form are to be retained.
- C9 Additions at the rear of buildings must not extend beyond the predominant rear building setbacks at any level of a group or row of buildings.
- C10 Additions of an appropriate form and scale are permitted at the rear of the principal building form if:
  - a) the addition is a ground floor rear addition attached to the principal building below the existing eave or employs a courtyard housing style addition (refer to controls below); and
  - b) for additions other than courtyard housing additions, the addition incorporates a skillion roof. Reverse skillion roofs are not permitted.
- C11 Additions to single storey semi-detached and terrace groups must not compromise the architectural character of the pair, or the group of houses.

#### *Courtyard housing additions*

Courtyard housing is not an infill development or a garage or a loft over a garage or a studio. Controls for infill development are included in C1.3.13. Controls for a loft over a garage or studio are included in C1.5.7.

- C12 A courtyard housing addition may be permitted if:
    - a) it would not have an adverse impact on the heritage significance of the existing building, adjoining properties, or the group of buildings, where the building forms part of a group;
    - b) it does not disrupt a coherent pattern of pairs or groups;
    - c) it is not visible, directly or obliquely, from any part of the street to which the property's street front zone abuts and from the front yard within the street front zone;
    - d) it will have a negligible impact on the amenity of neighbouring properties in terms of loss of sunlight, ventilation and privacy;
    - e) it will not adversely affect the setting of the existing building; and
    - f) it is subsidiary to the existing building and will not dominate the existing building in terms of bulk and scale.
  - C13 A courtyard housing addition must be single storey and must not be able to be seen over the roof of the principal building.
  - C14 A courtyard housing addition must be wholly located at the rear of the existing principal building. Additions that wrap around the principal building are not appropriate.
-

---

C15 Where a courtyard housing addition is appropriate:

- a) a narrow, non-habitable linking structure may be provided between the principal building form and the courtyard housing addition;
- c) the linking structure must be single storey, with a maximum height of 2.4m or below the eaves of the principal building form, whichever is the lower;
- d) the width of the linking structure must be a maximum of 1.5m internally;
- e) the linking structure must be a narrow, non-habitable lightweight construction to differentiate the new work from the original. Lightweight construction should comprise appropriate materials, roof form and overall design. Appropriate materials include glass, steel and timber. Very minor masonry material may be included;
- f) it must include a usable courtyard, provided that a compliant rear building alignment can be achieved and the bulk and scale of the addition does not result in adverse privacy and overshadowing impacts on adjoining properties;
- g) the inclusion of a courtyard must comply with the controls and minimum requirements in Section C1.4.8 Private open space, swimming pools, courtyards and landscaping; and
- h) the height of the courtyard housing addition must not exceed the ridge height of the principal building form (chimneys not included).

Note: see Figure 3B for reference.

C16 The roof of the courtyard housing addition must:

- a) be an appropriate response to the traditional roof form and pitch of the principal building. Skillion roofs must comprise a single roof plane. Curved roofs, flat roofs, mansard roofs, parapet roofs and reverse skillion roofs are not permitted; and
- b) match the pitch of roofs where an unchanged established pattern of rear roofs exists or, where an unchanged pattern does not exist, must be a minimum pitch of 6 degrees.

C17 Provided that C12 and C15 are satisfied, a contemporary design for the courtyard housing may be used.

C18 An attic is permitted within the roof space of the courtyard housing addition, provided that:

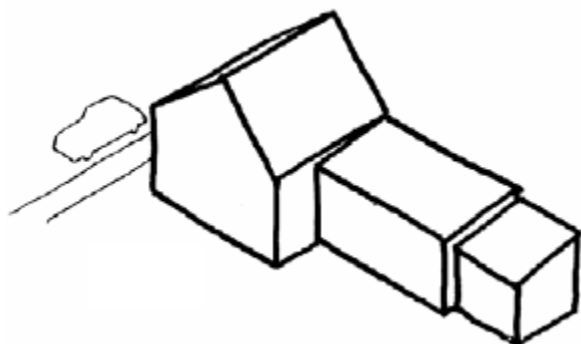
- a) satisfactory floor to ceiling height standards are achieved;
- b) the form and pitch of the courtyard housing addition roof matches the form and pitch of the roof of the principal building;
- c) only one dormer is permitted (in either the front or rear roof plane). Where the width of the addition is greater than 6m, a second dormer may be permitted in the same roof plane, provided that each dormer is identical in type, size and no greater than 1.2m maximum width overall. The top of the dormer must be set below the main ridge by at least 300mm. The inclusion of a dormer must comply with the controls in Section C1.4.10 Acoustic and visual privacy; and
- d) no more than 2 skylights (compliant with the controls for Skylights in C1.5.1 Dormers and Skylights) are located within the entire roof plane.

C19 Roofing materials must comply with C1.5.8.

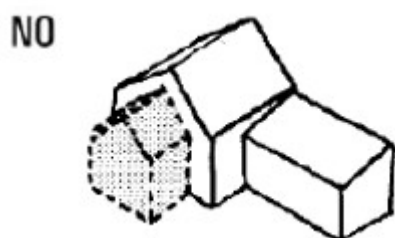
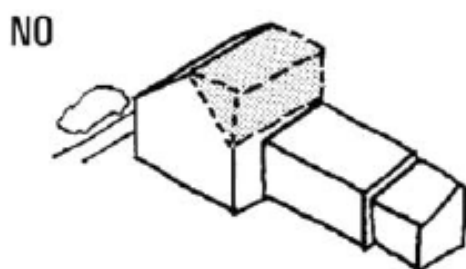
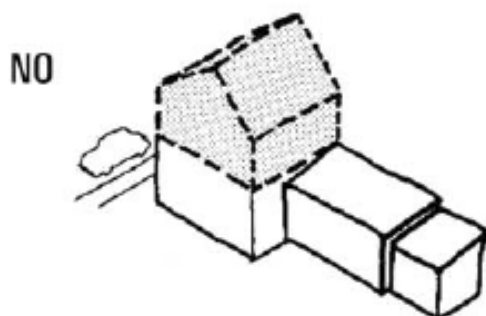
---

Refer to objectives and controls in C1.4 General controls for all development and C1.5 Specific policy for building and site elements.

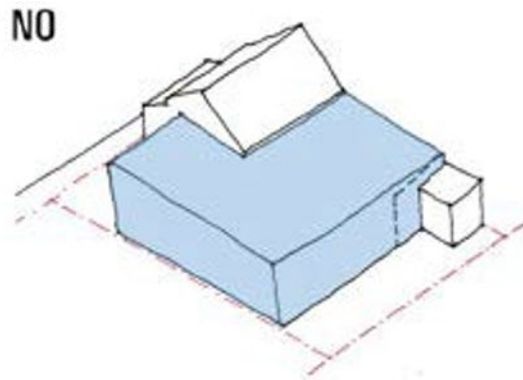
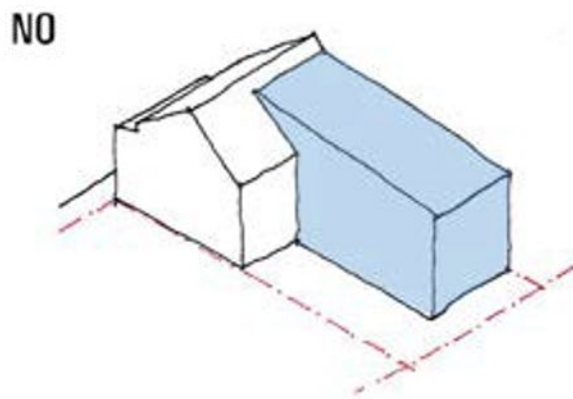
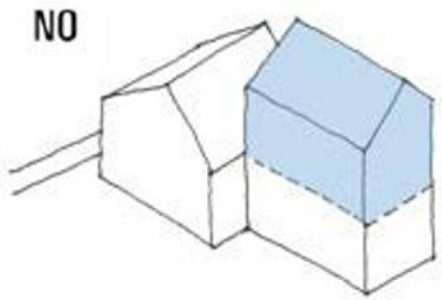
**FIGURE 1** Generic version of a single storey terrace



**FIGURE 2A** Intrusive additions

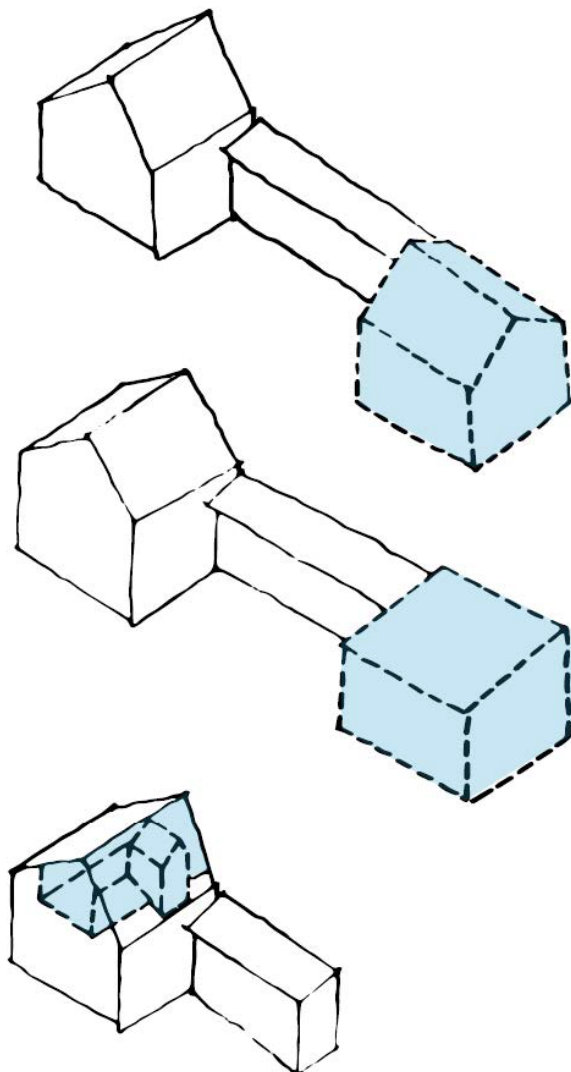


**FIGURE 2B** Intrusive additions

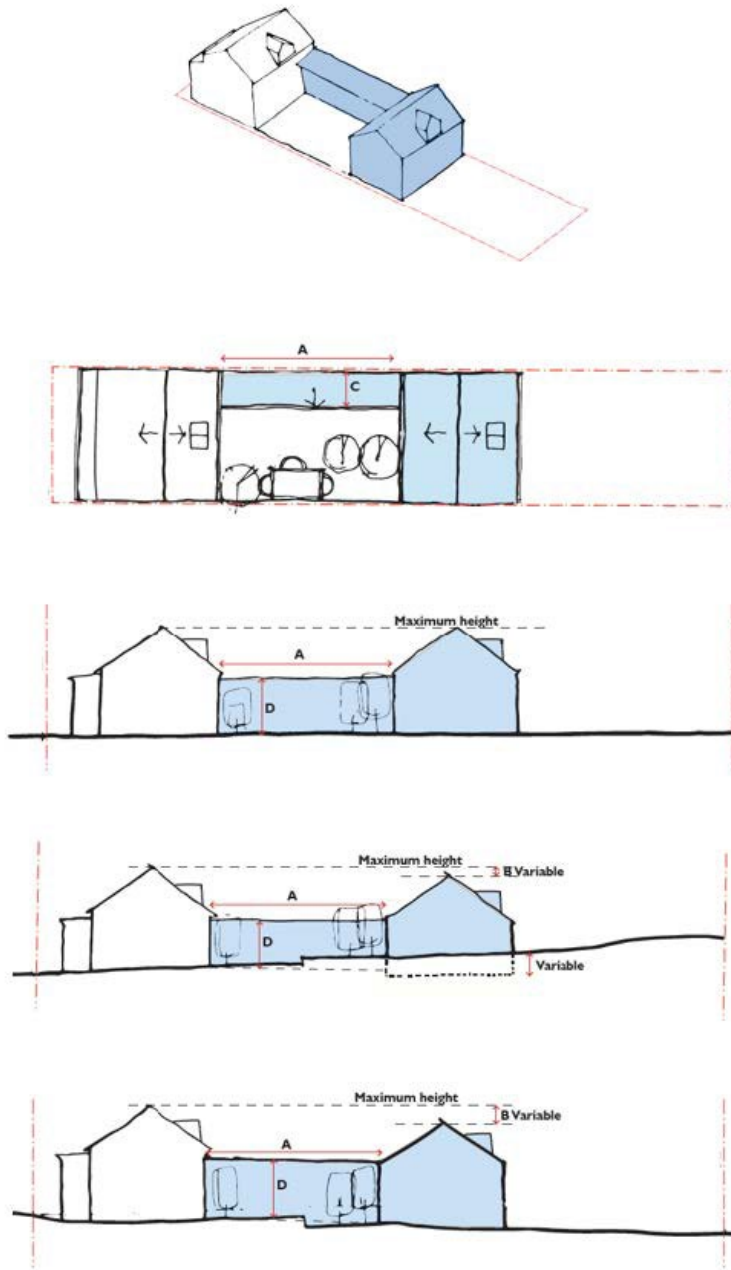




**FIGURE 3A** Non-intrusive development



**FIGURE 3B** Non-intrusive development. Example of a courtyard housing addition with the same pitch, form and orientation as the principal building form.



**Measurement A:** dimension must provide a usable courtyard and must comply with the controls and minimum requirements in Section C1.4.8 - Private open space, swimming pools, courtyards and landscaping - provided that a compliant rear building alignment can be achieved.

**Measurement B:** dimension must provide an addition that is single storey, may be equal to or lower than the ridge height of the principal building form (not including chimneys), and must not be able to be seen over the roof of the principal building.

**Measurement C:** dimension must be a maximum of 1.5m internally.

**Measurement D:** dimension must be a maximum of 2.4m or below the eaves of the principal building form, whichever is lower.

The diagrams in Figures 1, 2A, 2B, 3A and 3B must be read in conjunction with relevant controls which set out detailed additional requirements. The diagrams do not show examples that reflect all the relevant controls.

---

### C1.3.2 Timber buildings

---

Timber buildings within the Paddington Heritage Conservation Area include single storey Victorian workers' cottages, two storey Victorian workers' houses, Early Victorian single storey cottages, Late Victorian terraces and semi-attached timber houses.

All forms of timber buildings contribute to the diverse character of Paddington streetscapes and the aesthetic value of the conservation area. Timber buildings are also significant because of their rarity and historical association with the evolution of the Paddington Heritage Conservation Area.

The vast majority of timber buildings in Paddington are single storey workers' cottages constructed between 1840 and 1870. These buildings were built to accommodate local artisans and working class families who played an important role in the development of the Paddington village.

Timber buildings are vulnerable to change and many have been modified over time, are in a deteriorated condition or suffer from structural instability. Despite these changes timber buildings in Paddington continue to make an important contribution to the character of the conservation area and should be conserved.

#### Objectives

- 01 To retain and conserve timber buildings and their setting.
- 02 To retain, restore and conserve the special characteristics and details of timber buildings.
- 03 To restore and reconstruct missing elements of the principal building form within the street front zone.
- 04 To retain and conserve significant side and rear forms of timber buildings.
- 05 To retain, restore and promote the significance, contribution and relationship of a timber building within the context of the conservation area.
- 06 To ensure that additions and alterations for fire and access upgrading are discreet, and retain and respect the significant building and its fabric.

#### Controls

- C1 Additional storeys are not permitted to the principal building form of timber buildings.
- C2 When works are proposed to the principal building form or original significant elevations visible from the street or lane, Council strongly encourages and may require restoration or reconstruction of missing elements appropriate to the architectural style of the building or reversal of uncharacteristic elements where:
  - a) balconies or verandahs have been enclosed and details such as balustrade panels, rails, columns, friezes and fringes have been removed;
  - b) original door or window types and patterns have been removed;

- c) roof cladding is in a unsympathetic material;
- d) details are missing from chimneys; and
- e) inappropriate reconstruction of period detail and elements has occurred.

Note: Reconstruction and restoration may be guided by traditional models and physical or documentary evidence of an earlier state of the building or architectural style.

- C3 Existing setbacks from the front and side boundaries of the principal building form are to be retained.
- C4 Alterations and additions to the rear of buildings must not dominate or compete with the form, height, proportions or scale of the timber building.
- C5 Where structural stabilisation of a timber building is necessary, a sympathetic structural solution that ensures the conservation of as much original external and internal fabric as possible is required.
- C6 Where alterations to timber buildings are required to meet the provisions of the Building Code of Australia, materials must be consistent with traditional materials and finishes.
- C7 No parking is permitted under or within the principal building form of a dwelling.
- C8 Fire upgrade and access works must be done sympathetically and avoid removal of significant fabric.
- C9 Refer to relevant objectives and controls in section 1.3 - Building types, section 1.4 - General policy for existing buildings and infill development and section 1.5 - Specific policy for building and site elements.

---

### C1.3.3 Corner buildings

---

#### *Corner terrace houses*

Corner terrace housing terminates a terrace row at an intersection street or lane. The form of corner terraces makes an important contribution to views and vistas at street intersections.

Generally they are built to the street boundary, having no setback at all on the side. Frequently the side gable end walls are blank, but sometimes there are windows and balconies.

Materials include stone, brick, stucco, render, cast iron and terracotta.

#### Objectives

- 01 To retain and conserve the architectural detail and special character of corner terraces.
- 02 To ensure that traditional side elevations, forms and alignments are retained.
- 03 To ensure that side additions are of a sympathetic design and construction to the original building.

#### Controls

- C1 Refer to objectives and controls in Section C1.4 General controls for all development and Section C1.5 Specific policy for building and site elements.

#### *Corner shops and corner commercial buildings*

Corner shops and corner commercial buildings are typically one or two storeys in height and are often located at cross streets. Corner shops are usually the corner terrace of a row of terraces, but may be a corner building on their own. Often they have an angled entry elevation, as well as elevations on two street sides, all of which are built to the boundary.

Many corner shops remain as shops but others have been changed to restaurants, cafes, galleries and residences. The typical shop windows are large and face the streets on either corner with the entrance at the corner. Building materials include stone, brick, stucco, render, cast iron, terracotta and some timber.

Corner shops and commercial buildings reflect the neighbourhood evolution of Paddington and have a high social and historical significance.

Note: The controls and objectives in this section apply in addition to the objectives and controls for 'All commercial buildings'. If there are any inconsistencies, these corner controls take precedence.

### Objectives

- O1 To retain and conserve corner shops and corner commercial buildings as distinct building forms and as evidence of the evolution of Paddington.
- O2 To retain and conserve corner shops and corner commercial buildings because of the service they provide to residential neighbourhoods and because they provide a positive contribution to the pedestrian environment of Paddington.
- O3 To encourage the reinstatement of suitable retail and commercial uses within existing shops and commercial buildings in recognition of the social and historic significance of these types of uses and their role in the neighbourhood evolution of Paddington.

### Controls

- C1 Retain original shopfront windows, joinery and architectural details irrespective of a building's use.
- C2 Shopfront windows must remain as showcases and not be obscured by walls or partitions.
- C3 Refer to the objectives and controls in Section 1.3.1 Single storey buildings, Section 1.3.8 Commercial and industrial buildings including shops, Section C1.4 General controls all development and Section C1.5 Specific policy for building and site elements.

---

### C1.3.4 Multi-storey terrace style housing

---

Multi-storey terrace housing includes mostly two and three storey terraces, some containing additional basement and attic levels. This housing was traditionally built in uniform rows; occasionally containing distinct subgroups or individual buildings within groups.

The lot width and configuration is the main determinant of the terrace house size, scale and arrangement pattern, with the three storey terraces generally occurring on the larger lots.

Architectural styles and the periods of construction vary and include Georgian, Victorian and Federation.

Predominantly terraces have front verandahs and balconies built to address the street, and party walls which separate the dwellings.

Groups of terrace houses occasionally contain subgroups of varying building widths and detailing, or may be terminated by an individual end terrace (see Section 1.3.3 Corner buildings) or mixed residential/corner shops and commercial buildings (see Sections 1.3.3 and 1.3.8 ).

#### Objectives

- 01 To retain and conserve the principal building forms of rows, pairs and groups of terraces.
- 02 To retain significant rear and side forms.
- 03 To retain the rear forms of unaltered pairs and groups of terraces.
- 04 To retain the shared distinctive characteristics of pairs and groups of buildings.
- 05 To retain, restore and promote the significance, contribution and relationship of a building within the context of a pair or a group of buildings.

#### Controls

##### All multi storey terrace style development

- C1 Refer to objectives and controls in Section C1.4 General controls for all development and Section C1.5 Specific policy for building and site elements.



---

### C1.3.5 Dwelling houses

---

There is a range of freestanding dwelling houses in the Paddington HCA, including Victorian manor houses, timber cottages and freestanding buildings with terrace style form.

However, freestanding dwelling houses in the context of the Paddington HCA are generally constructed in a terrace style form, and though they tend to abut adjoining buildings they do not share a common party wall with the adjoining dwelling. To that end, these dwelling houses are freestanding, and are distinguished from semi-detached dwellings and attached dwellings as defined in Woollahra LEP 2014.

The dwelling houses include small timber, brick and stone cottages to larger stone and brick mansions. These range from workers' cottages, middle class housing and mansions built on original gentry estates. Examples include single storey buildings, two storey or multi-storey buildings.

A garden setting is often associated with freestanding houses. Within the curtilage there may be associated culturally significant outbuildings.

Refer also to Section 1.3.1 Single storey buildings for additions to single storey cottages.

#### Objectives

- O1 To retain and conserve dwelling houses, their curtilage and settings.
- O2 To ensure that additions to multi-storey dwelling houses do not compromise or dominate the original main front section of the house, and are suited to the architectural style of the building.

#### Controls

- C1 Refer to objectives and controls in Section C1.4 General controls for all development and Section C1.5 Specific policy for building and site elements.

---

### C1.3.6 Residential flat buildings, manor houses, multi dwelling housing and multi dwelling housing (terraces)

---

Residential flat buildings and multi dwelling housing in Paddington generally consist of small two, three and four storey buildings dating from the 1930s to 1950s, taller buildings dating from the 1960s to 1970s, and the infill buildings of the 1990s. This includes some public housing built during the 1950s.

Early building materials include brick and terracotta with the later buildings constructed from masonry, concrete and glass.

Some of these buildings, because of their scale, bulk and materials, are intrusive elements in the general context of Paddington, and therefore are not contributory buildings.

Inter-War flat buildings illustrate the Inter-War development of Paddington. They make an important historic, aesthetic, social and representative contribution to the character of Paddington, demonstrating the key characteristics of architectural styles of the Inter-War period.

#### *General*

#### Objectives

- 01 To mitigate the effects of intrusive residential flat building, manor house, multi dwelling housing (terraces) and multi dwelling housing development.
- 02 To encourage redevelopment or modification of intrusive development.
- 03 To ensure that parking does not detract from the character of the streetscape.

#### Controls

- C1 Redevelopment or modification of intrusive development must be to a design that is appropriate to the relevant aspects of the historic context.
- C2 Alterations and additions that reverse unsympathetic works are encouraged.
- C3 Alterations and additions to intrusive development must be an appropriate response to the historic streetscape and mitigate intrusiveness.

#### *Inter-War flat buildings*

#### Objectives

- 01 To conserve and maintain Inter-War flat buildings and multi dwelling housing in Paddington by ensuring these buildings and their significant characteristics are retained and protected.
  - 02 To conserve the principal street elevations and the character of Inter-War flat buildings.
-

- 
- 03 To ensure that the character of original roofscapes, including key elements such as chimneys, is maintained.
  - 04 To ensure that alterations and additions to the roofs are discreet and do not detract from the original character, proportions or key elements.
  - 05 To conserve the established garden settings, including significant elements and features.
  - 06 To ensure that external materials, details and finishes respect and complement the original building.
  - 07 To ensure that works to balconies and verandahs do not detract from the character and form of Inter-War flat buildings.
  - 08 To ensure that fences, gates and mailboxes are consistent with the character of Inter-War flat buildings.
  - 09 To ensure that internal additions, alterations and repairs retain and respect internal common areas and significant internal character elements.
  - 010 To ensure that the installation and maintenance of security devices does not detract from the character and form of Inter-War flat buildings.
  - 011 To ensure that additions and alterations for fire upgrading and safety are discreet, and retain and respect the original and significant building fabric.
  - 012 To ensure that ancillary development does not detract from the style and character of Inter-War flat buildings and their settings.
  - 013 To promote restoration and reconstruction works to restore significance.

### Controls

- C1 Significant and/or original forms, details, fabrics, materials or finishes of the principal building elevations are to be retained, except for restoration or reconstruction.
  - C2 Changes to the significant forms, details, materials or finishes of the principal building elevations are sympathetic to the style and period of the building.
  - C3 Alterations and additions do not impact on the overall form and character of the building, and are not visually prominent from the public domain.
  - C4 Additions are limited to undercroft areas, roof spaces and the provision of balconies.
  - C5 Alterations and additions are no higher than the existing roof level, and generally retain the original roof form of the building.
  - C6 External windows and doors are repaired or replaced to match the style, materials and finishes of the original building.
  - C7 Existing original fanlights and other openings are retained and sealed from behind, if necessary.
-

- 
- C8 Original leadlight, glass blocks, etched and patterned glazing are retained and conserved.
- C9 Existing original external and internal doors and door hardware are retained and upgraded rather than replaced.
- C10 New additional security elements are in character with the building. Security bars are:
- fitted internally;
  - respect the existing glazing patterns; and
  - painted in a dark recessive colour.
- C11 Original verandahs and balconies to the principal elevation of the building are not enclosed, glazed, or otherwise altered, except to reinstate original detailing.
- C12 New verandahs and balconies are allowed to the rear or side elevations only if they:
- respect the character of the existing building; and
  - are sympathetically integrated with the character and form of the building.
- C13 Alterations to improve accessibility (including lifts, ramps and stairs) are sympathetically integrated with the original building and retain the original character and design of the building and landscape areas.
- C14 Materials are similar in type and finish to those on the original building or sympathetically integrate with the fabric of the building.
- C15 Original face brickwork, terracotta or decorative concrete panels must not be painted, rendered or coated.
- C16 Dormer windows or skylights are not visually prominent from the public domain or the principal elevations of the building. Skylights are flush with the roof surface.
- C17 Original chimneys and their details are retained.
- C18 Privacy screens are discreet and do not impact on the overall character of the building.
- C19 Protruding shade structures, including awnings and canopies, are not located on the principal building elevations.
- C20 The roof maintains traditional roofing materials of the area, such as glazed terracotta tiles. Any replacement or repair matches the original roofing in type, profile, colour and materials. Concrete roofing tiles and corrugated metal roofing are not appropriate.
- C21 Internal common areas and significant character elements are retained. This includes: entry doors, foyer areas and fittings, mailboxes, noticeboards, staircases, balustrades, wall details, light fittings, internal doors and the like.
- C22 New lifts are designed and located so that the addition:
- is located outside the principal building form, if practical; and
  - does not require significant alterations to existing common areas.
-

- 
- C23 Unsympathetic additions and modifications to the building, and its grounds, are to be removed and replaced with sympathetic works, or reinstatement of original forms and matching fabric.
  - C24 Services upgrading and fire safety works must minimise adverse visual impact and damage to original building fabric.
  - C25 Alarm bell boxes and the like, are not attached to the principal building elevations.
  - C26 New or upgraded services are discreetly and sensitively located to minimise visual impact. They are located within existing ducts, behind cornices or bulkheads or within external lightwells that are not visually prominent. Wiring or other services are housed in concealed conduits.
  - C27 Original timber staircases are retained and smoke isolated, if necessary.
  - C28 Where the height of the original stair balustrades is to be modified –the modification is discreet and sympathetically integrated with the existing stair balustrade.
  - C29 Stair treads applied to existing stairs are discreet.
  - C30 Emergency and exit lighting is incorporated into existing original light fittings, where practical.
  - C31 Smoke and/or thermal detectors are discreetly located and do not impact on decorative plaster cornices and ceilings.
  - C32 Car parking and garage structures are located at the rear, with access from the rear lane or side driveway.
  - C33 Original fencing, gates and mailboxes are retained and conserved.
  - C34 New ancillary development:
    - a) is smaller in scale than the principal building;
    - b) is not located between the principal building and the street front, and generally located at the rear behind the principal building;
    - c) is constructed in a style, form, materials and finishes that complement the principal building;
    - d) is single storey with a maximum clear internal height of 2.4m; and
    - e) is sympathetic in scale and style to traditional forms of ancillary structures.
  - C35 Characteristic front gardens, and their elements, are retained with minimal alteration.
  - C36 Structures erected in the front garden do not significantly reduce or compromise the landscaped area or key elements and features.
  - C37 New fences and gates to the front building alignment must complement the streetscape and the existing building.
  - C38 Mailboxes are discreetly located and do not impact on the character of the building.
-

---

Note: Refer also to Section 1.2.5 Contemporary design in Paddington and Section 1.3.14 Intrusive buildings.

### C1.3.7 Buildings in the William Street MU1 Mixed Use Zone

---

The controls in this section apply to land in William Street zoned MU1 Mixed Use under Woollahra LEP 2014. The building types in this MU1 Zone include:

- ▶ residential buildings
- ▶ purpose built commercial buildings;
- ▶ residential buildings which have been lawfully altered for a non-residential use; and
- ▶ residential buildings that retain their residential external appearance and are used for a commercial purposes.

William Street contains a mix of residential terrace buildings as well as shopfronts with residences above; these unite the busy retail promenade of Oxford Street with the dense residential terrace housing of Paddington. Since the 1980s William Street has grown to become a popular location for small fashion specialty shops, and shops with a boutique or artisan character.

It is important that the built form in William Street retains its mix of residential and non-residential building facades. In particular, development of a residential terrace for a commercial use must be undertaken in a sensitive manner to ensure that the overall character of the original building is retained, and that particular elements of the terrace house are sympathetically addressed.

The use of the terrace houses in William Street must ensure that development does not involve the demolition of common walls. This requirement is sought to retain the small scale and low key nature of dwellings and shops within the terraces by preventing amalgamation of buildings.

The ground floor non-residential uses should contribute to, and reinforce, William Street's boutique retailing character. Development should retain and enhance the heritage character of the street, with particular regard to the use of sympathetic external colour schemes and signage.

#### Objectives

- 01 To ensure that work to any building in William Street is consistent with the original character of the building type and its architectural style, and makes a positive contribution to the streetscape.
  - 02 To ensure that a premises originally designed and built for a residential purpose retains a distinctive residential character.
  - 03 To provide a varied streetscape by retaining a mix of residential and commercial external facades.
  - 04 To ensure that development retains and enhances the heritage character of the street.
  - 05 To minimise the impact of non-residential uses on the heritage significance of the street.
-

- 06 To ensure that ground floor commercial uses contribute to William Street’s boutique retailing character.
- 07 To ensure that security devices do not detract from traditional architectural elements, and the amenity and visual presentation of the streetscape.

### Controls

- C1 The use of a residential building for a commercial use is to retain the traditional residential appearance at the street frontage.
- C2 Development must not involve the removal of internal party walls, external common walls or dividing fences between attached terrace buildings, whether or not those buildings are on separate lots.
- C3 Development is to respect the existing traditional façade of the building and not detract from its heritage character through inappropriate materials, finishes, external colours and character elements and the like.
- C4 Traditional architectural elements, including sash windows, inward opening timber panelled front doors, balcony doors, balustrades and palisade fences are to be retained.
- C5 The following works to the street front elevation are not supported:
  - a) replacement of timber double hung sash windows with other window types, such as single sheet glass windows or windows with false glazing bars and the like;
  - i) widening of window and door openings;
  - j) replacement of multiple window openings with a single window opening; and
  - k) replacement of original front doors.
- C6 Fully glazed shopfronts are not permitted on residential buildings.
- C7 Display of goods and all business operations are confined to the building. (Note, in the case of residential terraces, verandahs and balconies are deemed to be external to the building.)
- C8 An outward opening security door in front of a traditionally panelled front door may be permitted if the design complies with Section 1.5.3 Windows, doors, shutters and security.
- C9 Signage is to be integrated with the building and is not to intrude upon the Victorian character of the area. Traditional colours for signwriting include: light brown, rich brown, Indian red, and chrome green. Overly bright colours will not be permitted.
- C10 Individual business branding and identity in external painting and colour schemes is to be subordinate to the main colour schemes in the street.
- C11 In a residential building, signs for shops or other commercial uses are limited to a maximum of two signs per building, being:
  - a) one single sign with a maximum dimension of 500mm high by 450mm wide mounted or painted adjacent to the front door; or
  - b) one single flush mounted wall sign or painted sign within the ground floor verandah blind arch; or
  - c) one projecting wall sign that:

- 
- i) has a maximum area of 300mm x 300mm;
  - ii) does not project more than 500mm from the building façade;
  - iii) does not impact on the decorative stucco of the party wall; and
  - iv) is no lower than 2.6m off the pavement, and no higher than the partywall corbelling.

### C1.3.8 Commercial and industrial buildings including shops

---

Retail and commercial buildings have always been a major feature of Paddington.

For example, Oxford Street is a homogenous Victorian commercial precinct established since the 1860s and is the main shopping area of Paddington. A smaller group of retailers is located at Five Ways, which was established by 1910. More recently, William Street, as an extension of Oxford Street, has emerged as a boutique retailing street adapted from residential terraces.

Other shops are scattered throughout Paddington, mostly on street corners. These shops have survived; many with changed uses and most have a high degree of integrity.

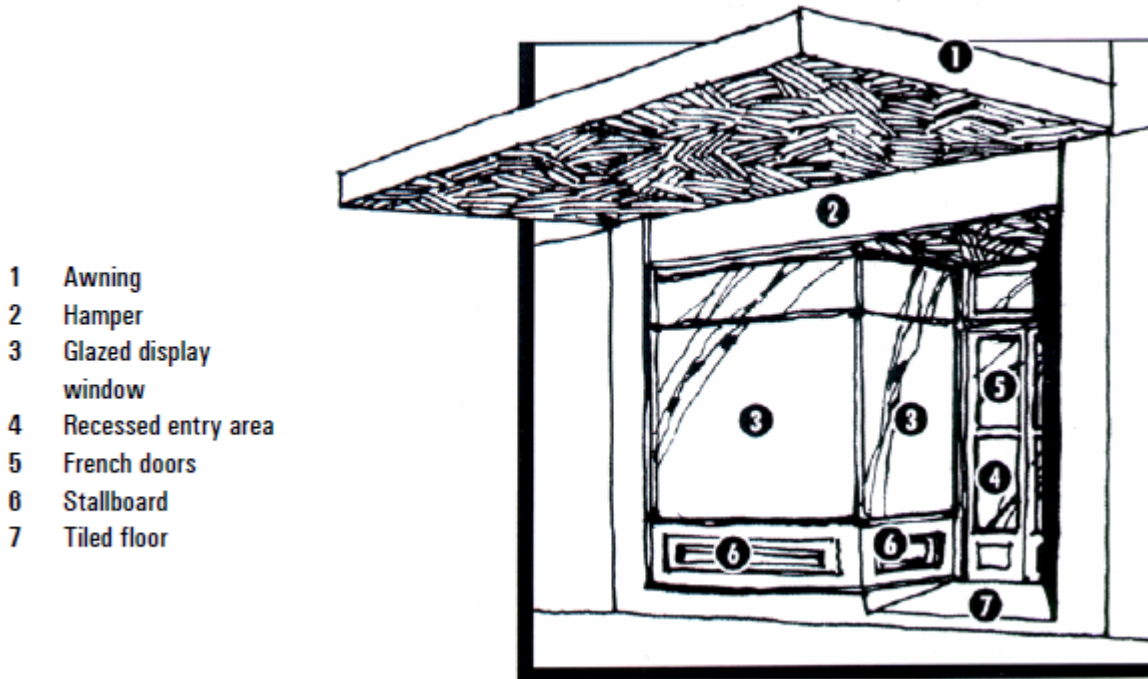
In Oxford Street the general cohesiveness of the streetscape comes from the original above-awning elevations. Decorative parapets are common. Architectural styles include Victorian, Federation and Inter-War and date from the early 1860s to the 1940s. Building materials include stone, brick, stucco, render and timber.

Shops are typically one or two storey in height and include single storey and two storey residential terraces with shopfronts. Shopfronts are stylistically diverse. They include original Victorian shopfronts, and Federation, Inter-War and Post War shopfronts.

Commercial and industrial buildings are also spread throughout the area, with mixed architectural forms and varying degrees of integrity. Industrial buildings include garages, workshops, service stations and light industry factories. These buildings include large single storey buildings constructed from brick and corrugated iron.



**FIGURE 4** Traditional shop front



*All commercial buildings*

**Objectives**

- O1 To retain and conserve forms, significant elevations, details and finishes of commercial, industrial and retail buildings.
- O2 To retain and conserve good representative examples of significant architectural styles in the historic development of commercial retail and industrial buildings in Paddington.
- O3 To retain and conserve original shopfronts.
- O4 To ensure that security devices do not detract from the traditional architectural elements and the amenity and visual presentation of the streetscape.

**Controls**

*General*

- C1 Principal building forms are to be retained.
- C2 Significant architectural elevations and significant finishes and details are to be retained.
- C3 Works for the adaptive re-use of a building must be consistent with the overall character of the building type, its architectural style and its context within the HCA.

- 
- C4 Refer to the objectives and controls in Section 1.2.3 Character elements, Section 1.3.1 Single storey buildings, Section 1.3.3 Corner buildings and Section C1.5 Specific policy for building and site elements.

#### *Shopfront elevation*

- C5 Shopfronts that are examples of significant architectural styles in the historical development of Paddington are to be retained.
- C6 New work to significant shopfronts is to be consistent with the style and character of the building and the streetscape.
- C7 Original windows above the awning are to be retained and not altered in size.
- C8 Shopfronts must not be amalgamated. Where internal spaces of buildings are amalgamated, individual shopfront elements and features such as shop windows and doors must be retained.
- C9 For new buildings and existing buildings where no significant fabric or layout is present in the shopfront, contemporary design is permitted if it is consistent with the building's historic streetscape context in terms of:
- a) materials, colours and finishes;
  - b) proportions of windows and doorways, including the division of windows with their bases and vertical sections;
  - c) detailing; and
  - d) signage.
- C10 Reconstruction of original shopfronts may be permitted where a shopfront forms part of a group or where sufficient evidence exists showing the original shopfront design.
- C11 Removal of original shopfronts or elements of an original shopfront is not permitted except for the purposes of restoration.
- C12 When work is proposed to an intrusive shopfront, reconstruction, restoration or contemporary interpretation according to C6 is required.
- C13 Where awnings are a characteristic element in the streetscape, the awnings must complement the existing streetscape character.

#### *Additional controls for the Five Ways*

- C14 For land zoned E1 Neighbourhood Centre in the Five Ways, regardless of the building type, the replacement of timber double hung sash windows with a single street glass window to the street front elevation may be permitted if consistent with the streetscape context and the characteristics of related buildings.

---

## ***Commercial development in Oxford Street***

### **Character statement**

Oxford Street, Paddington, is positioned on the ridge running from the City of Sydney to Bondi Junction. A traditional main street has developed along the north side of Oxford Street for almost 1.5km from Boundary Street in the west, to Queen Street in the east.

The centre is a predominantly Victorian and Edwardian (Federation) commercial precinct established since the 1860s and is the main shopping area for Paddington. Oxford Street has attracted fashion shops in the last two decades and has transformed from a strip serving the local population to a destination shopping location.

The north side of Oxford Street is characterised by continuous development with a very consistent architectural scale and character. The built form in Oxford Street consists of shopfronts with a cohesive streetscape established by the original above awning elevations. Decorative parapets are common. Architectural styles are predominantly Victorian and Edwardian buildings with some later Inter-War buildings. Building materials include stone, brick, stucco and timber.

The south side of the road is in the City of Sydney local government area. It contains a number of institutional and civic buildings, interspersed by small groups of commercial buildings. A popular Saturday market also operates on the south side of Oxford Street within the Paddington Public School and the Uniting Church.

Increasing traffic on Oxford Street has impacted on the pedestrian environment, which compromises the interrelationship between the north and south sides of Oxford Street.

### **Desired future character**

The character of Oxford Street is defined by its heritage items and contributory buildings generally in the form of two storey buildings with parapet façades establishing a consistent street wall. There are also some distinctive and contributory buildings interspersed amongst the regular shops, including the Post Office building, Juniper Hall and the Imperial Hotel.

The street is part of the Paddington Heritage Conservation Area, and the desired future character is to retain the existing built form and established urban character. Development will primarily involve the adaptive re-use of existing buildings and rear additions.

To ensure the conservation and enhancement of heritage items and contributory buildings, development is to respect the design of neighbouring buildings and the conservation area generally in regard to significant fabric and façade characteristics, scale, massing, materials, details, orientation and setbacks.

The retail vitality of Oxford Street needs to be reinforced. Oxford Street is a destination precinct, attracting shoppers to its boutiques and designer fashion shops from outside the local area. There is a need to continue to encourage fashion retail uses, supported by cafes and restaurants and other active ground floor uses, and to re-establish the strip's role in serving the local community. The development of residential uses may occur as part of mixed use buildings on upper levels.

---

## Objectives

- 01 To reinforce and build on the precinct's reputation as a boutique shopping main street.
- 02 To provide for a mix of active ground floor uses that contribute to the vitality and viability of the centre.
- 03 To retain and restore the original shopfront windows, joinery and architectural details.
- 04 To maintain the consistent street wall and frontage height of Oxford Street.
- 05 To ensure that building materials, details, colours, materials and finishes are sympathetic to the conservation values of the street.
- 06 To ensure that roof and parapet forms contribute to the established character of Oxford Street.
- 07 To ensure that side elevations, particularly those that are visually prominent, do not detract from the visual character of the street.
- 08 To ensure that corner buildings are designed to provide important elements in the physical pattern of the street and contribute to the perception of distinct blocks and groups of buildings.
- 09 To ensure that awnings provide a consistent element within the streetscape.
- 010 To provide shade and wet weather protection for pedestrians.
- 011 To encourage opportunities for rear development on deep and narrow sites, particularly those sites with rear lane access.
- 012 To provide a sympathetic transition in built form and uses between the residential areas and the Oxford Street commercial strip.
- 013 Infill development is to respect the design of neighbouring buildings and the character of the conservation area in regards to scale, massing, materials, details, orientation and setbacks.
- 014 To ensure that advertising signs and structures respect the heritage and architectural character of individual buildings and the street as a whole.

---

## Controls

- C1 The ground floor must contain active uses that add to the pedestrian experience on the street:
    - a) retail uses including fashion boutiques and cafes; and
    - b) non-retail uses, such as entertainment facilities, must provide strong visual connection with the street and retain and conserve the traditional shopfronts established by the predominant retail frontages.
  - C2 The adaptive re-use of a building must be consistent with the overall character of the building type, its architectural style and its context within the heritage conservation area.
  - C3 Uses must protect existing shopfronts and street elevations and must not compromise the established pattern and rhythm of frontages and the heritage character of the street.
  - C4 The height of development must conform to the predominant heights of adjacent buildings and the prevailing wall height in the streetscape.
  - C5 Development must respect the relationship of building heights to view corridors and the skyline.
  - C6 New balconies are not encouraged on the Oxford Street frontage other than to reinstate an original awning/balcony and support columns.
  - C7 Alterations and additions to heritage items and contributory buildings must retain original shopfronts. Fully glazed shopfronts are not permitted.
  - C8 Sympathetic use of contemporary design and materials may be considered.
  - C9 Uncharacteristic elements or structures should be removed, and missing elements reinstated.
  - C10 The range of colours, materials and finishes of new building work should complement existing heritage and contributory buildings, particularly above the awning line.
  - C11 Colour schemes are to be appropriate to the individual building and the street as a whole. Extreme colour schemes diminish unity and detract from the streetscape, particularly if above the awning line.
  - C12 Colour schemes to the under awning façade may have greater variety and visual interest, but should not detract from the established streetscape character.
  - C13 Parapet height and rhythm is to be consistent. Parapets should predominantly be masonry.
  - C14 Infill development should include parapets and roof forms that respect the existing conditions in terms of parapet height, pitch and shape of roofs.
  - C15 Architectural elements of side elevations are to be retained, restored or reconstructed.
  - C16 Corner sites are to be designed to maintain visual prominence in the street wall of Oxford Street. This is generally achieved through architectural elements such as parapet walls.
  - C17 New corner buildings are to address both street frontages.
-

- C18 Awnings are reinstated in the original location, where evidence of the original structure exists.
- C19 Rear extensions should be designed to:
- a) improve casual surveillance and vibrancy of rear lanes;
  - b) minimise impact to significant landscape elements; and
  - c) protect the privacy and amenity of adjoining or adjacent residential uses.
- C20 New buildings must maintain and reflect:
- a) the established patterns and proportions of existing elevations which consist of a horizontal orientation below the awning line and a more vertical character above the awning line;
  - b) the consistency of horizontal and vertical façade features such as window heights and widths, bay widths, awning and parapet lines;
  - c) the established rhythm and pattern in the street arising from the original subdivision pattern; and
  - d) existing setbacks (generally zero setbacks) to front and side boundaries.
- C21 Above awning advertising signs are not permitted.
- C22 Signs and advertising must comply with the controls for advertising signs on buildings in Part E of this DCP, Chapter E7 Signage.

---

### C1.3.9 Pubs

---

Pub buildings are located throughout Paddington and have important historical, aesthetic and social significance that contribute to Paddington's character. Most pubs in Paddington are substantial buildings ranging in height from two to four storeys. They date from the 1840s through to the 1940s and are prominent place markers, often located on corner sites.

The pubs have an imposing presence with distinctive parapet profiles, modulated façades, window and door openings and ornate architectural detailing. Building materials include stone, brick, stucco, timber, glazed tiles and terracotta. The pubs display a diverse range of architectural styles including Victorian, Federation and Inter-War buildings.

Some buildings exhibit original elevation detail and a few retain their original interior detail.

Pubs owe their survival to their ability to offer the latest in comfort, service and amenities, consistent with the demands of their customers. To meet these situations and to also comply with legislative requirements relating to matters such as trading hours and public amenity, alterations and additions to pubs occur from time to time. Despite the fact that pubs are prone to physical change, a number of Paddington pubs remain close to their original configuration, appearance and use.

Some pubs may have been converted to other uses, including (but not limited to) residential, office premises or community centres. However, their exterior form retains its distinctive pub appearance which contributes to Paddington's character.

This section of the DCP applies to all buildings that are currently or were formerly a pub.

Note: A Pre-DA meeting is recommended for major changes to pubs or former pub buildings in Paddington. Council may require the submission of a Conservation Management Plan, subject to the extent of changes.

#### Objectives

- 01 To ensure that the external integrity, scale, character and relationship of a pub building with the surrounding streetscapes remain unaltered.
- 02 To ensure alterations and additions are sympathetic and respect the heritage significance of pub buildings.
- 03 To protect interiors that contribute to the heritage significance of a pub or that date from significant phases of development.
- 04 To retain original names of pubs as part of the historical and social significance of Paddington.
- 05 To retain residential accommodation within pubs.
- 06 To support the continued role and presence of pub buildings in Paddington even in the event of an adaptive re-use.
- 07 To remove uncharacteristic elements or structures.

- O8 To retain original roof forms and appearances of pub buildings in Paddington.
- O9 To protect and retain moveable heritage.
- O10 To ensure that advertising signs and awning structures respect the heritage and architectural character of pub buildings.

## Controls

### *Internal*

- C1 Significant interior features are to be retained.
- C2 Missing significant internal elements, details and finishes should be restored or reconstructed. These include:
  - a) decorative ceilings;
  - b) significant materials and finishes including (but not limited to) tiles, timber panelling and wall papers;
  - c) joinery, including stairways;
  - d) fittings, including light fittings; and
  - e) traditional signs and advertising.
- C3 Original room configurations must remain discernible. Where new openings are proposed, interpretation of original wall positions and room proportions should be provided, such as portal frames, nibs or bulkheads.
- C4 Moveable heritage and other significant heritage artefacts must be retained in their context.
- C5 Fire upgrade measures must be done sympathetically and avoid removal of significant fabric.

### *External*

- C6 Original elevations must be retained and conserved.
  - C7 Face brick and tiles are not to be painted over, rendered or retiled.
  - C8 Significant external features are to be retained and maintained. Where appropriate, missing elements, details and finishes should be restored or reconstructed. These include:
    - a) pressed metal ceilings to awnings;
    - b) awnings and balconies;
    - c) traditional signage;
    - d) typical features of an architectural style;
    - e) significant doors and openings; and
    - f) significant materials and finishes (including but not limited to wall tiles).
-



- C9 The restoration of missing detail or reversal of unsympathetic work to street front elevations is required when work is undertaken to the principal elevations.
- C10 The original name of a pub must be retained and displayed appropriately in signage.
- C11 Traditional hotel signage and product advertising, such as painted glass panels advertising beer brands, wall signs and awning signs should be retained, protected and displayed.
- C12 When awnings are to be reinstated, they are to be reinstated in the original location and must complement the existing streetscape character.
- C13 The prominence and form of parapets and roof lines must be retained. Additional levels are not to be visible from the public domain.
- C14 The original massing and scale, pattern and modulation of façades and the proportions of openings must be retained.
- C15 Mechanical plant equipment (including communications, electrical, air-conditioning and kitchen exhaust systems) must not adversely impact the roof form or be visible from the public domain.
- C16 Alterations and additions must be consistent with heritage management documents.
- C17 Reconstruction and repair works are to use traditional materials and techniques in accordance with best heritage practice and a heritage management document.

---

### C1.3.10 Places of public worship and educational establishments

---

Since the 1840s Paddington has always had a strong church and school presence but over time many church and school buildings have been demolished and have been replaced with other types of buildings.

The remaining churches include St George Anglican Church built in 1888 and The Church of Christ built in 1901. Both are masonry with the latter being a much smaller building.

Schools in Paddington include Glenmore Road Public School built of stone and brick in 1884, and Edgecliff Preparatory School built of masonry.

#### Objective

- O1 To ensure that any new work is carried out with due regard to the significance of the building and its setting.

#### Controls

- C1 Refer to objectives and controls in Section 1.2.3 Character elements, Section C1.4 General controls for all development and Section C1.5 Specific policy for building and site elements.
- C2 Work undertaken on heritage items must comply with the management policies in a conservation management plan, where such a plan is required by Council.
- C3 For schools, refer also to objectives and controls in Part F of this DCP, Chapter F2 Educational Establishments.

---

### C1.3.11 Public buildings

---

Remaining public buildings in Paddington include the post office and the police station (former courthouse).

The post office is a two storey stuccoed masonry building in the Victorian Free Classical style. Built in 1885, its features include a parapet tower on the western end and a colonnaded loggia between the tower on the west and the curved corner pier on the east.

The former court house building was designed in the Victorian Italianate style and built in the 1880s. Situated between terrace houses it has a recessed portico with a central entrance. Main materials are stuccoed brickwork.

#### Objectives

- O1 To ensure that any new work is carried out with regard to the significance of the building.
- O2 To encourage the ongoing use of public buildings.

#### Controls

- C1 Refer to objectives and controls in Section 1.2.3 Character elements, Section C1.4 General controls for all development and Section C1.5 Specific policy for building and site elements.
- C2 Work undertaken on heritage items must comply with the management policies in a conservation management plan, where such as plan is required by Council.

---

### C1.3.12 Existing contemporary infill

---

Existing contemporary infill refers to buildings (generally 1970 to the present) that occur between terrace style housing. Materials often include rendered brickwork, concrete and glass and architectural styles referred to as modern, 'Sydney School', contemporary or post-modern.

#### Objectives

- O1 To ensure that any new work has regard to the building's context.
- O2 To ensure that any new work does not detract from the architectural merit the building may possess.

#### Controls

- C1 Refer to relevant objectives and controls in Section 1.2.3 Character elements, Section C1.4 General controls for all development, Section 1.1.13 Infill development (new development) and Section C1.5 Specific policy for building and site elements.
- C2 Where the building is not intrusive, additions are to be consistent with the character of the existing building and the massing of existing development within the streetscape.

### C1.3.13 Infill development (new development)

The term ‘infill development’ is defined as the erection of a building that is:

- constructed on an existing vacant registered allotment of land; and
- does not include side, rear or front alterations and additions to an existing building.

**Note:**

Demolition is generally not supported. All proposals for demolition of a building must be approved via a thorough planning process that includes an assessment of the contribution the building is making to the Paddington Heritage Conservation Area, a fabric analysis and an assessment of the impact that the loss of the building may have on the significance of the heritage conservation area.

Infill development provides the chance for the continuing enrichment of Paddington by adding new built form which is an expression of contemporary life.

Opportunities for infill buildings may occur where existing buildings have been demolished or where vacant allotments exist or have been created. Demolition and subdivision will require assessment through the development application process.

As the opportunities for infill development are rare, designs for such sites are required to demonstrate an appropriate response to context and an approach which enhances the character of Paddington and its cultural significance.

Infill development should not be a ‘faux’ representation of a historical architectural style. Rather, Council requires a contemporary design approach which respects:

- the historic context;
- siting; and
- architectural forms (including roof form, roof pitch, height, scale, massing, alignment, modulation, articulation and materials);

and achieves a cohesive relationship between the existing and new urban fabric.

**Note:**

A Pre-DA Meeting is recommended between Council representatives and the applicant for infill development proposals.

The following information is to be submitted for comment for discussion at the Pre-DA Meeting:

- a draft site and context analysis;
- design options explored and the applicant’s preferred infill design proposal;
- a statement outlining the proposed measures to minimise the adverse impact of the infill development on neighbouring lands, including the public domain;
- the philosophy of how the design elements relate to the proposal’s context in terms of architectural form, materials and character; and
- the historic context and impact sections of a draft statement of heritage impact.

For development applications, applicants are required to provide the following information, not limited to:

- ▶ design options and final preferred design;
- ▶ a detailed site and context analysis;
- ▶ profiles of adjoining development;
- ▶ RLs for the subject site and adjoining properties;
- ▶ an accurate survey for the subject site (including levels of adjoining buildings and their architectural elements);
- ▶ a schedule of materials, finishes and colours. Where contemporary materials are proposed, a statement must be provided that outlines how the contemporary materials are in keeping with the character elements and desired future character of the heritage conservation area, particularly in terms of solid-to-void ratios, detailing and proportions, textures and finishes;
- ▶ the structural relationship with adjoining properties (including shared party walls, footings and chimneys); and
- ▶ the final version of the statement of heritage impact.

Other required documentation to be submitted with the development application can be found in the Development Application Guide.

### Objectives

- 01 To encourage development on infill sites which reflects contemporary values and employs contemporary design, and through a design idiom, materials and construction technique provides an appropriate response to relevant aspects of the historical context of Paddington.
- 02 To ensure new development on infill sites is designed and located to achieve a cohesive relationship between new and existing urban fabric, and which retains and enhances the cultural significance of the heritage conservation area.
- 03 To ensure infill development respects the scale and setting of adjacent contributory buildings.
- 04 To protect the amenity of adjoining or adjacent residential uses.
- 05 To ensure that infill development does not prevent the maintenance and conservation of elements that contribute to the significance of the heritage conservation area.

### Controls

#### *General*

- C1 Infill development is to comply with all relevant objectives and controls listed elsewhere in this chapter of the DCP. These objectives and controls are contained in sections including (but not limited to) C1.4 and C1.5.

- C2 If development is for a dual occupancy, the additional controls for dual occupancies in Part B, Chapter B3 General Development Controls of this DCP also apply (refer to Section B3.8 Additional controls for development other than dwelling houses).

*Character*

- C3 Infill development must:
- a) maintain the significant features and qualities that combine to represent the character of the neighbourhood and area;
  - b) not adversely affect the maintenance of elements that contribute to the significance of the heritage conservation area, for example sandstone walls; and
  - c) make a positive contribution to the character of the neighbourhood and area.

*Scale*

- C4 Infill development must not overwhelm its context and should be consistent with the predominant scale of significant contributory development adjoining the site or within the group/row. The scale of infill development must respect and take cues from the lowest adjoining contributory 19<sup>th</sup> or 20<sup>th</sup> century development in terms of:
- a) maximum height pattern (measured to the uppermost ridge of the principal buildings [or the base of the parapet where existing], not including chimneys); and
  - b) massing (building volume and size). On sloping streets, the stepped transitional height pattern must be achieved.

Refer also to Section 1.4.5 Building height, bulk, form and scale.

*Form*

- C5 Infill development must be consistent with the predominant built form (volume and configuration) of significant contributory development adjoining the site and in its immediate area in terms of aspects including, but not limited to:
- a) roof forms and pitch;
  - l) three dimensional modelling of neighbouring buildings;
  - m) modulation and articulation;
  - n) relationship of solids and voids;
  - o) fenestration patterns; and
  - p) relationship of floor to ceiling heights and horizontal alignment of features (especially ground and first floor levels of existing buildings on sloping sites and streets).

Refer also to Section 1.4.4 Roofs and roof forms, Section 1.4.5 Building height, bulk, form and scale, and Section 1.4.6 Site coverage, setbacks and levels.

---

### *Siting*

- C6 Infill development must adopt the established orientation pattern of the streetscape.
- C7 Where neighbouring buildings are orientated to face the street, infill development is to adopt the existing pattern of orientation.
- C8 Orientation across the site is not permitted unless there is a dominant pre-existing pattern in the street.
- C9 Where there is a uniform building front setback, the infill development must align with the existing setbacks of adjoining buildings.
- C10 Where building front setbacks vary, the following apply:
- If there is a dominant pattern and the infill development adjoins that pattern, the infill development must align with that pattern.
  - If there is no dominant pattern, the infill development must align with the existing adjoining development whose scale is more compatible with the proposed infill development. The pattern of setbacks must respect and take cues from the nearest contributory 19th or 20th century development and ensure that infill is recessive and does not visually dominate the streetscape.
  - If there is an existing stepped pattern, the infill development must be consistent with the pattern and proportion of the step.
  - If the infill development occurs on a corner site, the infill development must be sited on the street property boundaries to define the corner.
- C11 Rear and side setbacks (including side passages) must align with existing patterns, where visible from the public domain.
- C12 Infill development must be sited to:
- include sufficient deep soil landscaped area; and
  - have no adverse impact on significant trees on the site or adjoining land, including public land.
- Refer also to Section 1.4.8 Private open space, swimming pools, courtyards and landscaping.

### *Materials, finishes, textures and colours*

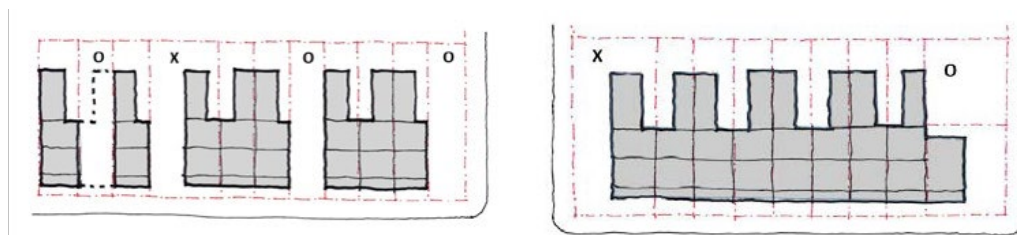
- C13 Materials, finishes, textures and colours must be appropriate to the historic context. They must be similar to the characteristic materials, finishes, textures and colours of the existing contributory buildings within the streetscape.
- C14 Traditional materials may be used.
- C15 Contemporary materials may be permitted for infill development but only where their proportions, detailing, quantities and location on the building are in keeping with the character elements (refer to C1.2.3), the desired future character (refer to C1.2.4) and the heritage significance of the conservation area.
-



Note: for C13-C15:  
 Table 2 below sets out appropriate materials and finishes permissible for infill development.  
 Refer also to Section 1.5.9 Exterior colours.

**C16** Infill development must:

- a) use render, masonry and/or timber;
- b) avoid large expanses of glass, reflective and metal wall cladding;
- c) use roof cladding which conforms with contributing neighbouring development;
- d) not have solid masonry front boundary walls; and
- e) use colour schemes which respect the character of the neighbourhood.



O = Acceptable infill site X = Unacceptable infill site

**TABLE 2** Materials and details for infill development

Building component	External building materials
<b>Roofs</b>	
Permitted	<ul style="list-style-type: none"> <li>▶ Traditional roof materials including natural slate such as Welsh slate and South Australian slate, corrugated galvanised iron in short lengths and associated galvanised details and fixings, or unglazed terracotta tiles.</li> <li>▶ Pre-painted corrugated steel in light to mid grey tones, similar in appearance to traditional corrugated iron.</li> <li>▶ Contemporary corrugated profile sheeting in appropriate colours and subject to low reflectivity.</li> </ul>
Intrusive - not permitted	<ul style="list-style-type: none"> <li>▶ Concrete roof tiles.</li> <li>▶ Non-traditional metal roof profiles.</li> <li>▶ Glass (other than permitted in skylights).</li> </ul>

Building component	External building materials
<b>Walls</b>	
Permitted	<ul style="list-style-type: none"> <li>▶ Traditional wall materials including sandstone blocks, timber weatherboard and brick.</li> <li>▶ Corrugated galvanised iron, zinc coated corrugated steel ripple iron for small expanses only. Must be in appropriate colours and subject to low reflectivity.</li> <li>▶ Rendered brick, with or without inscribed ashlar coursing where appropriate.</li> <li>▶ Fibrous cement sheeting with a rendered and painted finish - for rear additions but only if window reveals of minimum 100mm external depth are achieved.</li> </ul>
Intrusive - not permitted	<ul style="list-style-type: none"> <li>▶ Smooth, textured or profiled face brick and exposed concrete blocks.</li> <li>▶ Stripped sandstock brickwork.</li> <li>▶ Circular pattern render (mock Spanish).</li> <li>▶ Glazed walls and glass bricks.</li> <li>▶ Metal wall cladding.</li> <li>▶ Metal mesh or perforated metal screens.</li> </ul>
<b>Windows</b>	
Permitted	<ul style="list-style-type: none"> <li>▶ Timber frames.</li> <li>▶ Steel frames on rear ground floor only.</li> <li>▶ Metal frames for ground floor shops and commercial premises where appropriate.</li> <li>▶ Plain clear glass.</li> <li>▶ Coloured and patterned glass for replacement in appropriate situations.</li> <li>▶ Fine metal frames in neutral tones.</li> </ul>
Intrusive - not permitted	<ul style="list-style-type: none"> <li>▶ Window walls.</li> <li>▶ Bubble glass.</li> <li>▶ Glass blocks.</li> <li>▶ Timber or metal frames not reflecting traditional proportions.</li> <li>▶ Roller shutter security and sunscreen windows.</li> <li>▶ Horizontally sliding windows.</li> <li>▶ Aluminium framed windows in the front elevation and at the upper levels at the rear</li> </ul>

Building component	External building materials
<b>Doors</b>	
Permitted	<ul style="list-style-type: none"> <li>▶ Timber-framed panelled doors.</li> <li>▶ Glazed timber-framed doors.</li> <li>▶ Glazed steel-framed doors.</li> <li>▶ Glazed doors with film/frosted detailing.</li> </ul>
Intrusive - not permitted	<ul style="list-style-type: none"> <li>▶ Fully glazed doors to the street front elevation of residential properties.</li> <li>▶ Hollow core and timber doors with detail and panels inappropriate to the architectural style of the building.</li> <li>▶ Aluminium framed doors within the front elevation and at the upper levels at the rear.</li> <li>▶ Roller shutter doors to residential houses, retail and commercial premises.</li> </ul>
<b>Shutters</b>	
	<ul style="list-style-type: none"> <li>▶ Traditionally detailed timber louvered shutters are applicable for windows and French doors on some building types.</li> </ul>
<b>Verandahs</b>	
Permitted	<ul style="list-style-type: none"> <li>▶ Traditional flooring materials including stone flagging, marble, tessellated tiles, terrazzo, slate, timber.</li> <li>▶ Polished concrete and large form modern tiles.</li> <li>▶ Traditional post materials including stone, cast iron or timber.</li> <li>▶ Materials similar to traditional materials but without elaborate detailing.</li> </ul>
Intrusive - not permitted	<ul style="list-style-type: none"> <li>▶ Pebble-crete.</li> <li>▶ Polycarbonate or similar type material for roofs.</li> <li>▶ Glass roofs to street elevations.</li> <li>▶ Concrete roof tiles.</li> <li>▶ Non-traditional metal roof profiles.</li> </ul>

Building component	External building materials
<b>Balconies</b>	
Permitted	<ul style="list-style-type: none"> <li>▶ Traditional materials including corrugated iron roofing, slate roofing, timber framing, timber floors, timber balustrades/handrails, cast iron balustrades/handrails or modern-day equivalents.</li> <li>▶ Pre-painted corrugated steel in light to mid grey tones, similar in appearance to traditional corrugated iron.</li> <li>▶ Copper sheeting, zinc sheeting (traditional standing seam profile).</li> <li>▶ Contemporary corrugated profile sheeting in appropriate colours and subject to low reflectivity.</li> <li>▶ Masonry and metal, other than perforated metal or mesh.</li> </ul>
Intrusive - not permitted	<ul style="list-style-type: none"> <li>▶ Smooth, textured or profiled face brick and exposed concrete blocks.</li> <li>▶ Corrugated and other profiled metal sheeting balustrading.</li> <li>▶ Wire balustrading.</li> <li>▶ Fibrous cement sheeting balustrading.</li> <li>▶ Glass balustrading.</li> <li>▶ Perforated metal or mesh screens.</li> </ul>
<b>Front Fences</b>	
Permitted	<ul style="list-style-type: none"> <li>▶ Traditional fences but with consideration to building style and context, including rendered masonry with ashlar coursing, timber (picket or paling), iron palisade on sandstone, brick or rendered bases, brick and timber, or brick with iron inserts.</li> <li>▶ Contemporary interpretation of traditional fence details and materials such as iron palisade and timber.</li> </ul>
Intrusive - not permitted	<ul style="list-style-type: none"> <li>▶ Smooth, textured or profiled face brick, exposed cement blocks, Ti Tree (brush), or sheet metal fences.</li> <li>▶ Angled vertical blade palisade fencing.</li> <li>▶ Full height brick fences.</li> <li>▶ Materials and forms that are inappropriate to the style of the building.</li> </ul>

---

### C1.3.14 Intrusive buildings

---

Intrusive buildings within Paddington are generally 20th century buildings constructed after World War II. These are characterised by scale, proportions, materials and design idioms which are inappropriate to the significant historic character of Paddington.

Intrusive development adversely affects adjoining buildings, the streetscape and the general character of Paddington.

#### Objectives

- O1 To mitigate the adverse impact of intrusive development.
- O2 To encourage appropriate redevelopment of identified intrusive development.

#### Controls

- C1 Alterations must mitigate the impact of the scale, proportions, materials and design idioms of intrusive buildings and improve the relationship of these buildings to the streetscape.
- C2 Design for development on intrusive sites must demonstrate the application of contemporary design techniques, materials and finishes, scale, form, massing, details orientation and setting that respect the character of the adjacent historical context. The design must make a positive contribution to the character of Paddington.
- C3 Alterations must retain existing setbacks from side and front boundaries.

---

## C1.4 General controls for all development

This section applies to all development, including existing buildings and infill development.

The objectives and controls in this section seek to ensure that development is designed to respect the architectural character of the building and the context of the streetscape within Paddington.

The matters addressed in this section are:

- ▶ 1.4.1 Principal building form and street front zone of contributory buildings ;
- ▶ 1.4.2 Side elevations to streets and lanes;
- ▶ 1.4.3 Rear elevations, rear additions, significant outbuildings and yards;
- ▶ 1.4.4 Roofs and roof forms;
- ▶ 1.4.5 Building height, bulk, form and scale;
- ▶ 1.4.6 Site coverage, setbacks and levels;
- ▶ 1.4.7 Excavation;
- ▶ 1.4.8 Private open space, swimming pools, courtyards and landscaping;
- ▶ 1.4.9 Views;
- ▶ 1.4.10 Acoustic and visual privacy; and
- ▶ 1.4.11 Land subdivision and site amalgamations.

The controls in this section are to be read in conjunction with the controls in:

- ▶ Section C1.3 Building types; and
- ▶ Section C1.5 Specific policy for building and site elements.

---

### C1.4.1 Principal building form and street front zone of contributory buildings

---

Paddington is located in a natural amphitheatre with a variable and intricate street and laneway pattern, so views towards and within Paddington are often characterised by the juxtaposition of terrace houses responding to the changes in direction or slope.

Architectural detail and landscaping elements of the principal building form and street front zone may be individual to a particular building or repeated within a distinct group of terrace buildings. There exists subtle variation in these details throughout the heritage conservation area.

The loss of significant original fabric, in particular of the principal building form and street front zone, weakens the integrity of the heritage conservation area. Where work is proposed to the principal building form and the street front zone, reconstruction or restoration of missing elements and the removal of unsympathetic elements is encouraged. New work should be carefully designed sympathetically within the significant historic fabric.

#### Principal building form

The principal building form is the original front building section within a street frontage (see definition). The principal building form, particularly the front façade, is an aspect of exceptional significance of the heritage conservation area, facilitating the understanding of the significant development of the terraced suburb from the mid-19th century onwards.

The principal building form includes the fronts, sides, rears and roofscapes of the original front building section, and is often two rooms deep extending the full width of the property beneath a pitched roof.

External elements of the facades which are of importance include balconies and decorative balustrades, fin walls and arched recesses and original doors and windows. External elements of the roof which are of importance include, but are not limited to, original roof cladding and stepped flashing, parapets, decorative detail such as urns and ridge cappings, chimney stacks, chimney pots, form and scale.

#### Interiors

The interior of the principal building form is also of significance to the heritage conservation area. Surviving original fabric and layouts have the ability to demonstrate the significant 19th century character. Original elements which are considered of significance include, but not limited to, timber floors, fireplaces, decorative plasterwork and distinctive joinery.

Council does not support the gutting of interiors of terrace houses that contain significant original fabric. The objectives and controls in this part of the DCP identify approaches that applicants should take to prevent loss of significant fabric.

The objectives and controls also address the potential impact of weakening key internal walls through partial or total removal, in particular walls lateral to the party or common walls. The internal walls offer lateral bracing to the party walls and are an important element in the overall structural integrity of the terrace house and its neighbours in the terrace group. Accordingly, the removal of these walls essentially weakens the fabric of both the individual terrace house and of the terrace group.

While the retention of internal walls is important to interpret the historic layout of the building, their retention is also important in order to retain structural stability for terrace buildings. Partial demolition of internal cross walls within the principal building form may be considered where suitable interpretation of the position of walls and room proportions is provided and the structural integrity of the buildings is not compromised.

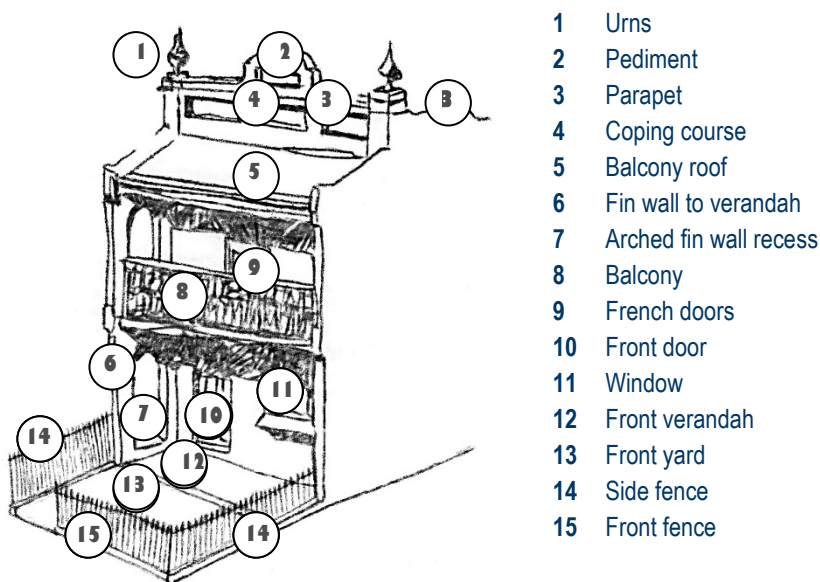
### Street front zone of contributory buildings

The street front zone establishes the connection between the private and the public domain. The predominant building form in Paddington is terrace style housing (generally attached dwellings or semi-detached dwellings as defined in Woollahra LEP 2014), which usually forms a continuous street front along the streets and steps down the hillside. The street front zone comprises the front building elevation and visible roof, front yard, the side boundary fences in the front yard and the street boundary fence.

The street front zone also has a landscaped character, with features which enhance the architectural character of the building and contribute to the historic streetscape.

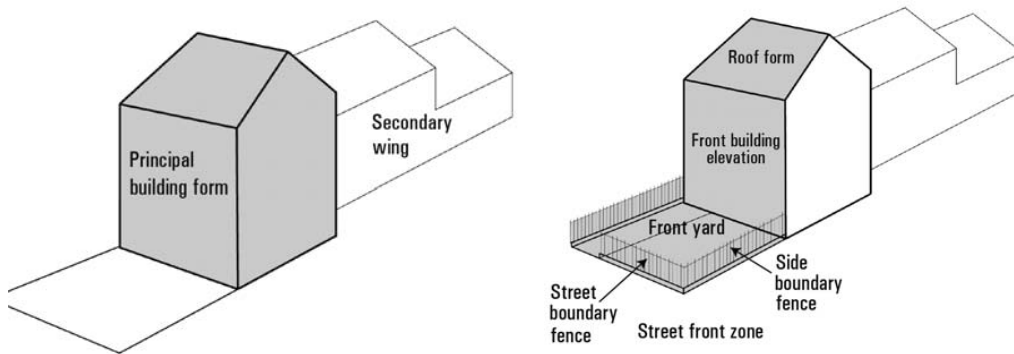
There are many variations in the relationship of the building to the street. Some simple Georgian style buildings are built on the edge of the pavement. Others are set back from the street with gardens. A typical Victorian period terrace has an iron palisade fence, a small garden, a path and a verandah, the latter two elements often incorporating decorative tiling. Its principal street front elevation is embellished with a high concentration of detail.

**FIGURE 5** Typical Victorian street front elevation





**FIGURE 6** Principal building form, secondary wing and street front zone.



### Objectives

- 01 To retain and conserve the principal building forms and street front zones.
- 02 To restore or reconstruct missing elements of the principal building forms and within the street front zone.
- 03 To encourage the removal of uncharacteristic elements or structures.
- 04 To promote design that conforms to the existing character of the area.
- 05 To reverse inappropriate reconstruction work.
- 06 To retain the distinctive shared characteristics of groups of buildings.
- 07 To retain, restore and promote the significance, contribution and relationship of a building within the context of a group of buildings.
- 08 To conserve the significant original fabric of terrace houses, terrace groups and free standing buildings of similar age and character.
- 09 To ensure the structural integrity of individual buildings and groups.
- 010 To retain and conserve external original fabric and features characteristic to a traditional terrace semi-detached dwellings or dwelling house.
- 011 To retain and conserve internal significant original fabric and features characteristic to a traditional terrace house.
- 012 To retain the historic framework of the building both as essential structure and as evidence of original patterns of construction and use.
- 013 To provide protection for potential heritage artefacts.

---

## Controls

### *Principal building form*

#### *Exterior controls*

- C1 The significant external elements of a principal building form are to be retained and conserved, that is:
- a) significant external fabric is to be retained and conserved;
  - b) characteristic elements such as roof pitches, eave heights and chimneys are to be retained and conserved;
  - c) no external alterations or additions are to be made to the significant elevations, details, materials or finishes of the principal building form except to allow for restoration or reconstruction;
  - d) the main rear wall to the principal building form should be left largely intact; and
  - e) significant verandahs and balconies are not to be infilled or enclosed.
- C2 When works are proposed to the principal building form or original significant elevations visible from the street, Council encourages, and may require, reconstruction or restoration of missing elements (where physical or documentary evidence of an earlier state exists) or reversal of uncharacteristic elements where:
- a) original render has been stripped from an external wall surface;
  - q) balconies or verandahs have been enclosed and details such as balustrade panels, rails, columns, friezes and fringes have been removed;
  - r) original door or window types and patterns have been removed;
  - s) roof cladding is in a unsympathetic material;
  - t) details are missing from chimneys; and
  - u) inappropriate reconstruction of period detail and elements has occurred.
- C3 Where a building forms part of a group, any work to the principal building form must be designed to retain the contribution and relationship of that building to the other buildings or building which comprise the group.
- C4 Where the building contains an existing basement level at the street front, no alterations or additions are to be made to the street front basement elevation or external staircase, except for the purposes of restoration or reconstruction of missing elements.
- C5 Where structural stabilisation is required, a sympathetic structural solution that retains original external fabric is required.
- C6 Where alterations are required to meet the Building Code of Australia, materials must be consistent with traditional material and finishes.

*Interior controls*

- C7 The significant original internal elements of the principal building form, in particular distinctive joinery, fireplaces and decorative plasterwork, are generally to be retained.
- C8 New openings in internal walls and floors and ceiling structures lateral to party walls must retain the structural integrity of the building and its neighbours, and should retain the significant original ceilings and cornices. Interpretation of original wall positions and room proportions should be provided. The revised structure may incorporate suitable portal frames.
- C9 Where structural stabilisation is required, a sympathetic structural solution that retains original internal fabric is required.

*Street front zone*

- C10 The location, form and materials of original stairs must be retained. Risers and treads may be reconfigured to conform with BCA requirements.
- C11 All original windows and doors including those to basement levels are to be retained.
- C12 Non-original doors and windows shall be reconfigured to a traditional type consistent with the architectural style of the building and, where evidence exists of the original doors and windows, they are to be replicated.
- C13 Original fences that have been replaced by intrusive fences should be replaced.
- C14 When works are proposed in the street front zone Council encourages, and may require reconstruction or restoration of missing elements or reversal of uncharacteristic elements.
- C15 Where a building forms part of a group, any work in the street front zone must be designed to retain the contribution and relationship of that building to the other buildings or building which comprise the group.

---

## C1.4.2 Side elevations and side additions

---

Side elevations or secondary elevations are less detailed than the main street front elevations. Side elevations of Victorian terrace houses are often built to the street boundary with a strong gabled form reflecting the pitch of the main roof and a lower skillion section at the rear.

Due to the high visibility from streets and laneways, changes to side elevations and additions require an approach that retains the architectural form and character of the building.

Some sites have the opportunity to develop additions to the sides or adjacent to the principal building form between a row of buildings. Where these are on the same registered land parcel, and where they do not affect 'night soil' or right of way passageways, they may be developed in accordance with the following provisions below. Significant 'night soil' or right of way passageways are to be retained in place and interpreted without additional structures other than fencing.

Note: Side elevations are to a street or lane, whilst side additions adjoin other buildings.

Refer also to corner terrace style houses in Section 1.3.3 Corner buildings and other relevant sections in C1.3 Building types.

### Objectives

- 01 To retain and conserve the architectural character of side elevations of contributory buildings.
- 02 To ensure that side additions are of sympathetic design and construction to the original building.
- 03 To ensure that side additions to existing buildings are designed and located to achieve a cohesive relationship between the existing buildings, and retain and enhance the significance of the heritage conservation area.
- 04 To ensure that side additions respect the scale and setting of adjacent contributory buildings.
- 05 To protect the amenity of adjoining or adjacent residential uses.

### Controls

#### *Side elevations - street and lane*

- C1 Original side elevations of contributory buildings including original fabric, side entrance doors, windows, balconies and other details are to be retained and conserved.
- C2 Minor alterations to a side elevation of the principal building form or the secondary wing will be permitted if they do not impact on the architectural form and character.
- C3 Changes to the roof pitch of the principal building form of contributory buildings are not permitted.

*Side additions - street and lane*

- C4 Additions must be consistent with traditional patterns and proportions of openings and the materials and detailing of the existing building.
- C5 The overall length of any addition is to be less than, and appear as a form secondary to, the existing building.
- C6 The addition of balconies is not permitted when the building is built to the side street boundary.
- C7 Additions must retain the profile of existing traditional party walls and their associated parapets.
- C8 Additions shall reflect the existing setbacks.
- C9 Where there is a uniform building front setback, the side addition must be set back behind the front wall of the principal building form (not including the balcony) to which it is attached and adjoining buildings.
- C10 Where building front setbacks vary, the side addition must be set back behind the front wall of the principal building form (not including the balcony) to which it is attached.
- C11 Side boundary fencing shall reference traditional height, forms and materials.

*Side additions between buildings*

- C12 Side additions must:
  - a) maintain the significant features and qualities that combine to represent the character of the neighbourhood and area;
  - b) make a positive contribution to the character of the neighbourhood and area; and
  - c) maintain a contextual relationship between the existing building to which it is attached, the adjoining buildings and the streetscape in which it will be located by maintaining the development pattern.
- C13 Side additions must not overwhelm the context and should be subservient to and consistent with the predominant scale of the building to which it is attached, significant development adjoining the site and in the group/row in terms of:
  - a) maximum height pattern (measured to below the gutter line of the principal building form to which it is attached [or the base of the parapet where existing], not including chimneys); and
  - b) massing (building volume and size).
- C14 Side additions must be consistent with the predominant built form (volume and configuration) of the building to which it is attached and significant development adjoining the site and in its immediate area in terms of aspects including, but not limited to:
  - a) roof forms and pitch;

- 
- b) three dimensional modelling of neighbouring buildings;
  - c) modulation and articulation;
  - d) relationship of solids and voids;
  - e) fenestration patterns; and
  - f) relationship of floor to ceiling heights and horizontal alignment of features (especially ground and first floor levels of the existing buildings to which it is attached).

Refer also to Section 1.4.4 Roofs and roof forms, Section 1.4.5 Building height, bulk, form and scale, and Section 1.4.6 Site coverage, setbacks and levels.

- C15 Side additions must adopt the established orientation pattern of the existing building to which it is attached.
- C16 Where there is a uniform building front setback, the side addition must be set back behind the front wall of the principal building form (not including the balcony) to which it is attached and adjoining buildings.
- C17 Where building front setbacks vary, the side addition must be set back behind the front wall of the principal building form (not including the balcony) to which it is attached.
- C18 If the side addition occurs on a corner site, the controls in C1.4.2 apply.
- C19 Rear and side setbacks (including side passages) must align with existing patterns, where visible from the public domain.
- C20 Side additions must be sited to:
  - a) include sufficient deep soil landscaped area; and
  - b) have no adverse impact on significant trees on the site or adjoining land, including public land.

Refer also to Section 1.4.8 Private open space, swimming pools, courtyards and landscaping.

- C21 Materials, finishes, textures and colours must be appropriate to the historic context. They must be similar to the characteristic materials, finishes, textures and colours of the existing building to which it is attached and existing contributory buildings within the streetscape.
  - C22 Contemporary materials are permitted where their proportions, detailing, quantities and location on the building are in keeping with the character elements (refer to C1.2.3) and the desired future character of the heritage conservation area (refer to C1.2.4).

Refer also to Section 1.5.8 Materials, finishes and details and Section 1.5.9 Exterior colours.
  - C23 Side additions must:
    - a) use render, masonry and/or timber;
-

- b) avoid large expanses of glass and reflective wall cladding;
- c) if visible from the street or public domain, use roof cladding which matches the existing building to which it is attached;
- d) not have solid masonry front boundary walls; and
- e) use colour schemes which respect the character of the neighbourhood.

**Note:**

For side additions between buildings, a draft site and context analysis is to be submitted to Council for comment as part of a predevelopment application meeting between Council representatives and the applicant.

The following information is to be submitted for comment prior to the lodgement of the development application:

- ▶ design options explored and the applicant's preferred design proposal;
- ▶ a statement outlining the proposed measures to minimise the adverse impact of the side addition on neighbouring lands, including the public domain;
- ▶ the philosophy of how the design elements relate to the proposal's context in terms of architectural form, materials and character; and
- ▶ the historic context and impact sections of a draft statement of heritage impact.

For development applications, applicants are required to provide the following information, not limited to:

- ▶ design options and final preferred design;
- ▶ a detailed site and context analysis;
- ▶ profiles of adjoining development;
- ▶ RLs for the subject site and adjoining properties;
- ▶ an accurate survey (including RLs, and the accurate location of eaves/gutters, chimneys and other structures on adjoining properties);
- ▶ the structural relationship with the existing building and any adjoining properties (including shared party walls, footings and chimneys); and
- ▶ the final version of the statement of heritage impact.

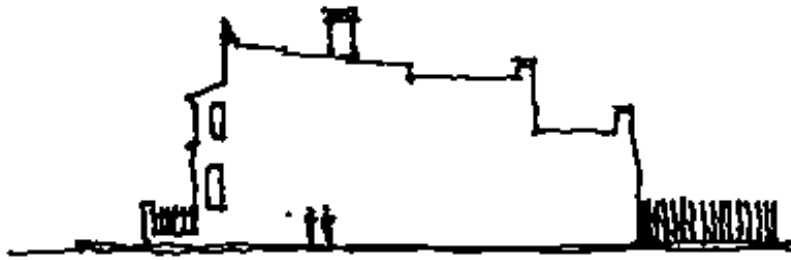
Other required documentation to be submitted with the development application can be found in the Development Application Guide.

**FIGURE 7** Side elevations



There is a variety of shapes and forms, but the general treatment of visible side elevations is simpler than the front elevations.

Ornamentation is rare and in the expanse of walls, fenestration is limited.





---

### C1.4.3 Rear elevations, rear additions, significant outbuildings and yards

---

There is a distinct visual contrast between the front and the rear of houses.

In a typical Victorian terrace, the highly decorative front contrasts with the restrained and utilitarian finish at the rear. Traditional rear additions are smaller in scale than the main house, with simple forms punctuated with vertically proportioned window openings. The rear of the Victorian style double storey terrace is often characterised by a one or two storey structure, commonly under a single pitched or skillion roof which maintains a side breezeway. The simple pitched or skillion roof form on rear elevations is visible, unlike the front elevation roof which may be screened by a parapet. Street corner buildings sometimes employ a parapet to both front and side elevations. Frequently rear elevations are paired with a neighbouring property.

There is a distinct typology of rear building forms within Paddington. Due to the elevated siting and topography of Paddington, many rear forms of buildings are highly visible.

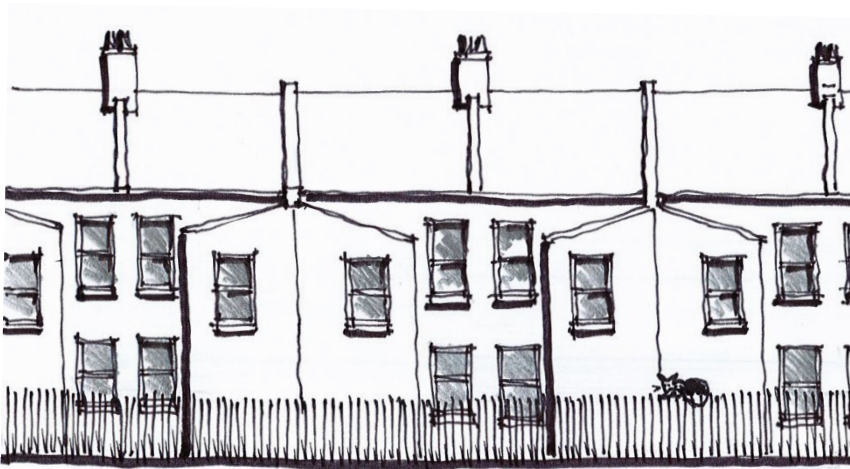
Some rear building forms survive in unaltered groups of houses and contribute significantly to the character of the heritage conservation area.

An unaltered group is defined as a building or group of buildings that has retained its original form and character, there may be some minor changes to windows and doors or the loss of some original detail, but notwithstanding the original form and character of the group is generally retained.

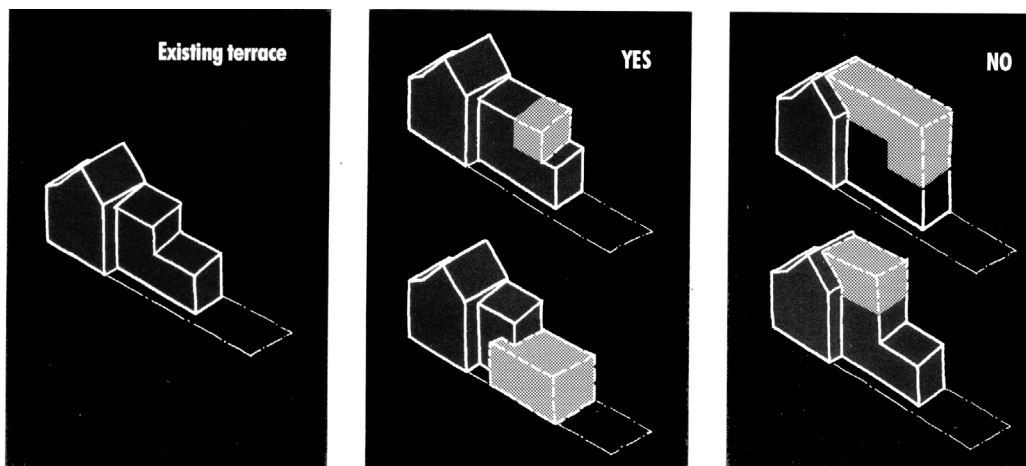
Traditionally the rear yard of 19th century housing was utilitarian in use and character, usually enclosed by a paling fence with a gate leading to a laneway. Many groups of houses such as terrace houses had a rear passageway for servicing outdoor rear yard brick toilet structures. The remaining 'night soil passageways' and rear yard outdoor toilet structures are a significant element in Paddington. Remnant stable structures are rare.

#### Objectives

- 01 To retain the forms and character of traditional rear elevations of contributory buildings, particularly where they exist in unaltered groups.
- 02 To ensure that rear alterations and additions are of sympathetic design and construction.
- 03 To ensure that the distinctive shared characteristics of groups of contributory buildings are retained and enhanced.
- 04 To enable sympathetic contemporary design and use of contemporary materials in appropriate circumstances.
- 05 To ensure that significant outbuildings are retained and conserved.

**FIGURE 8** Rear elevations

Where a coherent group of rear elevations exist, any development should occur within the existing envelopes. New development which ignores its context will not be permitted.

**FIGURE 9** Rear additions

Rear extensions should respect the traditional hierarchy of scale and form. Greater freedom is permitted of the architectural treatment of ground floor extensions than for visible upper floor additions.

## Controls

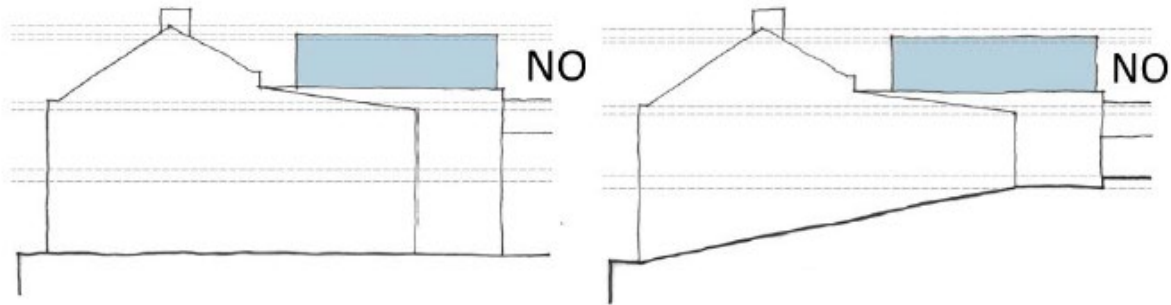
### *Rear additions*

- C1 Alterations and additions to a building which comprises one of a group, or pair, must be designed with regard to the overall balance of the group, or pair, in terms of height, alignment, form, scale, breezeway pattern and architectural character and detail.
- C2 The roof of an extension or the new roof for an existing component must be of traditional form appropriate to the building type.
- C3 Roofs must be visible and not screened partly or wholly by features such as parapets. The exception may be corner sites. Parapet roof forms may only be considered appropriate

where it can be demonstrated that a parapet form is consistent with the bulk, scale and character of the existing building and group.

- C4 No part of a rear alteration and addition can be higher than the gutter line of the principal building form (chimney excluded).

**FIGURE 9A** Intrusive development: rear additions showing additional levels above the gutter line which are not supported by C5. The difference between the two drawings is the topography of the site.



- C5 Alterations and additions at the rear of buildings must:
- a) not dominate or otherwise adversely compete with the form, height, proportions and the scale of that part of the building which is to be retained;
  - b) not reproduce or match a building which in terms of its height, bulk, scale and detailing is inappropriate to the heritage character of the area;
  - c) retain traditional solid to void ratios on elevations visible from the public domain;
  - d) not employ large areas of glass on upper levels;
  - e) be designed to minimise or avoid an adverse impact on neighbouring properties in terms of overlooking, loss of sunlight and ventilation;
  - f) not extend beyond the predominant rear building setbacks at any level of a group or row of buildings; and
  - g) retain all original chimneys.
- C6 Building boundary to boundary on the ground floor level is permissible provided that:
- a) the development does not adversely affect the privacy, ventilation, light and the amenity of the adjoining properties; and
  - b) the development does not disrupt an existing pattern of a group of unaltered contributory buildings.
- C7 Additions are not permitted where single or double storey rear skillion forms exist in an unaltered group. In such cases alterations are to occur within the existing building envelope.
- C8 Where significant original decorative internal elements exist outside of the principal building form they are generally to be retained.

*Unaltered groups*

- C9 Unaltered groups with single storey rear wings must retain their single storey form. Single storey, courtyard housing style additions with attic rooms may be permitted, where the addition does not result in view loss of the main wing from the public domain.

*Contemporary design*

- C10 Sympathetic contemporary design may be permitted at the rear where:
- a) intrusive fabric or fabric of low significance exists;
  - b) the proposal will achieve an aesthetically cohesive relationship between new and existing fabric; and
  - c) the proposal is consistent with the character of the site, the streetscape and the precinct in which it is contained.

*Significant structures and areas at the rear*

- C11 If development is in the form of a dual occupancy, the additional controls for dual occupancies in Part B, Chapter B3 General Development Controls of this DCP also apply (refer to Section B3.8 Additional controls for development other than dwelling houses) .
- C12 Significant backyard toilet structures on rear laneways are to be retained in place if they are one of a group of at least two adjacent original toilets.
- C13 Significant 'night soil' passageways are to be retained in place and interpreted without additional structures other than fencing.
- C14 Significant ancillary structures including stables, coach houses and wells in the rear yard are to be retained in place.

---

### C1.4.4 Roofs and roof forms

---

Main roof forms vary with building types and architectural styles. Cottages have hipped or gable roof forms, or a combination of the two. In terrace housing there are two predominant roof forms. Some roofs are pitched both ways from a central ridge. This is often articulated by the projecting gabled party walls. Corner terraces have segmented hipped forms which address the corner site or composite roofs concealed behind a parapet. Less common is the skillion roof form terrace with a parapet to the street front that steps down along the side elevation.

Below main roof forms there are verandah roofs. Some are stepped down from the main roof. They have distinct profiles and include convex or concave and skillion profiles depending on the architectural character of the building.

There are also secondary roof forms. Lower roofs to rear additions are generally skillion forms. When paired with a similar property, roofs produce patterns of gabled forms to the rear of properties. The simple pitched or skillion roof form on rear elevations is visible, unlike the front elevation roof which may be screened by a parapet.

The earliest roofs in the original Paddington village were covered in timber shingles. Later materials used throughout Paddington are slate, corrugated galvanised iron and zinc coated corrugated steel. Consistent with the style, roofs of Federation period buildings have the characteristic unglazed terracotta tiles.

Associated with the roof and the roofscape are a number of important elements such as traditional flashings, barge rolls, eaves and ridge detailing.

The arrangement of terraces stepping down the hills of Paddington affords views to the roofs. As a consequence, the roofscape is a significant element in the urban character of Paddington.

Replacement of original roofing materials with concrete tiles or glazed tiles, and the replacement of original roof details such as the covering over of lower verandah roof profiles are eroding Paddington's roofscape.

#### Objectives

- O1 To retain and conserve the character of the original roofscape of Paddington.
- O2 To restore or reconstruct missing roof elements.
- O3 To ensure that contemporary roof forms are consistent with the historic roofscape character of Paddington.
- O4 To ensure that the roof form and pitch of upper storey rear additions is consistent with the roof form and pitch of the existing group or pair.

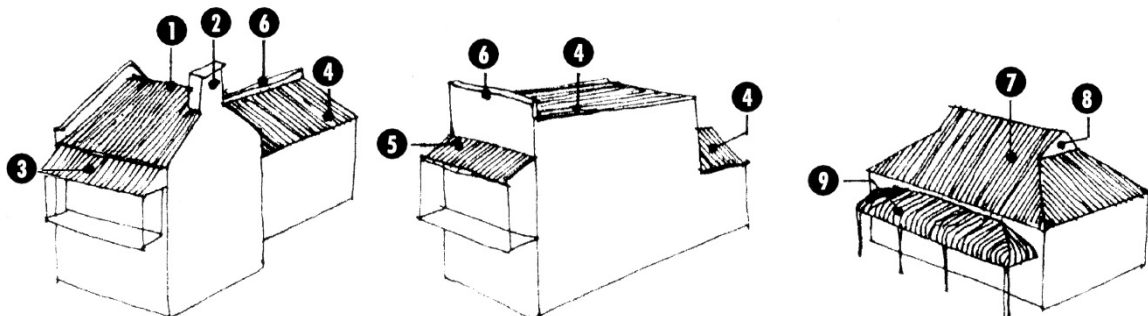
#### Controls

- C1 The removal of original roofing materials and their details is not permitted unless deteriorated materials are replaced by the same or similar materials and details.

- C2 Existing patterns of roof forms within groups of unaltered buildings must be retained.
- C3 The roofscape of the principal building form of contributory buildings is to be retained. The possible exceptions are:
- a) a dormer and skylight to the rear roof slope where permitted under Section 1.5.1 Dormers and skylights; and
  - b) a dormer to the front roof slope where permitted under Section 1.5.1 Dormers and skylights.
- C4 Missing roof elements must be reinstated when unsympathetic roofs are replaced.
- C5 Secondary or rear roof forms must not be raised or altered if the rear skillion forms part of a group of similar roof forms. The possible exception is a dormer and a skylight to the rear roof slope. Refer to Section 1.5.1 Dormers and skylights.
- C6 Roof forms are to be consistent with appropriate traditional roof forms, which reflect the diminishing scale of roofscapes towards the rear of buildings.
- C7 Reverse skillion roof forms are not permitted to contributory buildings.
- C8 Roofs are to be clad in materials with profiles that are appropriate to the architectural style of the building. Appropriate materials are described in Section 1.5.8 Materials, finishes and details.
- C9 Unsympathetic roofing materials must only be replaced by roof cladding in either traditional materials or in contemporary materials, which are similar in appearance and profile to traditional materials.
- C10 Rear roof planes are not to incorporate more than 25% transparent material. This includes the area of skylights and dormer windows.
- C11 New rear additions to multi-storey buildings must remain consistent with the group or pair in terms of roof form and roof pitch.

**FIGURE 10** Roof elements

- |                 |                         |                           |
|-----------------|-------------------------|---------------------------|
| 1 Gable roof    | 4 Skillion roof         | 7 Hipped roof             |
| 2 Chimney stack | 5 Skillion balcony roof | 8 Gablet                  |
| 3 Balcony roof  | 6 Parapet               | 9 Bullnosed verandah roof |



---

### C1.4.5 Building height, bulk, form and scale

---

Building heights in Paddington vary with the type of building but generally there is a predominance of two and three storeys. An important part of the character of a group of buildings can be its uniform height particularly when viewed from the street frontage.

Less prevalent in numbers are single storey terrace groups and individual single storey buildings. Many of these single storey buildings and groups are highly significant because of their rarity and because they represent a particular building type in the early historic development of the area.

The bulk, form and scale of buildings in Paddington are also important contributing elements to the character of the area generally and to the character and significance of groups of buildings.

The height bulk, form and scale of new development have the potential to adversely impact on the amenity of private and public lands.

#### Objectives

- 01 To retain the distinctive height, bulk, form and scale of particular building types.
- 02 To retain the existing heights of single storey buildings.
- 03 To maintain the visual consistency of established heights in historically significant streetscapes.
- 04 To ensure that the height of new development conforms to the appropriate heights in the street or lane and the historic character of the street or lane.
- 05 To minimise the impact of new development on the access to sunlight for private properties and public places such as neighbourhood parks.
- 06 To protect the amenity of adjoining or adjacent residential uses.

#### Controls

- C1 The height of existing buildings on street frontages must not be increased.
- C2 Upper floor additions to significant single storey buildings, which will result in an increased building height, are not permitted. This will apply irrespective of whether the single storey building adjoins or is located between higher buildings.
- C3 The height, bulk, form and scale of infill and new development must be consistent with the predominant height, bulk, form and scale of appropriate adjoining buildings. Conformity with adjoining buildings is not appropriate in circumstances where the development site adjoins a building which is a substantially taller landmark building, or is a building considered to be intrusive due to its excessive height and incompatible design.
- C4 Infill development and alterations and additions must be designed and sited so that sunlight is provided to at least 50% or 35m<sup>2</sup> with minimum dimensions of 2.5m, whichever is the lesser, of the main ground level private open space of adjoining properties for a

minimum of two hours between 9am and 3pm on 21 June. Where existing overshadowing is greater than this, sunlight is not to be further reduced.

- C5 Where adjoining dwellings have greater than three hours of sunlight to a habitable room, the north facing windows to the habitable room are not to have sunlight reduced to less than three hours between 9am and 3pm on 21 June.
- C6 New dwelling houses are to have at least one habitable room with windows which receive at least three hours of sun over a portion of their surface between 9am and 3pm on 21 June.
- C7 Storey heights must conform to those of appropriate adjacent buildings.



---

### C1.4.6 Site coverage, setbacks and levels

---

Paddington is notable for a predominant pattern of repetitive terrace building types on long rectangular blocks running between streets and laneways.

The prevalent street alignment is close to the street. Setbacks from street boundaries vary overall from nil to setbacks that allow the establishment of large gardens.

Within rows of buildings there are varied front and rear alignments depending on whether the building is one of a group of similar buildings, a pair or an individual building. Occasionally a building is a one-off building located on a corner site.

Terraces with east-west orientation step down reflecting the topography of the hills. Terraces with north-south orientation sometimes incorporate a basement level taking up the fall of the site.

Terraces were a speculative building type where the group of terraces usually relies on the structural integrity of the group. The footings to a row of terraces may be considered minimal by current building standards and subfloor drainage poor. Structural and groundwater alterations to one terrace may have an adverse impact on others in the area.

#### Objectives

- 01 To maintain setbacks along the street frontage.
- 02 To retain established building alignments, setbacks and levels.
- 03 To ensure that new development continues the established alignments and setbacks of the established historic development in the streetscape.
- 04 To ensure that the siting of new development responds appropriately to levels established by relevant historic development in the streetscape.
- 05 To retain and protect front yards and their significant fabric.
- 06 To encourage the retention or creation of useable open space at the rear of sites.

#### Controls

##### *Site cover*

- C1 The proportion of building footprint is to be consistent with similar properties in the immediate vicinity.

##### *Setbacks*

- C2 Existing setbacks on street frontages are to be maintained.
  - C3 Siting and setbacks of all structures are to continue the immediate established patterns.
-

- C4 New development outside a commercial area is not to be built forward of existing building alignments.
- C5 The existing siting pattern within the commercial area is to be maintained.
- C6 Additions at the rear of buildings in the commercial areas must not extend beyond the rear setbacks of adjacent contributory buildings. In such cases, balconies may project beyond the rear setback.

*Levels*

- C7 New development is to be consistent with ground and first floor levels established by existing buildings and topography in the context of a sloping site.

---

### C1.4.7 Excavation

---

The geology of the Paddington area varies from sandstone, loose sandy soils or a combination of sandy soils overlaying a sandstone stratum. Other foundation materials are very rare and less problematic than the worst case of sand over rock.

There are some site typologies where excavation for the purposes of establishing a basement may be considered reasonable. However, it should be recognised that the majority of the site typologies in Paddington do not lend themselves to excavation. The objectives and controls in this section are informed by an understanding of the methods involved, and potential impact, of excavating certain foundation types.

The majority of the common walls between terrace style housing in Paddington are constructed of sandstock bricks and lime mortar on brick footings or on sandstone blocks. The density of development in Paddington has resulted in many buildings, primarily groups of terrace row style housing, with a shared structural system of footings, common party walls and lateral cross walls. These walls are interconnected and interdependent brick walls set over a number of properties.

Excavation together with alteration of these footing systems can have detrimental effects on an individual property and also impact on neighbouring properties within a terrace group. The original footings and walls, built to differing standards, cannot tolerate any foundation movement without cracking and sometimes structural failure. Council's records provide evidence that excavation works under and near common wall footings have caused damage to the significant original fabric of many buildings in Paddington.

The objectives and controls below apply to any excavation proposed under the principal building form (refer to Section 1.4.1 Figure 6), secondary wing, or any other location on a property. The controls require an understanding of the subsurface conditions, and seek to protect the structural integrity of the individual building, the row of houses of which it is a part, adjoining properties, and their heritage significance.

Excavation is controlled in order to preserve the heritage fabric and structural integrity of buildings that collectively contribute to the significance of Paddington.

Excavation and below ground construction can also impact on natural groundwater flows, resulting in potential damage to buildings. Most masonry terrace houses and Victorian cottages do not have cavity walls or damp proof courses, which may result in rising damp and the potential for mould internally. Maintaining subfloor ventilation is an important part of controlling damp for it allows soil moisture to evaporate beneath the floors and to pass out through the air vents in the walls.

Replacing a timber floor with an on-ground concrete slab within a building without damp proof courses will usually direct the soil moisture towards the walls, creating a rising damp problem. Changing the natural groundwater pattern other than by controlling the direction of groundwater by through-site systems may result in a 'damming effect', which may result in rising damp problems.

The objectives and controls contained in this part have adopted the principle of precautionary behaviour, one of several principles that form the basis of ecologically sustainable development.

**Note:**

The following information must be submitted with the development application:

- ▶ A geotechnical report that identifies surface and substratum conditions and survey levels of original footings and walls. The report must be prepared in accordance with Council's guidelines.
- ▶ A structural report that cross-references the geotechnical report and identifies the structural systems to be employed to maintain structural integrity.
- ▶ Construction details for any new wall in the vicinity of any original external wall. Surveyed levels of the original building fabric are to be included.

In granting a development consent, Council may impose a condition requiring the preparation and submission of pre-commencement and post-completion dilapidation reports for properties adjoining and neighbouring the development.

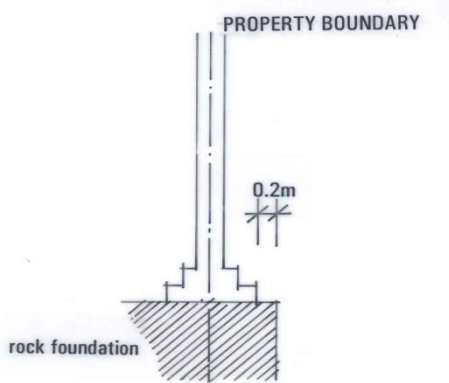
Applicants may also require consent under the *Heritage Act 1977* or the *National Parks and Wildlife Act 1974* for the excavation of land which is known or suspected to have archaeological potential.

**Objectives**

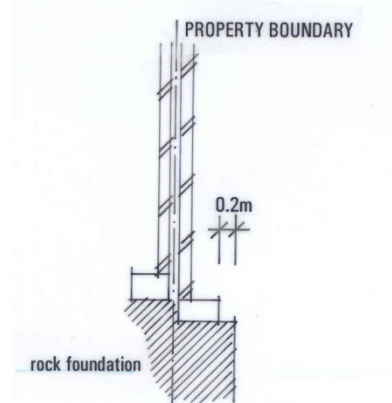
- 01 To ensure the structural integrity and stability of individual buildings and the terrace of buildings of which they are a part, and neighbouring properties.
- 02 To protect the original fabric of the buildings significant to the area both during and after excavation.
- 03 To ensure that objectives 01 and 02 are achieved by limiting the circumstances where excavation may occur.
- 04 To limit the impact of excavation on the natural landform and vegetation.
- 05 To relate development to the existing topography and existing ground levels.
- 06 To avoid potential damage to all buildings and structures during and after excavation.
- 07 To ensure that any new floor levels resulting from excavation and development do not compromise external heritage features of the building or those of its neighbours.
- 08 To ensure that habitable rooms created by excavation are supplied with adequate natural light and ventilation in order to meet sustainable building principles.
- 09 To maintain natural subsurface ground water flows.
- 010 To recognise the protection necessary for potential archaeological objects.

FIGURE 11 Guidelines for excavation

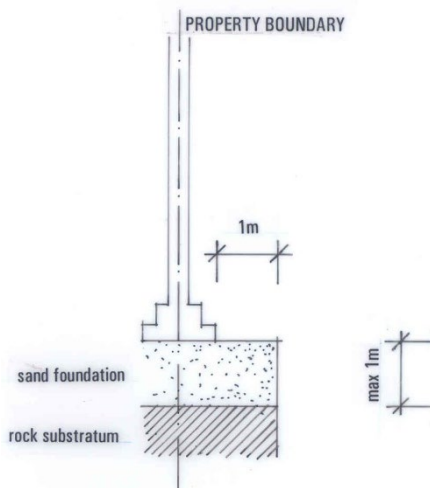
Common party wall



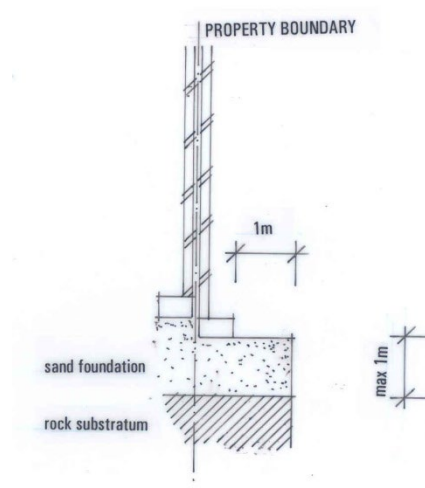
Freestanding boundary wall



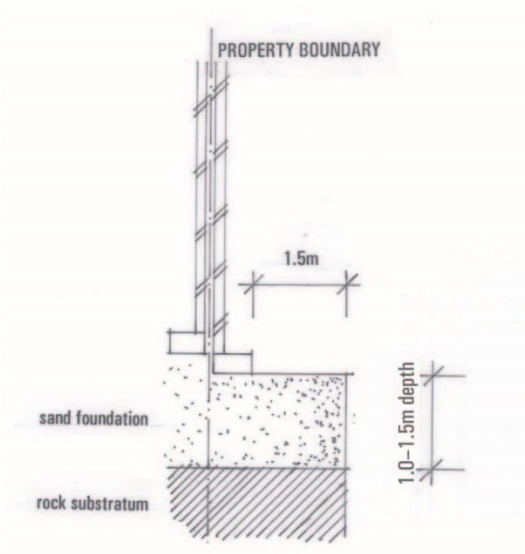
Common party wall



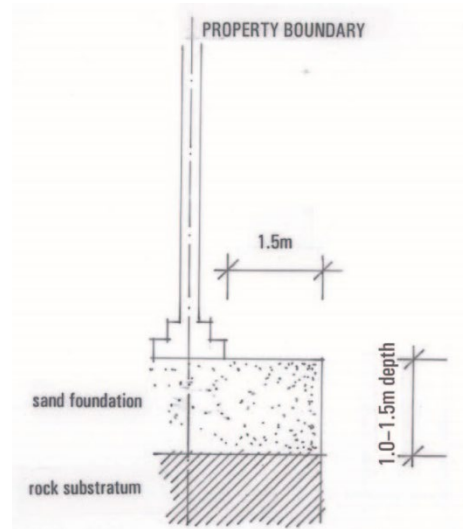
Freestanding boundary wall



Common party wall



Freestanding boundary wall



---

## Controls

### General

- C1 Excavation will not be permitted if:
- a) it will occur under common walls and footings to common walls, or freestanding boundary walls, or under any other part of adjoining land; and
  - b) it will occur under or forward of the front façade; and
  - c) the outer edge of the excavation is within 0.2m of the footings of the front wall, party walls, or freestanding boundary walls, where the existing footing has bearing directly on rock foundation; or
  - d) the outer edge of the excavation is within 1m of the footing of the front walls, party walls, or freestanding boundary walls, where the existing footing has bearing on sand foundation or sandy soils up to 1m deep over a rock substratum; or
  - e) the outer edge of the excavation is within 1.5m of the footing of the front wall, party walls, or freestanding boundary walls, where the existing footing has bearing on sand foundation or sandy soils of a depth greater than 1m but not more than 1.5m over a rock substratum;
  - f) the rock substratum is greater than 1.5m below original footings; and
  - g) habitable rooms formed from the excavation:
    - do not have at least one external wall fully above existing ground level; and
    - will not receive adequate natural light and ventilation; and
  - h) a geotechnical and structural report cannot ensure that the works will not have any adverse effect on the neighbouring structures. The report must be prepared in accordance with the Council’s publication ‘Guide for preparing Geotechnical and Hydrogeological Reports’;
  - i) the removal of the existing floor structure above the excavation is required in order to carry out the excavation other than the temporary, partial removal of floor boards to allow exploratory investigation of subsurface conditions.

Note: The above diagrams are not definitions but are provided to assist with interpretation of the controls. Front façade includes the outer edge of balconies and verandahs.

- C2 In order to prevent damp problems for the subject building or any neighbouring properties, all buildings that do not have damp proof courses within their party walls, must have timber floor at the lowest floor level.
- C3 For a subsurface structure, an effective groundwater drainage system must be incorporated within the design. This will not be required in cases where the applicant demonstrates through a hydrogeological report that:

- a) the works will not affect groundwater flows; and
  - b) the proposed development will not have an adverse impact on the existing moisture level of an original external wall of an adjoining building which contributes to the significance of Paddington, especially those without existing damp proof courses.
- C4 The ground and first floor levels of alterations and additions and infill development are to be consistent with the levels established by existing buildings and topography on adjoining sites.
- C5 Despite C1, minor excavation may be allowed in the following cases:
- a) maintenance or replacement of existing footings and subfloor walls;
  - b) maintenance or repair of existing essential services or the introduction of new essential services.
- Note: Services include sewer and drainage.

*Excavation for garage structures*

- C6 Boundary to boundary excavation may be permitted for garage structures on rear laneways if:
- a) the structure complies with Section 1.5.6 On-site vehicle parking, garages, carports, driveway access and servicing facilities;
  - b) the structure does not adjoin the principal building form or secondary wing of a building constructed on the common boundary of an adjoining site; and
  - c) no original footings on adjoining sites will be disturbed.

*Excavation for other structures beyond the principal building form or secondary wing*

- C7 Excavation may be permitted for structures such as pools, spas, or other permissible development if:
- a) for properties less than 6m in width, the outer edge of excavation is setback from side boundaries by at least 900mm;
  - b) for properties 6m or more in width, the outer edge of excavation is setback from side boundaries by at least 1.5m;
  - c) the lowest habitable room, if any, of the proposed development has at least one external wall fully above the existing ground level;
  - d) no original footings on an adjoining property will be disturbed; and
  - e) a geotechnical report ensures that works will not have any adverse effect on the neighbouring structures. The report must be prepared in accordance with Council's guidelines.

---

### C1.4.8 Private open space, swimming pools, courtyards and landscaping

---

Paddington's characteristically small lots with boundary to boundary buildings provide limited opportunities for ground level open space and landscaped areas.

In many instances with residential properties, a small landscaped area occurs in the street front zone. This area creates an open appearance and provides visibility to and from the street, both of which are important to the setting of each building and to the streetscape. There is greater scope for useable private open space and landscaping at existing ground level at the rear of residential properties, and Council requires that the principal area of private open space is located at the rear.

For residential flat buildings and manor houses, including those built as infill development or those which adapt existing buildings, open space may be provided as private and communal areas. In these buildings private open space may be provided at ground or above ground level. The latter may comprise balconies and verandahs.

Roof terraces are not characteristic of Paddington and are not generally acceptable as private or communal open space. Further, because of the dense built character and sloping landform of Paddington, use of roof terraces can produce detrimental impacts on privacy due to overlooking and noise transmission.

The amount and composition of landscaped open space play important roles in stormwater management, energy efficiency of developments and access to sunlight. Trees and vegetation can support indigenous wildlife populations and habitat.

Deep soil landscaped area is an important element of the overall landscape capabilities on a site. To be effective, deep soil landscaped area needs to be a suitable size, configuration and location to sustain medium to large vegetation. This means there needs to be adequate width and depth of soil profile for root volumes and long term stability of vegetation.

Refer to Section 1.5.10 Gardens and trees for specific objectives and controls for gardens and trees.

#### Objectives

- 01 To maintain open areas at the front of buildings and their visibility from the street.
- 02 To retain and reinstate traditional landscaping and open areas at the front of buildings.
- 03 To maintain an area at the rear of each site which enables planting at natural ground level and assists on-site drainage.
- 04 To ensure that provision is made for accessible and useable private open space at the rear of properties.
- 05 To ensure the provision of semi-permeable and permeable areas of open space in rear gardens to assist with on-site drainage.



- 
- O6 To ensure that the design and use of private open space areas has regard to environmental impact, impact on the fabric of adjoining properties, infrastructure, and on the amenity of the occupiers of adjoining properties.
  - O7 To ensure that trees and other vegetation do not have an adverse impact on the fabric of buildings, and that works have no or minimal adverse impact on the amenity of the occupiers of properties.
  - O8 To ensure adequate and reasonable acoustic and visual privacy for neighbours.
  - O9 To ensure provision of adequate deep soil landscaped area capable of sustaining medium to large vegetation.

## Controls

### *Open and unbuilt upon area and deep soil landscaped area*

- C1 The open and unbuilt upon area within the street front zone must be retained and is to remain visible from the street.
- C2 Traditional landscaped and open areas in the street front zone are to be retained.
- C3 The design of new open space areas in the street front zone must use features and materials that are appropriately scaled and consistent with the architectural character of the building and the group, where the building forms part of a group.
- C4 A dwelling that is a dwelling house, dual occupancy, semi-detached dwelling or an attached dwelling is to provide the following: an unbuilt upon area including a principal open space area to be located at the rear, and deep soil landscaped area in accordance with Table 2.
- C5 A new residential flat building, manor house, multi dwelling housing (terraces) or multi dwelling housing, or the adaptive reuse of a building as a residential flat building, manor house, multi dwelling housing (terraces) or multi dwelling housing is to be provided with private open space, unbuilt upon area and deep soil landscaped area in accordance with Table 3, except where compliance would require demolition of significant structures.
- C6 Each new dwelling within a mixed use development is to be provided with private open space and deep soil landscaped area in accordance with Table 3.
- C7 Deep soil landscaped area must be in a location and have an adequate soil profile depth to allow for root volumes and the long term stability and health of vegetation.
- C8 Appropriate vegetation types are to be planted in the deep soil landscaped areas having regard to the dimensions of the area and the nature of subsurface soil and rock profiles.  
Note: Advice from an arborist/horticulturist is recommended.
- C9 Part of the private open space must be capable of serving as an extension of the dwelling for relaxation, dining, entertainment, recreation and children’s play area and should be directly accessible from the main living area of the dwelling.

- C10 Stairways and ramps may be used to provide access from the building to the open space in cases of sloping sites and grade variations.
- C11 The raising of open space areas to provide level access from a building is not permitted if there would be an adverse impact on adjoining properties and the significance of the property generally.
- C12 Private and communal space is generally not permitted in the form of a roof terrace.

**TABLE 3** Minimum unbuilt upon area and deep soil landscaped area requirements for a dwelling that is: a dwelling house, dual occupancy, semi-detached dwelling or an attached dwelling

Lot size	Minimum unbuilt upon area for each dwelling	Minimum deep soil landscaped area for each dwelling
Up to and including 100m <sup>2</sup>	▶ 10% of site area	5m <sup>2</sup>
More than 100m <sup>2</sup> and less than 180m <sup>2</sup>	<ul style="list-style-type: none"> <li>▶ 16% of site area</li> <li>▶ Principal rear area—minimum area of 15m<sup>2</sup></li> <li>▶ Principal rear area to have a minimum dimension of 3m</li> </ul>	8% of site area
180m <sup>2</sup> and above	<ul style="list-style-type: none"> <li>▶ 18% of site area</li> <li>▶ Principal rear area—minimum area 35m<sup>2</sup></li> <li>▶ Principal rear area to have a minimum dimension of 3m</li> </ul>	12% of site area

Note: The unbuilt upon area includes areas such as the deep soil landscape area, courtyards, unroofed swimming pools or tennis courts and the like. Uncovered parking areas and driveways are not to be calculated as unbuilt upon area.

**TABLE 4** Minimum private open space, unbuilt upon area and deep soil landscaped area requirements for residential flat buildings, manor houses, multi dwelling housing (terraces), multi dwelling housing and mixed use developments

Residential type	Minimum unbuilt upon area	Minimum deep soil landscaped area required	Minimum private open space required for each dwelling
<b>New development</b>			
Residential flat building, manor house, multi dwelling housing (terraces) or multi dwelling housing	40% of site area	20% of site area	(See below for dwellings)
Each new dwelling within the development	N/A	N/A	<ul style="list-style-type: none"> <li>► Minimum area of 8m<sup>2</sup></li> <li>► Minimum dimension of 2m in the form of a courtyard, balcony or verandah</li> </ul>
<b>Adaptive re-use of an existing building</b>			
Adaptive re-use of a building for a residential flat building, manor house, multi dwelling housing (terraces) or multi dwelling housing	N/A	<ul style="list-style-type: none"> <li>► 8% of site area where site less than 180m<sup>2</sup></li> <li>► 12% of site area where site is at least 180m<sup>2</sup></li> </ul>	(See below for dwellings)
Each new dwelling within the development	N/A	N/A	<ul style="list-style-type: none"> <li>► Minimum area of 8m<sup>2</sup></li> <li>► Minimum dimension of 2m in the form of a courtyard, balcony or verandah</li> </ul>
<b>Mixed use development</b>			
Mixed use development	N/A	<ul style="list-style-type: none"> <li>► 8% of site area where site less than 180m<sup>2</sup></li> <li>► 12% of site area where site is at least 180m<sup>2</sup></li> </ul>	(See below for dwellings)
Each new dwelling within the mixed use development	N/A	N/A	<ul style="list-style-type: none"> <li>► Minimum area of 8m<sup>2</sup></li> <li>► Minimum dimension of 2m in the form of a courtyard or verandah</li> </ul>

---

Note: The unbuilt upon area includes areas such as the deep soil landscaped area, courtyards, unroofed swimming pools, or tennis courts located at or near ground level, and the like. Uncovered parking areas and driveways are not to be calculated as unbuilt upon area.

#### *Swimming pools and spa pools*

- C13 Pools are to be located at the rear of properties.
- C14 For corner lots, and where the property has two street or lane frontages, pools are not to be located in the primary frontage (that is, they may be located in the secondary frontage).
- C15 Pools must not have an adverse impact on the fabric of adjoining properties or an adverse impact on the amenity of the occupiers of adjoining properties in terms of noise from pool equipment, flood lighting and discharge of backwash.
- C16 Pools will not be permitted if:
- a) construction of the pool would result in the removal of a tree that is a prescribed tree;  
or
  - b) the deep soil landscaped area requirement cannot be satisfied.
- C17 Pool coping must be flush with or not higher than 300mm above the existing ground level and no portion of the pool casing is to be visible from the public domain or an adjoining property.

#### *Courtyards*

- C18 Courtyards and lightwells must have an adequate system of stormwater drainage to avoid flooding of the property and adjoining properties in the event of one system being blocked, and to provide more efficient drainage when excessive stormwater occurs, such as double systems or long strip drainage.

#### *Landscaping*

- C19 Trees and shrubs at maturity should not have an adverse impact on the fabric of buildings, infrastructure, powerlines or other structures, and have only a minimal adverse impact on the amenity of the occupiers of properties.
- C20 Where prescribed trees are to be retained, structures are setback so they do not impact on the health of the tree.
- C21 Where possible, vegetation should be located to improve privacy between dwellings.
- C22 For infill development, trees are to be selected and located to contribute to energy efficiency and amenity by providing substantial shade in summer, especially to west facing windows, and by admitting sunlight to indoor and outdoor living areas in winter.
- C23 Landscaping must ensure the retention of adequate sight lines for pedestrians and vehicles, especially at street corners.

---

### C1.4.9 Views

---

Paddington’s sloping topography and the orientation of streets and subdivisions combine to offer panoramic and lesser views of the harbour, distant foreshores and city skyline from private properties and public areas. Views from private and public lands also take in the built landscape, including the stepped development pattern of terraces, roofscapes and winding streets.

Public views from streets, footpaths, parks and other public areas are among Paddington’s prized assets and are significant features of the area’s character. Protection of public views allows people to see and interpret the landscape and landmark features.

The height, bulk, form and scale of new developments have the potential to adversely impact on views gained from private and public lands. For private lands, the concept of view sharing is promoted. View sharing controls seek to strike a reasonable balance between new development and access to views from existing development.

Note: Refer to Section 1.6.2 Views and vistas for further information on views from public spaces and a map showing a selection of public views.

#### Objectives

- O1 To minimise the impact of new development on views from existing development.
- O2 To promote the concept of view sharing from private properties as a means of ensuring equitable access to views.
- O3 To protect and enhance views from streets and other public spaces.
- O4 To provide additional views from streets and other public spaces where opportunities arise.

#### Controls

- C1 New development must enable view sharing with surrounding development, particularly from main habitable rooms of that development.
- C2 Views from public open spaces to the harbour, foreshore areas and city skyline are to be preserved.
- C3 Location of new trees should enable views to be framed and protected when the trees reach maturity.

---

### C1.4.10 Acoustic and visual privacy

---

The predominant terrace building style in Paddington has resulted in a dense urban environment. Potential noise sources associated with more people living, working and recreating closer to each other often raises issues relating to acoustic and visual privacy.

Acoustic and visual privacy are major determinants of the ability of residents to enjoy their homes. Issues of acoustic and visual privacy are compounded in Paddington due to the historic mix of land uses, which may find retail, commercial and residential uses existing side by side.

The acoustic and visual privacy needs of residents should influence all aspects of design, including the location of new building works, building scale, the placement of windows, the location of main living rooms in a building, and the type of materials and construction techniques.

Various design solutions are possible for maintaining and improving acoustic and visual privacy. Solutions need to be considered having regard to matters such as the likely impact on heritage significance, the impact on bulk and scale, and the impact on the amenity of adjoining properties, including overshadowing.

Landscaping with vegetation is not considered to be an effective screening measure or a means of maintaining and improving privacy and is not a preferred solution. This is because it cannot be guaranteed that vegetation will be suitably and continually maintained by current and future owners, the long term health of vegetation is dependent on climatic conditions and the absence of disease, future building works can pose a threat to vegetation despite careful design, and effective vegetation screening often has to be of such a size and density which can create issues with proximity to buildings and structures and impact on light to living and recreation areas.

**Note:** An acoustic report prepared by a suitably qualified and experienced professional may be required as part of the site and context analysis process.

#### Objectives

- 01 To ensure an adequate degree of acoustic and visual privacy in building design.
- 02 To minimise the impact of new development on the acoustic and visual privacy of existing development on neighbouring lands.

#### Controls

- C1 Sound attenuation measures such as acoustic glazing and insulation are to be provided for new development close to high noise sources, such as busy roads and the Eastern Suburbs railway line.
- C2 In sensitive locations, such as where commercial, retail or other non-residential buildings adjoin or are adjacent to residential properties, or on busy roads, designs must meet the criteria for the Southern Sydney Regional Organisation of Councils Code for Road, Rail Noise Levels - External Noise Insulation Requirements for Multi Unit Residential Housing Against Road and Rail Noise.

- C3 Windows to bathrooms and toilet areas must have translucent glazing if they have a direct view to and from habitable rooms and private open space on adjoining and adjacent properties.
- C4 Direct overlooking of the main living areas and private open space areas of adjoining and adjacent properties should be minimised by the sensitive location of windows, balconies, and screening devices.
- C5 Rear and side balconies must not impact on:
  - a) the privacy and amenity of the building occupants; or
  - b) on the amenity of the occupants of adjoining and adjacent properties.
- C6 Privacy screens are to be designed with regard to the architectural style of the building and relevant aspects of the historic context.
- C7 Privacy screens must minimise view loss from other buildings and not unreasonably impact on solar access to neighbouring properties. (Refer to solar access requirements in Section 1.4.5. Building height, bulk, form and scale).

---

### C1.4.11 Land subdivision and site amalgamations

---

The distinct street pattern of Paddington arose out of the historic stages of the area's development. The earliest development on the western side of Paddington evolved as the Paddington village along cart tracks and is characterised by short angled narrow roads with closed vistas and dogleg junctions influenced by the boundaries of early land grants. Dense rows of cottages and terrace housing often have zero setbacks.

Later street patterns in the eastern half of Paddington were laid out in the Victorian boom period. The subdivisions are more strictly ordered with alternating wide streets and rear lanes (for night soil) and set out in the rectilinear grid. Development on corner sites is usually sensitive to the pivotal position they occupy in both streetscapes.

Generally there are narrow allotments with pairs, groups, and rows of housing which have similar setbacks and alignments. Within the allotments there are typical building footprints. In the commercial area, shops adjoin each other in terrace style arrangements. The buildings are aligned to the footpath edge.

Note:

- i) Woollahra LEP 2014 sets the minimum lot size for subdividing land.
- ii) Where a proposal for subdivision or site amalgamation involves the creation of a new lot or a number of lots and that lot or lots are capable of accommodating new buildings, the development application should be accompanied by at least a conceptual plan of the new buildings.

#### Objectives

- O1 To retain existing subdivision and building patterns.
- O2 To retain public lanes and public passageways which service Paddington's pedestrian network.
- O3 To ensure that subdivision or amalgamation of sites provides an appropriate response to the relevant historic character of Paddington and the relevant aspects of its historical pattern of development.

#### Controls

- C1 A proposed subdivision of an existing lot to create a new lot or an amalgamation of a number of lots must be of a size in area and dimensions which reflects the characteristics of historically relevant allotments adjoining and in the vicinity of the site.
- C2 Subdivision or site amalgamation must not compromise:
  - a) the significant features of the existing building on the site including outbuildings;
  - b) the setting of the existing site including significant fences and landscape elements; or
  - c) the setting of the building on adjoining sites.
- C3 Public lanes and public pedestrian passageways are not to be amalgamated with private land.



---

## C1.5 Specific policy for building and site elements

This section contains specific controls for building and site elements on residential and non-residential buildings, as relevant. The objectives and controls in this section apply to alterations and additions to existing buildings, and when constructing a new building.

The building and site elements addressed in this section are:

- ▶ 1.5.1 Dormers and skylights
- ▶ 1.5.2 Chimneys
- ▶ 1.5.3 Windows, doors, shutters and security
- ▶ 1.5.4 Verandahs and balconies
- ▶ 1.5.5 Fences, walls and gates
- ▶ 1.5.6 Onsite vehicle parking, garages, carports, driveway access and servicing facilities
- ▶ 1.5.7 Lofts over garages
- ▶ 1.5.8 Materials, finishes and details
- ▶ 1.5.9 Exterior colours
- ▶ 1.5.10 Gardens and trees
- ▶ 1.5.11 Satellite dishes, aerials and site facilities

The controls in this section are to be read in conjunction with the controls in:

- ▶ Section C1.3 Building type; and
- ▶ Section C1.4 General controls for all development.

### C1.5.1 Dormers and skylights

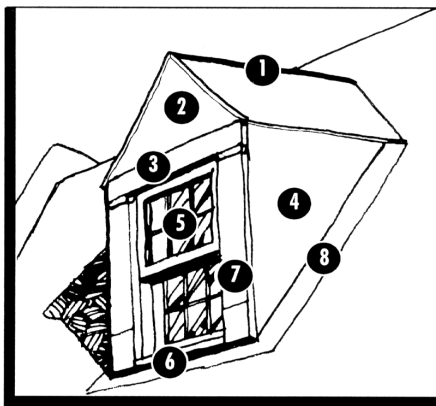
Adaptation of the roof void areas of the principal building forms of Victorian and Federation period dwellings was a traditional building method to increase the area available for bedrooms. Typically light and ventilation was provided to these attic level rooms by constructing a dormer window located vertically within the principal roof planes.

Notwithstanding, more numerous are the houses which exist without dormers to the street front elevations. Dormers to the street front significantly alter the character of the streetscape. Skylights located in highly visible positions, large skylights and skylights with protruding profiles can also detract from Paddington's roofscape.

Current pressures for accommodation make the use of the roof space desirable. Where the principal roof form has sufficient slope and height an attic room may be possible with a dormer in the rear slope of the principal roof form.

Using the roof space is possible if the original ceilings are retained, except where interrupted by a new stair or ladder access. To maintain the consistency of new dormers, traditional models for Victorian and Federation period buildings, with specific proportions and dimensions, are provided in this section.

**FIGURE 12** Dormer - typical elements



- 1 Dormer roof
- 2 Pediment
- 3 Lintel
- 4 Cheek
- 5 Double hung window
- 6 Sill
- 7 Pilaster
- 8 Flashing

#### Objectives

- O1 To minimise the impact of dormers and skylights on the form, appearance and fabric of the principal roof form.
- O2 To ensure that dormers to Victorian and Federation period terraces and cottages are traditional in form, proportions, scale and materials.
- O3 To ensure that new attic spaces do not unnecessarily impact on original significant fabric, especially original ceilings.

## Controls

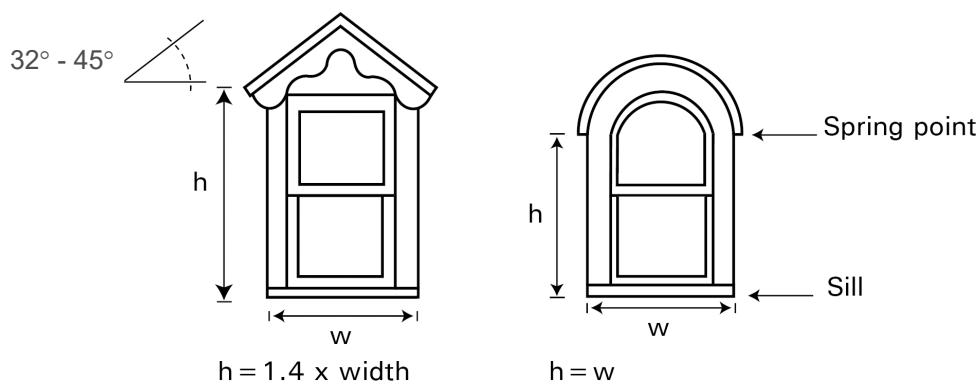
### *Dormers - general*

- C1 Dormers must not be added to street front and side elevations of the principal form of contributory buildings unless documentary evidence sufficiently shows that an original dormer or dormers existed in these locations as part of the original design. In these instances the design of the reconstructed dormer window is to conform to the documentary evidence.
- C2 Attic spaces in a Victorian or Federation period building that contributes to the significance of Paddington may be permitted if the original ceiling to the principal form remains intact except for the provision of a stair or access ladder.
- C3 A dormer may be located within the rear slope of the principal roof form only if this would have no impact or negligible impact on:
  - a) the architectural integrity and style of the main roof form;
  - b) the building's significance;
  - c) the group's significance, where the building forms part of a group; and
  - d) the significance of the heritage conservation area.
- C4 More than one dormer may be located within the rear slope of the principal roof form subject to:
  - a) the width of the roof being greater than 6m;
  - b) each dormer being identical in type, size and no greater than 1.2m maximum width overall; and
  - c) consideration of the impact on the building's significance, on the group's significance where the building forms part of a group, and on the streetscape.
- C5 The design, proportions and materials of new dormers, where permitted, must be based on traditional models and must be appropriate to the architectural style of the building and the building's context (see Figures 13 and 14).
- C6 Dormers must be arranged symmetrically on the roof plane.
- C7 Dormers must not incorporate balconies, balconets or Juliet balconies.
- C8 Pediment infill and side cheeks to traditional and contemporary dormers must not be glazed.
- C9 Pediments may be infilled with flush fitting timber ventilators.

*Dormers to Victorian period cottages, semi-detached dwellings and terraces*

- C10 For buildings 4m wide or wider, a dormer, or each dormer where more than one is possible due to roof width, must not exceed 1.2m in width.
- C11 Where buildings are less than 4m wide, a single dormer must not exceed one third of the width of the roof or 1m overall, whichever is the lesser.
- C12 For a dormer with a pitched roof:
- the height of a window is to be 1.4 times its width, as measured from the head of the window to the bottom of the sill; and
  - the roof pitch is to be between 32° and 45°.
- C13 For a round headed dormer, the height of a window measured from the bottom of the sill to the springing point of the rounded head is to be equal to the overall width of the dormer.
- C14 The top of a dormer must be below the main roof ridge by at least 300mm.
- C15 The top of the dormer window sill must be set at least 400mm above the finished floor level.
- C16 The roof of the dormer must be clad with corrugated metal sheeting and flashing that matches the existing roof colour. The roof sheeting and bargeboard must not exceed a 150mm overhang. Dormers must have a timber pilaster facing and no wall cladding below the sill. Cheeks must be clad in timber weatherboards.
- C17 Where dormers are reconstructed on street front elevations (as allowed under C1), they must use traditional windows appropriate to the building style. Documentary evidence must be provided to support the appropriateness of the window type.

**FIGURE 13** Traditional 'Victorian' period dormers

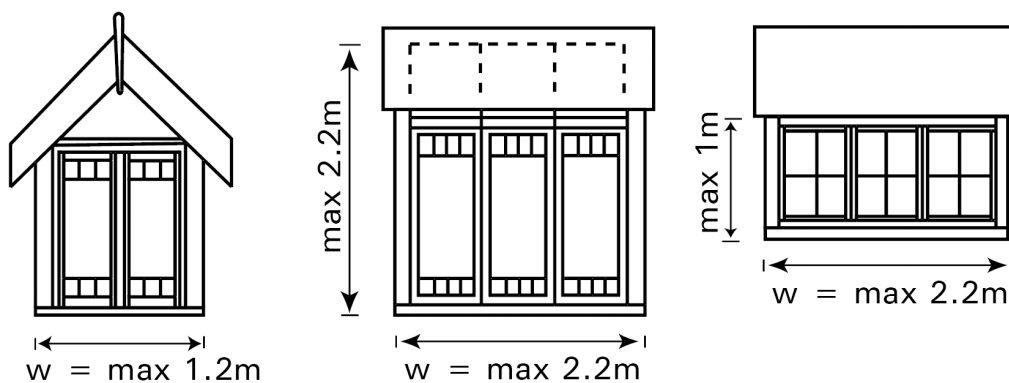


*Dormers to Federation period cottages, semi-detached dwellings and terraces*

- C18 Dormers to Federation period contributory buildings should be appropriate to the architectural style of the building.

- C19 Vertically proportioned Victorian period dormers with double hung or casement windows are permitted if they comply with the proportions and location of C10 or C11, and C12 to C15.
- C20 Horizontally proportioned dormers with casement windows are permitted with eyelid or hipped roof forms if:
- designed appropriately to the building's type;
  - the top of the dormer is located at least 600mm below the main roof ridge line;
  - the top of the sill is set at least 900mm above the gutter line;
  - the dormer width is limited to 2.2m;
  - the window height is limited to 1m maximum or 2.2m maximum depending on the window type (see Figure 14); and
  - the dormer complies with Figure 14.

**FIGURE 14** Federation period dormers



*Dormers to infill buildings*

- C21 A contemporary styled dormer may be located within the rear roof plane of the principal roof form of an infill building where:
- there would be no impact or negligible impact on the heritage significance of the adjoining buildings and on the significance of the heritage conservation area;
  - the proportions comply with C10 or C11, and C12 to C15; and
  - the provisions of C6, C7, C8 and C9 are met.
- C22 More than one dormer may be located within the rear slope of the principal roof form subject to:
- the width of the roof being greater than 6m;
  - each dormer being identical in type, size and no greater than 1200mm maximum width overall;

- c) the height of each dormer complying with C12 to C15;
- d) the provisions of C6, C7, C8 and C9 being met; and
- e) consideration of the impact on the significance of the adjoining properties and on the streetscape.

### *Skylights*

- C23 Skylights are not to be placed in front or side facing roofs of the principal roof form.
- C24 A single skylight may be placed in the rear facing slope of the principal roof form by itself, or with a single dormer.
- C25 A maximum of two skylights may be placed in the rear facing slope of the principal roof form provided:
- a) they are arranged symmetrically; and
  - b) there is no dormer.
- C26 Two skylights may only be placed non-symmetrically where it can be demonstrated that their location is essential to internal amenity.
- C27 No skylights may be placed in the rear facing slope of the principal roof form where there are two or more dormers.
- C28 Skylights must be of a low profile and should be flush with the roof surface. They should have simple, unobtrusive detailing and be non-reflective. Colouring must merge with the roofing material.
- C29 A skylight on the principal roof form is to not to exceed an area greater than 1.5m<sup>2</sup>.
- C30 Rear roof planes are not to incorporate more than 25% transparent material. This includes the area of skylights and dormer windows.

## C1.5.2 Chimneys

---

Chimneys are important elements within the heritage conservation area. They add vertical emphasis to the roofscape and richness by the variety of forms and detail.

### **Objectives**

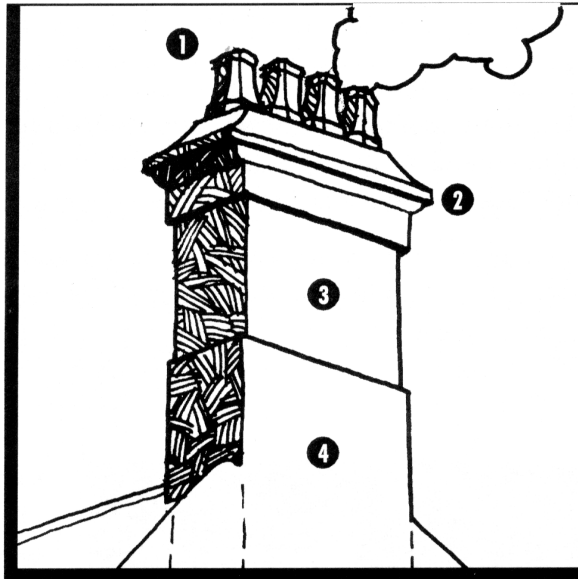
- O1 To retain and conserve original chimneys and their details.
- O2 To encourage reinstatement of missing chimney elements.

### **Controls**

- C1 Original chimneys and their details must be retained.

- C2 When works are proposed to the roof of the principal form of the building, missing details from existing chimneys, where substantiated by evidence, are to be reinstated and repairs to existing chimneys are to be undertaken in a traditional manner.

**FIGURE 15** Typical chimney stack



- 1 Chimney pot
- 2 Coped and moulded cornice
- 3 Shaft
- 4 Stump

### C1.5.3 Windows, doors, shutters and security

The majority of window types available in the late 19th and early 20th century were double hung timber framed sashes. Windows were commonly rectangular in shape and vertically proportioned. Where a larger opening was desired, windows were set in groups. Rear windows were vertically proportioned and relatively plain.

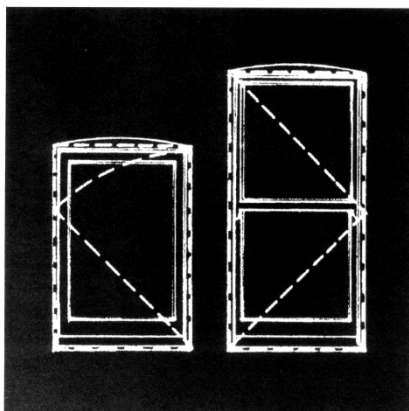
Casement windows became fashionable in the early 20th century. Often these were grouped in threes. Glazing bars, glazing and the number of panes reflected stylistic fashions and advances in the manufacture of the size of sheets of glass. Both casements and double hung windows were sometimes embellished with coloured and patterned glass. This decorative treatment is usually located on the street front location. Rear glazing is comparatively plain.

The front door was the most elaborately detailed timber door of the house. Commonly it featured moulded and recessed panels and good quality hardware. The quality and level of detail diminished in secondary areas of the house. Doors to verandahs at the first floor level were usually timber French doors with solid lower panels.

Louvered timber shutters were commonly used for windows and doors to assist with cooling buildings and providing privacy and security. In two storied or higher buildings, shutters might only have been fitted to the ground floor windows and French doors.

Security devices which conceal the windows and doors to the street front elevations of a building adversely affect the visual character of the building.

**FIGURE 16** New windows



**Window 1**

**Window 2**

Traditional vertical proportions of fenestration should be maintained. New windows should be vertical in proportion, preferably within the range suggested. The width of a window should not be greater than the height given by the radius of the diagonal, as shown on **Window 1**. The height of the window should not exceed twice the width, as shown in **Window 2**.

These controls are applicable for new windows in existing walls and additions to existing buildings. Greater freedom of interpretation is permitted for infill development.



## Objectives

- O1 To retain and conserve original windows, and doors and their associated detailing and joinery components including original shutters on significant elevations of the principal building form, such as street fronts and side elevations facing streets.
- O2 To reinstate traditional windows, doors, and shutters consistent with the architectural style of the building on significant elevations facing streets.
- O3 To retain the visual prominence of windows and door openings visible from the public domain.

## Controls

### *Windows and doors*

- C1 Original windows, doors and shutters on the elevations of the principal building form and side elevations facing the street are to be retained.
- C2 When works are proposed to the street front elevations on the principal building form and on side elevations facing the street, unsympathetic windows and doors on those elevations are to be removed and replaced with windows and doors that are consistent with traditional elements of known earlier configuration in terms of size, proportion, materials and detail.
- C3 Traditional shutters to windows and French doors should be reinstated where they have been known to exist previously where visible from the public domain.
- C4 New doors and window openings must be consistent with traditional materials and patterns, use vertically proportioned openings appropriate to the building type and comply with Section 1.4.3 Rear elevations, rear additions, significant outbuildings and yards.
- C5 Where rear wings are extended boundary to boundary at the ground floor, new doors and windows must be vertically proportioned, but may use contemporary detailing.
- C6 New doors replacing a rear window opening at the upper level of a rear wing are to be limited to the size of a set of traditional French doors.

### *Security*

- C7 Security should be provided by the least obtrusive method such as the use of mortice deadlocks, window and door locks, an alarm system or internal security bars, internal timber window shutters or security film attached to the internal face of glazing, and other measures in preference to external security grilles.
- C8 External metal security doors and window grilles are permitted where they use simple, unembellished, rectangular bars in a vertical pattern or a pattern that reflects the configuration of the glazing bars, and are painted in recessive colours that match the colour of the door or window frame.

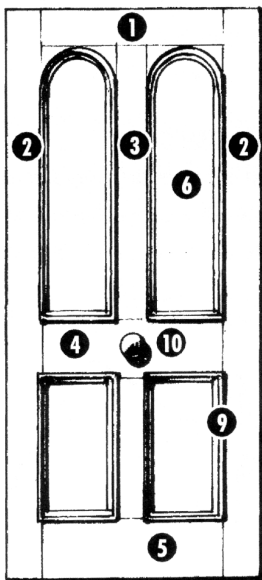
- C9 Highly visible grilles embellished with pseudo period detail over windows and doors are not permitted.
- C10 Roller shutters will not be permitted to windows or doors.
- C11 Motorised window sunscreens are permitted only to ground floor windows not visible from the public domain.

### Door types

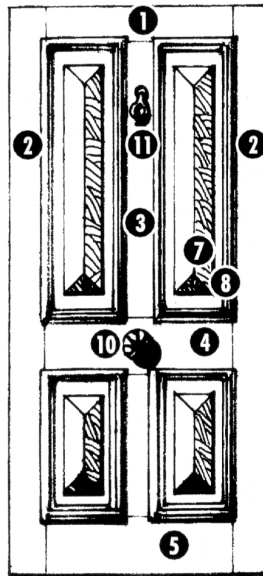
Some common examples of front doors are shown. All are panelled doors with stiles and rails. Type A and Type B are four panel doors, while Type C is a high-waisted Edwardian door.

**FIGURE 17** Door types

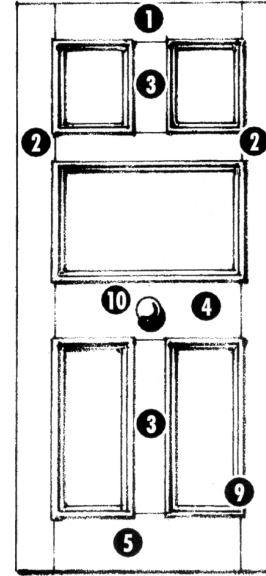
**Type A – Mid Victorian**



**Type B – Late Victorian**



**Type C – Edwardian**



Some common examples of front doors are shown. All are panelled doors with stiles and rails. Type A and Type B are four panel doors, while Type C is a high-waisted Edwardian door.

- 1 Top rail
- 2 Stile
- 3 Muntin
- 4 Mid rail
- 5 Bottom rail
- 6 Sunken panel
- 7 Raised field panel
- 8 Bolection mould
- 9 Lamb's tongue mould
- 10 Knob
- 11 Knocker

### C1.5.4 Verandahs and balconies

Many buildings obtain their visual interest from verandahs and balconies, which create a strong pattern of light and shade by their projection, decorative timber or cast iron and the covering balcony roof. Verandahs that are traditionally located on the front elevation are an important element in the streetscape and should be conserved.

Note: Balconies associated with dormers are not permitted, as addressed in Section 1.5.1 Dormers and skylights.

**FIGURE 18** Verandahs and balconies



- 1 Ogee gutter
- 2 Timber mouldings
- 3 Cast iron lace frieze
- 4 Handrail
- 5 Cast iron lace balustrade panel
- 6 Balcony timber floor
- 7 Bead moulding
- 8 Dentils
- 9 Stop-chamfered verandah beam
- 10 Cast iron frieze panel
- 11 Stop-chamfered frieze
- 12 Cast iron lace frieze
- 13 Cast iron bracket
- 14 Fin wall

**FIGURE 19** Types of balconies

**Suspended balcony**

Usually present on Georgian or early Victorian terraces and restored



**Balcony between fin walls**

Typical for mid or late Victorian and Edwardian terraces



**Enclosed balconies**

Enclosed balconies are intrusive and they should be re-opened



---

## Objectives

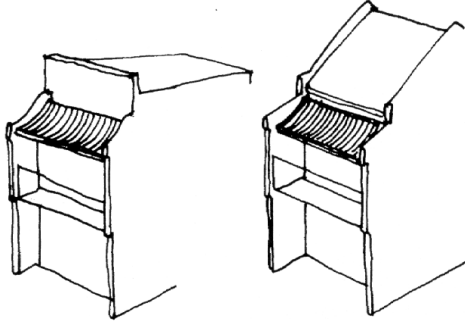
- O1 To retain and conserve original verandahs and balconies and their associated detailing and components.
- O2 To encourage the reinstatement of traditional open balconies and verandahs where verandahs and balconies have been altered or removed.
- O3 To promote sympathetic contemporary design of new rear balconies and verandahs that responds to the historic character of the area.

## Controls

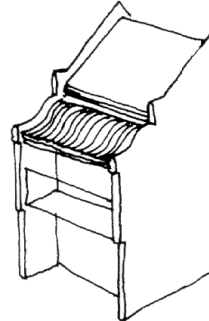
- C1 Original verandahs and balconies are not to be altered except for the reinstatement of original detail, and the reversal of unsympathetic alterations. Patterns of replacement cast iron should be based on physical or documentary evidence of original cast iron elements on the building or in the group.
- C2 Verandahs and balconies may be reinstated where they have been known to exist at an earlier date. The design must be consistent with the architectural style, materials and detailing of the building and the group, where the building is part of a group.
- C3 The step down from the main roof to the balcony roof must be retained or reinstated where a new or replacement balcony or reinstatement of a balcony is proposed.
- C4 The heights of original balustrade panels and rails must conform to the heights of original and appropriate balustrades within Paddington. Balustrade heights may only be increased by inserting a fine horizontal bar above the existing balustrade, supported behind the existing balustrade.
- C5 New verandahs and balconies are not permitted at the upper levels if the building is part of an unaltered group of buildings.
- C6 If the building is part of an altered group of buildings, a rear balcony is permitted where:
  - a) the original rear window opening is widened to a maximum of 1.2m to accommodate a pair of traditionally scaled French doors;
  - b) the balcony width does not exceed the width of the door opening by more than 300mm and must not have a depth greater than 600mm;
  - c) the balcony is a similar form to a traditional balcony, but is detailed in a contemporary manner; and
  - d) a glass balustrade is not used.
- C7 New rear upper floor balconies and verandahs must be designed with regard to the amenity of adjoining and adjacent properties. Privacy screens may be required to reduce the impact of new balconies.
- C8 Verandahs and balconies on infill buildings must be of a contemporary design and materials that demonstrate an appropriate response to the relevant aspects of the historic context.

**FIGURE 20** Balcony roofs

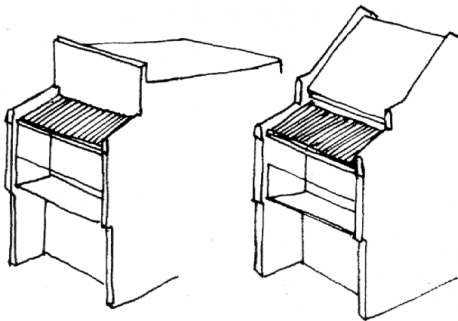
**Concave balcony roof**  
Convex was also common



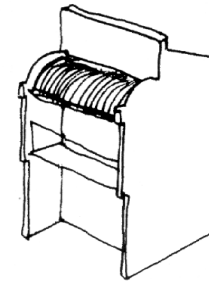
**Ogee balcony roof**  
This form is often reversed



**Skillion balcony roof**  
This form is rare on late Victorian terraces

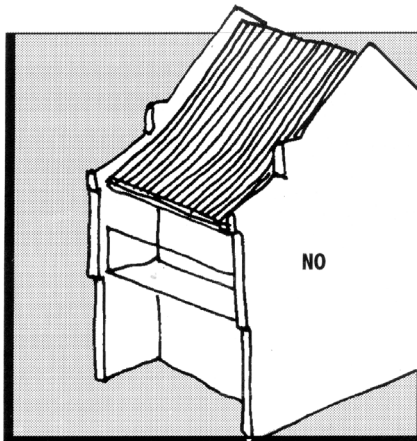


**Bullnosed balcony roof**  
This form is common on late Victorian terraces



**FIGURE 21** Intrusive balcony roof

In the 50s and 60s many terraces were re-roofed, mainly using terracotta or concrete tiles, removing the separation between the roof and the main balcony roof. Renovators are encouraged to reverse this intrusive trend.



---

### C1.5.5 Fences, walls and gates

---

In Paddington, the majority of houses with a setback from the street originally had a front fence. As well as performing the usual range of functions the fence presented the household to the street. Through pickets and iron palisade fences the passer-by could obtain glimpses of gardens and the house.

Each architectural period or building type had an associated style of fence, so the materials and the design of the front fencing varied. Typical Victorian terraces had an iron palisade fence on a sandstone base. Cottages often had a timber picket fence.

Front fences enriched the visual appeal to the street. Side and rear fences were usually rough sawn timber palings or brick and performed a utilitarian function.

Fences play an important role in forming the character of a house. A well designed fence will complement and enhance the qualities of a building. Too often the appeal of a house will be considerably diminished by a fence of inappropriate design and materials. The blank masonry fence on the street front elevation is an example of an unsympathetic fencing type.

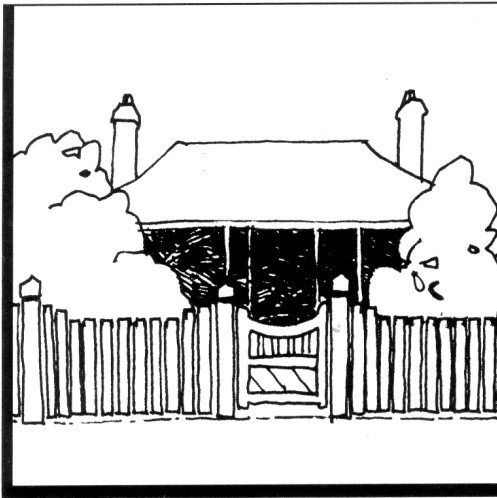
Where groups of buildings were elevated, a boundary wall was constructed using local sandstone, with a traditional fence on top. Often these changes in level occurred beside old quarry sites. Where these street walls are high, they form significant townscape elements.

Note: For garage doors and associated gates refer also to Section 1.5.6 On-site vehicle parking, garages, carports, driveway access and servicing facilities.

#### Objectives

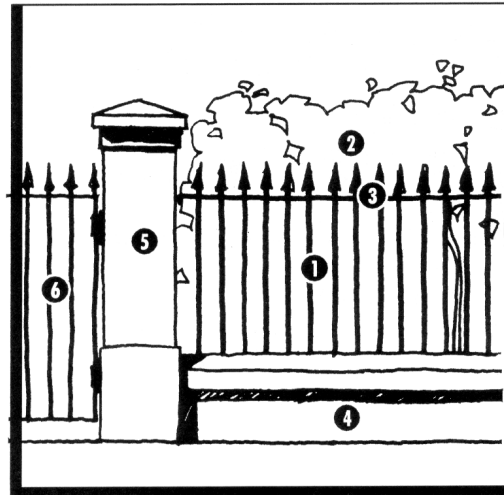
- 01 To retain and conserve original fences and gates.
- 02 To reinstate traditional fences and gates on street frontages and side streets of an appropriate architectural style to existing buildings.
- 03 To maintain traditional heights of fences and their elements.
- 04 To ensure fences and gates for infill development respond in a contemporary manner to the relevant aspects of the historic context.
- 05 To retain views towards the rear of properties from the laneways or over side fences.
- 06 To ensure fences are built with regard to the topography of sloping sites.
- 07 To ensure boundary fences between allotments provide visual privacy without adversely affecting the amenity of adjoining properties in terms of views and sunlight.
- 08 To retain and conserve significant sandstone walls.

**FIGURE 22** Picket fences



Early Colonial and Edwardian buildings are associated with timber picket fences. Picket designs varied from Colonial times through to Edwardian times from small rounded tops, to scalloped, spear-ended and flat tops.

**FIGURE 23** Palisade fence



Detailing of iron palisade fences varied from Colonial to early 20th century times.

- 1 Iron palisade bar
- 2 Iron spearhead top
- 3 Top rail
- 4 Coped masonry plinth
- 5 Masonry pier
- 6 Iron gate

## Controls

### *General - all areas*

- C1 Fences and gates must be constructed to the boundary or, where the adjoining owner's consent has been obtained, on the boundary (except for public land where no encroachment must occur).
- C2 Gates must not encroach over or onto public land when opening and closing.
- C3 Gates must be constructed in line with fences.
- C4 The configuration, finishes and details of original sandstone walls must be retained and conserved. Alterations for the purpose of maintenance, reinstatement or reinstatement of missing elements may occur.



*Street front zone*

- C5 There is to be no alteration to original fences and gates, except for maintenance, reconstruction or the reinstatement of missing elements.
- C6 Unsympathetic fences, walls and gates must be removed and replaced by fences, walls and gates that are of the form, height, details, materials, finishes and quality appropriate to the architectural character of the building and group, where the building forms part of a group.
- C7 New and replacement fences and gates must be consistent with the architectural style of the building and be an appropriate traditional height. If part of a group, a fence must match the original fence in the group.
- C8 In the street front zone, traditional types of fencing permitted for Victorian or Federation buildings comprise one or a combination of the following:
- a) iron or steel palisades on sandstone or rendered bases;
  - v) timber pickets; and
  - w) low brick fences (for Federation type buildings).
- C9 The configuration, finishes and details of original sandstone retaining walls located in the street front zone are to be retained and conserved.
- C10 Breaching an original sandstone retaining wall to incorporate an opening for parking is not permitted.
- C11 New or replacement fences must incorporate root barriers at the street front boundary where street trees occur.
- C12 On corner sites, new fences and gates must allow good visibility for pedestrian and vehicular traffic. This may be achieved by low fences and gates or designs with at least 50% transparency.
- C13 Fences and gates on infill sites should be a contemporary design and of a form, height, detail, finish and materials that demonstrate an appropriate response to the physical and historical context of the streetscape.



**FIGURE 24** Palisade fence in the streetscape



Palisade fences were common for Victorian terraces

**FIGURE 25** Boundary masonry fence



Contemporary high masonry walls as front fences are intrusive in the streetscape and they are not permitted

*Side boundary*

- C14 Side boundary fencing must be consistent with traditional fence, forms and materials.
- C15 The height of side boundary fencing is not to exceed 1.8m.
- C16 On sloping sites, the height of side boundary fences may be averaged and fences may be regularly stepped.

*Rear boundary and side street*

- C17 New fences and gates to side and rear streets and rear lanes are to be of a design and height, and are to use materials and details, which are consistent with the building's context and with the controls contained in Table 4 and in Section 1.5.8 Materials, finishes and details.

**TABLE 5** Rear boundary and side street fence and gate controls

	Scale	Materials
<b>Fences</b>	<ul style="list-style-type: none"> <li>▶ Side street fence maximum height of 1800mm, unless building is designed to face both front and side streets.</li> <li>▶ Side street fence where building is designed to face both front and side, maximum height consistent with architectural style of building and appropriate traditional height.</li> <li>▶ Rear fence maximum height 1800mm.</li> </ul>	<ul style="list-style-type: none"> <li>▶ Rear and side fences should be timber palings.</li> <li>▶ Fully transparent or semi-transparent materials such as lattice are not permitted.</li> <li>▶ Palisade fences to side streets may be permitted where the building is designed to face both front and side streets.</li> <li>▶ Bagged or rendered brick walls may be permitted if appropriate to the context.</li> </ul>
<b>Rear street or laneway gates</b>	<ul style="list-style-type: none"> <li>▶ Maximum gate height 1800mm.</li> <li>▶ Maximum gate width 1200mm.</li> <li>▶ Minimum gate width 900mm.</li> <li>▶ Maximum double gates width 2400mm.</li> </ul>	<ul style="list-style-type: none"> <li>▶ Lugged and braced timber gates.</li> <li>▶ Timber painted bi-fold gates.</li> </ul>
<b>Side street gates</b>	<ul style="list-style-type: none"> <li>▶ Maximum gate height 1800mm, unless lower height required to match fence height for building designed to face both front and side streets.</li> <li>▶ Maximum gate width 1200mm.</li> <li>▶ Double gates maximum width 2400mm.</li> <li>▶ Minimum gate width for pedestrian gates 900mm.</li> </ul>	<ul style="list-style-type: none"> <li>▶ Materials to relate to context.</li> <li>▶ Palisade style gate where palisade fence used.</li> </ul>

---

### C1.5.6 On-site vehicle parking, garages, carports, driveway access and servicing facilities

---

Garages, carports and onsite parking areas for motor vehicles were not elements incorporated into Victorian buildings and their sites. Garages emerged as a building structure with the advent of the motor vehicle just prior to World War I. By the 1930s garages were proliferating and being constructed on the street frontages and rear lanes. Garages were generally of a size allowing single car access only and were treated as secondary or utilitarian buildings with little embellishment. During the late 1960s, double garage doors and roller shutters and carports became common. Two car families and the desire for vehicle security have created pressure for large garages and car spaces within sites in Paddington.

The rear lanes of Paddington are now often lined with garage doors and brick walls. They form an impenetrable and unattractive barrier between private gardens and the public spaces, and have an adverse effect on the character and use of laneways. Their height and mass prevent views towards the rear of buildings, whose forms contribute to the character of the lane. There is an alienation of the pedestrian in these spaces. High solid walls and fences on the rear boundaries can also provide opportunities to screen burglars. This section of the DCP aims to readdress the treatment of these forms.

The demands for car spaces have resulted in a reduction of landscaped area and useable open space to the rear of properties. Consequently, there has been a reduction in trees and a loss of permeable surface, which is increasing the pressure on surface drainage systems. Additionally sandstone kerbing, which forms part of the laneway character, has been removed to provide driveway crossovers.

The pressure for parking has also resulted in proposals for alternate means of providing onsite parking. One alternative involves the use of car stackers. There may be certain circumstances where a stacker arrangement may be acceptable due to the existing site and context characteristics and the scale and form of an existing building. However, generally car stackers are not acceptable in Paddington. Stackers require a substantial surge in electrical power to operate and are therefore environmentally unacceptable, lead to vehicles queuing in laneways and streets due to delays in operating the stacker system which can cause impacts on traffic and pedestrian movements, generally require out of scale garage structures to accommodate the stackers, and involve excessive excavation for basement stackers.

#### Objectives

- 01 To conserve original elements and structures on street frontages and laneway boundaries, including coach houses, stables and rear lane toilets.
  - 02 To ensure that contributory buildings rather than vehicular access and parking structures remain the dominant element in the streetscape.
  - 03 To improve the character of laneways where unsympathetic earlier development such as high brick walls and full width garages has eroded the quality of these urban spaces.
  - 04 To ensure that the designs of garages, carports, fences and gates are sympathetic in their massing, form and scale to the relevant aspects of the historic context and setting of the building and allow visual connectivity to the principal building form of a significant group.
-

- 
- O5 To encourage development that is scaled for the pedestrian in terms of height, articulation and modulation.
  - O6 To provide off street car parking and servicing facilities where feasible.
  - O7 To retain sandstone kerbing on streets and laneways where feasible.
  - O8 To ensure that the amount and quality of deep soil landscaped area and private open space are not compromised by providing on-site parking and servicing areas.
  - O9 To minimise vehicle and pedestrian conflicts.
  - O10 To ensure there is no net loss of vehicle parking spaces in the area.
  - O11 To ensure that use and quantity of on street parking spaces is not adversely affected.
  - O12 To prevent vehicle car stackers.
  - O13 To minimise overshadowing, loss of privacy and the impact of building bulk on adjoining properties.
  - O14 To minimise excavation.

## Controls

### *General*

- C1 Onsite parking areas, parking structures and servicing areas such as loading facilities are not a mandatory requirement. In addition, and subject to circumstances listed in the following controls, on-site parking will only be permitted or may only be required where:
  - a) the parking area, servicing area or structure will not have a detrimental impact on:
    - the amenity of adjoining properties;
    - the architectural character or significance of a building, including original coach houses, stables or rear lane toilets (where the toilets occur on adjoining properties);
    - the character of a streetscape or laneway; or
    - the health of a significant tree;
  - b) vehicle entries and exits will not have a detrimental impact on pedestrian movements, traffic movements, Council infrastructure or service authority infrastructure;
  - c) the parking area, servicing area or structure will comply with the current Australian Standard 2890.1-2004;
  - d) a driveway will comply with AS 2890.1 - 2004;
  - e) extensive excavation is not required and the excavation controls in Section 1.4.7 are met;
  - f) private open space and deep soil landscaped area controls are met;
  - g) there are adequate sight distances to allow safe vehicle movement into and from the site;

- h) there is no net loss of vehicle parking spaces in the immediate area; and
  - i) the use and quantity of on-street parking spaces is not adversely affected.
- C2 No further vehicle crossings are permitted at street frontages that form part of the street front zone.
- C3 No parking is permitted on that area of the site which forms part of the street front zone or within or beneath the principal building form.
- C4 Vertical car stackers are not permitted.
- C5 The design and location of car parking spaces and structures must allow an 85th percentile vehicle to manoeuvre into and out of a space without the loss of on-street parking opposite or abutting the proposed vehicle entry. This is particularly relevant where the street or lane is less than 5m between kerbs.
- Note: Vehicle turning paths are to be determined in accordance with Australian Standard 2890.1.2004. The 85th percentile vehicle is a standardised vehicle based on the significant characteristics of various vehicle types operating on Australian roads. More information about the 85th percentile vehicle, including its dimensions, can be found in AS 2890.1.2004.
- C6 Garages and carports must comply with the dimensions, settings, forms and materials shown in Tables 5 and 6.

*Street front zone*

- C7 A single uncovered car space, single carport or single garage, may be permitted if:
- a) an approved vehicle crossing exists on the street frontage;
  - x) the existing building is setback from the side boundary which adjoins another building by a minimum of 3m in the case of a proposed uncovered car space or carport, and a greater distance in the case of a proposed garage;
  - y) the car space, carport or garage is setback behind the outer front wall of a building in the street front zone, excluding any projecting balconies or decks; and
  - z) the general controls C1-C6 can be met.
- C8 Where parking is permitted under C7, new garage and carport structures are to be of a design and in materials that respond to the relevant aspects of the historic context. An appropriate contemporary design is permitted and should not be an historic imitation.

*Rear lane or rear street*

- C9 Rear lane or rear street vehicle access and associated on-site parking are permitted if:
- a) the distance from the rear of the building, whether existing or proposed, to the rear boundary is 10m or more;
  - aa) the block width is 3.4m or more;

- 
- bb) the lane or street width between kerbs is 4.8m or more, but if less the applicant can demonstrate to Council that access can be achieved by compliance with C6 and C1(d); and
- cc) the general controls of C1-C6 can be met.
- C10 Where rear lane or street parking is permitted under C9, and the property is 4.7m or more in width, proposals must provide an acceptable interface between the private and public domain by incorporating elements such as pedestrian gates or fencing a minimum of 1200mm wide along rear boundaries. Where possible, gateways on adjoining properties should be grouped.
- C11 Where rear lane or street parking is permitted under C9, double garages, double carports, double car spaces are permitted only where the property is a least 7.1m wide and a 1.2m wide gateway is provided. Structures must not exceed a width of 6m.
- C12 Any loss of on-street parking due to construction of a new driveway access must be compensated by an equivalent number, or more, of onsite parking spaces.
- C13 Laneway garages with roof landscaping are permitted only where:
- a) the property slopes steeply to the rear;
  - dd) the floor level of the roof landscaping is below the floor level of the existing lowest floor of the principal building form;
  - ee) the roof is non-trafficable except for garden maintenance purposes;
  - ff) there is compliance with the deep soil landscaped area requirement; and
  - gg) the roof landscaping area, including planter boxes, parapets and landscaping will not adversely impact on adjoining and adjacent properties.

#### *Residential parking rates*

- C14 For residential parking requirements refer to Chapter E1 Parking and Access.
- C15 Onsite parking must comply with the provisions of C1-C13. Maximum parking may not be permitted where non-compliance with the provisions of C1-C13 will occur.

#### *Retail, commercial and other non-residential parking and servicing rates*

- C16 For retail, commercial and other non-residential development, the average number of onsite parking spaces and servicing facilities must comply with the controls in Chapter E1 Parking and Access.
- C17 Onsite parking and servicing facilities must comply with the provisions of C1-C13. Maximum parking may not be permitted where non-compliance with the provisions of C1-C13 will occur.

**TABLE 6** Dimensions for garages and carports

Rear lane, rear street and existing street-front access locations (unless otherwise specified)

Garage carport type		Width	Height		Door			Piers	
		Max	Max to top parapet <sup>1</sup>	Max wall height below eave	Height	Max width	Min width <sup>2</sup>	Min width	Max width
Garage - flat roof parapet form <sup>3</sup>	Single space	4340	2800	2800	2200	3400	2400	350	470
	Double space	6000	2800	2800	2200	5000	N/A	470	600
Garage - pitched roof form <sup>4</sup>	Single space	4340	N/A	2700	2200	3400	2400	350	470
Garage - with garden roof <sup>5</sup>	Single space	4340	3000	3000	2200	3400	2400	350	470
	Double space	6000	3000	3000	2200	5000	N/A	470	600
Carport - flat roof form <sup>3</sup>	Single space	4340	N/A	2700 <sup>6</sup>	2200	3400	2400	350	470
	Double space	6000	N/A	2700 <sup>6</sup>	2200	5000	N/A	470	600
Carport - pitched roof form <sup>3</sup>	Single space	4340	N/A	2700 <sup>6</sup>	2200	3400	2400	350	470

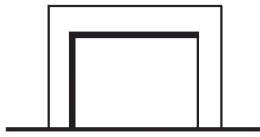
Notes:

All dimensions in millimetres

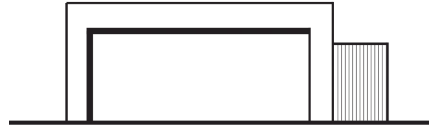
1. Top of parapet from lane or street level
2. Doorway width will vary depending on road/lane width. Refer to C5 in Section 1.5.6. The minimum acceptable doorway width is 2400mm.
3. Double space garage and carport (adjoining or tandem) not permissible in front yard
4. Pitched roof form only permitted for single space garage and single space carport
5. Landscaped roof form only permitted in rear lane and rear street
6. Column or pier height for carport

**FIGURE 26** Garage and carport design diagrams

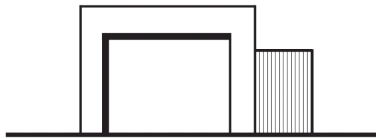
Laneway garage



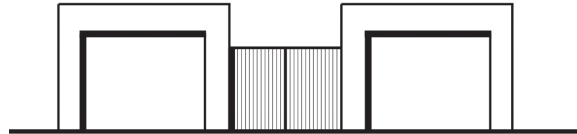
Laneway double garage – with side gate/fence



Laneway garage – with side gate/fence



Grouped garages – with side gates/fences



Laneway garage – with gabled roof form



Laneway garage – with roof garden



**TABLE 7** Setting, form and materials for garages and carports rear street

	Setting	Form	Materials
<b>Rear lane and rear street garages parapet and gabled roof form</b>	<ul style="list-style-type: none"> <li>▶ Build on rear boundary.</li> <li>▶ Minimise ramp up to garage.</li> <li>▶ Provide an acceptable interface on laneway (refer to C10).</li> </ul>	<ul style="list-style-type: none"> <li>▶ Horizontal parapet (flat roof) or pitched roof form.</li> <li>▶ Corner sites to have pitched roof form.</li> <li>▶ Pitched roof to match appropriate traditional roof pitch.</li> <li>▶ Double garages to have horizontal parapet form only.</li> <li>▶ A masonry to door ratio 1:1 is preferred.</li> </ul>	<ul style="list-style-type: none"> <li>▶ Rendered and painted masonry walls.</li> <li>▶ Corrugated steel roofing.</li> <li>▶ Timber or metal bi-fold doors, timber sliding doors, panel-lift doors or roller shutters.</li> <li>▶ Roller shutter and panel lift doors only if set within a masonry surround.</li> <li>▶ Paint finish to all doors (dark colour recommended)</li> </ul>



	Setting	Form	Materials
<b>Rear lane and rear street garages with garden roof</b>	<ul style="list-style-type: none"> <li>▶ Build on rear boundary.</li> <li>▶ Minimise ramp up to garage.</li> <li>▶ Provide an acceptable interface on laneway (refer to C10).</li> </ul>	<ul style="list-style-type: none"> <li>▶ Flat roof form only.</li> </ul>	<ul style="list-style-type: none"> <li>▶ Rendered and painted masonry walls.</li> <li>▶ Concrete slab to roof garden.</li> <li>▶ Timber or metal bi-fold doors, timber sliding doors, panel-lift doors or roller shutters.</li> <li>▶ Roller shutter and panel-lift doors only if set within a masonry surround.</li> <li>▶ Paint finish to all doors (dark colour recommended).</li> <li>▶ Simple timber or metal balustrade set behind masonry parapet if required.</li> </ul>
<b>Rear lane and rear street carport</b>	<ul style="list-style-type: none"> <li>▶ Build on rear boundary.</li> <li>▶ Minimum ramp up to carport.</li> <li>▶ Where site widths allow, a row of more than two carports must be interspersed with fencing or pedestrian gates.</li> </ul>	<ul style="list-style-type: none"> <li>▶ Flat or pitched roof form.</li> </ul>	<ul style="list-style-type: none"> <li>▶ Timber or metal posts or masonry reveals.</li> <li>▶ Timber, metal or masonry fascia.</li> <li>▶ Timber or metal bi-fold doors, timber sliding doors, panel-lift doors or roller shutters.</li> <li>▶ Paint finish to all posts, reveals and fascias.</li> </ul>

	Setting	Form	Materials
<b>Single garage or carport with existing street front zone access</b>	<ul style="list-style-type: none"> <li>▶ Behind outer front wall of building (refer to C8 for other criteria).</li> <li>▶ Minimum ramp up to garage or carport.</li> </ul>	<ul style="list-style-type: none"> <li>▶ Horizontal parapet (flat roof) or pitched roof form.</li> <li>▶ Pitched gabled roof form to match appropriate traditional gable roof pitch.</li> <li>▶ A masonry to door ratio 1:1 is preferred.</li> </ul>	<ul style="list-style-type: none"> <li>▶ Garage walls to be rendered and painted masonry.</li> <li>▶ Roof material to be slate, terracotta tile or corrugated steel appropriate to the building with which the garage or carport is associated.</li> <li>▶ Timber and metal posts to be paint finished.</li> <li>▶ Timber or metal bi-fold doors, panel-lift doors or roller shutters.</li> <li>▶ Roller shutter and panel-lift doors only if set within a masonry surround.</li> <li>▶ Paint finish to all doors (dark colour recommended).</li> </ul>
<b>Rear lane and rear street garage with loft</b>	<ul style="list-style-type: none"> <li>▶ Build on rear boundary.</li> <li>▶ Minimise ramp up to garage.</li> <li>▶ Provide an acceptable interface on laneway or street (refer to C10).</li> </ul>	<ul style="list-style-type: none"> <li>▶ Gable ended to rear laneway, rear street and rear yard along allotment axis.</li> <li>▶ Single loft only.</li> <li>▶ Traditionally proportioned double hung sash windows.</li> <li>▶ Skylights to be flat version.</li> </ul>	<ul style="list-style-type: none"> <li>▶ Rendered and painted masonry walls.</li> <li>▶ Corrugated steel roof.</li> <li>▶ Paint finish to all laneway and street doors (dark colour recommended).</li> <li>▶ Timber windows to loft.</li> </ul>

---

### C1.5.7 Lofts over garages and studios

---

There is a demand for additional structures located over single storey garages and studios located at the rear of properties. Lofts provide benefits such as added accommodation, surveillance to laneways, increased public and private security and safety, and in some instances improvements to a laneway appearance.

However, there are many parts of Paddington where loft structures are inappropriate. To determine whether a loft structure over a single storey garage or a studio would be acceptable, consideration must be given to the significance of the existing rear building form and lot size, the relationship to the adjoining properties, the laneway characteristics where relevant and impacts on privacy.

#### Objectives

- O1 To ensure that loft structures over garages or studios are sympathetic in their location, massing, form and scale to the traditional rear elevations, yards, and laneways.
- O2 To ensure that loft structures over garages or studios do not detract from the significance of unaltered groups of buildings.
- O3 To ensure that loft structures over garages or studios do not impact on the privacy of adjoining properties.
- O4 To ensure that loft structures do not result in a non-compliance with the private open space and deep soil landscaped area requirements.
- O5 To ensure that loft structures are appropriately orientated to minimise overshadowing on adjoining/adjacent open space.
- O6 To minimise the visual impact of loft structures when viewed from public areas and private land.
- O7 To ensure that loft structures above garages and studios do not preclude the maintenance and conservation of items that contribute to the significance of the heritage conservation area.

#### Controls

- C1 Loft structures may be permitted where:
  - a) the site dimensions are a minimum of 30m long and 5.24m wide and where the structure will not adversely impact on the traditional character of the rear elevations, yards, and laneways;
  - b) the structure will not adversely impact on the amenity, visual privacy and overshadowing of the property, neighbouring properties and public open space (the controls in Section 1.4.5 Building height, bulk, form and scale apply);
  - c) the structure does not require the footprint of the garage or studio to be extended so that the controls in Section 1.4.8 Private open space, swimming pools, courtyards and landscaping cannot be satisfied. Where there is an existing non-compliance with

---

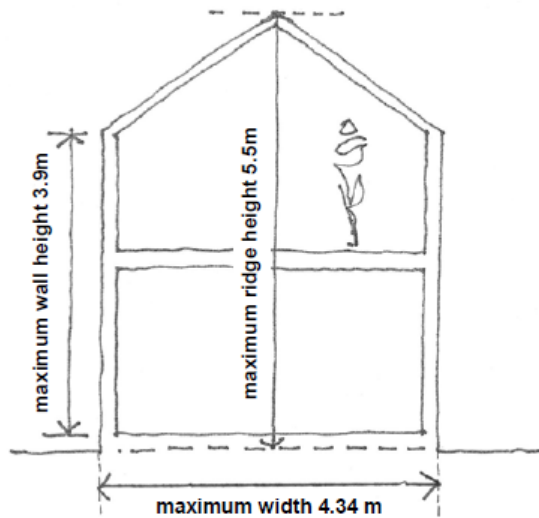
these controls, the existing private open space and deep soil landscaping is not to be further reduced;

- d) all access to the loft is provided internally;
- e) habitable room windows within the loft with a direct sightline to the habitable room windows in the existing building on the site and neighbouring buildings have a separation distance of at least 9m;
- f) the structure extends over only a single space garage or studio;
- g) the loft and garage (or studio) structure is a maximum of 4.34m wide;
- h) the roof structure is gable ended to the rear boundary, with a maximum ridge height of 5.5m and maximum wall height of 3.9m (on or adjacent to a side boundary);
- i) windows are located only in the centre of gable ends and must be either: a single double hung sash window, or inward opening window of traditional proportions;
- j) does not include balconies, decks, or other similar cantilevered structures;
- k) a maximum of two skylights per roof plane, provided they comply with controls C28, C29 and C30 in Section 1.5.1 Dormers and skylights;
- l) the ground floor level of the principal building form is higher than the natural ground level at the rear boundary; and
- m) the maintenance of elements that contribute to the heritage conservation area, such as sandstone walls, will not be adversely affected. Also refer to C1.5.6 Fences, walls and gates.

C2 Loft structures will not be permitted:

- a) over garages or studios in the street front zone;
- hh) if the subject property is part of an original row of houses, comprising an unaltered group, and the proposal demonstrates an adverse impact on this group;
- ii) if the rear of the property is orientated towards the north between NNE and NNW (true north) (see Appendix 1);
- jj) with a dormer window; and
- kk) over a multiple space garage.

**FIGURE 27** Loft structure design example including dimensions



### C1.5.8 Materials, finishes and details

Buildings in Paddington were constructed from a distinct and limited range of materials. Similarly, there is a pronounced repetition of detailing in surface treatments and building components.

Materials, finishes and detailing are two important elements which unite the area and contribute to Paddington’s character. The repetitive combination of materials and the manner in which they were used for specific parts of buildings also forms part of Paddington’s significant character.

The use of modern day materials and contemporary design approaches can be successfully employed in Paddington provided the relevant aspects of context are respected.

The table following the objectives and controls below sets out traditional external materials found within Paddington. It lists materials suitable for new development, alterations and additions. Additionally it lists materials which are intrusive elements, either by their very nature or if used in inappropriate situations.

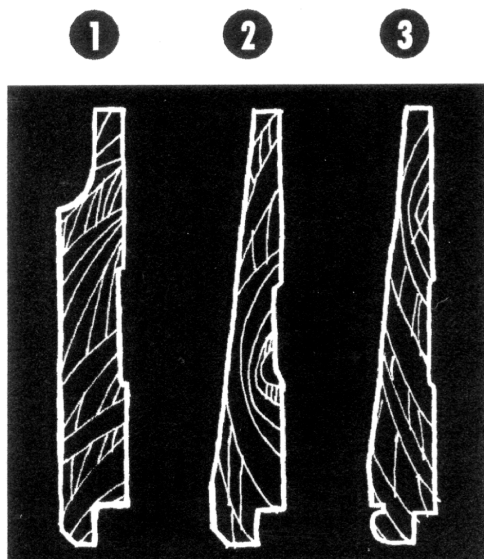
#### Objectives

- O1 To retain and conserve traditional materials, finishes and details.
- O2 To promote high quality design, materials, finishes and detailing which is appropriate to the architectural style, building type, and historic context.
- O3 To conserve original external finishes.

## Controls

- C1 Surviving original materials, finishes, textures and details on street front elevations are to be retained and conserved.
- C2 Original brickwork, sandstone, terracotta, glazed or tessellated tiling that is unpainted or unfinished by other mediums must not be rendered, bagged, painted or otherwise refinished in a manner inappropriate to the architectural style of the building.
- C3 Render must not be removed from the exterior face of buildings unless it is proposed to re-render the surface immediately. Where original render has been removed from the exterior face of a building, new render must be applied and painted. Special consideration will be given to a building in a group.
- C4 New materials, finishes, textures and details on the principal building form and elevations visible from a public space, must be traditional and appropriate to the architectural style of the building. Intrusive materials are not permitted.
- Table 8 below sets out traditional external materials found within Paddington and those materials permissible for new development, including alterations and additions.
- C5 New external materials and details to additions must complement the architectural character of the existing building and minimise the apparent bulk of the addition.
- C6 Infill buildings must use materials, finishes, textures and details appropriate to the building type and style but should not replicate traditional details.

**FIGURE 28** Traditional cladding profiles



- 1 Rusticated weatherboard
- 2 Chamfered boarding
- 3 Beaded boarding

**TABLE 8** Materials and details

Building component	External building materials
<b>Roofs</b>	
Traditionally	<ul style="list-style-type: none"> <li>▶ Natural slate such as Welsh slate and South Australian slate. Later Victorian or Edwardian terraces occasionally had traditional ornamental patterns which may have been in contrasting colours.</li> <li>▶ Corrugated galvanised iron in short lengths and associated details and fixings.</li> <li>▶ Unglazed terracotta tiles on Federation period buildings and post- Federation buildings.</li> </ul>
New roofs to existing buildings - replacement and additions (including courtyard housing additions and lofts over garages)	<ul style="list-style-type: none"> <li>▶ Galvanised corrugated steel with associated galvanized gutter details and fixings.</li> <li>▶ Pre-painted corrugated steel in light to mid grey tones, similar in appearance to traditional corrugated iron.</li> <li>▶ Traditional roof materials as outlined above.</li> </ul>
Intrusive roofs for existing buildings - replacement and additions	<ul style="list-style-type: none"> <li>▶ Concrete roof tiles.</li> <li>▶ Metal roofing sheets or panels in inappropriate colours.</li> <li>▶ Non-traditional metal roof profiles.</li> <li>▶ Terracotta tiles on pre-Federation period buildings.</li> <li>▶ Glass (other than permitted in skylights).</li> </ul>
<b>Walls</b>	
Traditionally	<ul style="list-style-type: none"> <li>▶ Sandstone blocks for walls or as a base course to brick walls.</li> <li>▶ Timber weatherboards (depending on the building type). The profiles vary depending on the construction date.</li> <li>▶ Brick, which was usually rendered in Victorian era buildings and was often inscribed with ashlar coursing.</li> <li>▶ Face brickwork on Edwardian and late Federation style buildings. The associated details may include tuck pointing on the principal elevation and areas of roughcast render.</li> <li>▶ Corrugated galvanised iron, zinc coated corrugated steel ripple iron and weatherboards on sides of dormer windows and outbuildings.</li> </ul>

Building component	External building materials
New walls to additions	<ul style="list-style-type: none"> <li>▶ Traditional wall materials including sandstone blocks, timber weatherboard or brick.</li> <li>▶ Corrugated galvanised iron, zinc coated corrugated steel ripple iron for small expanses only. Must be in appropriate colours and subject to low reflectivity.</li> <li>▶ Rendered brick, with or without inscribed ashlar coursing where appropriate.</li> <li>▶ Fibrous cement sheeting with a rendered and painted finish - for rear additions but only if window reveals of minimum 100mm external depth are achieved.</li> </ul>
Intrusive walls for existing buildings and additions	<ul style="list-style-type: none"> <li>▶ Stripped sandstock brickwork.</li> <li>▶ Circular pattern render (mock Spanish)</li> <li>▶ Glazed walls and glass bricks.</li> <li>▶ Metal wall cladding.</li> <li>▶ Metal mesh or perforated metal screens.</li> </ul>
<b>Windows</b>	
Traditionally	<ul style="list-style-type: none"> <li>▶ Timber framed, double hung sash windows, plain or multi-paned windows.</li> <li>▶ Plain glass, traditional patterned or coloured glass in some building types.</li> </ul>
New windows to existing building (replacement and additions)	<ul style="list-style-type: none"> <li>▶ Timber frames.</li> <li>▶ Steel frames on rear ground floor only.</li> <li>▶ Metal frames for ground floor shops and commercial premises where appropriate.</li> <li>▶ Plain clear glass.</li> <li>▶ Coloured and patterned glass for replacement in appropriate situations.</li> <li>▶ Fine metal frames in neutral tones.</li> </ul>



Building component	External building materials
Intrusive windows	<ul style="list-style-type: none"> <li>▶ Metal frames (including steel) to the principal building form and original secondary wings.</li> <li>▶ Window walls.</li> <li>▶ Bubble glass.</li> <li>▶ Glass blocks.</li> <li>▶ Timber or metal frames not reflecting traditional proportions.</li> <li>▶ Roller shutter security and sunscreen windows.</li> <li>▶ Horizontally sliding windows.</li> <li>▶ Aluminium framed windows in the front elevation and at the upper levels at the rear.</li> </ul>
<b>Doors</b>	
Traditionally	<ul style="list-style-type: none"> <li>▶ Timber solid core; principal doors are often panelled; utilitarian doors are often ledged and braced.</li> <li>▶ Etched or frosted glass in the top panels of late Victorian style doors and small coloured glass panes in Federation style doors.</li> </ul>
New doors to existing building (replacement and additions)	<ul style="list-style-type: none"> <li>▶ Solid core framed timber panelled doors to match original doors are required for reconstruction work.</li> <li>▶ Solid core timber framed, glazed timber-framed doors, glazed steel frame in appropriate locations.</li> </ul>
Intrusive doors	<ul style="list-style-type: none"> <li>▶ Fully glazed doors to the street front elevation of residential properties.</li> <li>▶ Hollow core and timber doors with detail and panels inappropriate to the architectural style of the building.</li> <li>▶ Roller shutter doors to residential houses, retail and commercial premises.</li> </ul>
<b>Shutters</b>	
	<ul style="list-style-type: none"> <li>▶ Traditionally detailed timber louvred shutters are applicable for windows and French doors on some building types.</li> </ul>
<b>Verandahs</b>	
Traditionally	<ul style="list-style-type: none"> <li>▶ Floors of stone flagging, marble, unglazed multi-coloured tessellated tiles.</li> <li>▶ Slate, timber and sandstone edging.</li> <li>▶ Cast iron posts of a flat profile or circular in section, cast iron friezes.</li> <li>▶ Timber posts and associated timber details for early Victorian buildings and Federation period buildings.</li> </ul>

Building component	External building materials
New verandahs - reconstruction	<ul style="list-style-type: none"> <li>▶ Traditional materials for reconstruction.</li> <li>▶ Materials similar to traditional materials but without elaborate detailing.</li> </ul>
Intrusive verandahs	<ul style="list-style-type: none"> <li>▶ Pebble-crete, modern concrete, large form modern tiles for original building types.</li> <li>▶ Polycarbonate or similar type material roofs.</li> <li>▶ Glass roofs to street elevations.</li> </ul>
<b>Balconies</b>	
Traditionally	<ul style="list-style-type: none"> <li>▶ Corrugated iron or slate roofs where appropriate to the style of the building.</li> <li>▶ Timber for floors and timber framing for the underside of verandah roofs.</li> <li>▶ Cast iron friezes and balustrade panels with iron or timber handrails for Victorian period buildings.</li> <li>▶ Timber balustrades for early Victorian buildings and Federation period buildings.</li> </ul>
New balconies - reconstruction	<ul style="list-style-type: none"> <li>▶ As with traditional materials for reconstruction on original building types or with modern-day equivalents.</li> <li>▶ Masonry and metal, other than perforated metal or mesh screens.</li> <li>▶ Reuse of salvaged cast iron friezes and balustrade panels with iron or timber handrails.</li> </ul>
Intrusive balcony materials	<ul style="list-style-type: none"> <li>▶ Smooth, textured or profiled face brick and exposed cement blocks.</li> <li>▶ Corrugated and other profiled metal sheeting.</li> <li>▶ Wire fencing.</li> <li>▶ Fibrous cement sheeting.</li> <li>▶ Glass balustrading.</li> <li>▶ Perforated metal or mesh screens.</li> </ul>

Building component	External building materials
<b>Fences</b>	
Traditionally	<ul style="list-style-type: none"> <li>▶ Occasionally rendered masonry with inscribed ashlar coursing.</li> <li>▶ Timber post, rail and paling.</li> <li>▶ Iron palisade, on sandstone or rendered bases.</li> <li>▶ Timber pickets.</li> <li>▶ Brick and timber fences or brick with iron inserts on Federation period buildings.</li> </ul>
New fences - additions	<ul style="list-style-type: none"> <li>▶ As with traditional fences but with consideration to building style and context.</li> <li>▶ Appropriate traditional materials for reinstatement of fences on original building types.</li> <li>▶ Contemporary interpretation of traditional fence details and materials such as iron palisade and timber.</li> </ul>
Intrusive fences	<ul style="list-style-type: none"> <li>▶ Smooth, textured or profiled face brick, exposed cement blocks, Ti Tree (brush), colourbond or sheet metal fences.</li> <li>▶ Full height brick fences.</li> <li>▶ Materials and forms that are inappropriate to the style of the building.</li> </ul>

Materials and details for infill development are provided in Table 2 in C1.3.13 - Infill development.

---

### C1.5.9 Exterior colours

---

Colour schemes make important contributions to the character of individual buildings and groups of buildings. Colour schemes can influence the cohesiveness of a group of buildings and an entire streetscape. They can be used to enhance important building features and reduce intrusive features. The use of historic based colour schemes is appropriate where an original colour scheme contributed to the architectural style of a building.

Exterior colours used on buildings constructed between 1850-1895 and 1895-1915, and even during the Inter-War period were from a comparatively narrow range. These colours were used to enhance the architectural style and to enhance the natural colours of construction materials. A range of exterior colours was used on buildings constructed in the early, mid and late Victorian period and in the Edwardian period. Colours were often used to enhance the architectural style and to highlight particular features and building components.

In determining a colour scheme the architectural style of the building must be considered. Georgian style buildings tended to have simply decorated exterior surfaces with only two or three colours. By the late Victorian period, when buildings were designed with a profusion of decoration, six or eight colours may have been used. Edwardian and Federation buildings used one or two lighter tones with a darker contrasting colour to enhance the unpainted brickwork. A wider range of colour finishes and a higher level of gloss were used for door and window joinery, verandah posts, valances, bargeboards and ornamental work.

For signwriting, trimmings and metal finishes typical colours included light brown, rich brown, Indian red, chrome green, and in rare instances Prussian blue, black and dark tints, and slate grey.

Special roof paints were available in the 19th century in a variety of colours. Common colours for roofs that were originally painted were light stone, slate grey and Indian red. Original colour schemes may be determined by the careful scraping of protected difficult to paint areas. They may survive under hardware, behind eaves, under window sills and on the more protected elevations of a building. Care should be taken to distinguish layers of paint finishes from undercoats.

Old photographs can provide valuable evidence of the original paint treatment, particularly in regard to the use of contrasting colours and tonal relationships for the various elements of the building.

## Objectives

- O1 To promote colour schemes that are appropriate to the character of the individual buildings, groups of buildings, the historic context.

## Controls

- C1 Colour schemes must be appropriate to the building type and style.
- C2 The use of fluorescent paints and primary colours are not permitted.
- C3 New buildings and additions in both the residential and commercial areas are to use colour schemes that have hue and tonal relationships with traditional colour schemes.
- C4 The intensity and hue of colour must relate to the style of the building and the streetscape context.
- C5 The whole face of the dividing party wall between attached buildings including terraces must be painted one colour. Painting with different colours to the centreline of a party wall is not permitted.
- C6 Matching buildings in a terrace row must be painted colours that are consistent in tone with the group.
- C7 Where terraces step down a hill, the colour of the front elevations of a terrace and its lower party wall including the return face and chimney above the roof line must be the same colour.
- C8 Where terraces are set back in plan, the forward terrace must be the colour of the exposed party wall, including the return face, up to the adjacent party wall.
- C9 Where it is proposed to introduce new exterior paint colours or modify the existing external paint scheme a colour board to be submitted to Council.

Note: Section 1.5.8 Materials, finishes and details specifies that original brickwork, sandstone, terracotta, glazed or tessellated tiling that is unpainted or unfinished by other mediums must not be rendered, bagged, painted or otherwise refinished in a manner inappropriate to the architectural style of the building.

---

### C1.5.10 Gardens and trees

---

The private gardens in Paddington have a considerable effect on the townscape quality. Both streets and lanes are enhanced by significant landscaping from adjacent private properties. Development, including excavation and landfill, can impact on the conditions in which trees grow. Remnant established gardens, parks and street trees make an important contribution to the character of the area.

#### Objectives

- O1 To retain traditional planting schemes and hard landscape elements where they exist.
- O2 To promote landscaping that is consistent with the character of the individual building, the characteristics of a group of distinctive buildings and the character of the heritage conservation area.
- O3 To ensure that front gardens are planted with a species selection that relates to the building type and is appropriate to the size and aspect of the garden space.
- O4 To create zones of rear planting with appropriate species of trees and shrubs.
- O5 To ensure that trees and shrubs do not have an adverse impact on the fabric of buildings and do not have an unreasonable impact on the amenity of occupiers or properties such that would warrant refusal or modification.

#### Controls

- C1 Significant gardens, or remnants of gardens with original planting schemes and hard landscape elements, such as paving and associated decorative elements, are not to be removed.
- C2 Significant trees are to be retained in place.
- C3 Front gardens should include original pathways and low formal planting which is appropriate to the building type, and allows views of the street front elevation to be maintained.
- C4 Rear gardens are to include one medium sized tree.
- C5 New trees must be a species which is suitable for a Paddington garden. The tree selection should have regard to matters such as size and orientation of the garden.
- C6 Excavation and landfill must not impact on the current and future health of significant trees that are located on the development site or on adjoining sites.

---

### C1.5.11 Satellite dishes, aerials, air conditioning units and other site facilities

---

Paddington's roofscape is an integral component of its overall significance. The introduction of unsympathetic and uncharacteristic elements such as satellite dishes, aerials and air-conditioning units and external condensers can have a detrimental impact on the aesthetic significance of individual buildings and on the area generally.

The fixing of these structures on roofs and chimneys can also contribute to physical damage and possible loss of original fabric and detail.

The location and design of other site facilities such as fire safety systems, mail boxes, external storage facilities, clothes drying areas and laundry facilities can also have a detrimental impact on the appearance and character of the area and must be carefully considered.

Note: Solar energy systems such as photovoltaic electricity generating systems, solar hot water systems, or solar air heating systems are addressed in Chapter E6, Section 6.3 Solar energy systems.

#### Objectives

- 01 To retain the character of the original roofscape of Paddington.
- 02 To protect the original fabric and details of roofs and chimneys.
- 03 To ensure that satellite dishes, air handling systems, external hot water heaters, air conditioning units, aerials, fire safety systems and other site facilities do not detrimentally impact on the character and significance of individual buildings and the streetscape.
- 04 To minimise visual and acoustic impacts on adjoining properties.

#### Controls

##### *Satellite dishes, aerials and similar devices*

- C1 Satellite dishes, aerials and other similar devices:
  - a) are to be designed and scaled to minimise their visual impact and impact on the amenity of adjoining properties;
  - b) must not be located on any part of a roof or chimney which is visible from the street frontage or the public domain; and
  - c) must not have a detrimental impact on the architectural style or significance of the building to which they are attached.

##### *Air conditioning units, condensers and other mechanical plant equipment*

- C2 Air conditioning units, condensers and other mechanical plant equipment in infill development or substantial additions must be located internally within the building.

- 
- C3 Any part of an air conditioning unit, condenser and any other mechanical plant equipment located externally must be located:
- d) behind the outer front wall of the building and not be visible from the public domain;
  - e) less than 1.8m above existing ground level or a basement level or part underground level (but not on a roof); and
  - f) to minimise noise impacts on adjoining properties.
- C4 Air conditioning units, condensers and other mechanical plant equipment must be wholly contained within the permissible building envelope and not be visible from an adjoining property whilst being suitably located, designed, sized, enclosed, concealed, screened and/or otherwise integrated with the building.
- C5 External conduits must not exceed 3m in length and must not be visible from the public domain.
- C6 Condensers, units and conduits must not have a detrimental impact on the architectural style or significance of the building to which they are attached.

*Internal air conditioning systems and packaged air conditioning systems*

- C7 Any associated wall opening must be:
- a) behind the front setback and not be visible from the public domain; and
  - ll) no higher than 600mm above the ground level abutting the wall containing the new opening.

*Fire safety systems*

- C8 Hydraulic fire services such as fire hydrants and booster installations must be concealed. These services are to be:
- a) enclosed with doors if located in the building façade, or
  - b) housed in a cabinet or enclosure if located external to the building.
- The location, design, colour and material of the doors, cabinet or enclosure must be visually unobtrusive and suitably integrated with the development, including fencing and landscaping.

*Electricity substations*

- C9 An electrical substation is to be suitably located, screened and/or concealed so it is not visible from the street, or any other adjoining public place. Council's preference is for a chamber substation. Any screening or enclosure to conceal the substation is to be visually unobtrusive and suitably integrated with the development, including the fencing and landscape design.
- C10 The substation is to be located away from neighbouring properties or sufficiently screened from neighbouring properties.
- C11 The location and design of the electricity substation must be considered and integrated with the landscaping of the proposed development, and must ensure that:



- a) Vegetation does not overhang or encroach within the substation site.
- b) The substation is installed outside of the mature growth root zone of any trees to be retained, or proposed to be planted, to prevent roots damage to underground cables.

C12 The design and location of all other aboveground utility infrastructure (such as electrical pillars etc.) should minimise visual clutter within the streetscape and provide for a continuous accessible path of travel, where practical to ensure safe and equitable pedestrian circulation for people of all abilities. (Where this provision and Ausgrid's requirements cannot both be satisfied, the applicant is to develop in consultation with Council and Ausgrid a solution that meets the acceptance of both consent authorities.)

Notes:

- At the DA stage the applicant should demonstrate that they have engaged with Ausgrid and have a network capacity assessment undertaken for the proposed development.
- Where a substation is required, the substation should be identified on the DA plans and addressed in the *SEPP 65 Design Verification Statement* (also see Apartment Design Guide Objective 3C-2 Amenity of the public domain is retained and enhanced)
- The DCP requirements for substations apply in addition to the Ausgrid Network Standards, such as *NS113 Site selection and construction design requirements for chamber substations*. Separate Ausgrid approval for the substation will be required.
- A dedicated access way/easement through the site to the substation will also need to be provided in accordance with the requirements of Ausgrid and Council.

*Other Site facilities*

C13 Site facilities, including mail boxes, external storage facilities, clothes drying areas and laundry facilities, must be unobtrusively integrated into new development.

Note: Information relating to specific requirements for garbage and recycling is in Part E of this DCP, Chapter E5 Waste Management and in Council's DA Guide.

## C1.6 Public domain

The public domain describes those areas of land owned and/or managed by Council or other public authorities. The public domain includes roadways, gutters, kerbs, footpaths, street name inlays, retaining walls, landscaped verges and reserves, natural landforms and other elements located beyond private property boundaries.

Historically, the streetscapes of Paddington were characterised by a restricted use of materials, including paving, kerbing, street trees and street furniture. The simplicity of this palette allowed the built form to dominate, with embellishment being restricted to the often intricate detailing within the architecture.

The public domain plays a significant role in determining the overall character of the HCA. In addition to the following provisions, the general development objectives and controls in Section C1.4 also apply within the public domain.

### C1.6.1 Kerbs and gutters

The texture and colour provided by the sandstone kerbs and gutters in Paddington is an important characteristic of many streets and further defines the simplicity of the street geometry. Sandstone kerbs and gutters were deliberately introduced by the Paddington Council after 1871 as part of a works program aimed at improving the standard of public roads. These features therefore have historical and social significance as well as aesthetic significance.

#### Objectives

- 01 To retain the original sandstone kerbs and gutters.
- 02 To limit the range of materials used in kerbs and gutters to sandstone and concrete.
- 03 To ensure a homogeneity of colour and texture in materials when introducing or replacing kerbs and gutters.
- 04 To replace existing sandstone kerbs at the end of their useful life with new sandstone kerbs.
- 05 To re-establish sandstone kerbs and gutters where possible.

#### Controls

- C1 All original sandstone kerbs and gutters should be retained and, where possible, reinstated. If sandstone kerbs and gutters are required to be removed (for example in instances of new crossovers) they should be stockpiled for reuse in new works.
- C2 Where new sandstone kerbing is used it should be detailed to match the existing kerbing.
- C3 Where concrete kerbs are to be used, preference should be for precast segmental elements.

- C4 Damaged original sandstone kerbs and gutters should be restored where possible or replaced with new sandstone kerbs and gutters.
- C5 Vehicle crossings and chicanes are discouraged as they interrupt the original line of the streets and sandstone kerbing.
- C6 Maintain the line of kerbs parallel to the building line to preserve the character of the streets.
- C7 Where footpaths are widened, original sandstone kerbs should be left in their original position so that the earlier street form can be understood.
- C8 The profile of all new kerbs should reflect the traditional kerb detail.

---

## C1.6.2 Views and vistas

---

Paddington is characterised by panoramic views and closed vistas. Panoramic views result from the suburb's dramatic topography and position in relation to the harbour and City skyline.

The closed vistas are created by the street configuration which is strongly defined by the terraces with their zero setbacks from street and lane junctions.

The skylines along the southern and eastern edge of the heritage conservation area are formed by the profile of buildings on the Oxford Street and Jersey Road ridges. Landmarks do not feature on the horizon with notable exceptions such as the Royal Hospital for Women chimney and occasional contemporary multi-storey buildings.

Downhill panoramic views from points west of Cascade Street can extend as far as the Harbour especially from elevated viewpoints. Views of the harbour do not occur from points below the level of the Scottish Hospital or from east of Cascade Street.

Views of the City skyline and especially known landmarks such as Centrepoint Tower can be seen from many of the streets with east-west and north-west orientation. Views towards Paddington from New South Head Road and from the ridge along Jersey Road are panoramic and reveal the close-textured fabric of Paddington.

Closed vistas are characterised by the stepped alignments of terrace houses following a change in street direction or up a slope and punctuated by gable walls and corner shops on corners. The closed vista skyline is notable for the fine serrated profile of gabled parapet walls and chimney stacks.

### Objectives

- O1 To retain existing vistas and create opportunities for new views where possible.
- O2 To ensure street tree planting enhances views both to and from Paddington.

### Controls

- C1 New development and street tree planting should respect existing view corridors.
- C2 New development in the public and private domain should be designed and located to minimise the impact on existing vistas or improve existing vistas where possible.
- C3 Removal of trees and demolition of contributory buildings, in whole or part, for the sole reason of creating or improving views and vistas will not be supported.

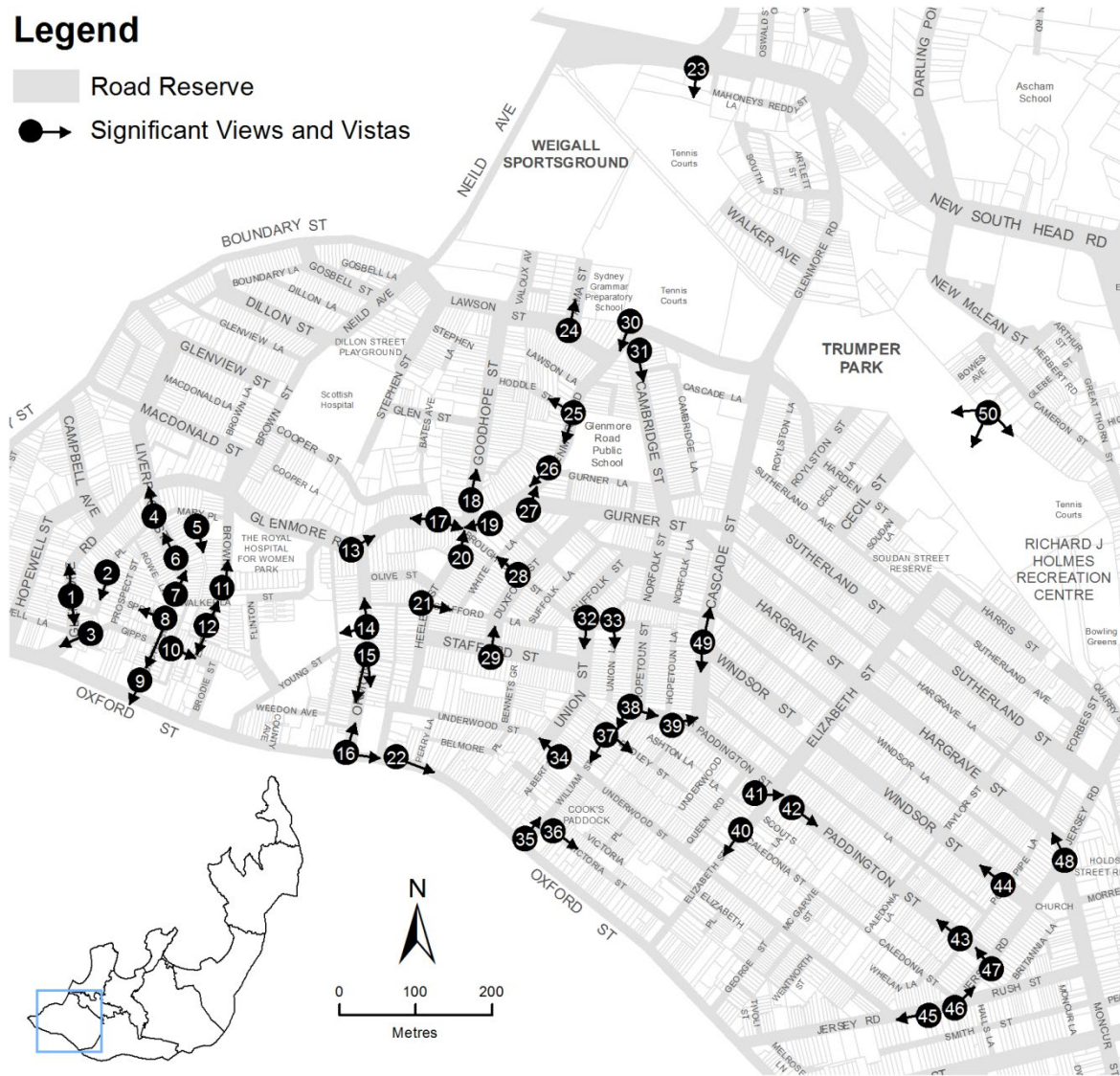
Significant views and vistas

MAP 2 Significant views and vistas

Note: The following diagrams show a selection of significant views and vistas. These diagrams are not intended to represent all the significant views and vistas.

Legend

- Road Reserve
- Significant Views and Vistas

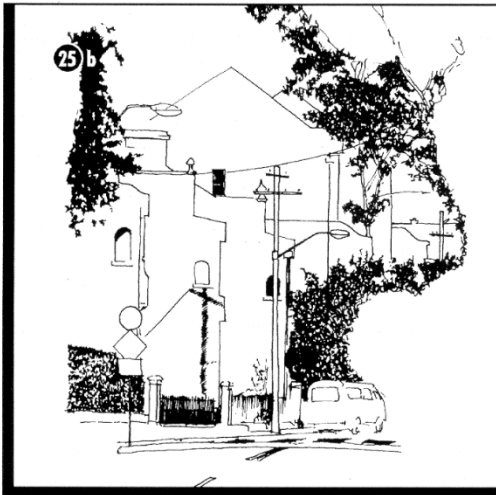
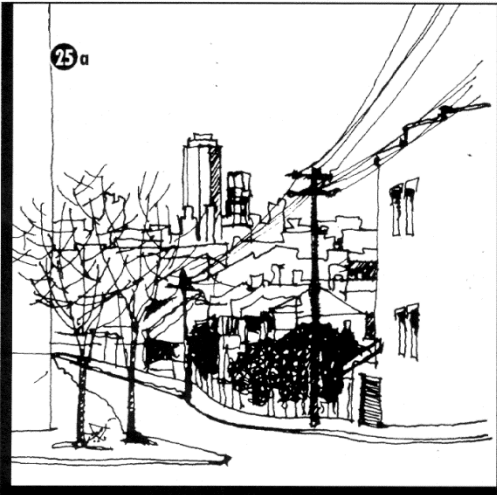
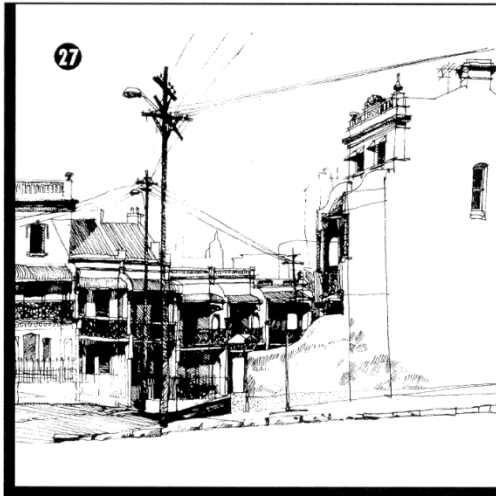
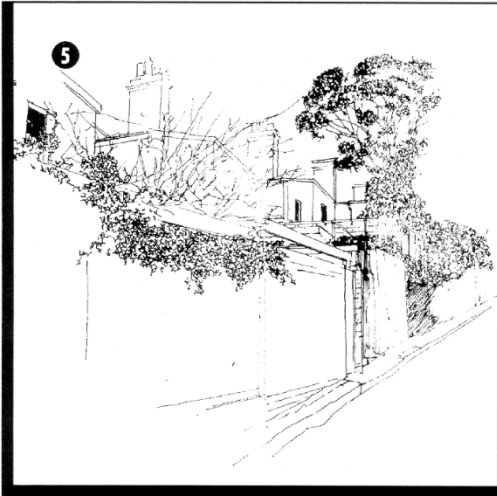




### Significant views and vistas

- 1 (a) Glenmore Road - View north from Mary Place  
(b) Glenmore Road - View south to Gipps St corner
- 2 Mary Place - View south
- 3 Gipps St - View to Oxford St from Bethel Lane
- 4 Liverpool St - View north from Mary Place
- 5 Laneway west of Brown St - View from Mary Place
- 6 Liverpool St - View north
- 7 Liverpool St - View north from Rowe Lane
- 8 (a) Spring St - View from Shadforth St to Prospect St  
(b) Shadforth St - View to Oxford St from Spring St
- 9 Shadforth St - View to Oxford St from Gipps St
- 10 Gipps St - View east from MacLaughlin Pl
- 11 Brown St - View north from Walker Lane
- 12 (a) Alfred St - View from Walker Lane to the south  
(b) Alfred St - View north
- 13 Glenmore Rd - View east from Ormond St
- 14 (a) Ormond St - View north  
(b) Ormond St - View to the front wall of Engehurst
- 15 (a) Ormond St - View south-east  
(b) Ormond St - View south
- 16 (a) Oxford St - Looking west from Ormond St  
(b) Ormond St - View from Oxford St
- 17 (a) Glenmore Rd - View west from Five Ways  
(b) Five Ways - Looking east from Glenmore Rd
- 18 Goodhope St - View north from Five Ways
- 19 Five Ways - View west along Glenmore Rd
- 20 Five Ways - View north from the corner of Heeley St
- 21 Olive St - View from Heeley St
- 22 Oxford St - Looking west from Underwood St
- 23 Paddington from New South Head Rd
- 24 Alma St - View from Lawson St
- 25 (a) Hoddle St - View west from Glenmore Rd  
(b) Glenmore Rd - Looking south from Hoddle St
- 26 Glenmore Rd - Looking south to the corner of Gurner St and Five Ways
- 27 Corner Glenmore and Gurner Rds - Looking north
- 28 Broughton St - View to Five Ways
- 29 Stafford St - View from Duxford St
- 30 Corner of Glenmore Rd and Cambridge St
- 31 Cambridge St - View from Glenmore Rd
- 32 Union St - View from Broughton St
- 33 Union Lane - View from Broughton St
- 34 Underwood St - View from William St
- 35 William St - View north from Victoria St
- 36 Victoria St - View to Elizabeth St
- 37 (a) William St - View from Duxford St looking south  
(b) Dudley St - View from William St
- 38 (a) William St - View south from Paddington St  
(b) Paddington St - View from William St
- 39 Cnr Paddington St and Cascade St - View east from Paddington St
- 40 Elizabeth St - View south from Caledonia St
- 41 Paddington St - Close view from Elizabeth St
- 42 Paddington St - Looking east from Elizabeth St
- 43 Paddington St - View east from Jersey Rd
- 44 Windsor St - View west from Point Piper Lane
- 45 Jersey Rd - Looking south from Underwood St
- 46 Jersey Rd - View north from Rush St
- 47 Cnr Paddington and Jersey Rds
- 48 Cnr Jersey Rd and Hargrave St
- 49 (a) Cascade St - View north from Windsor St  
(b) Cascade St - View south from Windsor Lane
- 50 Trumper Park - Panoramic view







---

### C1.6.3 Public art

---

Paddington has a special cultural, social and educational value associated with the 1950s Bohemian movement and a number of outstanding Australian 20th century artists. The large number of art galleries and resident artists in the suburb are symbolic of Paddington's importance to the art world.

This cultural component of Paddington can be expressed through the incorporation of art works within its public domain.

Although the built form of Paddington maintains a remarkable uniformity, there is a wealth of incidental decoration within the articulation of the buildings. The detailing within a row of terraces was typically the work of a single builder, and as such, this handiwork now stands as a signature of that builder. Similarly, there is a richness of individual expression within the built form of Paddington that could be replicated within public spaces.

Note: Provision of public art is subject to Council's Public Art Policy.

#### Objectives

- O1 To enrich and enliven the experiential quality of the public domain through the provision of high quality works of contemporary art.
- O2 To provide opportunities for professional artists and the community to develop and manifest skills and capabilities.
- O3 To reinforce the unique qualities of Paddington through the provision of site-specific art work.

#### Controls

- C1 Selection of artworks should favour innovation and diversity.
- C2 Opportunities to showcase art by young designers may appear in places where transient displays are appropriate.
- C3 Artwork should have resonance and meaning to the community of Paddington.
- C4 Proposals should be low maintenance and vandal resistant.

## Appendix 1: Orientation of lots in the Paddington HCA

Note: This map is indicative only.

